



8-Channel, 24-Bit ANALOG-TO-DIGITAL CONVERTER

FEATURES

- 24 BITS, NO MISSING CODES
- 0.0015% INL
- 22 BITS EFFECTIVE RESOLUTION (PGA = 1), 19 BITS (PGA = 128)
- PGA FROM 1 TO 128
- SINGLE-CYCLE SETTLING MODE
- PROGRAMMABLE DATA OUTPUT RATES: up to 1kHz
- ON-CHIP 1.25V/2.5V REFERENCE
- EXTERNAL DIFFERENTIAL REFERENCE: 0.1V to 2.5V
- ON-CHIP CALIBRATION
- SPI™-COMPATIBLE
- 2.7V TO 5.25V
- < 1mW POWER CONSUMPTION

APPLICATIONS

- INDUSTRIAL PROCESS CONTROL
- LIQUID/GAS CHROMATOGRAPHY
- BLOOD ANALYSIS
- SMART TRANSMITTERS
- PORTABLE INSTRUMENTATION
- WEIGHT SCALES
- PRESSURE TRANSDUCERS

DESCRIPTION

The ADS1216 is a precision, wide dynamic range, delta-sigma, Analog-to-Digital (A/D) converter with 24-bit resolution operating from 2.7V to 5.25V supplies. The delta-sigma A/D converter provides up to 24 bits of no-missing-code performance and an effective resolution of 22 bits.

The eight input channels are multiplexed. Internal buffering can be selected to provide a very high input impedance for direct connection to transducers or low-level voltage signals. Burnout current sources are provided that allow for the detection of an open or shorted sensor. An 8-bit Digital-to-Analog Converter (DAC) provides an offset correction with a range of 50% of the FSR (Full-Scale Range).

The PGA (Programmable Gain Amplifier) provides selectable gains of 1 to 128 with an effective resolution of 19 bits at a gain of 128. The A/D conversion is accomplished with a second-order delta-sigma modulator and programmable sinc filter. The reference input is differential and can be used for ratiometric cancellation. The onboard current DACs operate independently with the maximum current set by an external resistor.

The serial interface is SPI-compatible. Eight bits of digital I/O are also provided that can be used for input or output. The ADS1216 is designed for high-resolution measurement applications in smart transmitters, industrial process control, weight scales, chromatography, and portable instrumentation.



Please be aware that an important notice concerning availability, standard warranty, and use in critical applications of Texas Instruments semiconductor products and disclaimers thereto appears at the end of this data sheet.

SPI is a trademark of Motorola.

All other trademarks are the property of their respective owners.



This integrated circuit can be damaged by ESD. Texas Instruments recommends that all integrated circuits be handled with appropriate precautions. Failure to observe proper handling and installation procedures can cause damage.

ESD damage can range from subtle performance degradation to complete device failure. Precision integrated circuits may be more susceptible to damage because very small parametric changes could cause the device not to meet its published specifications.

ORDERING INFORMATION

For the most current package and ordering information see the Package Option Addendum at the end of this document, or see the TI web site at www.ti.com.

ABSOLUTE MAXIMUM RATINGS⁽¹⁾

| | ADS1216 | UNIT |
|--------------------------------------|-------------------------------------|-------------|
| AV _{DD} to AGND | –0.3 to +6 | V |
| DV _{DD} to DGND | –0.3 to +6 | V |
| Input Current | 100, Momentary | mA |
| Input Current | 10, Continuous | mA |
| A _{IN} | GND – 0.5 to AV _{DD} + 0.5 | V |
| AV _{DD} to DV _{DD} | –6 to +6 | V |
| AGND to DGND | –0.3 to +0.3 | V |
| Digital Input Voltage to GND | –0.3 to DV _{DD} + 0.3 | V |
| Digital Output Voltage to GND | –0.3 to DV _{DD} + 0.3 | V |
| Maximum Junction Temperature | +150 | °C |
| Operating Temperature Range | –40 to +85 | °C |
| Storage Temperature Range | –60 to +100 | °C |

- (1) Stresses above these ratings may cause permanent damage. Exposure to absolute maximum conditions for extended periods may degrade device reliability. These are stress ratings only, and functional operation of the device at these or any other conditions beyond those specified is not implied.

ELECTRICAL CHARACTERISTICS: $AV_{DD} = +5V$

All specifications at T_{MIN} to T_{MAX} , $AV_{DD} = +5V$, $DV_{DD} = +2.7V$ to $+5.25V$, $f_{MOD} = 19.2kHz$, $PGA = 1$, Buffer ON, $R_{DAC} = 150k\Omega$, $f_{DATA} = 10Hz$, and $V_{REF} = +2.5V$, unless otherwise specified.

| PARAMETER | CONDITIONS | ADS1216 | | | UNIT |
|--|---|-------------|---|-------------------|-----------------------|
| | | MIN | TYP | MAX | |
| ANALOG INPUT ($A_{IN0} - A_{IN7}$, A_{INCOM}) | | | | | |
| Analog input range | Buffer OFF | AGND – 0.1 | | $AV_{DD} + 0.1$ | V |
| | Buffer ON | AGND + 0.05 | | $AV_{DD} - 1.5$ | V |
| Full-scale input voltage range | $(In+) - (In-)$; see Functional Block Diagram | | | $\pm V_{REF}/PGA$ | V |
| Differential input impedance | Buffer OFF | | 5/PGA | | M Ω |
| Input current | Buffer ON | | 0.5 | | nA |
| Bandwidth | | | | | |
| Fast-settling filter | –3dB | | $0.469 \times f_{DATA}$ | | Hz |
| Sinc ² filter | –3dB | | $0.318 \times f_{DATA}$ | | Hz |
| Sinc ³ filter | –3dB | | $0.262 \times f_{DATA}$ | | Hz |
| Programmable gain amplifier | User-selectable gain ranges | 1 | | 128 | |
| Input capacitance | | | 9 | | pF |
| Input leakage current | Modulator OFF, $T_A = +25^\circ C$ | | 5 | | pA |
| Burnout current sources | | | 2 | | μA |
| OFFSET DAC | | | | | |
| Offset DAC range | | | $\pm V_{REF} / (2 \times PGA)$ | | V |
| Offset DAC monotonicity | | 8 | | | Bits |
| Offset DAC gain error | | | ± 10 | | % |
| Offset DAC gain error drift | | | 1 | | ppm/ $^\circ C$ |
| SYSTEM PERFORMANCE | | | | | |
| Resolution | | 24 | | | Bits |
| No missing codes | Sinc ³ filter | | | 24 | Bits |
| Integral nonlinearity | End-point fit | | | ± 0.0015 | % of FS |
| Offset error ⁽¹⁾ | | | 7.5 | | ppm of FS |
| Offset drift ⁽¹⁾ | | | 0.02 | | ppm of FS/ $^\circ C$ |
| Gain error ⁽¹⁾ | | | 0.005 | | % |
| Gain error drift ⁽¹⁾ | | | 0.5 | | ppm/ $^\circ C$ |
| Common-mode rejection | At DC | 100 | | | dB |
| | $f_{CM} = 60Hz$, $f_{DATA} = 10Hz$ | | 130 | | dB |
| | $f_{CM} = 50Hz$, $f_{DATA} = 50Hz$ | | 120 | | dB |
| | $f_{CM} = 60Hz$, $f_{DATA} = 60Hz$ | | 120 | | dB |
| Normal-mode rejection | $f_{SIG} = 50Hz$, $f_{DATA} = 50Hz$ | | 100 | | dB |
| | $f_{SIG} = 60Hz$, $f_{DATA} = 60Hz$ | | 100 | | dB |
| Output noise | | | See Typical Characteristics | | |
| Power-supply rejection | At DC, dB = $-20 \log(\Delta V_{OUT}/\Delta V_{DD})$ ⁽²⁾ | 80 | 95 | | dB |
| VOLTAGE REFERENCE INPUT | | | | | |
| Reference input range | REF IN+, REF IN– | AGND | | AV_{DD} | V |
| V_{REF} | $V_{REF} \equiv (REF IN+) - (REF IN-)$ | 0.1 | 2.5 | 2.6 | V |
| Common-mode rejection | at DC | | 120 | | dB |
| Common-mode rejection | $f_{VREFCM} = 60Hz$, $f_{DATA} = 60Hz$ | | 120 | | dB |
| Bias current ⁽³⁾ | $V_{REF} = 2.5V$ | | 1.3 | | μA |

- (1) Calibration can minimize these errors.
- (2) ΔV_{OUT} is change in digital result.
- (3) 12pF switched capacitor at f_{SAMP} clock frequency.

ELECTRICAL CHARACTERISTICS: AV_{DD} = +5V (continued)

All specifications at T_{MIN} to T_{MAX}, AV_{DD} = +5V, DV_{DD} = +2.7V to +5.25V, f_{MOD} = 19.2kHz, PGA = 1, Buffer ON, R_{DAC} = 150kΩ, f_{DATA} = 10Hz, and V_{REF} = +2.5V, unless otherwise specified.

| PARAMETER | CONDITIONS | ADS1216 | | | UNIT |
|--|--|---|------------|----------------------|------------------|
| | | MIN | TYP | MAX | |
| ON-CHIP VOLTAGE REFERENCE | | | | | |
| Output voltage | REF HI = 1 | 2.4 | 2.5 | 2.6 | V |
| | REF HI = 0 | | 1.25 | | V |
| Short-circuit current source | | | 8 | | mA |
| Short-circuit current sink | | | 50 | | μA |
| Short-circuit duration | Sink or source | | Indefinite | | |
| Drift | | | 15 | | ppm/°C |
| Noise | V _{RCAP} = 0.1μF, BW = 0.1Hz to 100Hz | | 10 | | μV _{PP} |
| Output impedance | Sourcing 100μA | | 3 | | Ω |
| Startup time | | | 50 | | μs |
| IDAC | | | | | |
| Full-scale output current | R _{DAC} = 150kΩ, range = 1 | | 0.5 | | mA |
| | R _{DAC} = 150kΩ, range = 2 | | 1 | | mA |
| | R _{DAC} = 150kΩ, range = 3 | | 2 | | mA |
| | R _{DAC} = 15kΩ, range = 3 | | 20 | | mA |
| Maximum short-circuit current duration | R _{DAC} = 10kΩ | | Indefinite | | |
| | R _{DAC} = 0kΩ | | | 10 | Minute |
| Monotonicity | R _{DAC} = 150kΩ | 8 | | | Bits |
| Compliance voltage | | 0 | | AV _{DD} - 1 | V |
| Output impedance | | See Typical Characteristics | | | |
| Power-supply rejection ratio | V _{OUT} = AV _{DD} /2 | | 400 | | ppm/V |
| Absolute error | Individual IDAC | | 5 | | % |
| Absolute drift | Individual IDAC | | 75 | | ppm/°C |
| Mismatch error | Between IDACs, same range and code | | 0.25 | | % |
| Mismatch drift | Between IDACs, same range and code | | 15 | | ppm/°C |
| POWER-SUPPLY REQUIREMENTS | | | | | |
| Power-supply voltage | AV _{DD} | 4.75 | | 5.25 | V |
| Analog current (I _{ADC} + I _{VREF} + IDAC) | PDWN = 0 or SLEEP | | 1 | | nA |
| ADC current (I _{ADC}) | PGA = 1, buffer OFF | | 140 | 225 | μA |
| | PGA = 128, buffer OFF | | 430 | 650 | μA |
| | PGA = 1, buffer ON | | 180 | 275 | μA |
| | PGA = 128, buffer ON | | 800 | 1250 | μA |
| V _{REF} current (I _{VREF}) | | | 250 | 375 | μA |
| IDAC current (IDAC) | Excludes load current | | 480 | 675 | μA |
| Digital current | Normal mode, DV _{DD} = 5V | | 180 | 275 | μA |
| | SLEEP mode, DV _{DD} = 5V | | 150 | | μA |
| | Read data continuous mode, DV _{DD} = 5V | | 230 | | μA |
| | PDWN | | 1 | | nA |
| Power dissipation | PGA = 1, buffer OFF, REFEN = 0, IDACS OFF, DV _{DD} = 5V | | 1.6 | 2.5 | mW |
| TEMPERATURE RANGE | | | | | |
| Operating | | -40 | | +85 | °C |
| Storage | | -60 | | +100 | °C |

ELECTRICAL CHARACTERISTICS: $AV_{DD} = +3V$

All specifications at T_{MIN} to T_{MAX} , $AV_{DD} = +3V$, $DV_{DD} = +2.7V$ to $+5.25V$, $f_{MOD} = 19.2kHz$, $PGA = 1$, Buffer ON, $R_{DAC} = 75k\Omega$, $f_{DATA} = 10Hz$, and $V_{REF} = +1.25V$, unless otherwise specified.

| PARAMETER | CONDITIONS | ADS1216 | | | UNIT |
|--|---|-------------|---|-------------------|-----------------------|
| | | MIN | TYP | MAX | |
| ANALOG INPUT ($A_{IN0} - A_{IN7}$, A_{INCOM}) | | | | | |
| Analog input range | Buffer OFF | AGND – 0.1 | | $AV_{DD} + 0.1$ | V |
| | Buffer ON | AGND + 0.05 | | $AV_{DD} - 1.5$ | V |
| Full-scale input voltage range | $(In+) - (In-)$; see Functional Block Diagram | | | $\pm V_{REF}/PGA$ | V |
| Input impedance | Buffer OFF | | 5/PGA | | M Ω |
| Input current | Buffer ON | | 0.5 | | nA |
| BANDWIDTH | | | | | |
| Fast-settling filter | –3dB | | $0.469 \times f_{DATA}$ | | Hz |
| Sinc ² filter | –3dB | | $0.318 \times f_{DATA}$ | | Hz |
| Sinc ³ filter | –3dB | | $0.262 \times f_{DATA}$ | | Hz |
| Programmable gain amplifier | User-selectable gain ranges | 1 | | 128 | |
| Input capacitance | | | 9 | | pF |
| Input leakage current | Modulator OFF, $T_A = +25^\circ C$ | | 5 | | pA |
| Burnout current sources | | | 2 | | μA |
| OFFSET DAC | | | | | |
| Offset DAC range | | | $\pm V_{REF} / (2 \times PGA)$ | | V |
| Offset DAC monotonicity | | 8 | | | Bits |
| Offset DAC gain error | | | ± 10 | | % |
| Offset DAC gain error drift | | | 2 | | ppm/ $^\circ C$ |
| SYSTEM PERFORMANCE | | | | | |
| Resolution | | 24 | | | Bits |
| No missing codes | Sinc ³ filter | | | 24 | Bits |
| Integral nonlinearity | End-point fit | | | ± 0.0015 | % of FS |
| Offset error ⁽¹⁾ | | | 15 | | ppm of FS |
| Offset drift ⁽¹⁾ | | | 0.04 | | ppm of FS/ $^\circ C$ |
| Gain error ⁽¹⁾ | | | 0.010 | | % |
| Gain error drift ⁽¹⁾ | | | 1.0 | | ppm/ $^\circ C$ |
| Common-mode rejection | At DC | 100 | | | dB |
| | $f_{CM} = 60Hz$, $f_{DATA} = 10Hz$ | | 130 | | dB |
| | $f_{CM} = 50Hz$, $f_{DATA} = 50Hz$ | | 120 | | dB |
| | $f_{CM} = 60Hz$, $f_{DATA} = 60Hz$ | | 120 | | dB |
| Normal-mode rejection | $f_{SIG} = 50Hz$, $f_{DATA} = 50Hz$ | | 100 | | dB |
| | $f_{SIG} = 60Hz$, $f_{DATA} = 60Hz$ | | 100 | | dB |
| Output noise | | | See Typical Characteristics | | |
| Power-supply rejection | At DC, dB = $-20 \log(\Delta V_{OUT}/\Delta V_{DD})$ ⁽²⁾ | 75 | 90 | | dB |
| VOLTAGE REFERENCE INPUT | | | | | |
| Reference input range | REF IN+, REF IN– | 0 | | AV_{DD} | V |
| V_{REF} | $V_{REF} \equiv (REF IN+) - (REF IN-)$ | 0.1 | 1.25 | 1.3 | V |
| Common-mode rejection | at DC | | 120 | | dB |
| Common-mode rejection | $f_{VREFCM} = 60Hz$, $f_{DATA} = 60Hz$ | | 120 | | dB |
| Bias current ⁽³⁾ | $V_{REF} = 1.25V$ | | 0.65 | | μA |

(1) Calibration can minimize these errors.

(2) ΔV_{OUT} is change in digital result.

(3) 12pF switched capacitor at f_{SAMP} clock frequency.

ELECTRICAL CHARACTERISTICS: AV_{DD} = +3V (continued)

All specifications at T_{MIN} to T_{MAX}, AV_{DD} = +3V, DV_{DD} = +2.7V to +5.25V, f_{MOD} = 19.2kHz, PGA = 1, Buffer ON, R_{DAC} = 75kΩ, f_{DATA} = 10Hz, and V_{REF} = +1.25V, unless otherwise specified.

| PARAMETER | CONDITIONS | ADS1216 | | | UNIT |
|---|--|---|------------|----------------------|------------------|
| | | MIN | TYP | MAX | |
| ON-CHIP VOLTAGE REFERENCE | | | | | |
| Output voltage | REF HI = 0 | 1.2 | 1.25 | 1.3 | V |
| Short-circuit current source | | | 3 | | mA |
| Short-circuit current sink | | | 50 | | μA |
| Short-circuit duration | Sink or source | | Indefinite | | |
| Drift | | | 15 | | ppm/°C |
| Noise | V _{RCAP} = 0.1μF, BW = 0.1Hz to 100Hz | | 10 | | μV _{PP} |
| Output impedance | Sourcing 100μA | | 3 | | Ω |
| Startup time | | | 50 | | μs |
| IDAC | | | | | |
| Full-scale output current | R _{DAC} = 75kΩ, range = 1 | | 0.5 | | mA |
| | R _{DAC} = 75kΩ, range = 2 | | 1 | | mA |
| | R _{DAC} = 75kΩ, range = 3 | | 2 | | mA |
| | R _{DAC} = 15kΩ, range = 3 | | 20 | | mA |
| Maximum short-circuit current duration | R _{DAC} = 10kΩ | | Indefinite | | |
| | R _{DAC} = 0kΩ | | | 10 | Minute |
| Monotonicity | R _{DAC} = 75kΩ | 8 | | | Bits |
| Compliance voltage | | 0 | | AV _{DD} - 1 | V |
| Output impedance | | See Typical Characteristics | | | |
| Power-supply rejection ratio | V _{OUT} = AV _{DD} /2 | | 600 | | ppm/V |
| Absolute error | Individual IDAC | | 5 | | % |
| Absolute drift | Individual IDAC | | 75 | | ppm/°C |
| Mismatch error | Between IDACs, same range and code | | 0.25 | | % |
| Mismatch drift | Between IDACs, same range and code | | 15 | | ppm/°C |
| POWER-SUPPLY REQUIREMENTS | | | | | |
| Power-supply voltage | AV _{DD} | 2.7 | | 3.3 | V |
| Analog current (I _{ADC} + I _{VREF} + I _{DAC}) | PDWN = 0 or SLEEP | | 1 | | nA |
| ADC current (I _{ADC}) | PGA = 1, buffer OFF | | 120 | 200 | μA |
| | PGA = 128, buffer OFF | | 370 | 600 | μA |
| | PGA = 1, buffer ON | | 170 | 250 | μA |
| | PGA = 128, buffer ON | | 750 | 1200 | μA |
| V _{REF} current (I _{VREF}) | | | 250 | 375 | μA |
| IDAC current (I _{DAC}) | Excludes load current | | 480 | 675 | μA |
| Digital current | Normal mode, DV _{DD} = 3V | | 90 | 200 | μA |
| | SLEEP mode, DV _{DD} = 3V | | 75 | | μA |
| | Read data continuous mode, DV _{DD} = 3V | | 113 | | μA |
| | PDWN = 0 | | 1 | | nA |
| Power dissipation | PGA = 1, buffer OFF, REFEN = 0, IDACS OFF, DV _{DD} = 3V | | 0.6 | 1.2 | mW |
| TEMPERATURE RANGE | | | | | |
| Operating | | -40 | | +85 | °C |
| Storage | | -60 | | +100 | °C |

DIGITAL CHARACTERISTICS: T_{MIN} to T_{MAX} , DV_{DD} +2.7V to +5.25V

| PARAMETER | CONDITIONS | ADS1216 | | | UNIT |
|--------------------------------|------------------------|----------------------|------|----------------------|---------------|
| | | MIN | TYP | MAX | |
| Digital input/output | | | | | |
| Logic family | | | CMOS | | |
| Logic level: V_{IH} | | $0.8 \times DV_{DD}$ | | DV_{DD} | V |
| Logic level: V_{IL} | | DGND | | $0.2 \times DV_{DD}$ | V |
| Logic level: V_{OH} | $I_{OH} = 1\text{ mA}$ | $DV_{DD} - 0.4$ | | | V |
| Logic level: V_{OL} | $I_{OL} = 1\text{ mA}$ | DGND | | $DGND + 0.4$ | V |
| Input leakage: I_{IH} | $V_I = DV_{DD}$ | | | 10 | μA |
| Input leakage: I_{IL} | $V_I = 0$ | -10 | | | μA |
| Master clock rate: f_{OSC} | | 1 | | 5 | MHz |
| Master clock period: t_{OSC} | $1/f_{OSC}$ | 200 | | 1000 | ns |

FUNCTIONAL BLOCK DIAGRAM

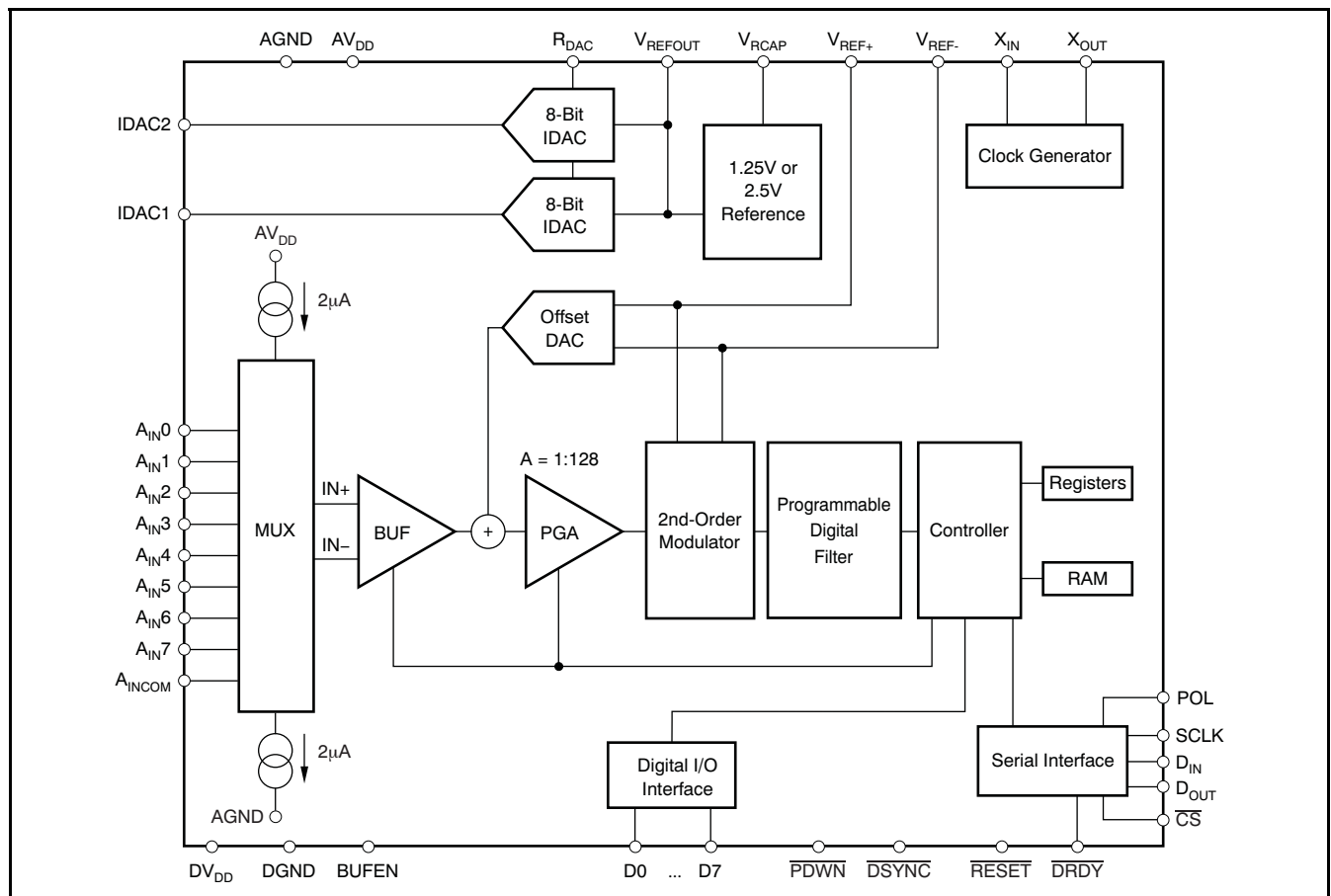

TIMING CHARACTERISTICS

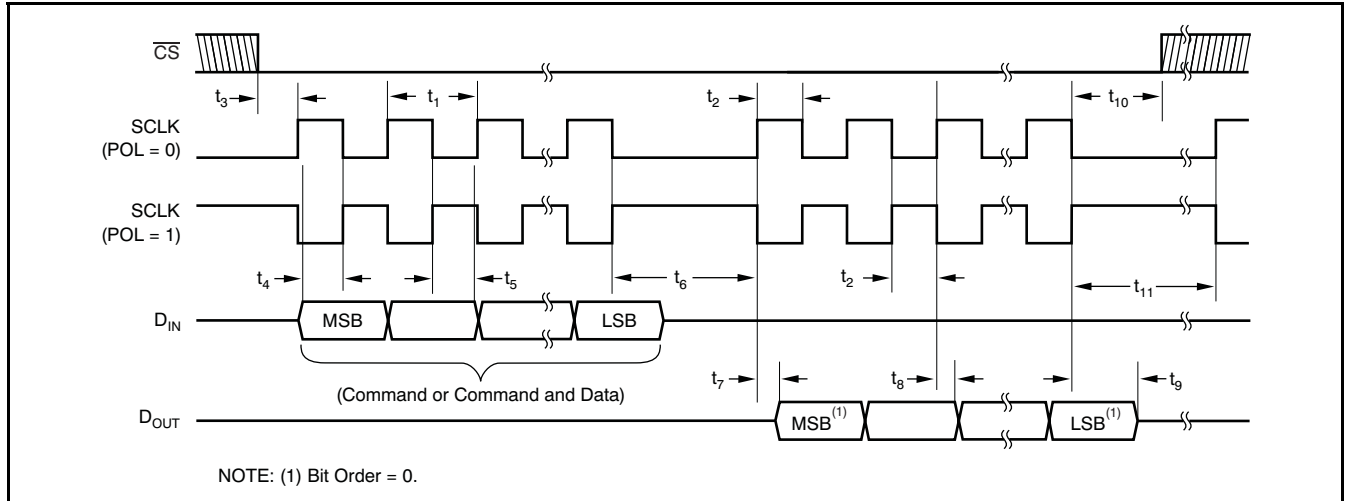

| SPEC | DESCRIPTION | MIN | MAX | UNITS |
|-----------------|---|------|-----|--------------------------|
| t ₁ | SCLK period | 4 | | t _{OSC} periods |
| | | | 3 | DRDY periods |
| t ₂ | SCLK pulse width, HIGH and LOW | 200 | | ns |
| t ₃ | \overline{CS} LOW to first SCLK edge; setup time | 0 | | ns |
| t ₄ | D _{IN} valid to SCLK edge; setup time | 50 | | ns |
| t ₅ | Valid D _{IN} to SCLK edge; hold time | 50 | | ns |
| t ₆ | Delay between last SCLK edge for D _{IN} and first SCLK edge for D _{OUT} : | | | |
| | RDATA, RDATA _C , RREG, WREG, RRAM, WRAM | 50 | | t _{OSC} periods |
| | CSREG, CSRAMX, CSRAM | 200 | | t _{OSC} periods |
| | CSARAM, CSARAMX | 1100 | | t _{OSC} periods |
| t ₇ | SCLK edge to valid new D _{OUT} | | 50 | ns |
| t ₈ | SCLK edge to D _{OUT} , hold time | 0 | | ns |
| t ₉ | Last SCLK edge to D _{OUT} tri-state NOTE: D _{OUT} goes tri-state immediately when \overline{CS} goes HIGH. | 6 | 10 | t _{OSC} periods |
| t ₁₀ | \overline{CS} LOW time after final SCLK edge | 16 | | t _{OSC} periods |
| t ₁₁ | Final SCLK edge of one op code until first edge SCLK of next command: | | | |
| | RREG, WREG, RRAM, WRAM, CSRAMX, CSARAM, CSARAM, CSREG, SLEEP, RDATA, RDATA _C , STOPC | 4 | | t _{OSC} periods |
| | CREG, CRAM | 220 | | t _{OSC} periods |
| | CREGA | 1600 | | t _{OSC} periods |
| | SELFGCAL, SELFOCAL, SYSOCAL, SYSGCAL | 7 | | DRDY periods |
| | SELCAL | 14 | | DRDY periods |
| | RESET (Command, SCLK or Pin), DSYNC | 16 | | t _{OSC} periods |

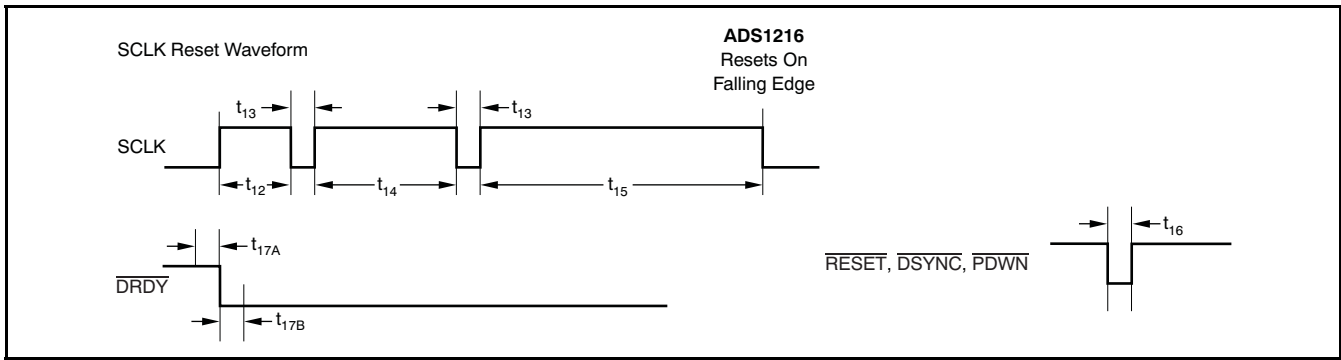

| SPEC | DESCRIPTION | MIN | MAX | UNITS |
|------------------|--|------|------|--------------------------|
| t ₁₂ | | 300 | 500 | t _{OSC} periods |
| t ₁₃ | | 5 | | t _{OSC} periods |
| t ₁₄ | | 550 | 750 | t _{OSC} periods |
| t ₁₅ | | 1050 | 1250 | t _{OSC} periods |
| t ₁₆ | Pulse width | 4 | | t _{OSC} periods |
| t _{17A} | DOR data not valid during this update period | 4 | | t _{OSC} periods |
| t _{17B} | DOR data not valid during this update period | 12 | | t _{OSC} periods |

DEVICE INFORMATION

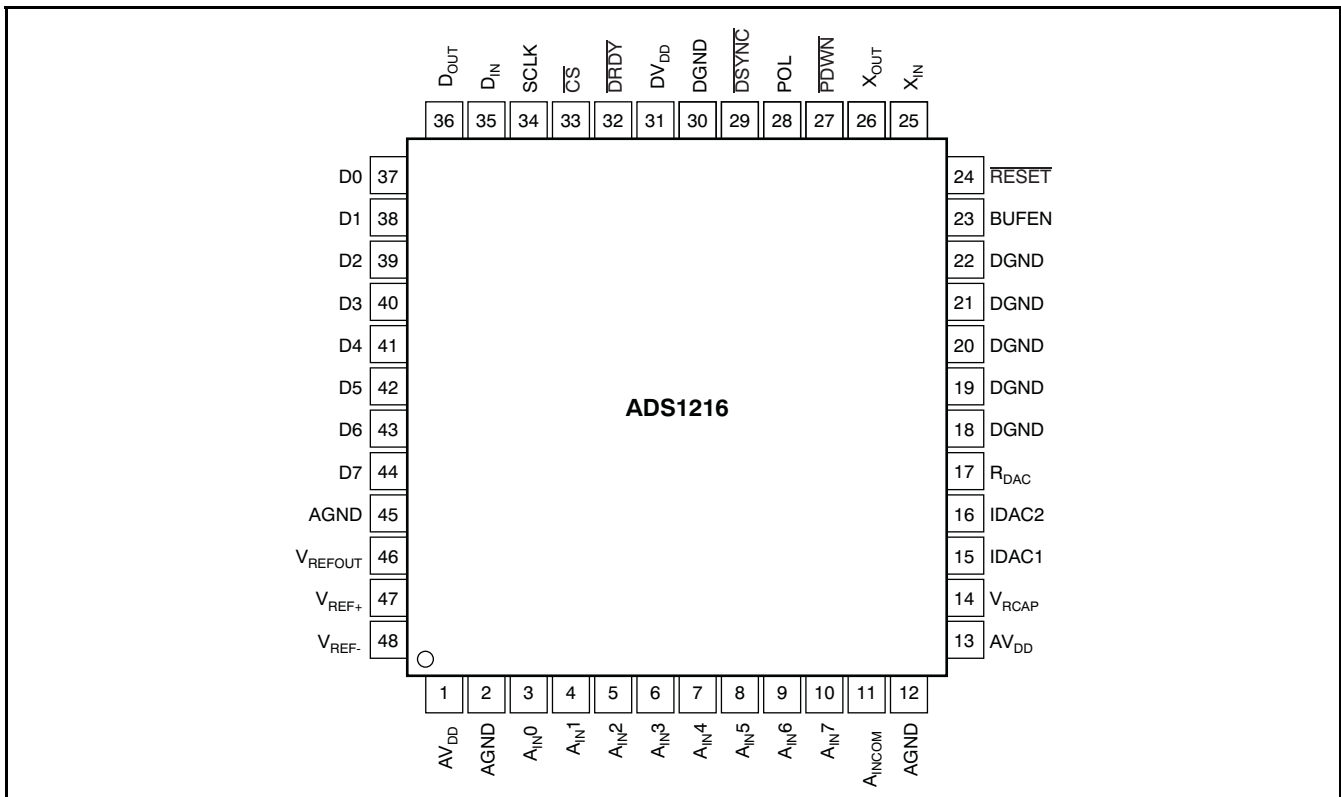

DEVICE INFORMATION (continued)
TERMINAL FUNCTIONS

| PIN NUMBER | NAME | DESCRIPTION |
|------------|--------------------|---|
| 1, 13 | $A_{V_{DD}}$ | Analog power supply |
| 2, 12, 45 | AGND | Analog ground |
| 3–10 | A_{IN0-7} | Analog input 0–7 |
| 11 | A_{INCOM} | Analog input common |
| 14 | V_{RCAP} | V_{REF} bypass capacitor |
| 15 | IDAC1 | Current DAC1 output |
| 16 | IDAC2 | Current DAC2 output |
| 17 | RDAC | Current DAC resistor |
| 18–22, 30 | DGND | Digital ground |
| 23 | BUFEN | Buffer enable |
| 24 | \overline{RESET} | Active LOW; resets the entire chip. |
| 25 | X_{IN} | Clock input |
| 26 | X_{OUT} | Clock output, used with crystal or resonator. |
| 27 | \overline{PDWN} | Active LOW; power down. The power-down function shuts down the analog and digital circuits. |
| 28 | POL | Serial clock polarity |
| 29 | \overline{DSYNC} | Active LOW; synchronization control |
| 31 | DV_{DD} | Digital power supply |
| 32 | \overline{DRDY} | Active LOW; data ready |
| 33 | \overline{CS} | Active LOW; chip select |
| 34 | SCLK | Serial clock, Schmitt trigger |
| 35 | D_{IN} | Serial data input, Schmitt trigger |
| 36 | D_{OUT} | Serial data output |
| 37–44 | D0–D7 | Digital I/O 0–7 |
| 46 | V_{REFOUT} | Voltage reference output |
| 47 | V_{REF+} | Positive differential reference input |
| 48 | V_{REF-} | Negative differential reference input |

TYPICAL CHARACTERISTICS

At $V_{DD} = +5V$, $DV_{DD} = +5V$, $f_{OSC} = 2.4576MHz$, $PGA = 1$, $R_{DAC} = 150k\Omega$, $f_{DATA} = 10Hz$, and $V_{REF} = +2.5V$, unless otherwise specified.

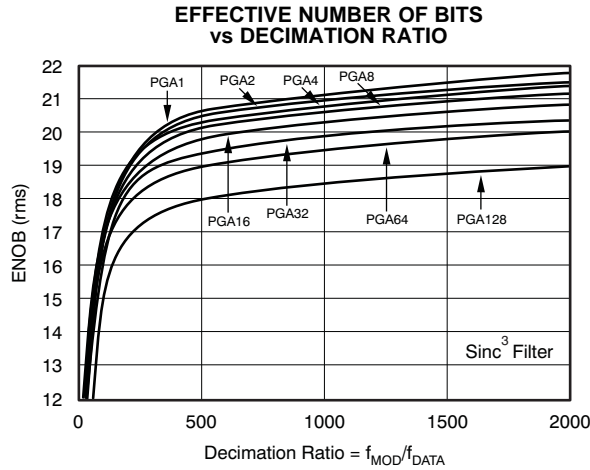

Figure 1.

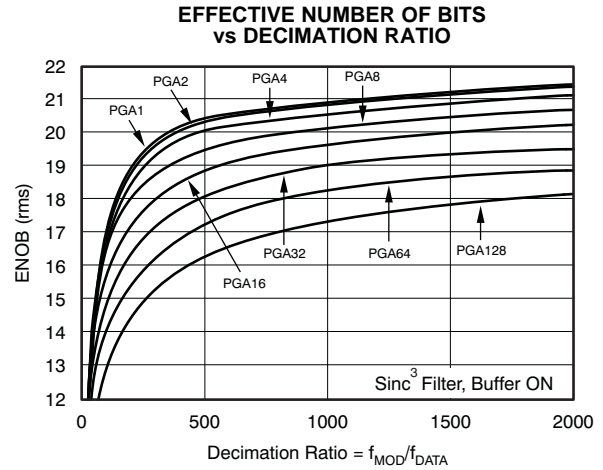

Figure 2.

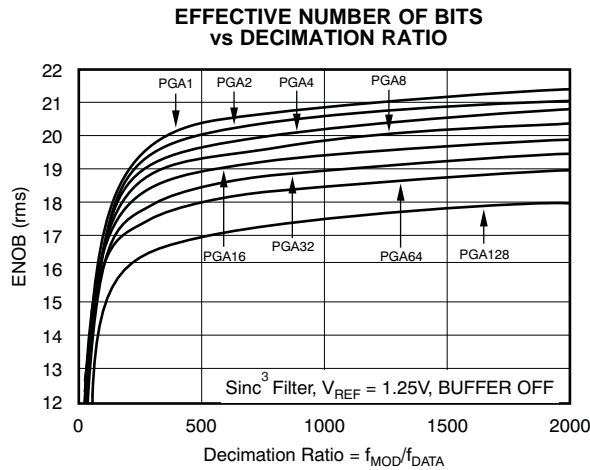

Figure 3.

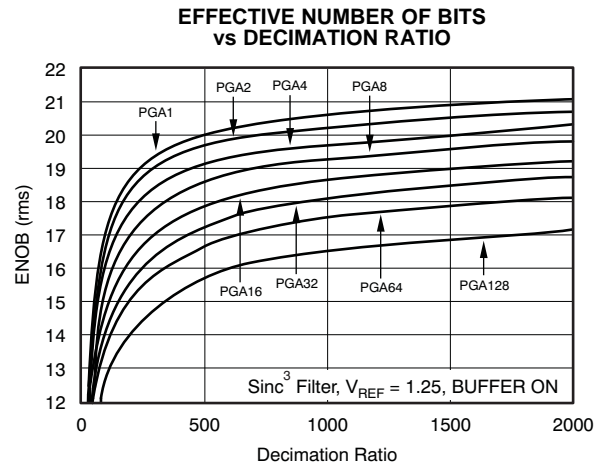

Figure 4.

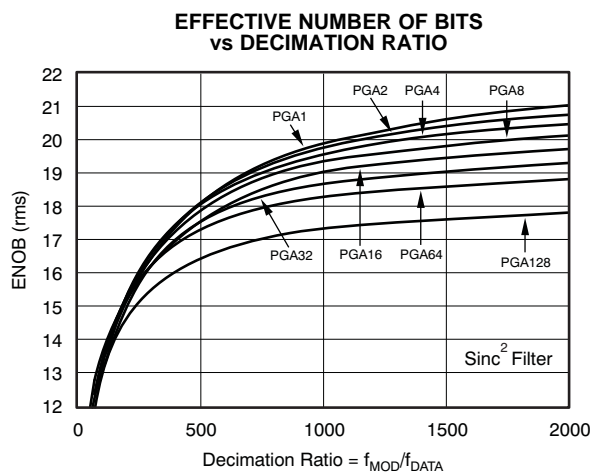

Figure 5.

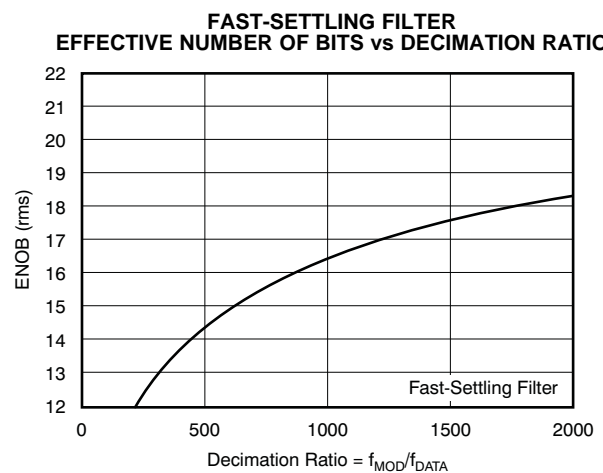

Figure 6.

TYPICAL CHARACTERISTICS (continued)

At $V_{DD} = +5V$, $DV_{DD} = +5V$, $f_{OSC} = 2.4576MHz$, $PGA = 1$, $R_{DAC} = 150k\Omega$, $f_{DATA} = 10Hz$, and $V_{REF} = +2.5V$, unless otherwise specified.

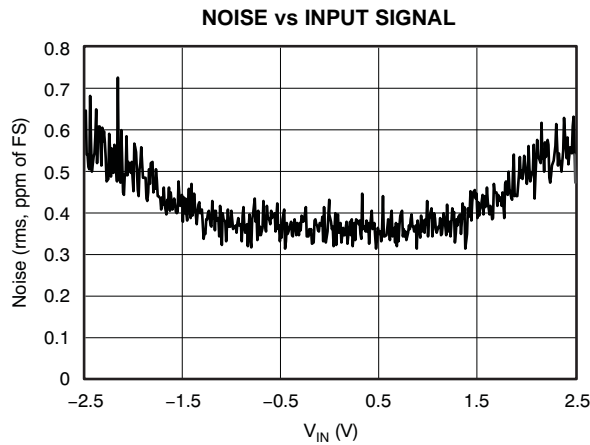

Figure 7.

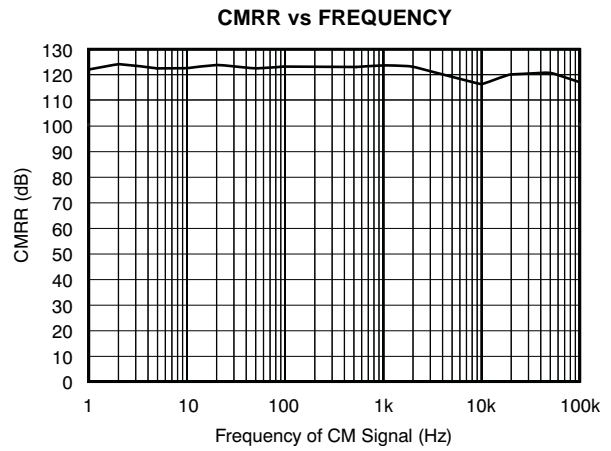

Figure 8.

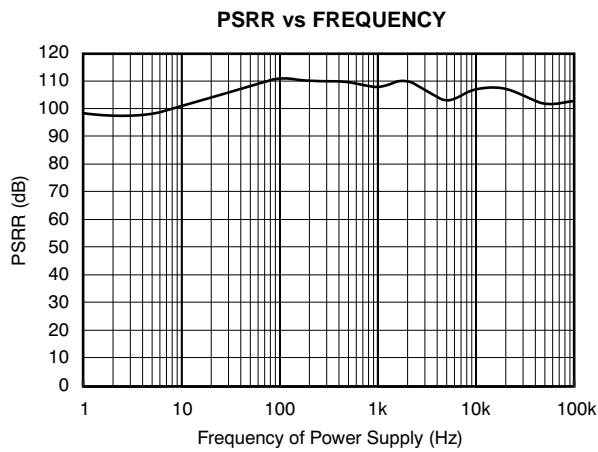

Figure 9.

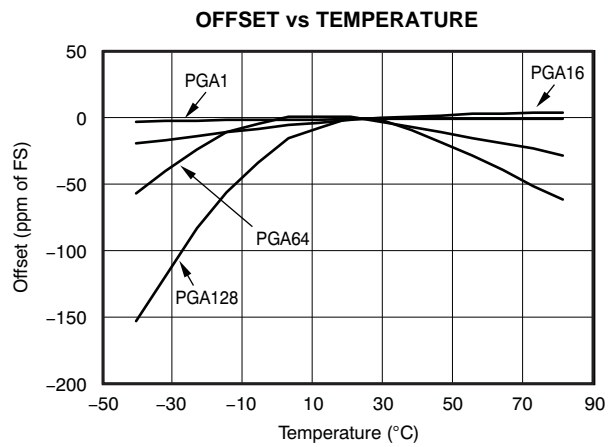

Figure 10.

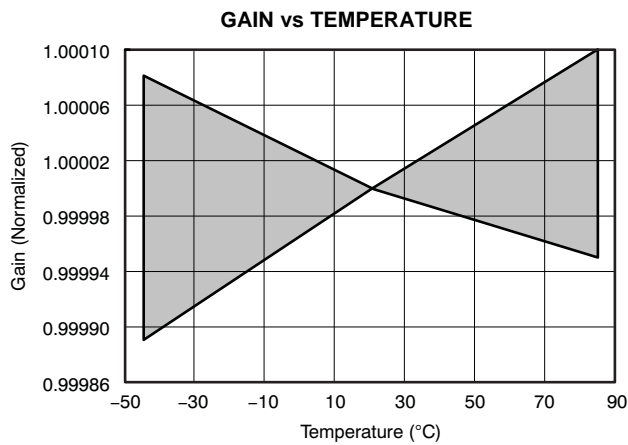

Figure 11.

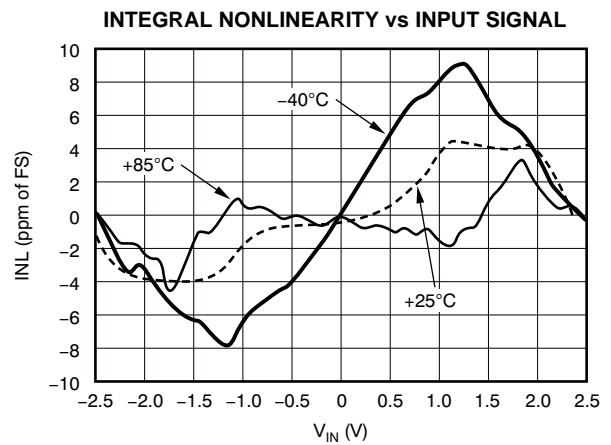

Figure 12.

TYPICAL CHARACTERISTICS (continued)

At $V_{DD} = +5V$, $DV_{DD} = +5V$, $f_{OSC} = 2.4576MHz$, $PGA = 1$, $R_{DAC} = 150k\Omega$, $f_{DATA} = 10Hz$, and $V_{REF} = +2.5V$, unless otherwise specified.

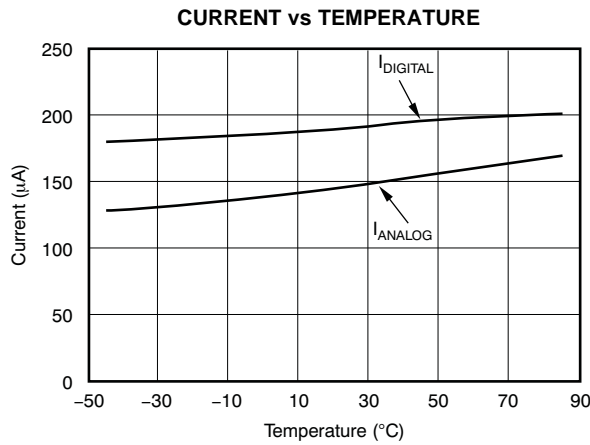

Figure 13.

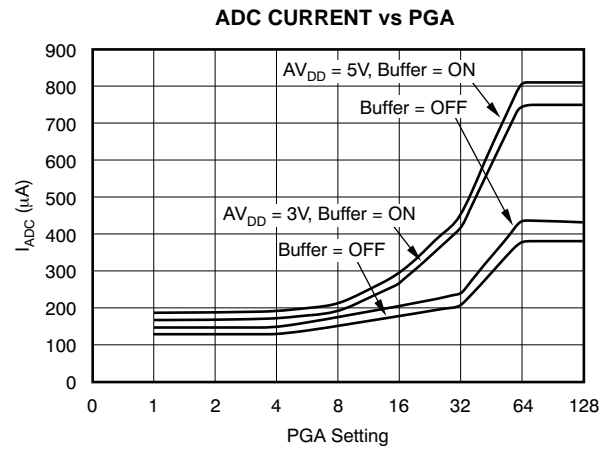

Figure 14.

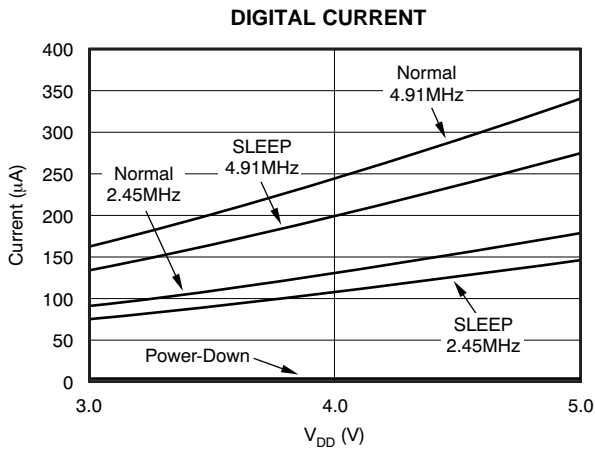

Figure 15.

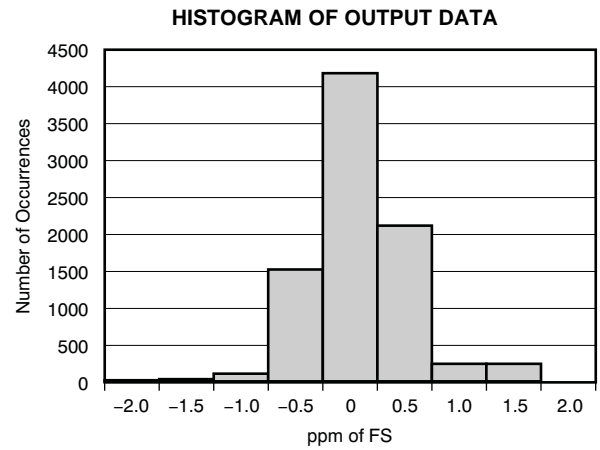

Figure 16.

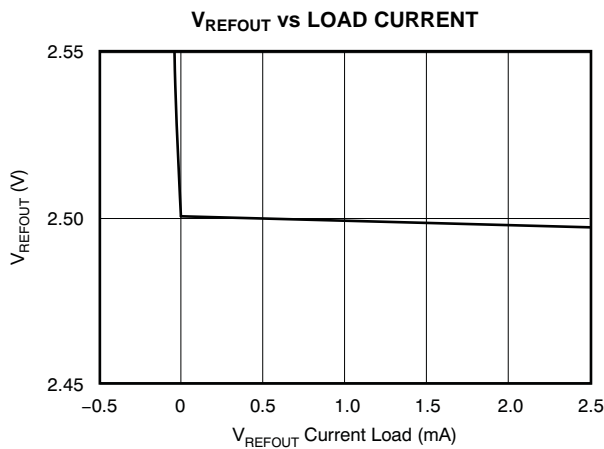

Figure 17.

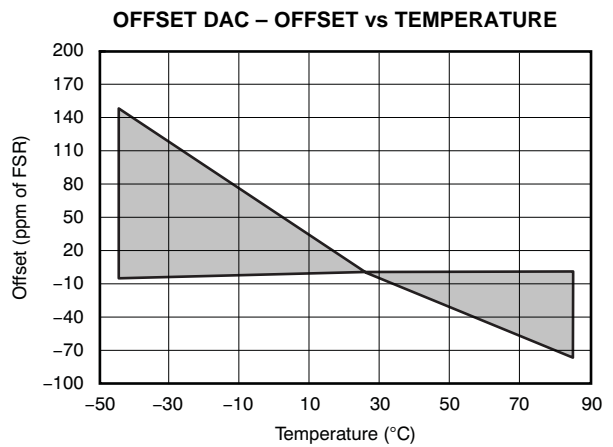

Figure 18.

TYPICAL CHARACTERISTICS (continued)

At $V_{DD} = +5V$, $DV_{DD} = +5V$, $f_{OSC} = 2.4576MHz$, $PGA = 1$, $R_{DAC} = 150k\Omega$, $f_{DATA} = 10Hz$, and $V_{REF} = +2.5V$, unless otherwise specified.

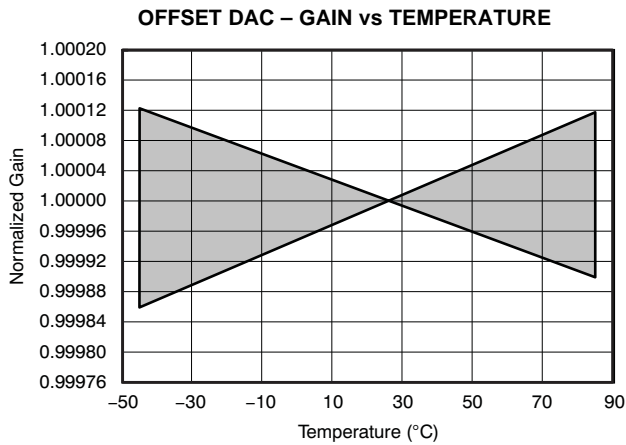

Figure 19.

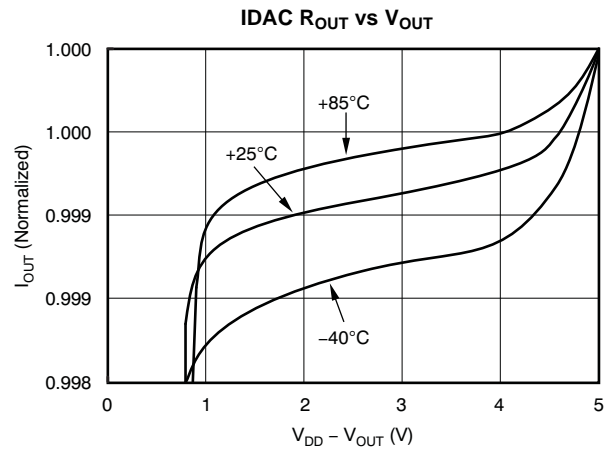

Figure 20.

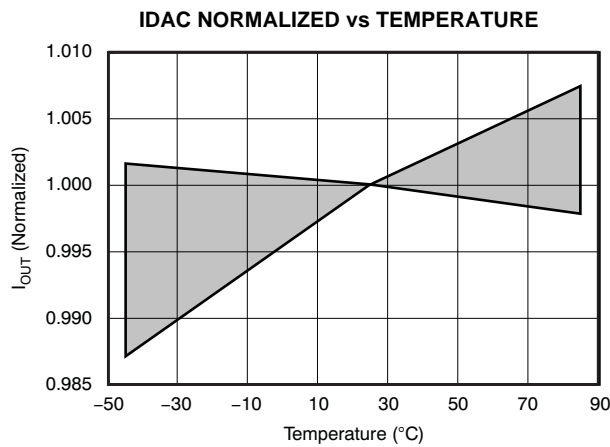

Figure 21.

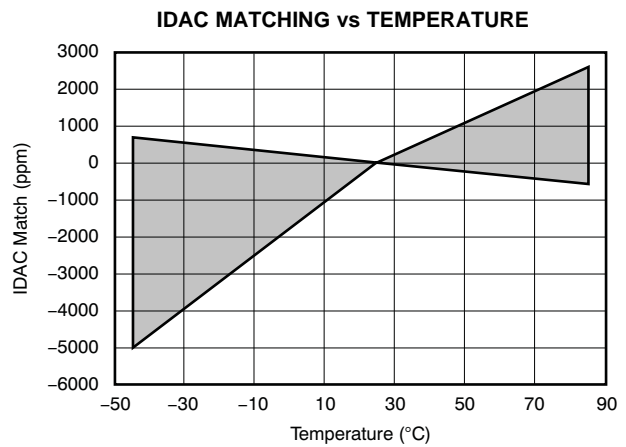

Figure 22.

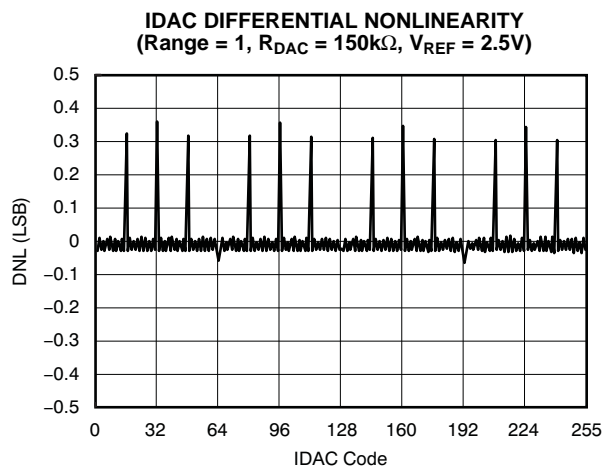

Figure 23.

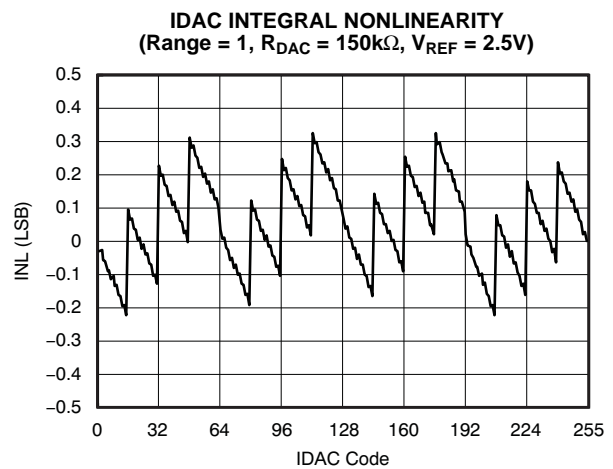

Figure 24.

OVERVIEW

INPUT MULTIPLEXER

The input multiplexer provides for any combination of differential inputs to be selected on any of the input channels, as shown in Figure 25. If channel 1 is selected as the positive differential input channel, any other channel can be selected as the negative differential input channel. With this method, it is possible to have up to eight fully-differential input channels.

In addition, current sources are supplied that will source or sink current to detect open or short circuits on the pins.

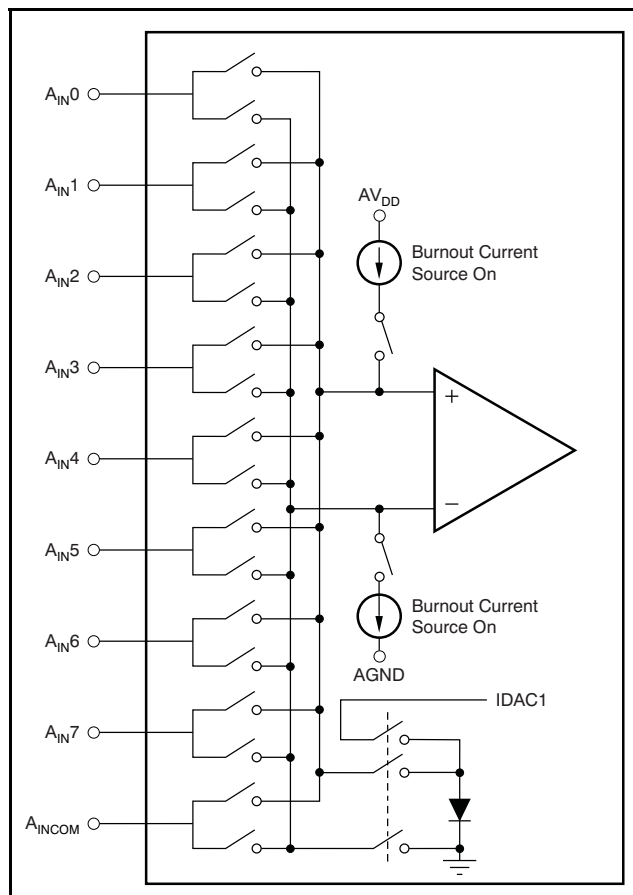

Figure 25. Input Multiplexer Configuration

TEMPERATURE SENSOR

An on-chip diode provides temperature sensing capability. When the configuration register for the input MUX is set to all 1s, the diode is connected to the input of the A/D converter. All other channels are open. The anode of the diode is connected to the positive input of the A/D converter, and the cathode

of the diode is connected to the negative input of the A/D converter. The output of IDAC1 is connected to the anode to bias the diode and the cathode of the diode is also connected to ground to complete the circuit.

In this mode, the output of IDAC1 is also connected to the output pin, so some current may flow into an external load from IDAC1, rather than the diode. See Application Report *Measuring Temperature with the ADS1216, ADS1217, or ADS1216 (SBAA073)*, available for download at www.ti.com, for more information.

BURNOUT CURRENT SOURCES

When the Burnout bit is set in the ACR Configuration Register (see the [Register Map](#) section), two current sources are enabled. The current source on the positive input channel sources approximately $2\mu\text{A}$ of current. The current source on the negative input channel sinks approximately $2\mu\text{A}$. This sinking allows for the detection of an open circuit (full-scale reading) or short circuit (0V differential reading) on the selected input differential pair.

INPUT BUFFER

The input impedance of the ADS1216 without the buffer is $5\text{M}\Omega/\text{PGA}$. With the buffer enabled, the input voltage range is reduced and the analog power-supply current is higher. The buffer is controlled by ANDing the state of the buffer pin with the state of the BUFFER bit in the ACR Register (see the [Register Map](#) section). See Application Report *Input Currents for High-Resolution ADCs (SBAA080)*, available for download at www.ti.com, for more information.

IDAC1 AND IDAC2

The ADS1216 has two 8-bit current output DACs that can be controlled independently. The output current is set with R_{DAC} , the range select bits in the ACR register, and the 8-bit digital value in the IDAC register. The output current equals $V_{\text{REF}}/(8 \times R_{\text{DAC}})(2^{\text{RANGE}} - 1)(\text{DAC CODE})$. With $V_{\text{REFOUT}} = 2.5\text{V}$ and $R_{\text{DAC}} = 150\text{k}\Omega$, the full-scale output can be selected to be 0.5, 1, or 2mA. The compliance voltage range is 0 to within 1V of AV_{DD} . When the internal voltage reference of the ADS1216 is used, it is the reference for the IDAC. An external reference may be used for the IDACs by disabling the internal reference and tying the external reference input to the V_{REFOUT} pin.

PROGRAMMABLE GAIN AMPLIFIER (PGA)

The PGA can be set to gains of 1, 2, 4, 8, 16, 32, 64, or 128. Using the PGA can improve the effective resolution of the A/D converter. For instance, with a PGA of 1 on a 5V full-scale range, the A/D converter can resolve to 1 μ V. With a PGA of 128 on a 40mV full-scale range, the A/D converter can resolve to 75nV.

PGA OFFSET DAC

The input to the PGA can be shifted by half the full-scale input range of the PGA by using the ODAC (Offset DAC) Register; see the Register Map section. The ODAC register is an 8-bit value; the MSB is the sign and the seven LSBs provide the magnitude of the offset. Using the ODAC does not reduce the performance of the A/D converter. See Application Report *The Offset DAC (SBAA077)*, available for download at www.ti.com, for more information.

MODULATOR

The modulator is a single-loop, second-order system. The modulator runs at a clock speed (f_{MOD}) that is derived from the external clock (f_{OSC}), as shown in Table 1. The frequency division is determined by the SPEED bit in the Setup Register (see the Register Map section).

Table 1. Modulator Speed

| SPEED BIT | f_{MOD} |
|-----------|---------------|
| 0 | $f_{OSC}/128$ |
| 1 | $f_{OSC}/256$ |

VOLTAGE REFERENCE INPUT

The ADS1216 uses a differential voltage reference input. The input signal is measured against the differential voltage $V_{REF} \equiv (V_{REF+}) - (V_{REF-})$. For $AV_{DD} = +5V$, V_{REF} is typically +2.5V. For $AV_{DD} = +3V$, V_{REF} is typically +1.25V. As a result of the sampling nature of the modulator, the reference input current increases with higher modulator clock frequency (f_{MOD}) and higher PGA settings.

ON-CHIP VOLTAGE REFERENCE

A selectable voltage reference (1.25V or 2.5V) is available for supplying the voltage reference input. To use, connect V_{REF-} to AGND and V_{REF+} to V_{REFOUT} . The enabling and voltage selection are controlled through bits REF EN and REF HI in the Setup Register (see the Register Map section). The 2.5V reference requires $AV_{DD} = +5V$. When using the on-chip voltage reference, the V_{REFOUT} pin should be bypassed with a 0.1 μ F capacitor to AGND.

V_{RCAP} PIN

This pin provides a bypass cap for noise filtering on internal V_{REF} circuitry only. This pin is a sensitive pin; therefore place the capacitor as close as possible and avoid any resistive loading. The recommended capacitor is a 1000pF ceramic cap. If an external V_{REF} is used, this pin can be left unconnected.

CLOCK GENERATOR

The clock source for the ADS1216 can be provided from a crystal, oscillator, or external clock. When the clock source is a crystal, external capacitors must be provided to ensure startup and a stable clock frequency; this configuration is shown in Figure 26 and Table 2.

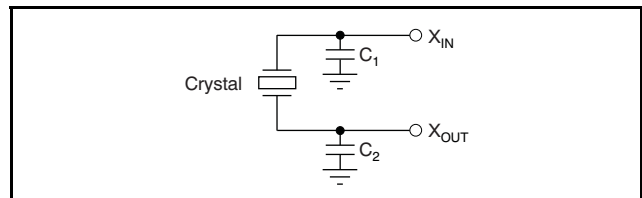

Figure 26. Crystal Connection

Table 2. Typical Clock Sources

| CLOCK SOURCE | FREQUENCY | C ₁ | C ₂ | PART NUMBER |
|--------------|-----------|----------------|----------------|---------------------|
| Crystal | 2.4576 | 0–20pF | 0–20pF | ECS, ECSD 2.45 – 32 |
| Crystal | 4.9152 | 0–20pF | 0–20pF | ECS, ECSD 4.91 |
| Crystal | 4.9152 | 0–20pF | 0–20pF | ECS, ECSD 4.91 |
| Crystal | 4.9152 | 0–20pF | 0–20pF | CTS, MP 042 4M9182 |

CALIBRATION

The offset and gain errors in the ADS1216, or the complete system, can be reduced with calibration. Internal calibration of the ADS1216 is called self-calibration. Self-calibration is handled with three commands. One command does both offset and gain calibration. There is also a gain calibration command and an offset calibration command. Each calibration process takes seven t_{DATA} periods to complete. It takes 14 t_{DATA} periods to complete both an offset and gain calibration. Self-gain calibration is optimized for PGA gains less than 8. When using higher gains, system gain calibration is recommended.

For system calibration, the appropriate signal must be applied to the inputs. The system offset command requires a zero differential input signal. It then computes an offset that will nullify offset in the system. The system gain command requires a positive full-scale differential input signal. It then computes a value to nullify gain errors in the system. Each of these calibrations will take seven t_{DATA} periods to complete.

Calibration must be performed after power on, a change in decimation ratio, or a change of the PGA. For operation with a reference voltage greater than ($AV_{DD} - 1.5V$), the buffer must also be turned off during calibration.

At the completion of calibration, the \overline{DRDY} signal goes low, which indicates the calibration is finished and valid data is available. See Application Report *Calibration Routine and Register Value Generation for the ADS121x Series (SBAA099)*, available for download at www.ti.com, for more information.

DIGITAL FILTER

The Digital Filter can use either the Fast-Settling, Sinc², or Sinc³ filter, as shown in Figure 27. In addition, the Auto mode changes the sinc filter after the input channel or PGA is changed. When switching to a new channel, it will use the Fast-Settling filter for the next two conversions, the first of which should be discarded. It will then use the Sinc² followed by the Sinc³ filter. This architecture combines the low-noise advantage of the Sinc³ filter with the quick response of the Fast-Settling time filter. See Figure 28 for the frequency response of each filter.

When using the Fast-Settling filter, select a decimation value set by the DEC0 and M/DEC1 registers that is evenly divisible by four for the best gain accuracy. For example, choose 260 rather than 261.

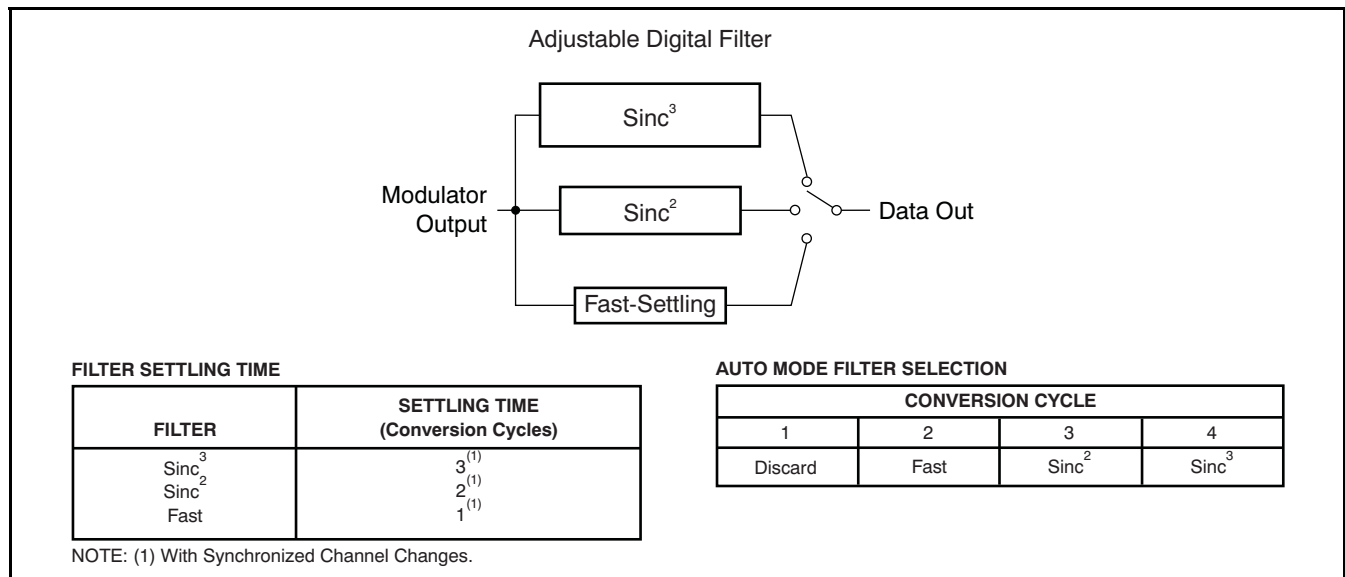

Figure 27. Filter Step Responses

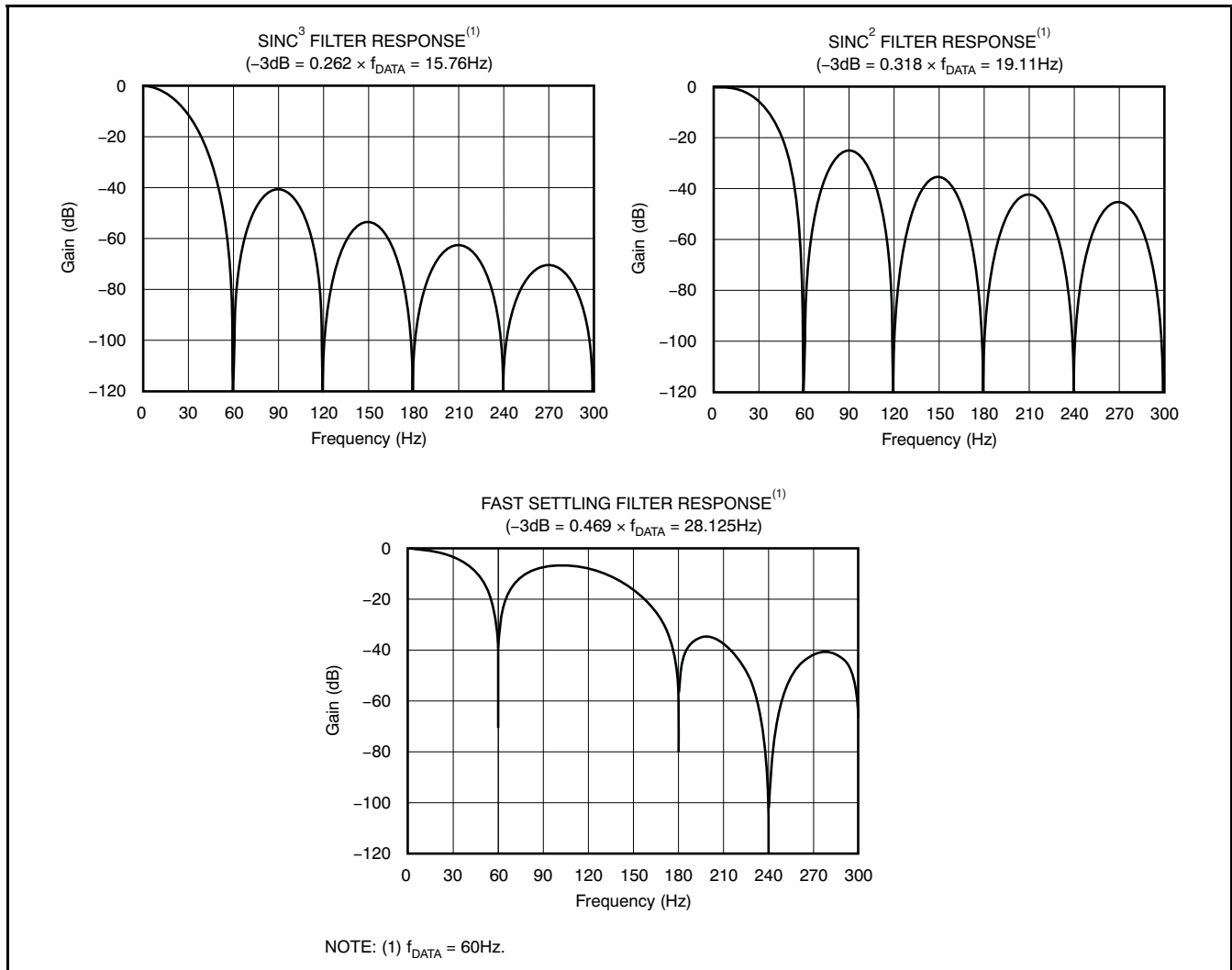

Figure 28. Filter Frequency Responses

DIGITAL I/O INTERFACE

The ADS1216 has eight pins dedicated for digital I/O. The default power-up condition for the digital I/O pins are as inputs. All of the digital I/O pins are individually configurable as inputs or outputs. They are configured through the DIR control register. The DIR register defines whether the pin is an input or output, and the DIO register defines the state of the digital output. When the digital I/O are configured as inputs, DIO is used to read the state of the pin. If the digital I/O are not used, either 1) configure as outputs; or 2) leave as inputs and tie to ground; this configuration prevents excess power dissipation.

SERIAL PERIPHERAL INTERFACE (SPI)

The SPI allows a controller to communicate synchronously with the ADS1216. The ADS1216 operates in slave-only mode.

Chip Select (\overline{CS})

The chip select (\overline{CS}) input of the ADS1216 must be externally asserted before a master device can exchange data with the ADS1216. \overline{CS} must be low for the duration of the transaction. \overline{CS} can be tied low.

Serial Clock (SCLK)

SCLK, a Schmitt-Trigger input, clocks data transfer on the D_{IN} input and D_{OUT} output. When transferring data to or from the ADS1216, multiple bits of data may be transferred back-to-back with no delay in SCLKs or toggling of \overline{CS} . Make sure to avoid glitches on SCLK because they can cause extra shifting of the data.

Polarity (POL)

The serial clock polarity is specified by the POL input. When SCLK is active high, set POL high. When SCLK is active low, set POL low.

DATA READY

The $\overline{\text{DRDY}}$ output is used as a status signal to indicate when data is ready to be read from the ADS1216. $\overline{\text{DRDY}}$ goes low when new data is available. It is reset high when a read operation from the data register is complete. It also goes high prior to the updating of the output register to indicate when not to read from the device to ensure that a data read is not attempted while the register is being updated.

DSYNC OPERATION

$\overline{\text{DSYNC}}$ is used to provide for synchronization of the A/D conversion with an external event. Synchronization can be achieved either through the $\overline{\text{DSYNC}}$ pin or the DSYNC command. When the $\overline{\text{DSYNC}}$ pin is used, the filter counter is reset on the falling edge of $\overline{\text{DSYNC}}$. The modulator is held in reset until $\overline{\text{DSYNC}}$ is taken high. Synchronization occurs on the next rising edge of the system clock after $\overline{\text{DSYNC}}$ is taken high.

MEMORY

Two types of memory are used on the ADS1216: registers and RAM. 16 registers directly control the various functions (PGA, DAC value, Decimation Ratio, etc.) and can be directly read or written to. Collectively, the registers contain all the information needed to configure the part, such as data format, mux settings, calibration settings, decimation ratio, etc. Additional registers, such as conversion data, are accessed through dedicated instructions.

REGISTER BANK

The operation of the device is set up through individual registers. The set of the 16 registers required to configure the device is referred to as a Register Bank, as shown in [Figure 29](#).

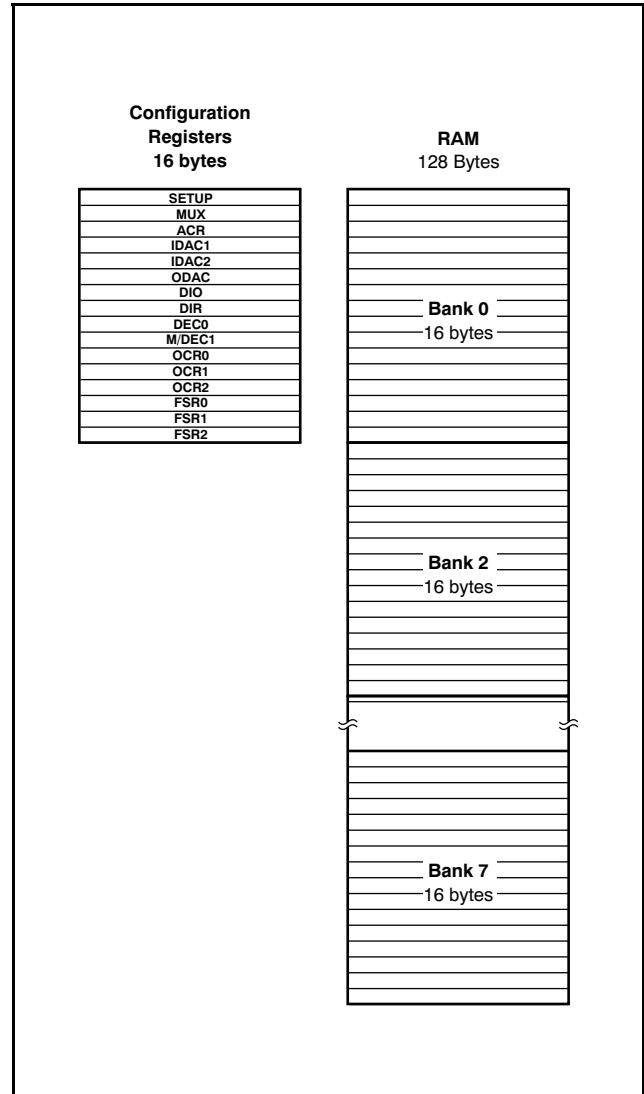

Figure 29. Memory Organization

RAM

Reads and Writes to Registers and RAM occur on a byte basis. However, copies between registers and RAM occur on a bank basis. The RAM is independent of the Registers; for example, the RAM can be used as general-purpose RAM.

The ADS1216 supports any combination of eight analog inputs. With this flexibility, the device can easily support eight unique configurations—one per input channel. In order to facilitate this type of usage, eight separate register banks are available. Therefore, each configuration could be written once and recalled as needed without having to serially retransmit all the configuration data. Checksum commands are also included, which can be used to verify the integrity of RAM.

The RAM provides eight *banks*, with a bank consisting of 16 bytes. The total size of the RAM is 128 bytes. Copies between the registers and RAM are performed on a bank basis. Also, the RAM can be directly read or written through the serial interface on power-up. The banks allow separate storage of settings for each input.

The RAM address space is linear; therefore, accessing RAM is done using an auto-incrementing pointer. Access to RAM in the entire memory map can be done consecutively without having to address each bank individually. For example, if you were currently accessing bank 0 at offset 0xF (the last location of bank 0), the next access would be bank 1 and offset 0x0. Any access after bank 7 and offset 0xF will wrap around to bank 0 and Offset 0x0.

Although the Register Bank memory is linear, the concept of addressing the device can also be thought of in terms of bank and offset addressing. Looking at linear and bank addressing syntax, we have the following comparison: in the linear memory map, the address 0x14 is equivalent to bank 1 and offset 0x4. Simply stated, the most significant four bits represent the bank, and the least significant four bits represent the offset. The offset is equivalent to the register address for that bank of memory.

REGISTER MAP

Table 3. Registers

| ADDRESS | REGISTER | BIT 7 | BIT 6 | BIT 5 | BIT 4 | BIT 3 | BIT 2 | BIT 1 | BIT 0 |
|---------|----------|---------|---------|---------|---------|----------|---------|---------|-----------|
| 00h | SETUP | ID | ID | ID | SPEED | REF EN | REF HI | BUF EN | BIT ORDER |
| 01h | MUX | PSEL3 | PSEL2 | PSEL1 | PSEL0 | NSEL3 | NSEL2 | NSEL1 | NSEL0 |
| 02h | ACR | BOCS | IDAC2R1 | IDAC2R0 | IDAC1R1 | IDAC1R0 | PGA2 | PGA1 | PGA0 |
| 03h | IDAC1 | IDAC1_7 | IDAC1_6 | IDAC1_5 | IDAC1_4 | IDAC1_3 | IDAC1_2 | IDAC1_1 | IDAC1_0 |
| 04h | IDAC2 | IDAC2_7 | IDAC2_6 | IDAC2_5 | IDAC2_4 | IDAC2_3 | IDAC2_2 | IDAC2_1 | IDAC2_0 |
| 05h | ODAC | SIGN | OSET_6 | OSET_5 | OSET_4 | OSET_3 | OSET_2 | OSET_1 | OSET_0 |
| 06h | DIO | DIO_7 | DIO_6 | DIO_5 | DIO_4 | DIO_3 | DIO_2 | DIO_1 | DIO_0 |
| 07h | DIR | DIR_7 | DIR_6 | DIR_5 | DIR_4 | DIR_3 | DIR_2 | DIR_1 | DIR_0 |
| 08h | DEC0 | DEC07 | DEC06 | DEC05 | DEC04 | DEC03 | DEC02 | DEC01 | DEC00 |
| 09h | M/DEC1 | DRDY | U/B | SMODE1 | SMODE0 | Reserved | DEC10 | DEC9 | DEC8 |
| 0Ah | OCR0 | OCR07 | OCR06 | OCR05 | OCR04 | OCR03 | OCR02 | OCR01 | OCR00 |
| 0Bh | OCR1 | OCR15 | OCR14 | OCR13 | OCR12 | OCR11 | OCR10 | OCR09 | OCR08 |
| 0Ch | OCR2 | OCR23 | OCR22 | OCR21 | OCR20 | OCR19 | OCR18 | OCR17 | OCR16 |
| 0Dh | FSR0 | FSR07 | FSR06 | FSR05 | FSR04 | FSR03 | FSR02 | FSR01 | FSR00 |
| 0Eh | FSR1 | FSR15 | FSR14 | FSR13 | FSR12 | FSR11 | FSR10 | FSR09 | FSR08 |
| 0Fh | FSR2 | FSR23 | FSR22 | FSR21 | FSR20 | FSR19 | FSR18 | FSR17 | FSR16 |

DETAILED REGISTER DEFINITIONS

SETUP (Address 00h) Setup Register

Reset value = iii01110.

| bit 7 | bit 6 | bit 5 | bit 4 | bit 3 | bit 2 | bit 1 | bit 0 |
|-------|-------|-------|-------|--------|--------|--------|-----------|
| ID | ID | ID | SPEED | REF EN | REF HI | BUF EN | BIT ORDER |

bits 7-5 Factory programmed bits

bit 4 SPEED: modulator clock speed

0 : $f_{MOD} = f_{OSC}/128$

1 : $f_{MOD} = f_{OSC}/256$

bit 3 REF EN: Internal voltage reference enable

0 = Internal voltage reference disabled

1 = Internal voltage reference enabled

bit 2 REF HI: internal reference voltage select

0 = Internal reference voltage = 1.25V

1 = Internal reference voltage = 2.5V

bit 1 BUF EN: buffer enable

0 = Buffer disabled

1 = Buffer enabled

bit 0 BIT ORDER: set order bits are transmitted

0 = Most significant bit transmitted first

1 = Least significant bit transmitted first data is always shifted into the part most significant bit first.

Data is always shifted out of the part most significant byte first. This configuration bit only controls the bit order within the byte of data that is shifted out.

MUX (Address 01h) Multiplexer Control Register

Reset value = 01h.

| bit 7 | bit 6 | bit 5 | bit 4 | bit 3 | bit 2 | bit 1 | bit 0 |
|-------|-------|-------|-------|-------|-------|-------|-------|
| PSEL3 | PSEL2 | PSEL1 | PSEL0 | NSEL3 | NSEL2 | NSEL1 | NSEL0 |

bits 7-4 PSEL3: PSEL2: PSEL1: PSEL0: Positive channel select

| | |
|---|-------------------------|
| 0000 = A _{IN0} | 0100 = A _{IN4} |
| 0001 = A _{IN1} | 0101 = A _{IN5} |
| 0010 = A _{IN2} | 0110 = A _{IN6} |
| 0011 = A _{IN3} | 0111 = A _{IN7} |
| 1xxx = A _{INCOM} (except when all bits are 1s) | |
| 1111 = Temperature sensor diode | |

bits 3-0 NSEL3: NSEL2: NSEL1: NSEL0: Negative channel select

| | |
|---|-------------------------|
| 0000 = A _{IN0} | 0100 = A _{IN4} |
| 0001 = A _{IN1} | 0101 = A _{IN5} |
| 0010 = A _{IN2} | 0110 = A _{IN6} |
| 0011 = A _{IN3} | 0111 = A _{IN7} |
| 1xxx = A _{INCOM} (except when all bits are 1s) | |
| 1111 = Temperature sensor diode | |

ACR (Address 02h) Analog Control Register

Reset value = 00h.

| bit 7 | bit 6 | bit 5 | bit 4 | bit 3 | bit 2 | bit 1 | bit 0 |
|-------|---------|---------|---------|---------|-------|-------|-------|
| BOCS | IDAC2R1 | IDAC2R0 | IDAC1R1 | IDAC1R0 | PGA2 | PGA1 | PGA0 |

bit 7 BOCS: Burnout current source
 0 = Disabled
 1 = Enabled

$$\text{IDAC Current} = \left(\frac{V_{\text{REF}}}{8R_{\text{DAC}}} \right) (2^{\text{RANGE}-1}) (\text{DAC CODE})$$

bits 6-5 IDAC2R1: IDAC2R0: Full-scale range select for IDAC2

00 = Off
 01 = Range 1
 10 = Range 2
 11 = Range 3

bits 4-3 IDAC1R1: IDAC1R0: Full-scale range select for IDAC1

00 = Off
 01 = Range 1
 10 = Range 2
 11 = Range 3

bits 2-0 PGA2: PGA1: PGA0: Programmable gain amplifier gain selection

| | |
|---------|-----------|
| 000 = 1 | 100 = 16 |
| 001 = 2 | 101 = 32 |
| 010 = 4 | 110 = 64 |
| 011 = 8 | 111 = 128 |

IDAC1 (Address 03h) Current DAC 1

Reset value = 00h.

| | | | | | | | |
|---------|---------|---------|---------|---------|---------|---------|---------|
| bit 7 | bit 6 | bit 5 | bit 4 | bit 3 | bit 2 | bit 1 | bit 0 |
| IDAC1_7 | IDAC1_6 | IDAC1_5 | IDAC1_4 | IDAC1_3 | IDAC1_2 | IDAC1_1 | IDAC1_0 |

The DAC code bits set the output of DAC1 from 0 to full-scale. The value of the full-scale current is set by this byte, V_{REF} , R_{DAC} , and the DAC1 range bits in the ACR register.

IDAC2 (Address 04h) Current DAC 2

Reset value = 00h.

| | | | | | | | |
|---------|---------|---------|---------|---------|---------|---------|---------|
| bit 7 | bit 6 | bit 5 | bit 4 | bit 3 | bit 2 | bit 1 | bit 0 |
| IDAC2_7 | IDAC2_6 | IDAC2_5 | IDAC2_4 | IDAC2_3 | IDAC2_2 | IDAC2_1 | IDAC2_0 |

The DAC code bits set the output of DAC2 from 0 to full-scale. The value of the full-scale current is set by this byte, V_{REF} , R_{DAC} , and the DAC2 range bits in the ACR register.

ODAC (Address 05h) Offset DAC Setting

Reset value = 00h.

| | | | | | | | |
|-------|-------|-------|-------|-------|-------|-------|-------|
| bit 7 | bit 6 | bit 5 | bit 4 | bit 3 | bit 2 | bit 1 | bit 0 |
| SIGN | OSET6 | OSET5 | OSET4 | OSET3 | OSET2 | OSET1 | OSET0 |

bit 7 Offset sign
 0 = Positive
 1 = Negative

bits 6-0
$$\text{Offset} = \frac{V_{REF}}{2PGA} \times \left(\frac{\text{Code}}{127} \right)$$

NOTE: The offset must be used after calibration or the calibration will nullify the effects.

DIO (Address 06h) Digital I/O

Reset value = 00h.

| | | | | | | | |
|-------|-------|-------|-------|-------|-------|-------|-------|
| bit 7 | bit 6 | bit 5 | bit 4 | bit 3 | bit 2 | bit 1 | bit 0 |
| DIO7 | DIO6 | DIO5 | DIO4 | DIO3 | DIO2 | DIO1 | DIO0 |

A value written to this register will appear on the digital I/O pins if the pin is configured as an output in the DIR register. Reading this register will return the value of the digital I/O pins.

DIR (Address 07h) Direction control for digital I/O

Reset value = FFh.

| | | | | | | | |
|-------|-------|-------|-------|-------|-------|-------|-------|
| bit 7 | bit 6 | bit 5 | bit 4 | bit 3 | bit 2 | bit 1 | bit 0 |
| DIR7 | DIR6 | DIR5 | DIR4 | DIR3 | DIR2 | DIR1 | DIR0 |

Each bit controls whether the Digital I/O pin is an output (= 0) or input (= 1). The default power-up state is as inputs.

DEC0 (Address 08h) Decimation Register (least significant 8 bits)

Reset value = 80h.

| | | | | | | | |
|-------|-------|-------|-------|-------|-------|-------|-------|
| bit 7 | bit 6 | bit 5 | bit 4 | bit 3 | bit 2 | bit 1 | bit 0 |
| DEC07 | DEC06 | DEC05 | DEC04 | DEC03 | DEC02 | DEC01 | DEC00 |

The decimation value is defined with 11 bits for a range of 20 to 2047. This register is the least significant eight bits. The three most significant bits are contained in the M/DEC1 register.

M/DEC1 (Address 09h) Mode and Decimation Register

Reset value = 07h.

| | | | | | | | |
|--------------------------|--------------------------|--------|--------|----------|-------|-------|-------|
| bit 7 | bit 6 | bit 5 | bit 4 | bit 3 | bit 2 | bit 1 | bit 0 |
| $\overline{\text{DRDY}}$ | U/ $\overline{\text{B}}$ | SMODE1 | SMODE0 | Reserved | DEC10 | DEC09 | DEC08 |

bit 7 $\overline{\text{DRDY}}$: Data ready (read-only)
This bit duplicates the state of the $\overline{\text{DRDY}}$ pin.

bit 6 U/ $\overline{\text{B}}$: Data format
0 = Bipolar
1 = Unipolar

| U/ $\overline{\text{B}}$ | ANALOG INPUT | DIGITAL OUTPUT |
|--------------------------|--------------------|------------------------------------|
| 0 | +FS Zero -FS | 0x7FFFFFFF 0x000000 0x800000 |
| 1 | +FS Zero -FS | 0xFFFFFFFF 0x000000 0x000000 |

bits 5-4 SMODE1: SMODE0: Settling mode

- 00 = Auto
- 01 = Fast-Settling filter
- 10 = Sinc² filter
- 11 = Sinc³ filter

bit 3 Reserved

This bit is not used in the ADS1216 and it is recommended that it be set to 0.

bits 2-0 DEC10: DEC09: DEC08: Most significant bits of the decimation value

OCR0 (Address 0Ah) Offset Calibration Coefficient (least significant byte)

Reset value = 00h.

| bit 7 | bit 6 | bit 5 | bit 4 | bit 3 | bit 2 | bit 1 | bit 0 |
|-------|-------|-------|-------|-------|-------|-------|-------|
| OCR07 | OCR06 | OCR05 | OCR04 | OCR03 | OCR02 | OCR01 | OCR00 |

OCR1 (Address 0Bh) Offset Calibration Coefficient (middle byte)

Reset value = 00h.

| bit 7 | bit 6 | bit 5 | bit 4 | bit 3 | bit 2 | bit 1 | bit 0 |
|-------|-------|-------|-------|-------|-------|-------|-------|
| OCR15 | OCR14 | OCR13 | OCR12 | OCR11 | OCR10 | OCR09 | OCR08 |

OCR2 (Address 0Ch) Offset Calibration Coefficient (most significant byte)

Reset value = 00h.

| bit 7 | bit 6 | bit 5 | bit 4 | bit 3 | bit 2 | bit 1 | bit 0 |
|-------|-------|-------|-------|-------|-------|-------|-------|
| OCR23 | OCR22 | OCR21 | OCR20 | OCR19 | OCR18 | OCR17 | OCR16 |

FSR0 (Address 0Dh) Full-Scale Register (least significant byte)

Reset value = 24h.

| bit 7 | bit 6 | bit 5 | bit 4 | bit 3 | bit 2 | bit 1 | bit 0 |
|-------|-------|-------|-------|-------|-------|-------|-------|
| FSR07 | FSR06 | FSR05 | FSR04 | FSR03 | FSR02 | FSR01 | FSR00 |

FSR1 (Address 0Eh) Full-Scale Register (middle byte)

Reset value = 90h.

| bit 7 | bit 6 | bit 5 | bit 4 | bit 3 | bit 2 | bit 1 | bit 0 |
|-------|-------|-------|-------|-------|-------|-------|-------|
| FSR15 | FSR14 | FSR13 | FSR12 | FSR11 | FSR10 | FSR09 | FSR08 |

FSR2 (Address 0Fh) Full-Scale Register (most significant byte)

Reset value = 67h.

| bit 7 | bit 6 | bit 5 | bit 4 | bit 3 | bit 2 | bit 1 | bit 0 |
|-------|-------|-------|-------|-------|-------|-------|-------|
| FSR23 | FSR22 | FSR21 | FSR20 | FSR19 | FSR18 | FSR17 | FSR16 |

COMMAND DEFINITIONS

The commands summarized in [Table 4](#) control the operation of the ADS1216. All of the commands are stand-alone except for the register reads and writes (RREG, WREG) which require a second command byte plus data. Additional command and data bytes may be shifted in without delay after the first command byte. The ORDER bit in the STATUS register (see the [Register map](#) section) sets the order of the bits within the output data. CS must stay low during the entire command sequence.

Table 4. Command Definitions⁽¹⁾

| COMMAND | DESCRIPTION | 1ST COMMAND BYTE | 2ND COMMAND BYTE |
|----------|--|------------------------|--|
| WAKEUP | Completes SYNC and exits standby mode | 0000 0000 (00h) | |
| RDATA | Read data | 0000 0001 (01h) | |
| RDATAC | Read data continuously | 0000 0011 (03h) | |
| SDATAC | Stop read data continuously | 0000 1111 (0Fh) | |
| RREG | Read from REG <i>rrr</i> | 0001 <i>rrrr</i> (1xh) | 0000 <i>nnnn</i> |
| RRAM | Read from RAM bank <i>aaa</i> | 0010 0aaa (2xh) | <i>xnnn nnnn</i> (number of bytes – 1) |
| CREG | Copy REG to RAM bank <i>aaa</i> | 0100 0aaa (4xh) | |
| CREGA | Copy REG to all RAM banks | 0100 1000 (48h) | |
| WREG | Write to REG <i>rrr</i> | 0101 <i>rrrr</i> (5xh) | 0000 <i>nnnn</i> |
| WRAM | Write to RAM bank <i>aaa</i> | 0110 0aaa (6xh) | <i>xnnn nnnn</i> (number of bytes – 1) |
| CRAM | Copy RAM bank <i>aaa</i> to REG | 1100 0aaa (Cxh) | |
| CSRAMX | Calculate RAM bank <i>aaa</i> checksum | 1101 0aaa (Dxh) | |
| CSARAMX | Calculate all RAM banks checksum | 1101 1000 (D8h) | |
| CSREG | Calculate REG checksum | 1101 1111 (DFh) | |
| CSRAM | Calculate RAM bank <i>aaa</i> checksum | 1110 0aaa (Exh) | |
| CSARAM | Calculate all RAM banks checksum | 1110 1000 (E8h) | |
| SELFAL | Offset and gain self-calibration | 1111 0000 (F0h) | |
| SELFOCAL | Offset self-calibration | 1111 0001 (F1h) | |
| SELFGCAL | Gain self-calibration | 1111 0010 (F2h) | |
| SYSOCAL | System offset calibration | 1111 0011 (F3h) | |
| SYSGCAL | System gain calibration | 1111 0100 (F4h) | |
| DSYNC | Synchronize the A/D conversion | 1111 1100 (FCh) | |
| SLEEP | Begin sleep mode | 1111 1101 (FDh) | |
| RESET | Reset to power-up values | 1111 1110 (FEh) | |
| WAKEUP | Completes SYNC and exits standby mode | 1111 1111 (FFh) | |

(1) n = number of registers to be read/written – 1. For example, to read/write three registers, set nnnn = 2 (0010). r = starting register address for read/write commands.

RDATA

Read Data

Description: Issue this command after $\overline{\text{DRDY}}$ goes low to read a single conversion result. After all 24 bits have been shifted out on D_{OUT} , $\overline{\text{DRDY}}$ goes high. It is not necessary to read back all 24 bits, but $\overline{\text{DRDY}}$ will then not return high until new data is being updated. See the [Timing Characteristics](#) for the required delay between the end of the RDATA command and the beginning of shifting data on D_{OUT} : t_6 .

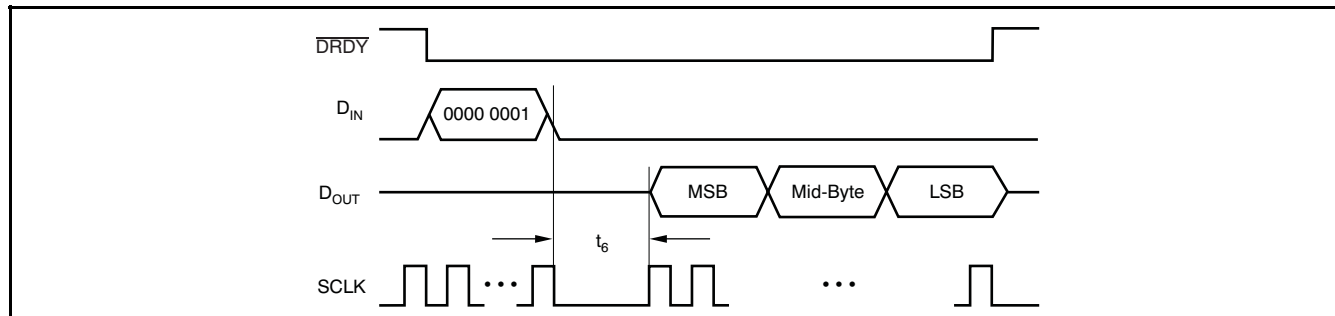

Figure 30. RDATA Command Sequence

RDATAC

Read Data Continuous

Description: Issue command after $\overline{\text{DRDY}}$ goes low to enter the Read Data Continuous mode. This mode enables the continuous output of new data on each $\overline{\text{DRDY}}$ without the need to issue subsequent read commands. After all 24 bits have been read, $\overline{\text{DRDY}}$ goes high. It is not necessary to read back all 24 bits, but $\overline{\text{DRDY}}$ will then not return high until new data is being updated. This mode may be terminated by the Stop Read Data Continuous command (STOPC). Because D_{IN} is constantly being monitored during the Read Data Continuous mode for the STOPC or RESET command, do not use this mode if D_{IN} and D_{OUT} are connected together. See the [Timing Characteristics](#) for the required delay between the end of the RDATAC command and the beginning of shifting data on D_{OUT} : t_6 .

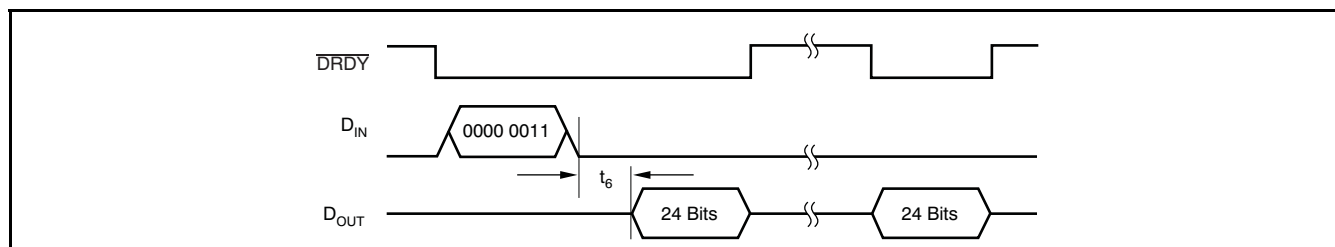

Figure 31. RDATAC Command Sequence

On the following $\overline{\text{DRDY}}$, shift out data by applying SCLKs. The Read Data Continuous mode terminates if input_data equals the STOPC or RESET command in any of the three bytes on D_{IN} .

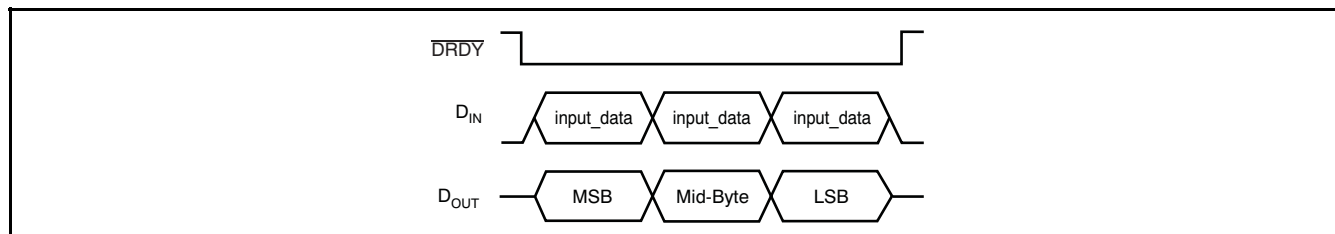

Figure 32. D_{IN} and D_{OUT} Command Sequence During Read Continuous mode

STOPC

Stop Read Data Continuous

Description: Ends the continuous data output mode; refer to RDATA_C in the [Command Definitions](#) section. The command must be issued after \overline{DRDY} goes low and completed before \overline{DRDY} goes high.

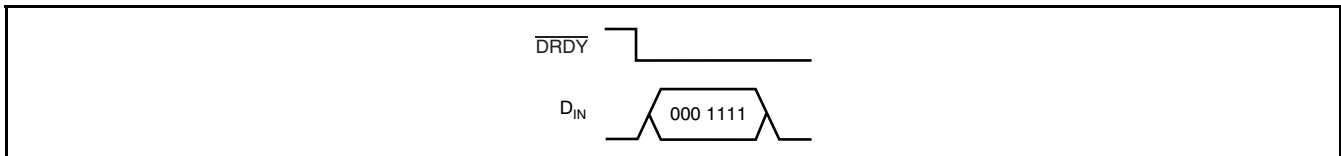

Figure 33. STOPC Command Sequence

RREG

Read from Registers

Description: Output the data from up to 16 registers starting with the register address specified as part of the command. The number of registers read will be one plus the second byte of the command. If the count exceeds the remaining registers, the addresses will wrap back to the beginning.

1st Command Byte: 0001 *rrrr* where *rrrr* is the address of the first register to read.

2nd Command Byte: 0000 *nnnn* where *nnnn* is the number of bytes to read – 1. See the [Timing Characteristics](#) for the required delay between the end of the RREG command and the beginning of shifting data on D_{OUT} : t_6 .

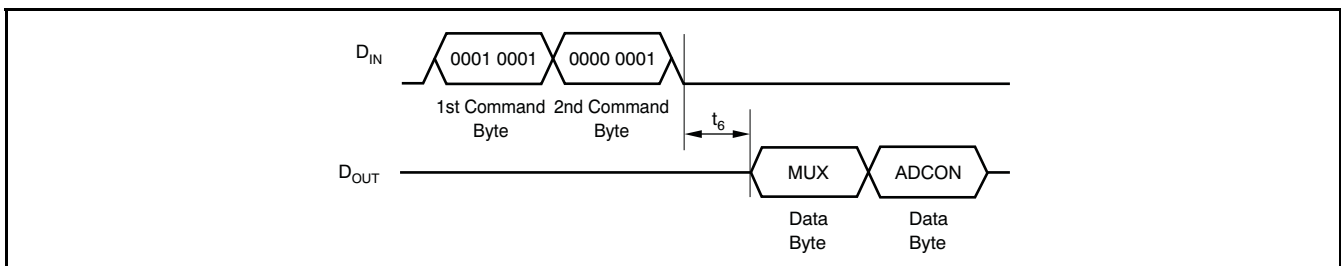

Figure 34. RREG Command Example: Read Two Registers Starting from Register 01h (multiplexer)

RRAM

Read from RAM

Description: This command allows for the direct reading of the RAM contents. All reads begin at the specified starting RAM bank. More than one bank can be read out in a single read operation. The reads will wrap around to the first bank if there is more data to be retrieved when the last bank is completely read. See the [Timing Characteristics](#) for the required delay between the end of the RRAM command and the beginning of shifting data on D_{OUT} : t_6 .

1st Command Byte: 0010 0aaa where *aaa* is the starting RAM bank for the read.

2nd Command Byte: 0nnn nnnn where *nnn nnnn* is the number of bytes to be read – 1.

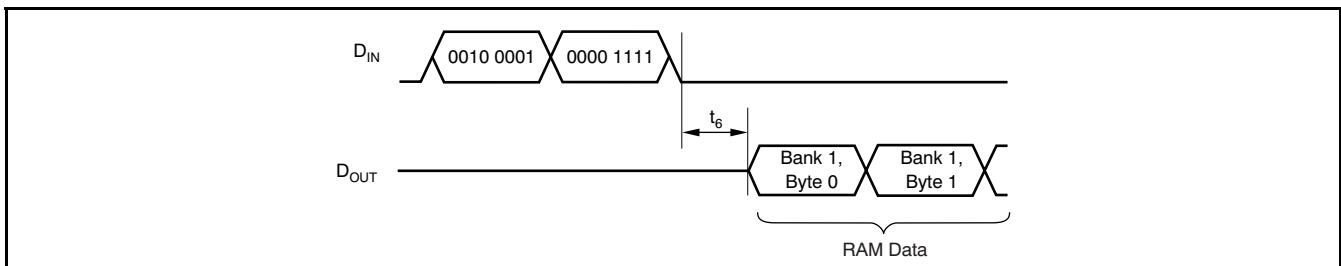

Figure 35. RRAM Command Example: Read 16 Bytes Starting from Bank 1

CREG

Copy Registers to RAM Bank

Description: This command copies the registers to the selected RAM bank. Do not issue additional commands while the copy operation is underway.

1st Command byte: 0100 0aaa where *aaa* is the RAM bank that will be updated with a copy of the registers.

CREGA

Copy Registers to All RAM Banks

Description: This command copies the registers to all RAM banks. Do not issue additional commands while the copy operation is underway.

WREG

Write to Register

Description: Write to the registers starting with the register specified as part of the command. The number of registers that will be written is one plus the value of the second byte in the command.

1st Command Byte: 0101 *rrrr* where *rrrr* is the address to the first register to be written.

2nd Command Byte: 0000 *nnnn* where *nnnn* is the number of bytes to be written – 1.

Data Byte(s): data to be written to the registers.

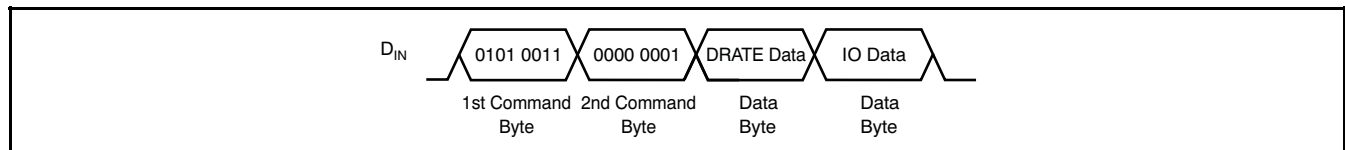

Figure 36. WREG Command Example: Write Two Registers Starting from 03h (DRATE)

WRAM

Write to RAM

Description: This command allows for direct writing to the RAM. All writes begin at the specified starting RAM bank. More than one bank can be written in a single write operation. The writes will wrap around to the first bank if there is more data to be written when the last bank is completely written. See the [Timing Characteristics](#) for the required delay between the end of the RRAM command and the beginning of shifting data on D_{OUT} : t_6 .

1st Command Byte: 0010 0aaa where *aaa* is the starting RAM bank for the write.

2nd Command Byte: 0nnn *nnnn* where *nnn nnnn* is the number of bytes to be written – 1.

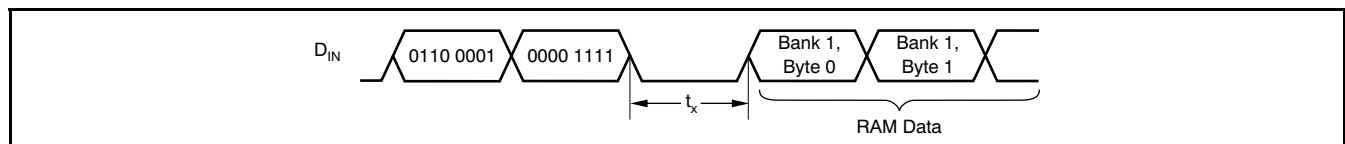

Figure 37. WRAM Command Example: Write 16 Bytes Starting at Bank 1

CRAM

Copy Selected RAM Bank to Registers

Description: This command copies the selected RAM bank to the registers. This action will overwrite all previous register settings. Do not issue additional commands while this copy operation is underway.

1st Command Byte: 1100 0aaa where *aaa* is the selected RAM bank.

CSRAM

Calculate Checksum for Selected RAM Bank

Description: This command calculates the checksum for the selected RAM bank. The checksum is calculated as the sum of all the bytes in the registers with the carry ignored. Do not issue any additional commands while the checksum is being calculated.

CSRAMX

Calculate Checksum for Selected RAM Bank, Ignoring Certain Bits

Description: This command calculates the checksum of the selected RAM bank. The checksum is calculated as a sum of all the bytes in the RAM bank with the carry ignored. The ID, $\overline{\text{DRDY}}$, and DIO bits are masked and are not included in the checksum calculation. Do not issue any additional commands while the checksum is being calculated.

CSARAM

Calculate Checksum for all RAM Banks

Description: This command calculates the checksum for all RAM banks. The checksum is calculated as a sum of all the bytes in the RAM bank with the carry ignored. Do not issue any additional commands while the checksum is being calculated.

CSARAMX

Calculate Checksum for all RAM Banks, Ignoring Certain Bits

Description: This command calculates the checksum for all RAM banks. The checksum is calculated as a sum of all the bytes in the RAM bank with the carry ignored. The ID, $\overline{\text{DRDY}}$, and DIO bits are masked and are not included in the checksum calculation. Do not issue any additional commands while the checksum is being calculated.

CSREG

Calculate Checksum for the Registers

Description: This command calculates the checksum for the registers. The checksum is calculated as a sum of all the bytes in the registers with the carry ignored. The ID, $\overline{\text{DRDY}}$, and DIO bits are masked and are not included in the checksum calculation. Do not issue any additional commands while the checksum is being calculated.

See the [Timing Characteristics](#) for the required delay between the end of the checksum commands and the beginning of shifting data on D_{OUT} : t_6 . Note that this time is dependent on the specific checksum command used.

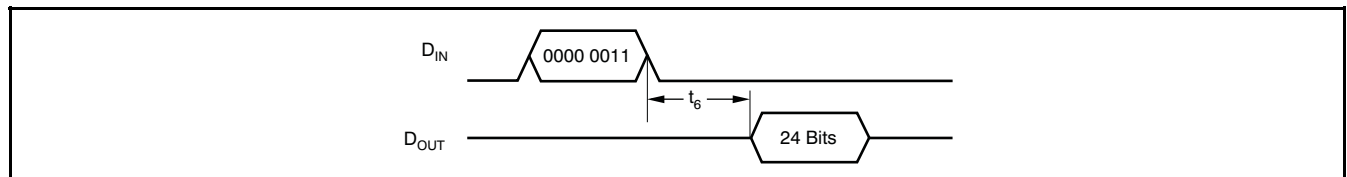

Figure 38. Checksum Command Sequence

SYSOCAL

System Offset Calibration

Description: Performs a system offset calibration. The Offset Calibration Register (OFC) is updated after this operation. $\overline{\text{DRDY}}$ goes high at the beginning of the calibration. It goes low after the calibration completes and settled data is ready. Do not send additional commands after issuing this command until $\overline{\text{DRDY}}$ goes low indicating that the calibration is complete.

SYSGCAL

System Gain Calibration

Description: Performs a system gain calibration. The Full-Scale Calibration Register (FSC) is updated after this operation. $\overline{\text{DRDY}}$ goes high at the beginning of the calibration. It goes low after the calibration completes and settled data is ready. Do not send additional commands after issuing this command until $\overline{\text{DRDY}}$ goes low indicating that the calibration is complete.

DSYNC

Synchronize the A/D Conversion

Description: This command synchronizes the A/D conversion. To use, first shift in the command. Then shift in the WAKEUP command. Synchronization occurs on the first CLKIN rising edge after the first SCLK used to shift in the WAKEUP command.

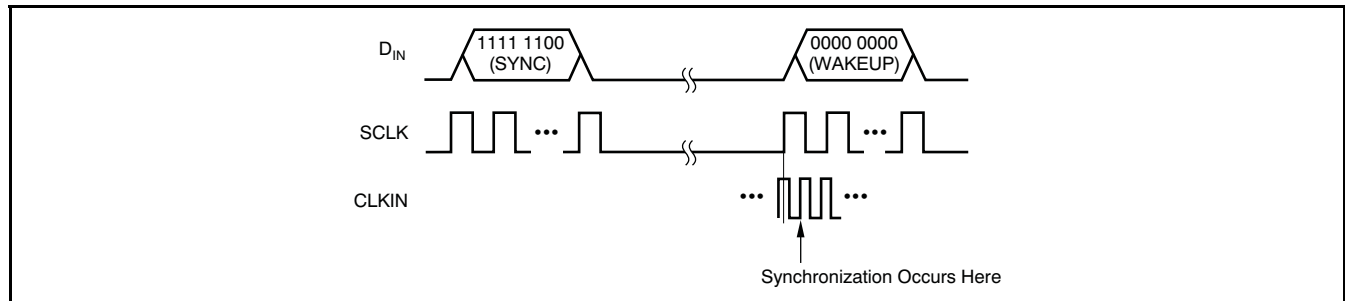

Figure 39. DSYNC Command Sequence

SLEEP

Sleep Mode

Description: This command puts the ADS1216 into a Sleep mode. After issuing the SLEEP command, make sure there is no more activity on SCLK while $\overline{\text{CS}}$ is low because this will interrupt Sleep mode. If $\overline{\text{CS}}$ is high, SCLK activity is allowed during Sleep mode. To exit Sleep mode, issue the WAKEUP command.

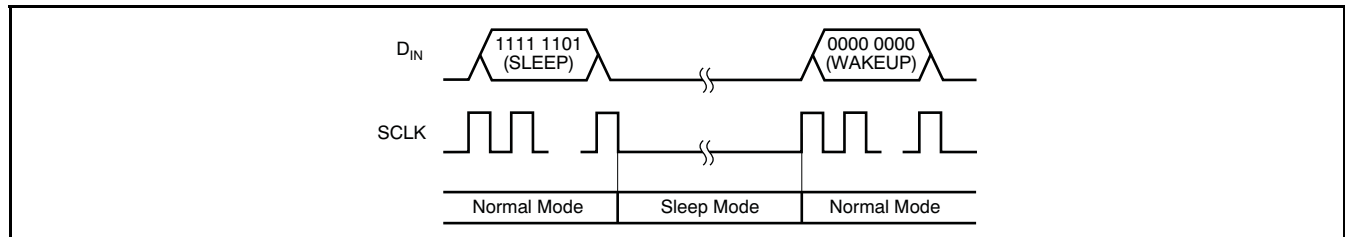

Figure 40. SLEEP Command Sequence

WAKEUP

Complete Synchronization or Exit Sleep Mode

Description: Used in conjunction with the SYNC and STANDBY commands. Two values (all zeros or all ones) are available for this command.

RESET

Reset Registers to Default Values

Description: Returns all registers to their default values. This command will also stop the Read Data Continuous mode. While in the Read Data Continuous mode, the RESET command must be issued after $\overline{\text{DRDY}}$ goes low and complete before $\overline{\text{DRDY}}$ returns high.

DEFINITIONS

Analog Input Voltage—the voltage at any one analog input relative to AGND.

Analog Input Differential Voltage—given by the following equation: $(A_{IN+}) - (A_{IN-})$. Thus, a positive digital output is produced whenever the analog input differential voltage is positive, while a negative digital output is produced whenever the differential is negative.

For example, when the converter is configured with a 2.5V reference and placed in a gain setting of 1, the positive full-scale output is produced when the analog input differential is 2.5V. The negative full-scale output is produced when the differential is -2.5V. In each case, the actual input voltages must remain within the AGND to AV_{DD} range.

Conversion Cycle—the term *conversion cycle* usually refers to a discrete A/D conversion operation, such as that performed by a successive approximation converter. As used here, a conversion cycle refers to the t_{DATA} time period. However, each digital output is actually based on the modulator results from several t_{DATA} time periods.

| FILTER SETTING | MODULATOR RESULTS |
|-------------------|--------------------------|
| Fast Settling | 1 t_{DATA} Time Period |
| Sinc ² | 2 t_{DATA} Time Period |
| Sinc ³ | 3 t_{DATA} Time Period |

Data Rate—the rate at which conversions are completed. See definition for f_{DATA} .

Decimation Ratio—defines the ratio between the output of the modulator and the output Data Rate. Valid values for the Decimation Ratio are from 20 to 2047. Larger Decimation Ratios will have lower noise.

Effective Resolution—the effective resolution of the ADS1216 in a particular configuration can be expressed in two different units: bits rms (referenced to output) and V_{RMS} (referenced to input). Computed directly from the converter output data, each is a statistical calculation. The conversion from one to the other is shown below.

Effective number of bits (ENOB) or effective resolution is commonly used to define the usable resolution of the A/D converter. It is calculated from empirical data taken directly from the device. It is typically determined by applying a fixed known signal source to the analog input and computing the standard deviation of the data sample set. The rms noise defines the $\pm\sigma$ interval about the sample mean.

The data from the A/D converter is output as codes, which then can be easily converted to other units, such as ppm or volts. The equations and table below show the relationship between bits or codes, ppm, and volts.

$$ENOB = \frac{-20 \log(\text{ppm})}{6.02}$$

| BITS rms | BIPOLAR V_{RMS} | UNIPOLAR V_{RMS} |
|----------|---|--|
| | $\frac{\left(\frac{2V_{REF}}{PGA}\right)}{10^{\left(\frac{6.02ER}{20}\right)}}$ | $\frac{\left(\frac{V_{REF}}{PGA}\right)}{10^{\left(\frac{6.02ER}{20}\right)}}$ |
| 24 | 298nV | 149nV |
| 22 | 1.19µV | 597nV |
| 20 | 4.77µV | 2.39µV |
| 18 | 19.1µV | 9.55µV |
| 16 | 76.4µV | 38.2µV |
| 14 | 505µV | 152.7µV |
| 12 | 1.22mV | 610µV |

f_{DATA} —the frequency of the digital output data produced by the ADS1216. f_{DATA} is also referred to as the data rate.

$$f_{DATA} = \left(\frac{f_{MOD}}{\text{Decimation Ratio}}\right) = \left(\frac{f_{OSC}}{\text{mfactor Decimation Ratio}}\right)$$

f_{MOD} —the frequency or speed at which the modulator of the ADS1216 is running. This rate depends on the SPEED bit as shown below:

| SPEED BIT | f_{MOD} |
|-----------|---------------|
| 0 | $f_{OSC}/128$ |
| 1 | $f_{OSC}/256$ |

f_{OSC} —the frequency of the crystal input signal at the X_{IN} input of the ADS1216.

f_{SAMP} —the frequency, or switching speed, of the input sampling capacitor. The value is given by one of the following equations:

| PGA SETTING | SAMPLING FREQUENCY |
|-------------|---|
| 1, 2, 4, 8 | $f_{SAMP} = \frac{f_{OSC}}{\text{mfactor}}$ |
| 8 | $f_{SAMP} = \frac{2f_{OSC}}{\text{mfactor}}$ |
| 16 | $f_{SAMP} = \frac{8f_{OSC}}{\text{mfactor}}$ |
| 32 | $f_{SAMP} = \frac{16f_{OSC}}{\text{mfactor}}$ |
| 64, 128 | $f_{SAMP} = \frac{16f_{OSC}}{\text{mfactor}}$ |

Filter Selection—the ADS1216 uses a (sinx/x) filter or sinc filter. There are three different sinc filters that can be selected. A Fast-Settling filter will settle in one t_{DATA} cycle. The Sinc² filter will settle in two cycles and have lower noise. The Sinc³ will achieve lowest noise and higher number of effective bits, but requires three cycles to settle. The ADS1216 will operate with any one of these filters, or it can operate in an auto mode, where it will first select the Fast-Settling filter after a new channel is selected for two readings and will then switch to Sinc² for one reading, followed by Sinc³ from then on.

Full-Scale Range (FSR)—as with most A/D converters, the full-scale range of the ADS1216 is defined as the *input*, which produces the positive full-scale digital output minus the *input*, which produces the negative full-scale digital output. The full-scale range changes with gain setting; see [Table 5](#).

For example, when the converter is configured with a 2.5V reference and is placed in a gain setting of 2, the full-scale range is: [1.25V (positive full-scale) – (–1.25V (negative full-scale))] = 2.5V.

Least Significant Bit (LSB) Weight—this is the theoretical amount of voltage that the differential voltage at the analog input would have to change in order to observe a change in the output data of one least significant bit. It is computed as shown in [Equation 1](#):

$$\text{LSB Weight} = \frac{\text{Full-Scale Range}}{2^N} \quad (1)$$

where N is the number of bits in the digital output.

t_{DATA} —the inverse of f_{DATA} , or the period between each data output.

Table 5. Full-Scale Range vs PGA Setting

| GAIN SETTING | 5V SUPPLY ANALOG INPUT ⁽¹⁾ | | | GENERAL EQUATIONS | | |
|--------------|---------------------------------------|--|------------------|------------------------|--|----------------------------|
| | FULL-SCALE RANGE | DIFFERENTIAL INPUT VOLTAGES ⁽²⁾ | PGA OFFSET RANGE | FULL-SCALE RANGE | DIFFERENTIAL INPUT VOLTAGES ⁽²⁾ | PGA SHIFT RANGE |
| 1 | 5V | ±2.5V | ±1.25V | $\frac{2V_{REF}}{PGA}$ | $\pm \frac{V_{REF}}{PGA}$ | $\pm \frac{V_{REF}}{2PGA}$ |
| 2 | 2.5V | ±1.25V | ±0.625V | | | |
| 4 | 1.25V | ±0.625V | ±312.5mV | | | |
| 8 | 0.625V | ±312.5mV | ±156.25mV | | | |
| 16 | 312.5mV | ±156.25mV | ±78.125mV | | | |
| 34 | 156.25mV | ±78.125mV | ±39.0625mV | | | |
| 64 | 78.125mV | ±39.0625mV | ±19.531mV | | | |
| 128 | 39.0625mV | ±19.531mV | ±9.766mV | | | |

(1) With a 2.5V reference.

(2) The ADS1216 allows common-mode voltage as long as the absolute input voltage on A_{IN+} or A_{IN-} does not go below AGND or above AV_{DD} .

| Changes from C Revision (May 2006) to D Revision | Page |
|---|------|
| • Added title for Table 1 | 16 |
| • Changed <i>11 registers</i> to <i>16 registers</i> in Description text of RREG section in Command Definitions. | 28 |

PACKAGING INFORMATION

| Orderable Device | Status ⁽¹⁾ | Package Type | Package Drawing | Pins | Package Qty | Eco Plan ⁽²⁾ | Lead/Ball Finish | MSL Peak Temp ⁽³⁾ |
|------------------|-----------------------|--------------|-----------------|------|-------------|-------------------------|------------------|------------------------------|
| ADS1216Y/250 | ACTIVE | TQFP | PFB | 48 | 250 | Green (RoHS & no Sb/Br) | CU NIPDAU | Level-2-260C-1 YEAR |
| ADS1216Y/250G4 | ACTIVE | TQFP | PFB | 48 | 250 | Green (RoHS & no Sb/Br) | CU NIPDAU | Level-2-260C-1 YEAR |
| ADS1216Y/2K | ACTIVE | TQFP | PFB | 48 | 2000 | Green (RoHS & no Sb/Br) | CU NIPDAU | Level-2-260C-1 YEAR |
| ADS1216Y/2KG4 | ACTIVE | TQFP | PFB | 48 | 2000 | Green (RoHS & no Sb/Br) | CU NIPDAU | Level-2-260C-1 YEAR |

⁽¹⁾ The marketing status values are defined as follows:

ACTIVE: Product device recommended for new designs.

LIFEBUY: TI has announced that the device will be discontinued, and a lifetime-buy period is in effect.

NRND: Not recommended for new designs. Device is in production to support existing customers, but TI does not recommend using this part in a new design.

PREVIEW: Device has been announced but is not in production. Samples may or may not be available.

OBSOLETE: TI has discontinued the production of the device.

⁽²⁾ Eco Plan - The planned eco-friendly classification: Pb-Free (RoHS), Pb-Free (RoHS Exempt), or Green (RoHS & no Sb/Br) - please check <http://www.ti.com/productcontent> for the latest availability information and additional product content details.

TBD: The Pb-Free/Green conversion plan has not been defined.

Pb-Free (RoHS): TI's terms "Lead-Free" or "Pb-Free" mean semiconductor products that are compatible with the current RoHS requirements for all 6 substances, including the requirement that lead not exceed 0.1% by weight in homogeneous materials. Where designed to be soldered at high temperatures, TI Pb-Free products are suitable for use in specified lead-free processes.

Pb-Free (RoHS Exempt): This component has a RoHS exemption for either 1) lead-based flip-chip solder bumps used between the die and package, or 2) lead-based die adhesive used between the die and leadframe. The component is otherwise considered Pb-Free (RoHS compatible) as defined above.

Green (RoHS & no Sb/Br): TI defines "Green" to mean Pb-Free (RoHS compatible), and free of Bromine (Br) and Antimony (Sb) based flame retardants (Br or Sb do not exceed 0.1% by weight in homogeneous material)

⁽³⁾ MSL, Peak Temp. -- The Moisture Sensitivity Level rating according to the JEDEC industry standard classifications, and peak solder temperature.

Important Information and Disclaimer:The information provided on this page represents TI's knowledge and belief as of the date that it is provided. TI bases its knowledge and belief on information provided by third parties, and makes no representation or warranty as to the accuracy of such information. Efforts are underway to better integrate information from third parties. TI has taken and continues to take reasonable steps to provide representative and accurate information but may not have conducted destructive testing or chemical analysis on incoming materials and chemicals. TI and TI suppliers consider certain information to be proprietary, and thus CAS numbers and other limited information may not be available for release.

In no event shall TI's liability arising out of such information exceed the total purchase price of the TI part(s) at issue in this document sold by TI to Customer on an annual basis.

TAPE AND REEL INFORMATION

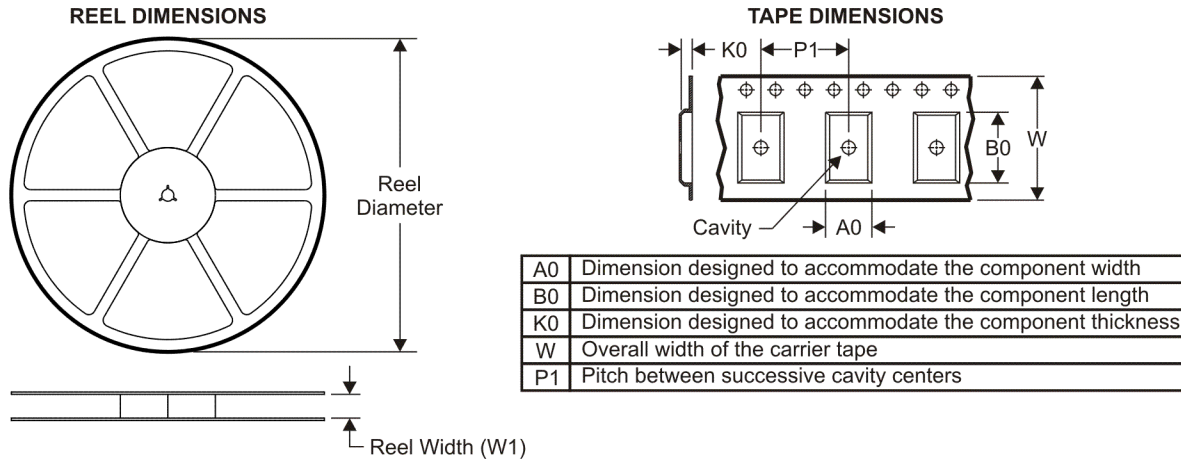

QUADRANT ASSIGNMENTS FOR PIN 1 ORIENTATION IN TAPE



*All dimensions are nominal

| Device | Package Type | Package Drawing | Pins | SPQ | Reel Diameter (mm) | Reel Width W1 (mm) | A0 (mm) | B0 (mm) | K0 (mm) | P1 (mm) | W (mm) | Pin1 Quadrant |
|--------------|--------------|-----------------|------|------|--------------------|--------------------|---------|---------|---------|---------|--------|---------------|
| ADS1216Y/250 | TQFP | PFB | 48 | 250 | 177.8 | 16.4 | 9.6 | 9.6 | 1.5 | 12.0 | 16.0 | Q2 |
| ADS1216Y/2K | TQFP | PFB | 48 | 2000 | 330.0 | 16.8 | 9.6 | 9.6 | 1.5 | 12.0 | 16.0 | Q2 |

TAPE AND REEL BOX DIMENSIONS



*All dimensions are nominal

| Device | Package Type | Package Drawing | Pins | SPQ | Length (mm) | Width (mm) | Height (mm) |
|--------------|--------------|-----------------|------|------|-------------|------------|-------------|
| ADS1216Y/250 | TQFP | PFB | 48 | 250 | 190.5 | 212.7 | 31.8 |
| ADS1216Y/2K | TQFP | PFB | 48 | 2000 | 346.0 | 346.0 | 33.0 |

PFB (S-PQFP-G48)

PLASTIC QUAD FLATPACK

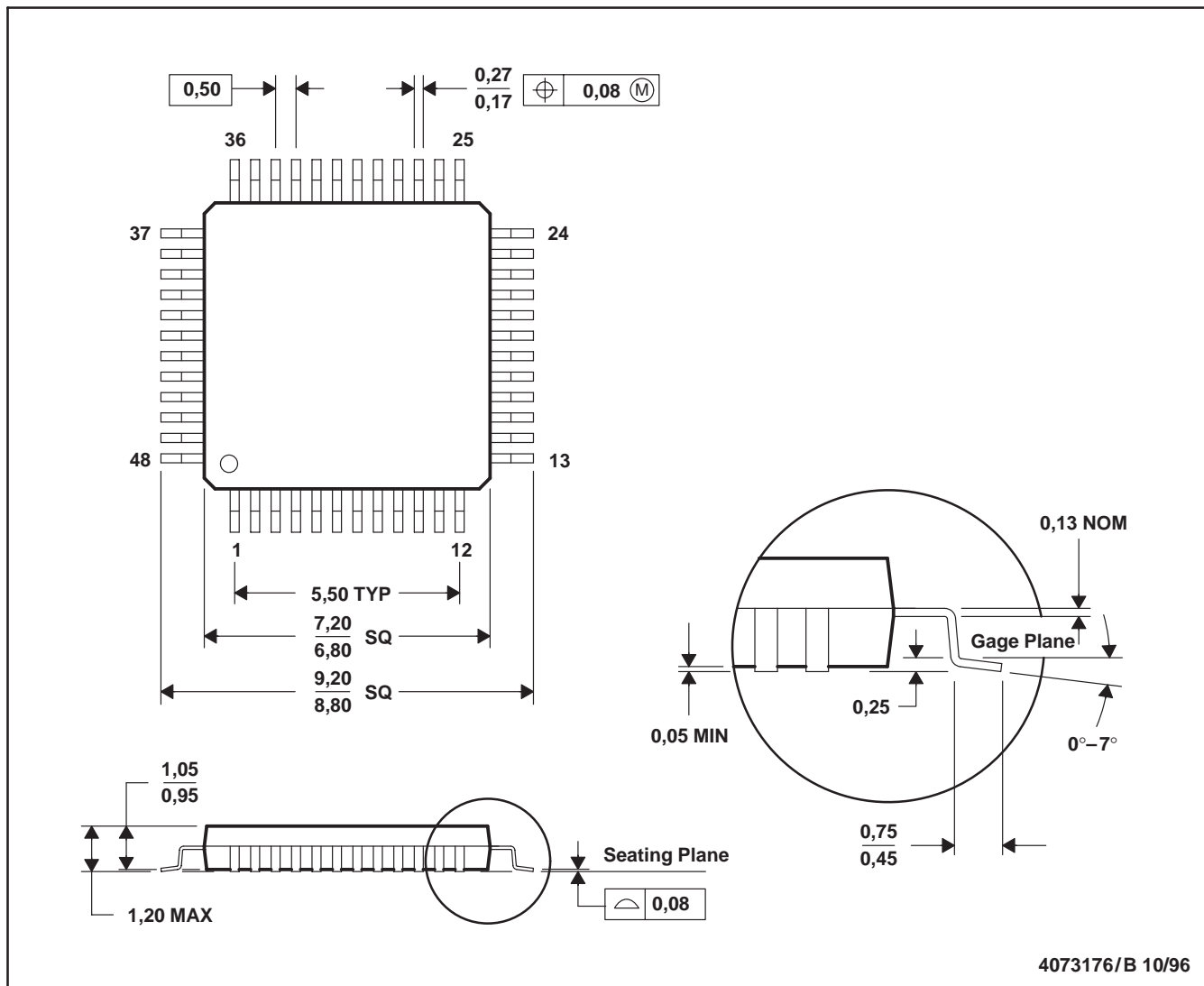

- NOTES: A. All linear dimensions are in millimeters.
 B. This drawing is subject to change without notice.
 C. Falls within JEDEC MS-026

PFB (S-PQFP-G48)



- NOTES:
- A. All linear dimensions are in millimeters.
 - B. This drawing is subject to change without notice.
 - C. Publication IPC-7351 is recommended for alternate designs.
 - D. Laser cutting apertures with trapezoidal walls and also rounding corners will offer better paste release. Customers should contact their board assembly site for stencil design recommendations. Refer to IPC-7525.
 - E. Customers should contact their board fabrication site for solder mask tolerances between and around signal pads.

IMPORTANT NOTICE

Texas Instruments Incorporated and its subsidiaries (TI) reserve the right to make corrections, modifications, enhancements, improvements, and other changes to its products and services at any time and to discontinue any product or service without notice. Customers should obtain the latest relevant information before placing orders and should verify that such information is current and complete. All products are sold subject to TI's terms and conditions of sale supplied at the time of order acknowledgment.

TI warrants performance of its hardware products to the specifications applicable at the time of sale in accordance with TI's standard warranty. Testing and other quality control techniques are used to the extent TI deems necessary to support this warranty. Except where mandated by government requirements, testing of all parameters of each product is not necessarily performed.

TI assumes no liability for applications assistance or customer product design. Customers are responsible for their products and applications using TI components. To minimize the risks associated with customer products and applications, customers should provide adequate design and operating safeguards.

TI does not warrant or represent that any license, either express or implied, is granted under any TI patent right, copyright, mask work right, or other TI intellectual property right relating to any combination, machine, or process in which TI products or services are used. Information published by TI regarding third-party products or services does not constitute a license from TI to use such products or services or a warranty or endorsement thereof. Use of such information may require a license from a third party under the patents or other intellectual property of the third party, or a license from TI under the patents or other intellectual property of TI.

Reproduction of TI information in TI data books or data sheets is permissible only if reproduction is without alteration and is accompanied by all associated warranties, conditions, limitations, and notices. Reproduction of this information with alteration is an unfair and deceptive business practice. TI is not responsible or liable for such altered documentation. Information of third parties may be subject to additional restrictions.

Resale of TI products or services with statements different from or beyond the parameters stated by TI for that product or service voids all express and any implied warranties for the associated TI product or service and is an unfair and deceptive business practice. TI is not responsible or liable for any such statements.

TI products are not authorized for use in safety-critical applications (such as life support) where a failure of the TI product would reasonably be expected to cause severe personal injury or death, unless officers of the parties have executed an agreement specifically governing such use. Buyers represent that they have all necessary expertise in the safety and regulatory ramifications of their applications, and acknowledge and agree that they are solely responsible for all legal, regulatory and safety-related requirements concerning their products and any use of TI products in such safety-critical applications, notwithstanding any applications-related information or support that may be provided by TI. Further, Buyers must fully indemnify TI and its representatives against any damages arising out of the use of TI products in such safety-critical applications.

TI products are neither designed nor intended for use in military/aerospace applications or environments unless the TI products are specifically designated by TI as military-grade or "enhanced plastic." Only products designated by TI as military-grade meet military specifications. Buyers acknowledge and agree that any such use of TI products which TI has not designated as military-grade is solely at the Buyer's risk, and that they are solely responsible for compliance with all legal and regulatory requirements in connection with such use.

TI products are neither designed nor intended for use in automotive applications or environments unless the specific TI products are designated by TI as compliant with ISO/TS 16949 requirements. Buyers acknowledge and agree that, if they use any non-designated products in automotive applications, TI will not be responsible for any failure to meet such requirements.

Following are URLs where you can obtain information on other Texas Instruments products and application solutions:

Products

| | |
|-----------------------------|--|
| Amplifiers | amplifier.ti.com |
| Data Converters | dataconverter.ti.com |
| DSP | dsp.ti.com |
| Clocks and Timers | www.ti.com/clocks |
| Interface | interface.ti.com |
| Logic | logic.ti.com |
| Power Mgmt | power.ti.com |
| Microcontrollers | microcontroller.ti.com |
| RFID | www.ti-rfid.com |
| RF/IF and ZigBee® Solutions | www.ti.com/lprf |

Applications

| | |
|--------------------|--|
| Audio | www.ti.com/audio |
| Automotive | www.ti.com/automotive |
| Broadband | www.ti.com/broadband |
| Digital Control | www.ti.com/digitalcontrol |
| Medical | www.ti.com/medical |
| Military | www.ti.com/military |
| Optical Networking | www.ti.com/opticalnetwork |
| Security | www.ti.com/security |
| Telephony | www.ti.com/telephony |
| Video & Imaging | www.ti.com/video |
| Wireless | www.ti.com/wireless |

Mailing Address: Texas Instruments, Post Office Box 655303, Dallas, Texas 75265
Copyright © 2008, Texas Instruments Incorporated