

**ebm-papst St. Georgen GmbH & Co. KG**

Hermann-Papst-Straße 1

74673 St. Georgen

Phone: +49 7724 81-0

Fax: +49 7724 81-1309

www.ebmpapst.com

info2@de.ebmpapst.com

Nominal data

Type	4214 NGN	
Nominal voltage	[VDC]	24
Speed	[min ⁻¹]	2750
Power input	[W]	4.3
Min. ambient temperature	[°C]	-20
Max. ambient temperature	[°C]	70
Air flow	[m ³ /h]	165
Sound power level	[B]	5.4
Sound pressure level	[dB(A)]	42

ml = max. load · me = max. efficiency · rfa = running at free air · cs = customer specs · cu = customer unit
Subject to alterations

Technical features

Dimensions	119 x 119 x 38 mm
General description	DC fan with electronically commutated external rotor motor. Commutation electronics completely integrated.
Connection line	2 single strands AWG 22, TR 64
Locked-rotor protection	Blocking and overload protection
Direction of protection	Left, looking at rotor
Direction of air flow	Air exhaust over bars
Bearing	Sintec sleeve bearing system
Lifetime L10 at 40 °C	60000 h
Lifetime L10 at maximum temperature	30000 h
Mass	0.230 kg
Material of impeller	Fiberglass-reinforced PA plastic
Motor protection	Reverse-polarity protected. The fan runs only if the polarity is correct.
Option	Speed signal
Approval	VDE, CSA, UL, CE

Product drawing

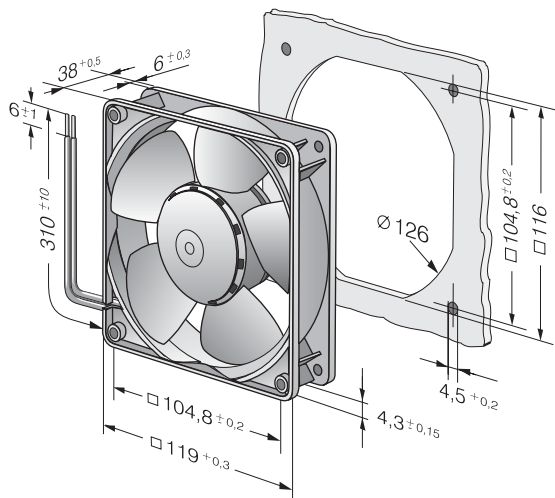

Charts: Air flow

