

7114 N

DC axial compact fan



ebm-papst St. Georgen GmbH & Co. KG

Hermann-Papst-Straße 1

74673 St. Georgen

Phone: +49 7724 81-0

Fax: +49 7724 81-1309

www.ebmpapst.com

info2@de.ebmpapst.com

Nominal data

Type	7114 N	
Nominal voltage	[VDC]	24
Speed	[min ⁻¹]	2850
Power input	[W]	12.0
Min. ambient temperature	[°C]	-25
Max. ambient temperature	[°C]	72
Air flow	[m ³ /h]	360
Sound power level	[B]	6.5
Sound pressure level	[dB(A)]	55

ml = max. load · me = max. efficiency · rfa = running at free air · cs = customer specs · cu = customer unit
Subject to alterations

Technical features

Dimensions	150 Ø x 38 mm
General description	Optional Vario-Pro: Highly flexible software configuration for the fan ensures an easily customizable solution to meet the individual requirements of your application. Electronic commutation completely integrated.
Connection line	Single strands AWG 22, TR 64, bared and tin-plated.
Locked-rotor protection	Electronic blocking protection
Direction of protection	Left, looking at rotor
Direction of air flow	Inlet over bars
Bearing	Ball bearings
Lifetime L10 at 40 °C	80000 h
Lifetime L10 at maximum temperature	37500 h
Mass	0.620 kg
Material of impeller	Aluminum
Motor protection	Protected against reverse polarity and locking.
Option	Speed signal
Approval	VDE, CSA, UL, CE

Product drawing

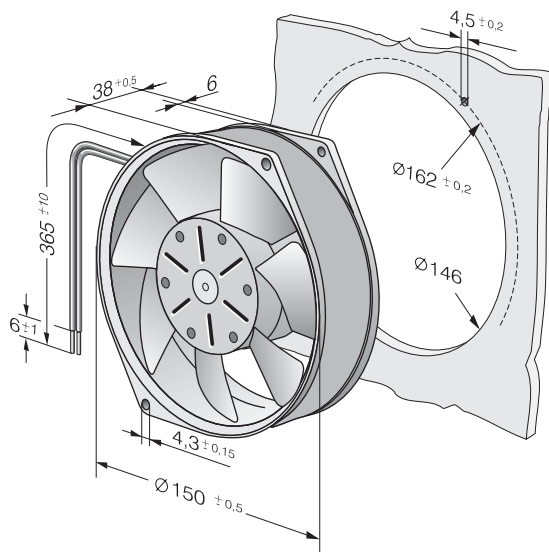

Charts: Air flow

