

**ebm-papst St. Georgen GmbH & Co. KG**

Hermann-Papst-Straße 1

74673 St. Georgen

Phone: +49 7724 81-0

Fax: +49 7724 81-1309

www.ebmpapst.com

info2@de.ebmpapst.com

**Nominal data**

Type	8312 G	
Nominal voltage	[VDC]	12
Speed	[min <sup>-1</sup> ]	3300
Power input	[W]	2.5
Min. ambient temperature	[°C]	-20
Max. ambient temperature	[°C]	75
Air flow	[m <sup>3</sup> /h]	54
Sound power level	[B]	5.2
Sound pressure level	[dB(A)]	36

ml = max. load · me = max. efficiency · rfa = running at free air · cs = customer specs · cu = customer unit  
Subject to alterations

**Technical features**

<b>Dimensions</b>	80 x 80 x 32 mm
<b>General description</b>	Optional Vario-Pro: Highly flexible software configuration for the fan ensures an easily customizable solution to meet the individual requirements of your application. Electronic commutation completely integrated.
<b>Connection line</b>	Single strands AWG 22, TR 64, bared and tin-plated.
<b>Locked-rotor protection</b>	Blocking and overload protection
<b>Direction of protection</b>	Right, looking at rotor
<b>Direction of air flow</b>	Air exhaust over bars
<b>Bearing</b>	Sintec sleeve bearing
<b>Lifetime L10 at 40 °C</b>	70000 h
<b>Lifetime L10 at maximum temperature</b>	30000 h
<b>Mass</b>	0.170 kg
<b>Material of impeller</b>	Fiberglass-reinforced PA plastic
<b>Motor protection</b>	Protected against reverse polarity and locking.
<b>Option</b>	Vario-Pro
<b>Approval</b>	VDE, CSA, UL, CE

## Product drawing

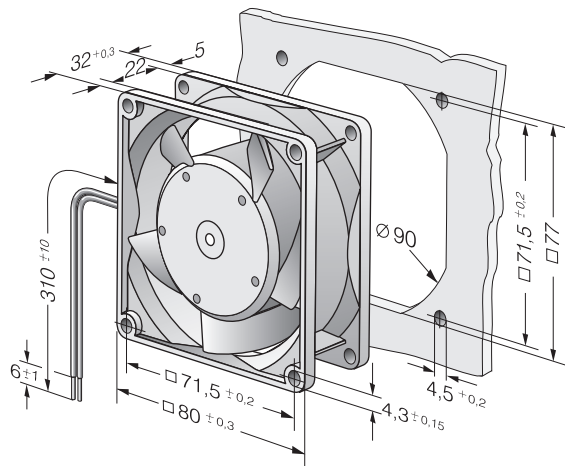

## Charts: Air flow

