

DV 5218 N

DC diagonal compact fan

sickled blades (S series)



ebm-papst St. Georgen GmbH & Co. KG

Hermann-Papst-Straße 1

74673 St. Georgen

Phone: +49 7724 81-0

Fax: +49 7724 81-1309

www.ebmpapst.com

info2@de.ebmpapst.com

Nominal data

Type	DV 5218 N	
Nominal voltage	[VDC]	48
Speed	[min ⁻¹]	5000
Power input	[W]	19.0
Min. ambient temperature	[°C]	-20
Max. ambient temperature	[°C]	65
Air flow	[m ³ /h]	270
Sound power level	[B]	6.4
Sound pressure level	[dB(A)]	56

ml = max. load · me = max. efficiency · rfa = running at free air · cs = customer specs · cu = customer unit
Subject to alterations

Technical features

Dimensions	127 x 127 x 38 mm
General description	Diagonal fan with low noise when there is a high pressure saddle curve. Rigid compression curve for high air flow at high counterpressure. Optional Vario-Pro: Highly flexible software configuration for the fan ensures an easily customizable solution to meet the individual requirements of your application. Electronic commutation completely integrated.
Connection line	Single strands AWG 22, TR 64, bared and tin-plated.
Locked-rotor protection	With electronic blocking and overload protection
Direction of protection	Left, looking at rotor
Direction of air flow	Air exhaust over bars
Bearing	Ball bearings
Lifetime L10 at 40 °C	70000 h
Lifetime L10 at maximum temperature	40000 h
Mass	0.415 kg
Material of impeller	Fiberglass-reinforced PA plastic, metal flange
Motor protection	Protected against reverse polarity and locking.
Option	Speed signal
Approval	VDE, CSA, UL, CE

DV 5218 N

DC diagonal compact fan

sickled blades (S series)

Product drawing

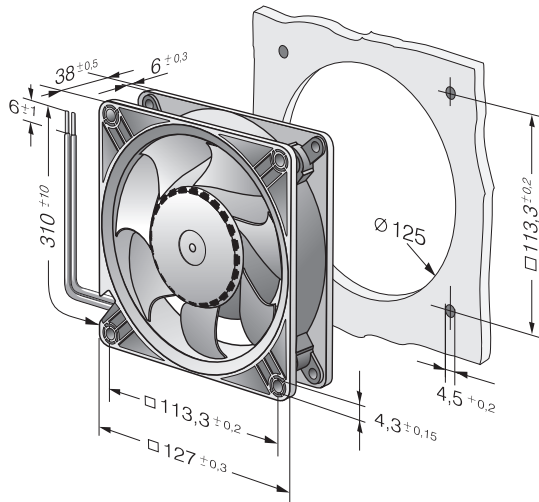

Charts: Air flow

