

Features

- Dual N-Channel MOSFET
- Low On-Resistance
- Very Low Gate Threshold Voltage, 1.2V max
- Low Input Capacitance
- Fast Switching Speed
- Low Input/Output Leakage
- Ultra-Small Surface Mount Package
- ESD Protected Gate
- **Lead Free By Design/RoHS Compliant (Note 2)**
- **"Green" Device (Note 3)**



TOP VIEW

SOT-563

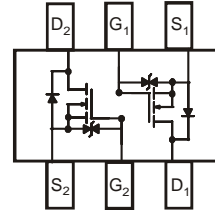
 TOP VIEW
Schematic and Transistor Diagram

Mechanical Data

- Case: SOT-563
- Case Material: Molded Plastic, "Green" Molding Compound. UL Flammability Classification Rating 94V-0
- Moisture Sensitivity: Level 1 per J-STD-020C
- Terminal Connections: See Diagram
- Terminals: Finish – Matte Tin annealed over Copper leadframe. Solderable per MIL-STD-202, Method 208
- Marking Information: See Page 3
- Ordering Information: See Page 3
- Weight: 0.006 grams (approximate)

Maximum Ratings @ $T_A = 25^\circ\text{C}$ unless otherwise specified

Characteristic	Symbol	Value	Unit
Drain Source Voltage	V_{DSS}	30	V
Gate-Source Voltage	V_{GSS}	± 10	V
Drain Current (Note 1)	I_D	400	mA

Thermal Characteristics @ $T_A = 25^\circ\text{C}$ unless otherwise specified

Total Power Dissipation (Note 1)	P_D	400	mW
Thermal Resistance, Junction to Ambient (Note 1)	$R_{\theta JA}$	313	$^\circ\text{C}/\text{W}$
Operating and Storage Temperature Range	T_J, T_{STG}	-55 to +150	$^\circ\text{C}$

Electrical Characteristics @ $T_A = 25^\circ\text{C}$ unless otherwise specified

Characteristic	Symbol	Min	Typ	Max	Unit	Test Condition
OFF CHARACTERISTICS (Note 4)						
Drain-Source Breakdown Voltage	BV_{DSS}	30	—	—	V	$V_{GS} = 0\text{V}, I_D = 10\mu\text{A}$
Zero Gate Voltage Drain Current	I_{DSS}	—	—	1	μA	$V_{DS} = 30\text{V}, V_{GS} = 0\text{V}$
Gate-Body Leakage	I_{GSS}	—	—	± 10 ± 500	μA nA	$V_{GS} = \pm 10\text{V}, V_{DS} = 0\text{V}$ $V_{GS} = \pm 5\text{V}, V_{DS} = 0\text{V}$
ON CHARACTERISTICS (Note 4)						
Gate Threshold Voltage	$V_{GS(th)}$	0.6	—	1.2	V	$V_{DS} = V_{GS}, I_D = 250\mu\text{A}$
Static Drain-Source On-Resistance	$R_{DS(ON)}$	—	—	2.2 1.5 1.2	Ω	$V_{GS} = 1.8\text{V}, I_D = 20\text{mA}$ $V_{GS} = 2.5\text{V}, I_D = 20\text{mA}$ $V_{GS} = 4.0\text{V}, I_D = 100\text{mA}$
Forward Transconductance	$ Y_{fs} $	100	—	—	mS	$V_{DS} = 10\text{V}, I_D = 0.1\text{A}$
Source-Drain Diode Forward Voltage	V_{SD}	0.5	—	1.4	V	$V_{GS} = 0\text{V}, I_S = 115\text{mA}$
DYNAMIC CHARACTERISTICS						
Input Capacitance	C_{iss}	—	39	—	pF	$V_{DS} = 3\text{V}, V_{GS} = 0\text{V}$ $f = 1.0\text{MHz}$
Output Capacitance	C_{oss}	—	10	—	pF	
Reverse Transfer Capacitance	C_{rss}	—	3.6	—	pF	
Switching Time	Turn-on Time	t_{on}	—	11	nS	$V_{DD} = 5\text{V}, I_D = 10\text{mA},$ $V_{GS} = 5\text{V}$
	Turn-off Time	t_{off}	—	51	nS	

- Notes:
1. Device mounted on FR-4 PCB, 1 inch x 0.85 inch x 0.062 inch; pad layout as shown on Diodes Inc. suggested pad layout document AP02001, which can be found on our website at <http://www.diodes.com/datasheets/ap02001.pdf>.
 2. No purposefully added lead.
 3. Diodes Inc.'s "Green" policy can be found on our website at http://www.diodes.com/products/lead_free/index.php.
 4. Short duration pulse test used to minimize self-heating effect.

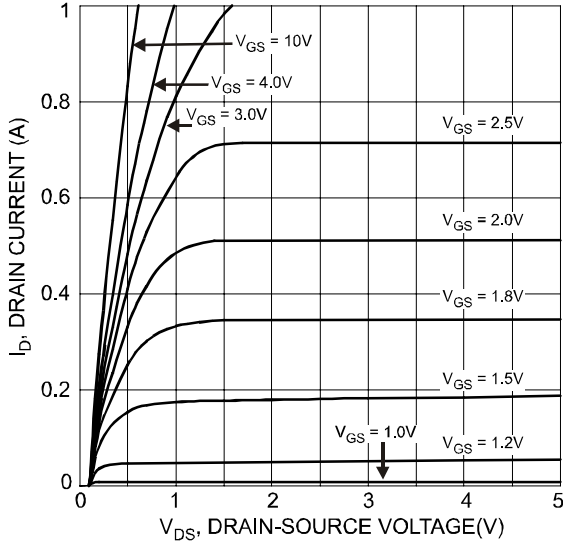

Fig. 1 Typical Output Characteristics

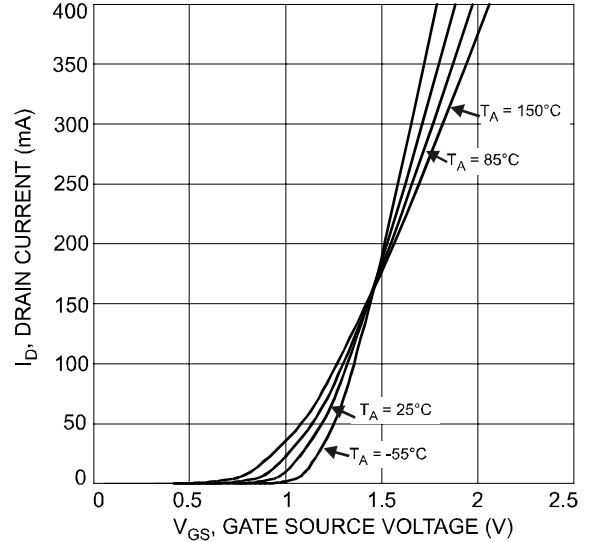

Fig. 2 Typical Transfer Characteristics

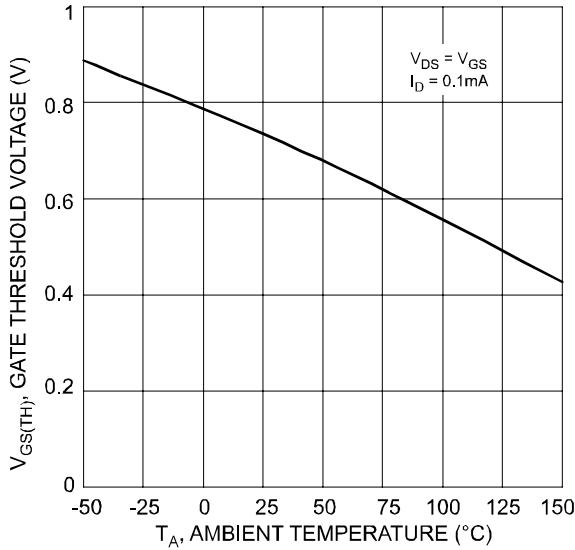

Fig. 3 Gate Threshold Voltage vs. Ambient Temperature

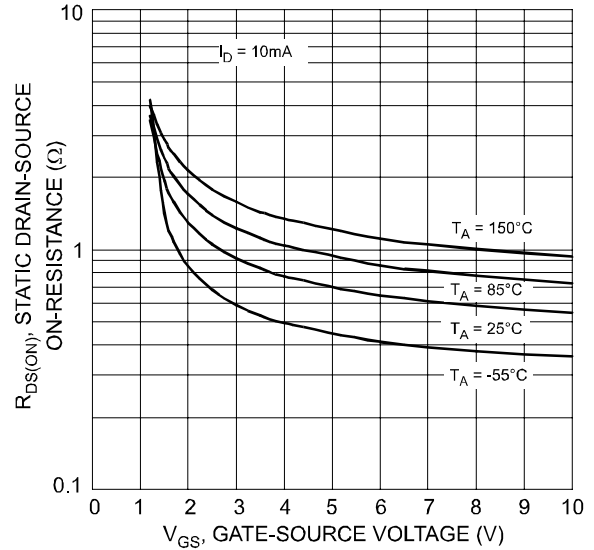

Fig. 4 Static Drain-Source On-Resistance vs. Gate-Source Voltage

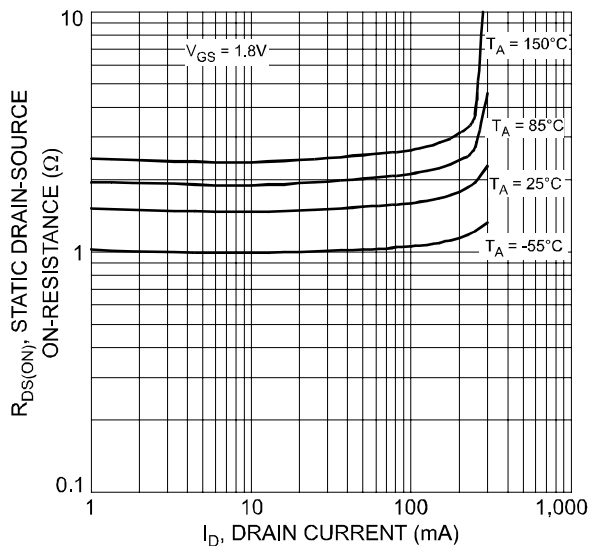

Fig. 5 Static Drain-Source On-Resistance vs. Drain Current

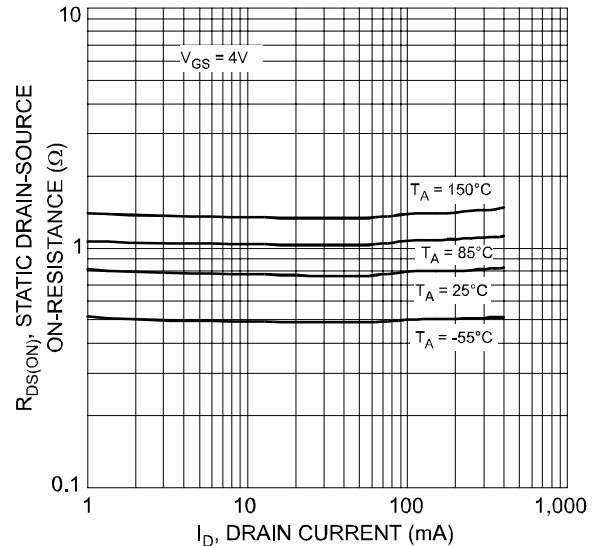

Fig. 6 Static Drain-Source On-Resistance vs. Drain Current

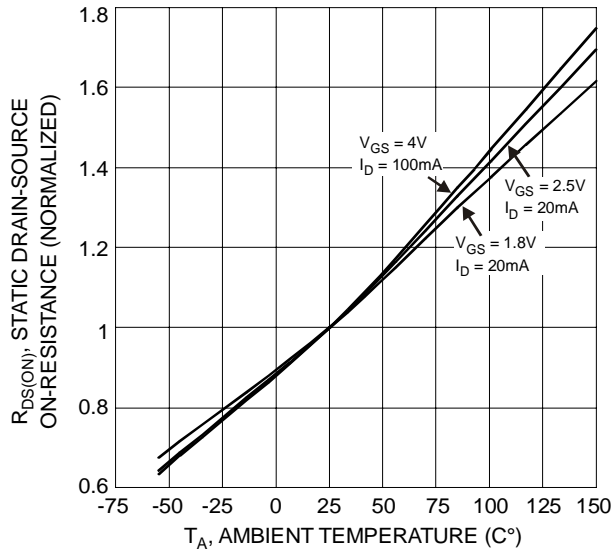

Fig. 7 Normalized Static Drain-Source On-Resistance vs. Ambient Temperature

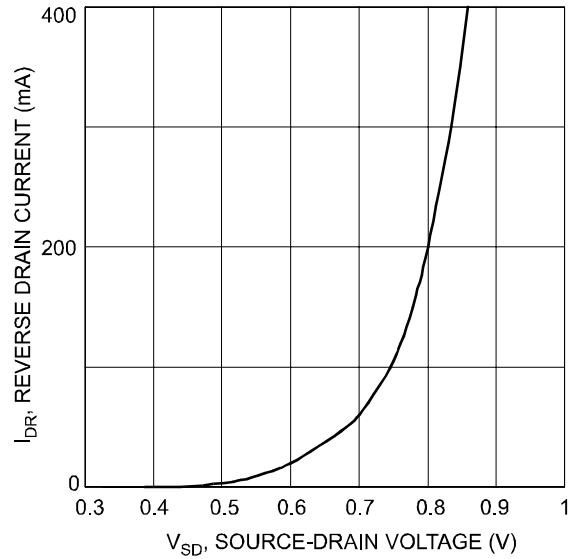

Fig. 8 Reverse Drain Current vs. Source-Drain Voltage

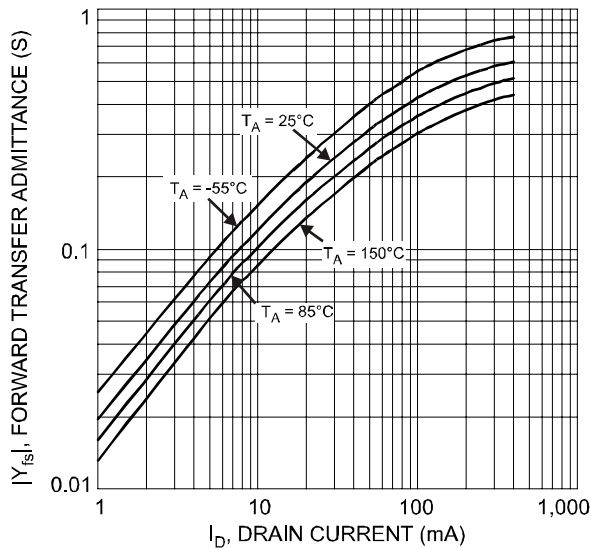

Fig. 9 Forward Transfer Admittance vs. Drain Current

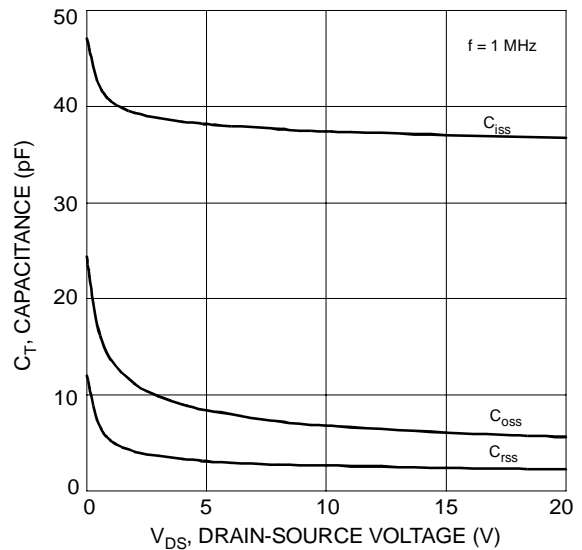

Fig. 10 Typical Capacitance

Ordering Information (Note 5)

Part Number	Case	Packaging
DMN32D2LV-7	SOT-563	3000/Tape & Reel

Notes: 5. For packaging details, go to our website at <http://www.diodes.com/datasheets/ap02007.pdf>.

Marking Information (Note 6)

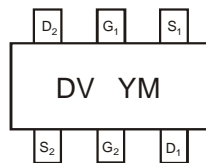

DV = Product Type Marking Code (See Note 6)
 YM = Date Code Marking
 Y = Year ex: U = 2007
 M = Month ex: 9 = September

Notes: 6. Package is non-polarized. Parts may be on reel in orientation illustrated, 180° rotated, or mixed (both ways).

Date Code Key

Year	2007	2008	2009	2010	2011	2012
Code	U	V	W	X	Y	Z

Month	Jan	Feb	Mar	Apr	May	Jun	Jul	Aug	Sep	Oct	Nov	Dec
Code	1	2	3	4	5	6	7	8	9	O	N	D

Package Outline Dimensions

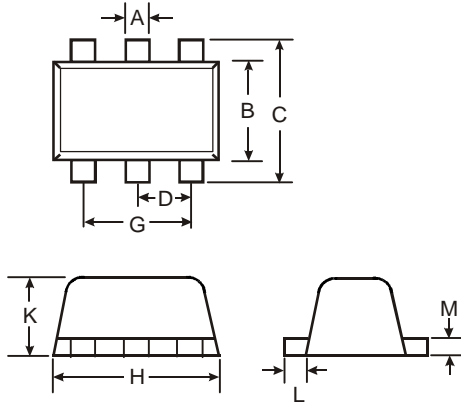

SOT-563			
Dim	Min	Max	Typ
A	0.15	0.30	0.20
B	1.10	1.25	1.20
C	1.55	1.70	1.60
D	0.50		
G	0.90	1.10	1.00
H	1.50	1.70	1.60
K	0.55	0.60	0.60
L	0.10	0.30	0.20
M	0.10	0.18	0.11
All Dimensions in mm			

Suggested Pad Layout

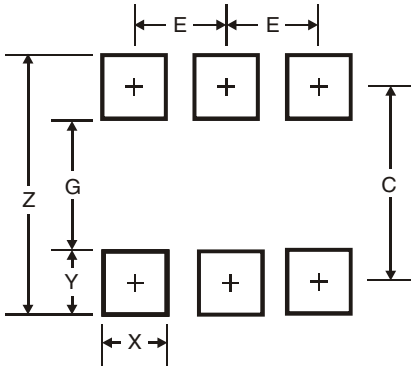

Dimensions	Value (in mm)
Z	2.2
G	1.2
X	0.375
Y	0.5
C	1.7
E	0.5

IMPORTANT NOTICE

Diodes Incorporated and its subsidiaries reserve the right to make modifications, enhancements, improvements, corrections or other changes without further notice to any product herein. Diodes Incorporated does not assume any liability arising out of the application or use of any product described herein; neither does it convey any license under its patent rights, nor the rights of others. The user of products in such applications shall assume all risks of such use and will agree to hold Diodes Incorporated and all the companies whose products are represented on our website, harmless against all damages.

LIFE SUPPORT

Diodes Incorporated products are not authorized for use as critical components in life support devices or systems without the expressed written approval of the President of Diodes Incorporated.