

IRF5852PbF

HEXFET® Power MOSFET

- Ultra Low On-Resistance
- Dual N-Channel MOSFET
- Surface Mount
- Available in Tape & Reel
- Low Gate Charge
- Lead-Free

V _{DSS}	R _{DS(on)} max (Ω)	I _D
20 V	0.090@V _{GS} = 4.5V	2.7A
	0.120@V _{GS} = 2.5V	2.2A

Description

These N-channel MOSFETs from International Rectifier utilize advanced processing techniques to achieve the extremely low on-resistance per silicon area. This benefit provides the designer with an extremely efficient device for use in battery and load management applications.

This Dual TSOP-6 package is ideal for applications where printed circuit board space is at a premium and where maximum functionality is required. With two die per package, the IRF5852 can provide the functionality of two SOT-23 packages in a smaller footprint. Its unique thermal design and R_{DS(on)} reduction enables an increase in current-handling capability.

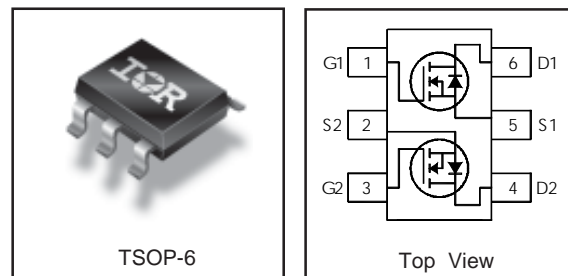

Absolute Maximum Ratings

	Parameter	Max.	Units
V _{DS}	Drain- Source Voltage	20	V
I _D @ T _A = 25°C	Continuous Drain Current, V _{GS} @ 4.5V	2.7	A
I _D @ T _A = 70°C	Continuous Drain Current, V _{GS} @ 4.5V	2.2	
I _{DM}	Pulsed Drain Current ①	11	
P _D @ T _A = 25°C	Power Dissipation ③	0.96	W
P _D @ T _A = 70°C	Power Dissipation ③	0.62	
	Linear Derating Factor	7.7	mW/°C
V _{GS}	Gate-to-Source Voltage	± 12	V
T _J , T _{STG}	Junction and Storage Temperature Range	-55 to + 150	°C

Thermal Resistance

	Parameter	Max.	Units
R _{θJA}	Maximum Junction-to-Ambient ③	130	°C/W

IRF5852PbF

International
IR Rectifier

Electrical Characteristics @ $T_J = 25^\circ\text{C}$ (unless otherwise specified)

	Parameter	Min.	Typ.	Max.	Units	Conditions
$V_{(BR)DSS}$	Drain-to-Source Breakdown Voltage	20	—	—	V	$V_{GS} = 0V, I_D = 250\mu A$
$\Delta V_{(BR)DSS}/\Delta T_J$	Breakdown Voltage Temp. Coefficient	—	0.016	—	V/°C	Reference to $25^\circ\text{C}, I_D = 1\text{mA}$
$R_{DS(on)}$	Static Drain-to-Source On-Resistance	—	—	0.090	Ω	$V_{GS} = 4.5V, I_D = 2.7A$ ②
		—	—	0.120		$V_{GS} = 2.5V, I_D = 2.2A$ ②
$V_{GS(th)}$	Gate Threshold Voltage	0.60	—	1.25	V	$V_{DS} = V_{GS}, I_D = 250\mu A$
g_{fs}	Forward Transconductance	5.2	—	—	S	$V_{DS} = 10V, I_D = 2.7A$
I_{DSS}	Drain-to-Source Leakage Current	—	—	1.0	μA	$V_{DS} = 16V, V_{GS} = 0V$
		—	—	25		$V_{DS} = 16V, V_{GS} = 0V, T_J = 70^\circ\text{C}$
I_{GSS}	Gate-to-Source Forward Leakage	—	—	100	nA	$V_{GS} = 12V$
	Gate-to-Source Reverse Leakage	—	—	-100		$V_{GS} = -12V$
Q_g	Total Gate Charge	—	4.0	6.0	nC	$I_D = 2.7A$
Q_{gs}	Gate-to-Source Charge	—	0.95	—		$V_{DS} = 16V$
Q_{gd}	Gate-to-Drain ("Miller") Charge	—	0.88	—		$V_{GS} = 4.5V$ ②
$t_{d(on)}$	Turn-On Delay Time	—	6.6	—	ns	$V_{DD} = 10V$ ②
t_r	Rise Time	—	1.2	—		$I_D = 1.0A$
$t_{d(off)}$	Turn-Off Delay Time	—	15	—		$R_G = 6.2\Omega$
t_f	Fall Time	—	2.4	—		$V_{GS} = 4.5V$
C_{iss}	Input Capacitance	—	400	—	pF	$V_{GS} = 0V$
C_{oss}	Output Capacitance	—	48	—		$V_{DS} = 15V$
C_{rss}	Reverse Transfer Capacitance	—	32	—		$f = 1.0\text{MHz}$

Source-Drain Ratings and Characteristics

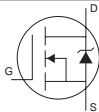
	Parameter	Min.	Typ.	Max.	Units	Conditions
I_S	Continuous Source Current (Body Diode)	—	—	0.96	A	MOSFET symbol showing the integral reverse p-n junction diode. 
I_{SM}	Pulsed Source Current (Body Diode) ①	—	—	11		
V_{SD}	Diode Forward Voltage	—	—	1.2	V	$T_J = 25^\circ\text{C}, I_S = 0.96A, V_{GS} = 0V$ ②
t_{rr}	Reverse Recovery Time	—	25	38	ns	$T_J = 25^\circ\text{C}, I_F = 0.96A$
Q_{rr}	Reverse Recovery Charge	—	6.5	9.8	nC	$di/dt = 100A/\mu s$ ②

Notes:

① Repetitive rating; pulse width limited by max. junction temperature.

② Pulse width $\leq 400\mu s$; duty cycle $\leq 2\%$.

③ Surface mounted on FR-4 board, $t \leq 5\text{sec}$.

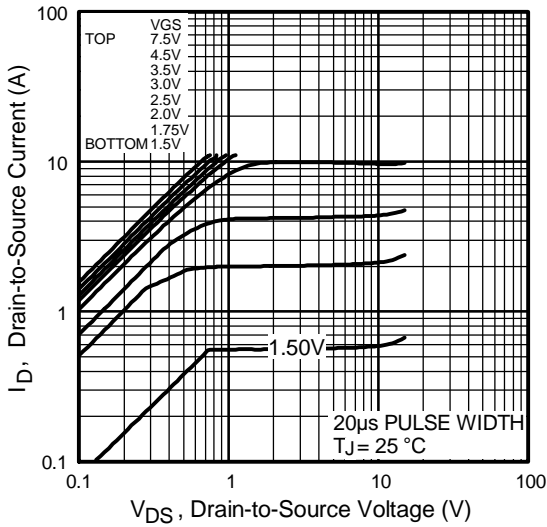

Fig 1. Typical Output Characteristics

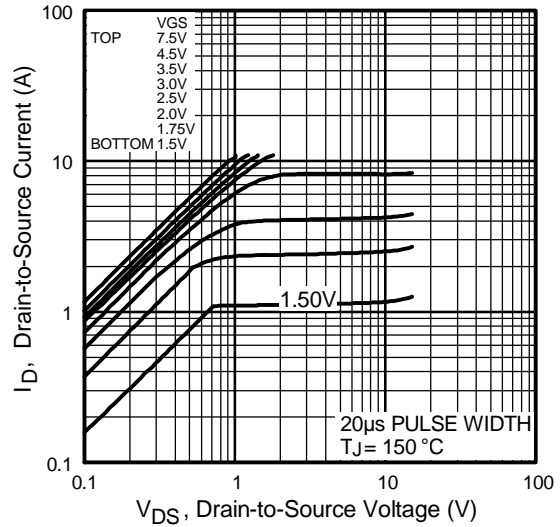

Fig 2. Typical Output Characteristics

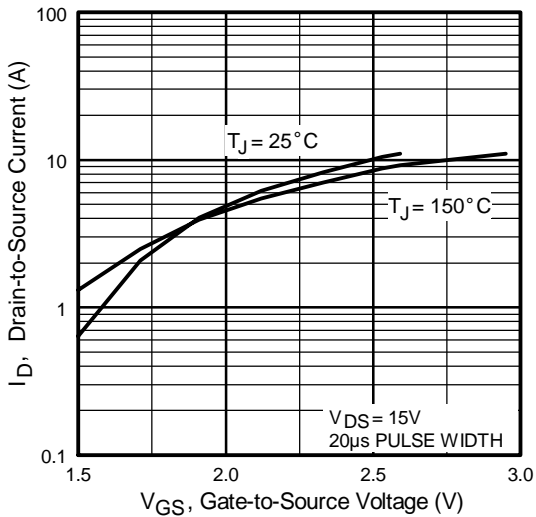

Fig 3. Typical Transfer Characteristics

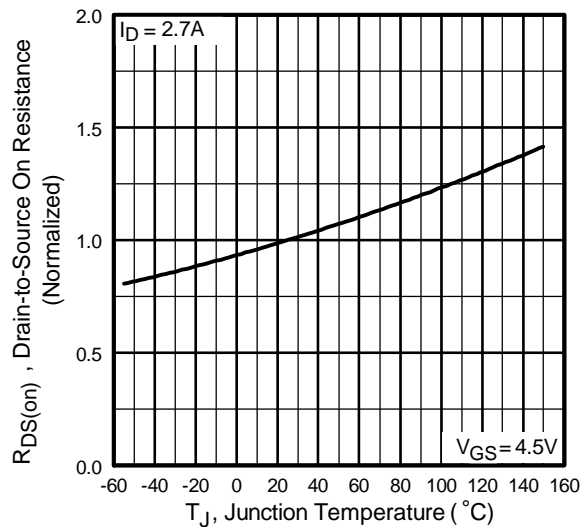

Fig 4. Normalized On-Resistance Vs. Temperature

IRF5852PbF

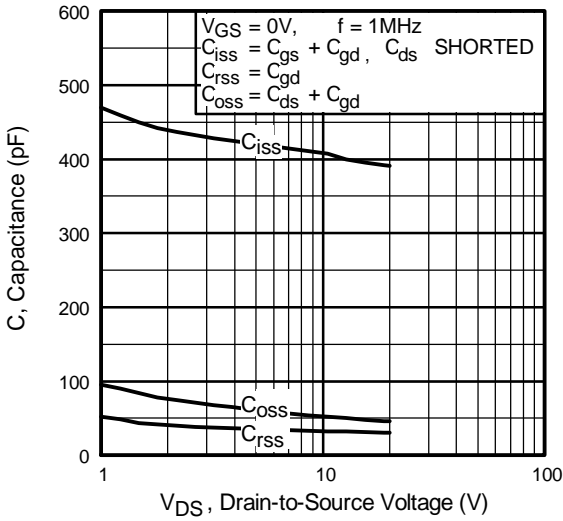

Fig 5. Typical Capacitance Vs. Drain-to-Source Voltage

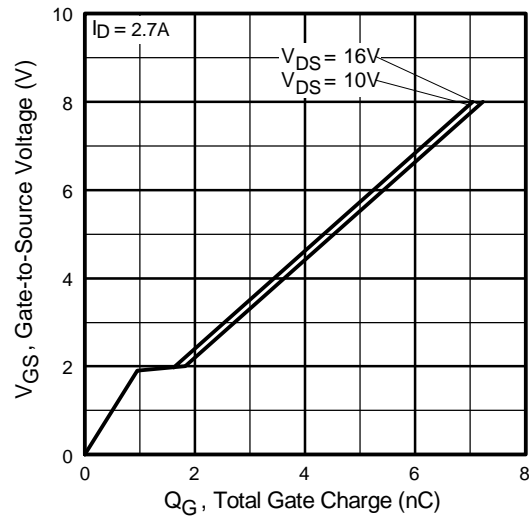

Fig 6. Typical Gate Charge Vs. Gate-to-Source Voltage

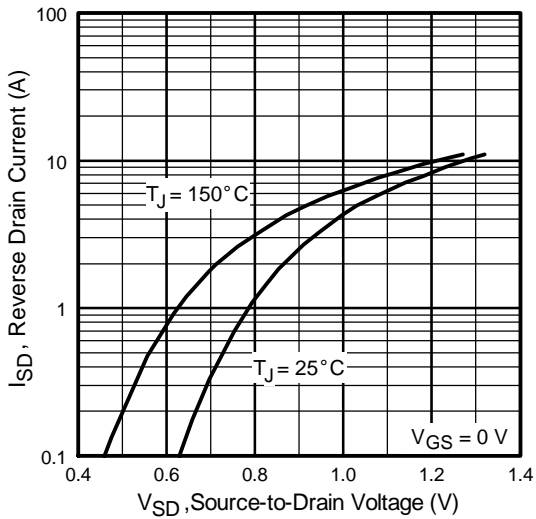

Fig 7. Typical Source-Drain Diode Forward Voltage

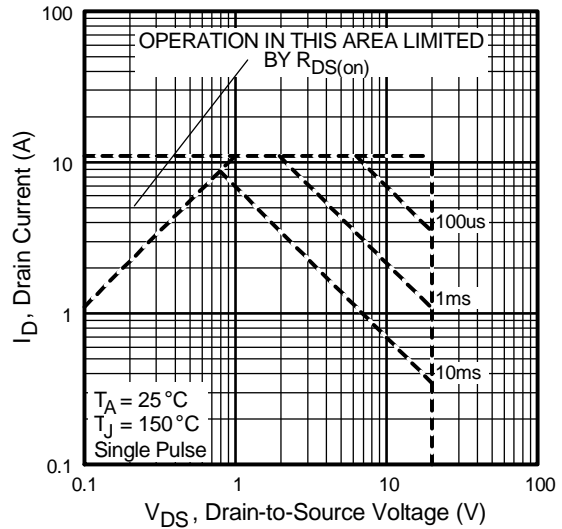

Fig 8. Maximum Safe Operating Area

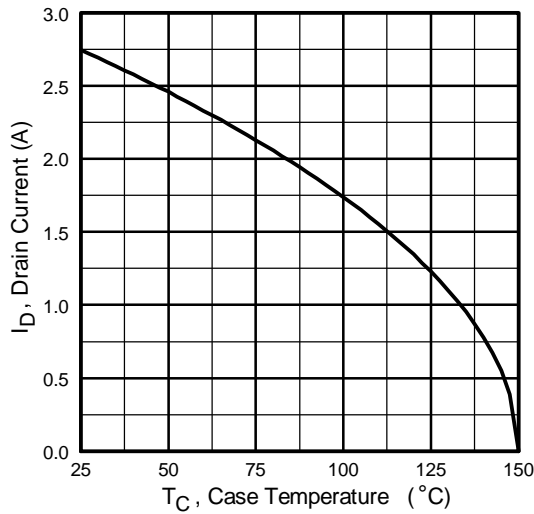

Fig 9. Maximum Drain Current Vs. Case Temperature

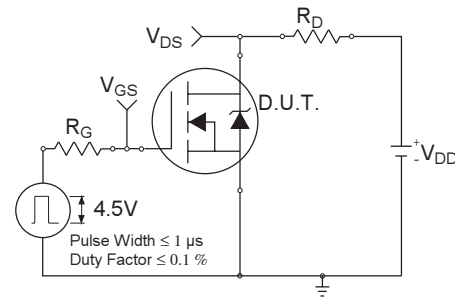

Fig 10a. Switching Time Test Circuit

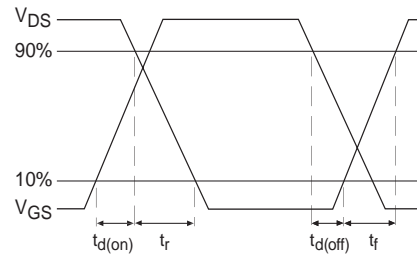

Fig 10b. Switching Time Waveforms

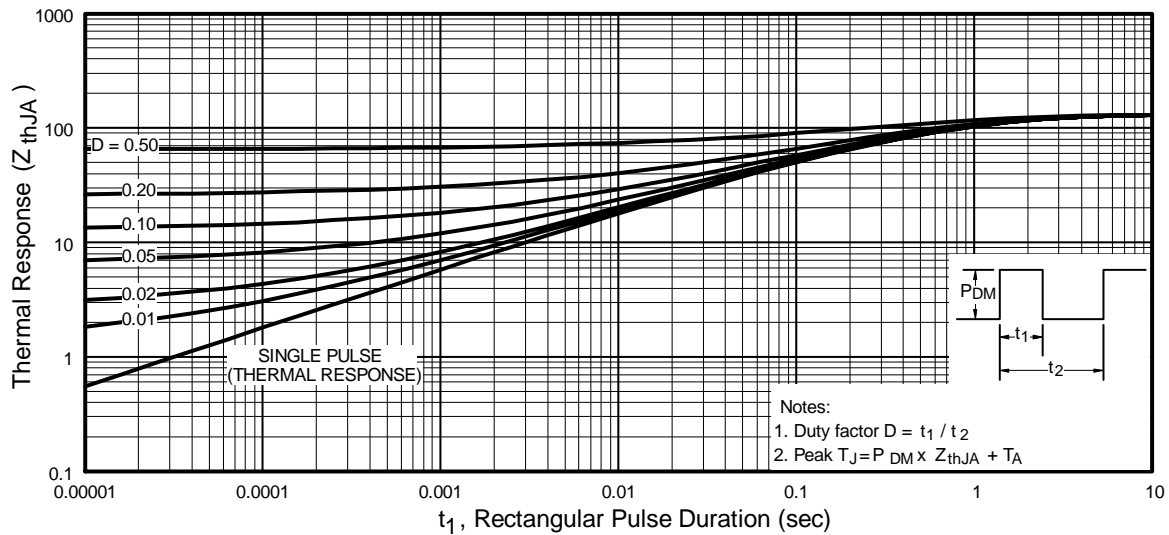

Fig 10. Typical Effective Transient Thermal Impedance, Junction-to-Ambient

IRF5852PbF

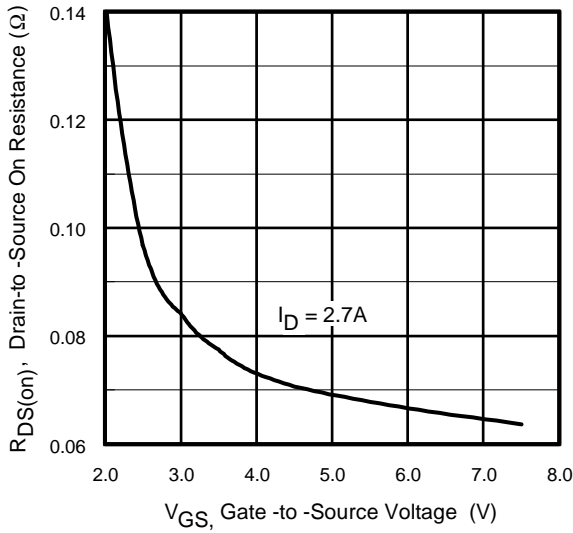

Fig 11. Typical On-Resistance Vs. Gate Voltage

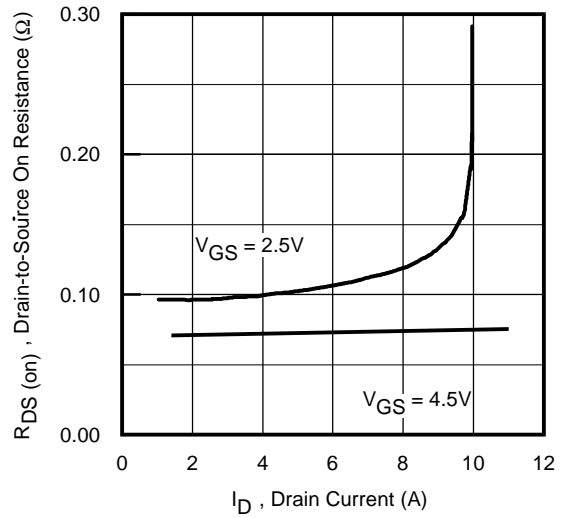

Fig 12. Typical On-Resistance Vs. Drain Current

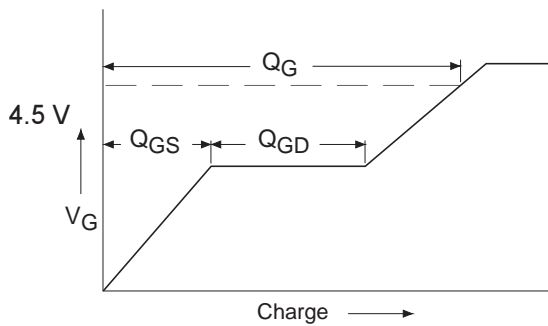

Fig 13a. Basic Gate Charge Waveform

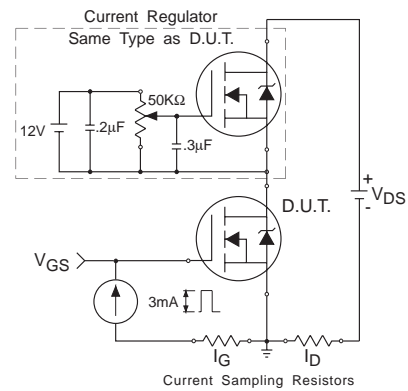

Fig 13b. Gate Charge Test Circuit

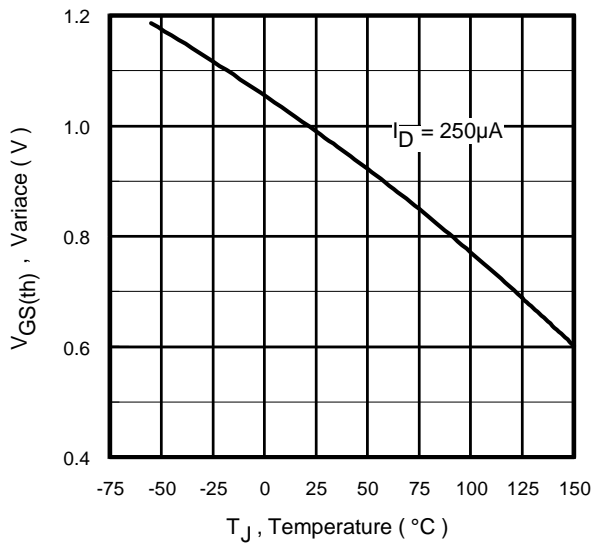

Fig 14. Threshold Voltage Vs. Temperature

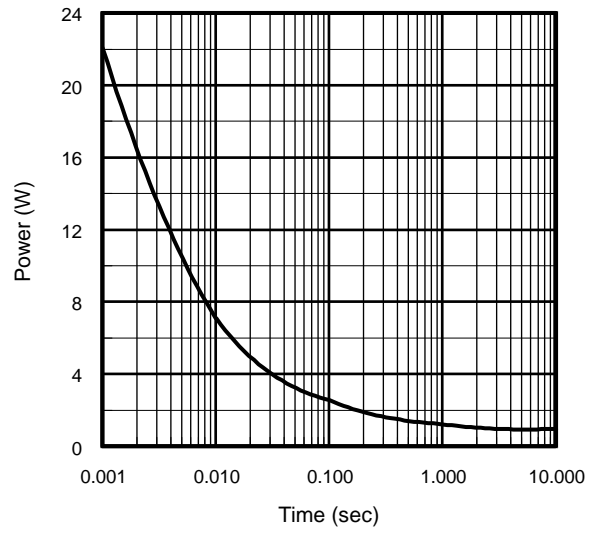
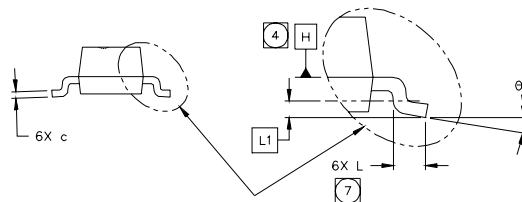
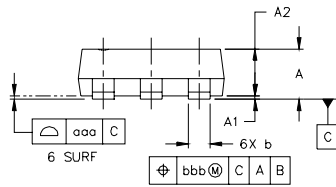
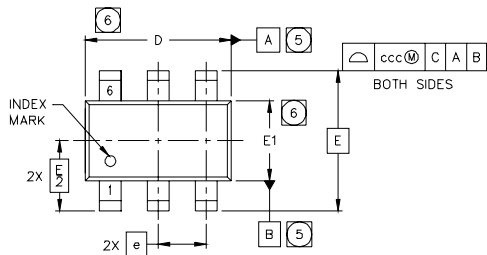

Fig 15. Typical Power Vs. Time

IRF5852PbF

TSOP-6 Package Outline



SYMBOL	MO-193AA DIMENSIONS					
	MILLIMETERS			INCHES		
	MIN	NOM	MAX	MIN	NOM	MAX
A	---	---	1.10	---	---	.0433
A1	0.01	---	0.10	.0004	---	.0039
A2	0.80	0.90	1.00	.0315	.0354	.0393
b	0.25	---	0.50	.0099	---	.0196
c	0.10	---	0.26	.004	---	.010
D	2.90	3.00	3.10	.115	.118	.122
E	2.75 BSC			.108 BSC		
E1	1.30	1.50	1.70	.052	.059	.066
e	1.00 BSC			.039 BSC		
L	0.20	0.40	0.60	.0079	.0157	.0236
L1	0.30 BSC			.0118 BSC		
θ	0°	---	8°	0°	---	8°
aaa	0.10			.004		
bbb	0.15			.006		
ccc	0.25			.010		

W = (1-26) IF PRECEDED BY LAST DIGIT OF CALENDAR YEAR

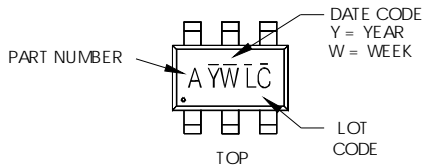

PART NUMBER CODE REFERENCE:

- A = S13443DV
- B = IRF5800
- C = IRF5850
- D = IRF5851
- E = IRF5852
- F = IRF5801
- I = IRF5805
- J = IRF5806
- K = IRF5810
- L = IRF5804
- M = IRF5803
- N = IRF5802

Note: A line above the work week (as shown here) indicates Lead-Free.

YEAR	Y	WORK WEEK	W
2001	1	01	A
2002	2	02	B
2003	3	03	C
2004	4	04	D
2005	5		
2006	6		
2007	7		
2008	8		
2009	9		
2010	0	24	X
		25	Y
		26	Z

W = (27-52) IF PRECEDED BY A LETTER

YEAR	Y	WORK WEEK	W
2001	A	27	A
2002	B	28	B
2003	C	29	C
2004	D	30	D
2005	E		
2006	F		
2007	G		
2008	H		
2009	J		
2010	K	50	X
		51	Y
		52	Z

TSOP-6 Tape & Reel Information

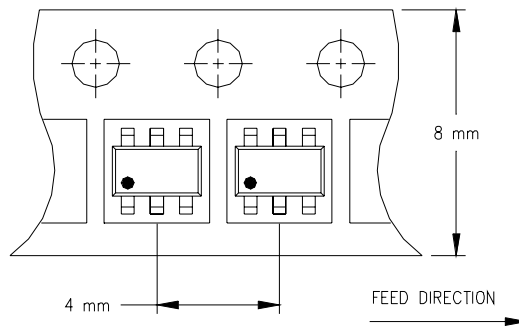

NOTES:

1. OUTLINE CONFORMS TO EIA-481 & EIA-541.

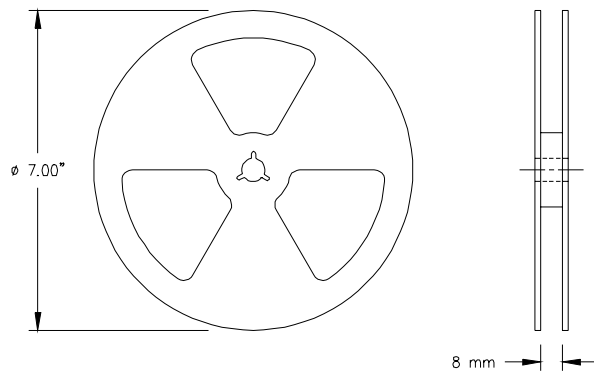

NOTES:

1. OUTLINE CONFORMS TO EIA-481 & EIA-541.

Data and specifications subject to change without notice.
This product has been designed and qualified for the Consumer market.
Qualification Standards can be found on IR's Web site.