

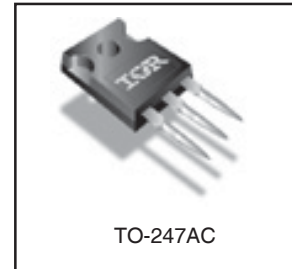
**Applications**

- Zero Voltage Switching SMPS
- Telecom and Server Power Supplies
- Uninterruptible Power Supplies
- Motor Control applications

V <sub>DSS</sub>	R <sub>DS(on) typ.</sub>	T <sub>rr typ.</sub>	I <sub>D</sub>
500V	0.190Ω	170ns	23A

**Features and Benefits**

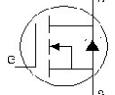
- SuperFast body diode eliminates the need for external diodes in ZVS applications.
- Lower Gate charge results in simpler drive requirements.
- Enhanced dv/dt capabilities offer improved ruggedness.
- Higher Gate voltage threshold offers improved noise immunity.



**Absolute Maximum Ratings**

	Parameter	Max.	Units
I <sub>D</sub> @ T <sub>C</sub> = 25°C	Continuous Drain Current, V <sub>GS</sub> @ 10V	23	A
I <sub>D</sub> @ T <sub>C</sub> = 100°C	Continuous Drain Current, V <sub>GS</sub> @ 10V	15	
I <sub>DM</sub>	Pulsed Drain Current ①	92	
P <sub>D</sub> @ T <sub>C</sub> = 25°C	Power Dissipation	370	W
	Linear Derating Factor	2.9	W/°C
V <sub>GS</sub>	Gate-to-Source Voltage	± 30	V
dv/dt	Peak Diode Recovery dv/dt ③	21	V/ns
T <sub>J</sub>	Operating Junction and	-55 to + 150	°C
T <sub>STG</sub>	Storage Temperature Range		
	Soldering Temperature, for 10 seconds	300 (1.6mm from case )	
	Mounting torque, 6-32 or M3 screw	10lb·in (1.1N·m)	

**Diode Characteristics**

Symbol	Parameter	Min.	Typ.	Max.	Units	Conditions
I <sub>S</sub>	Continuous Source Current (Body Diode)	—	—	23	A	MOSFET symbol showing the integral reverse p-n junction diode. 
I <sub>SM</sub>	Pulsed Source Current (Body Diode) ①	—	—	92		
V <sub>SD</sub>	Diode Forward Voltage	—	—	1.5	V	T <sub>J</sub> = 25°C, I <sub>S</sub> = 14A, V <sub>GS</sub> = 0V ④
t <sub>rr</sub>	Reverse Recovery Time	—	170	250	ns	T <sub>J</sub> = 25°C, I <sub>F</sub> = 23A
		—	220	330		T <sub>J</sub> = 125°C, di/dt = 100A/μs ④
Q <sub>rr</sub>	Reverse Recovery Charge	—	560	840	nC	T <sub>J</sub> = 25°C, I <sub>S</sub> = 23A, V <sub>GS</sub> = 0V ④
		—	980	1500		T <sub>J</sub> = 125°C, di/dt = 100A/μs ④
I <sub>RRM</sub>	Reverse Recovery Current	—	7.6	11	A	T <sub>J</sub> = 25°C
t <sub>on</sub>	Forward Turn-On Time	Intrinsic turn-on time is negligible (turn-on is dominated by LS+LD)				

# IRFP23N50L

International  
IR Rectifier

Static @  $T_J = 25^\circ\text{C}$  (unless otherwise specified)

Symbol	Parameter	Min.	Typ.	Max.	Units	Conditions
$V_{(BR)DSS}$	Drain-to-Source Breakdown Voltage	500	—	—	V	$V_{GS} = 0V, I_D = 250\mu A$
$\Delta V_{(BR)DSS}/\Delta T_J$	Breakdown Voltage Temp. Coefficient	—	0.27	—	V/ $^\circ\text{C}$	Reference to $25^\circ\text{C}, I_D = 1\text{mA}$
$R_{DS(on)}$	Static Drain-to-Source On-Resistance	—	0.190	0.235	$\Omega$	$V_{GS} = 10V, I_D = 14A$ ④
$V_{GS(th)}$	Gate Threshold Voltage	3.0	—	5.0	V	$V_{DS} = V_{GS}, I_D = 250\mu A$
$I_{DSS}$	Drain-to-Source Leakage Current	—	—	50	$\mu A$	$V_{DS} = 500V, V_{GS} = 0V$
		—	—	2.0	mA	$V_{DS} = 400V, V_{GS} = 0V, T_J = 125^\circ\text{C}$
$I_{GSS}$	Gate-to-Source Forward Leakage	—	—	100	nA	$V_{GS} = 30V$
	Gate-to-Source Reverse Leakage	—	—	-100	nA	$V_{GS} = -30V$
$R_G$	Internal Gate Resistance	—	1.2	—	$\Omega$	$f = 1\text{MHz}, \text{open drain}$

Dynamic @  $T_J = 25^\circ\text{C}$  (unless otherwise specified)

Symbol	Parameter	Min.	Typ.	Max.	Units	Conditions
gfs	Forward Transconductance	12	—	—	S	$V_{DS} = 50V, I_D = 14A$
$Q_g$	Total Gate Charge	—	—	150	nC	$I_D = 23A$ $V_{DS} = 400V$ $V_{GS} = 10V, \text{See Fig. 7 \& 15 } \textcircled{4}$
$Q_{gs}$	Gate-to-Source Charge	—	—	44		
$Q_{gd}$	Gate-to-Drain ("Miller") Charge	—	—	72		
$t_{d(on)}$	Turn-On Delay Time	—	26	—	ns	$V_{DD} = 250V$ $I_D = 23A$ $R_G = 6.0\Omega$ $V_{GS} = 10V, \text{See Fig. 11a \& 11b } \textcircled{4}$
$t_r$	Rise Time	—	94	—		
$t_{d(off)}$	Turn-Off Delay Time	—	53	—		
$t_f$	Fall Time	—	45	—		
$C_{iss}$	Input Capacitance	—	3600	—	pF	$V_{GS} = 0V$ $V_{DS} = 25V$ $f = 1.0\text{MHz}, \text{See Fig. 5}$ $V_{GS} = 0V, V_{DS} = 1.0V, f = 1.0\text{MHz}$ $V_{GS} = 0V, V_{DS} = 400V, f = 1.0\text{MHz}$ $V_{GS} = 0V, V_{DS} = 0V \text{ to } 400V \textcircled{5}$
$C_{oss}$	Output Capacitance	—	380	—		
$C_{riss}$	Reverse Transfer Capacitance	—	37	—		
$C_{oss}$	Output Capacitance	—	4800	—		
$C_{oss}$	Output Capacitance	—	100	—		
$C_{oss \text{ eff.}}$	Effective Output Capacitance	—	220	—		
$C_{oss \text{ eff. (ER)}}$	Effective Output Capacitance (Energy Related)	—	160	—		

## Avalanche Characteristics

Symbol	Parameter	Typ.	Max.	Units
$E_{AS}$	Single Pulse Avalanche Energy ②	—	410	mJ
$I_{AR}$	Avalanche Current ①	—	23	A
$E_{AR}$	Repetitive Avalanche Energy ①	—	37	mJ

## Thermal Resistance

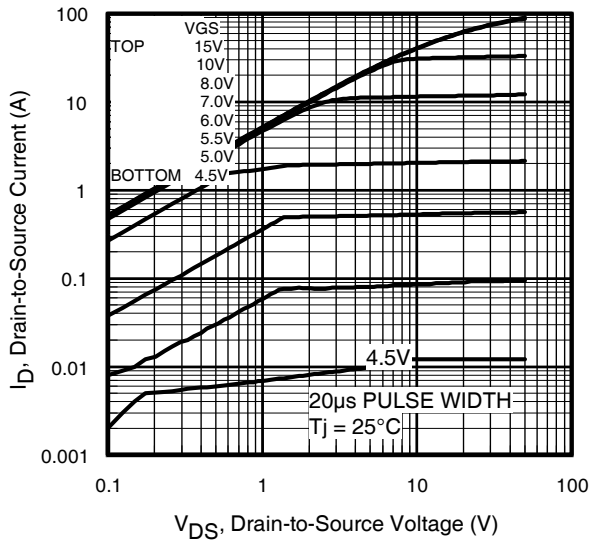
Symbol	Parameter	Typ.	Max.	Units
$R_{\theta JC}$	Junction-to-Case	—	0.34	$^\circ\text{C/W}$
$R_{\theta CS}$	Case-to-Sink, Flat, Greased Surface	0.24	—	
$R_{\theta JA}$	Junction-to-Ambient	—	40	

### Notes:

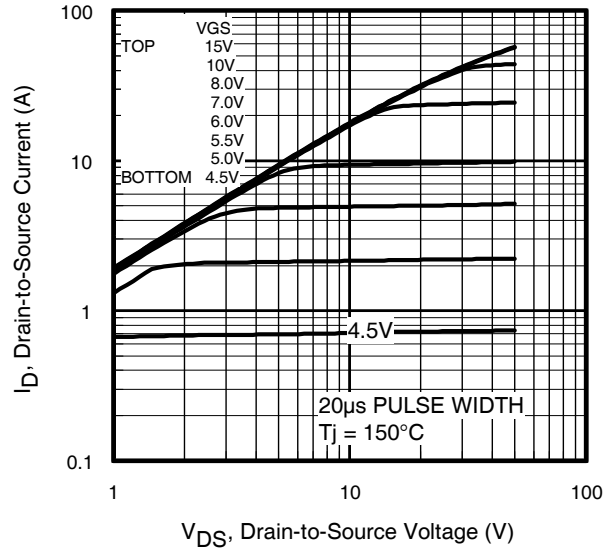
- ① Repetitive rating; pulse width limited by max. junction temperature. (See Fig. 11).
- ② Starting  $T_J = 25^\circ\text{C}$ ,  $L = 1.5\text{mH}$ ,  $R_G = 25\Omega$ ,  $I_{AS} = 23A$ ,  $dv/dt = 21V/ns$ . (See Figure 12).
- ③  $I_{SD} \leq 23A$ ,  $di/dt \leq 650A/\mu s$ ,  $V_{DD} \leq V_{(BR)DSS}$ ,  $T_J \leq 150^\circ\text{C}$ .

④ Pulse width  $\leq 300\mu s$ ; duty cycle  $\leq 2\%$ .

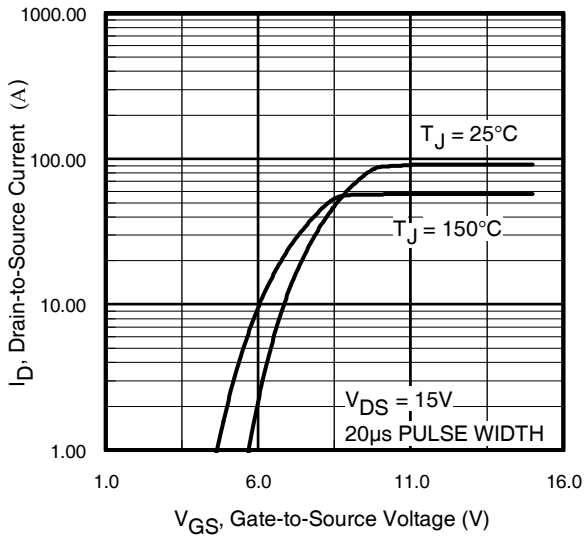
⑤  $C_{oss \text{ eff.}}$  is a fixed capacitance that gives the same charging time as  $C_{oss}$  while  $V_{DS}$  is rising from 0 to 80%  $V_{DSS}$ .  
 $C_{oss \text{ eff. (ER)}}$  is a fixed capacitance that stores the same energy as  $C_{oss}$  while  $V_{DS}$  is rising from 0 to 80%  $V_{DSS}$ .



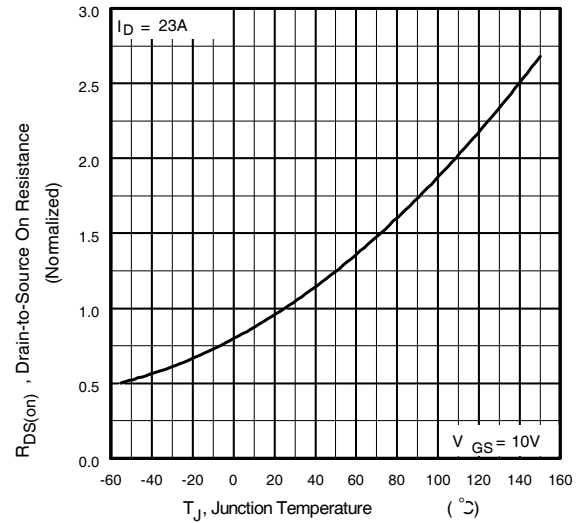
**Fig 1.** Typical Output Characteristics



**Fig 2.** Typical Output Characteristics

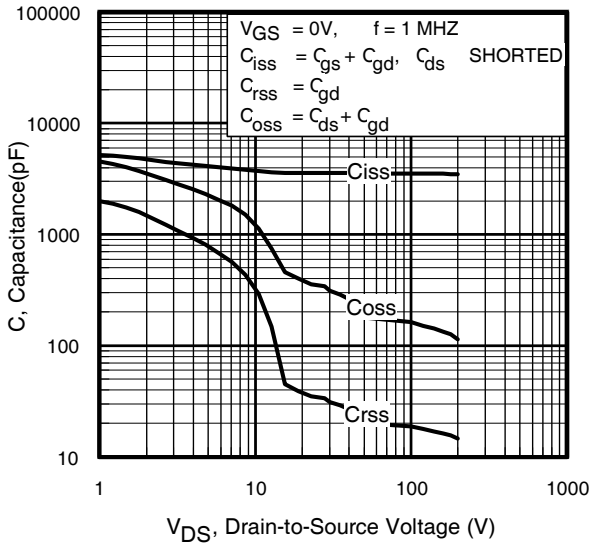


**Fig 3.** Typical Transfer Characteristics

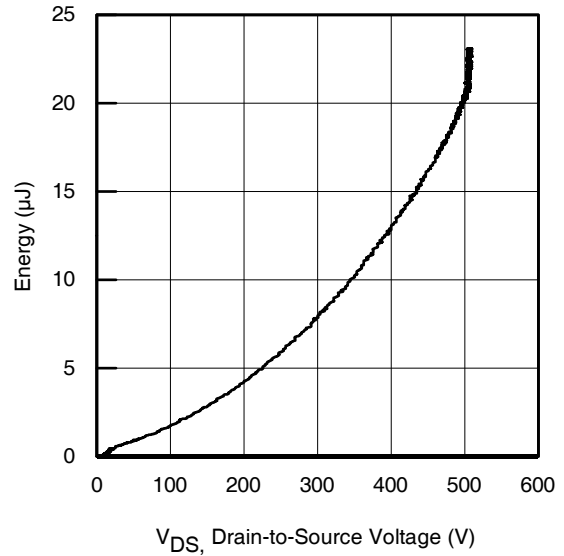


**Fig 4.** Normalized On-Resistance Vs. Temperature

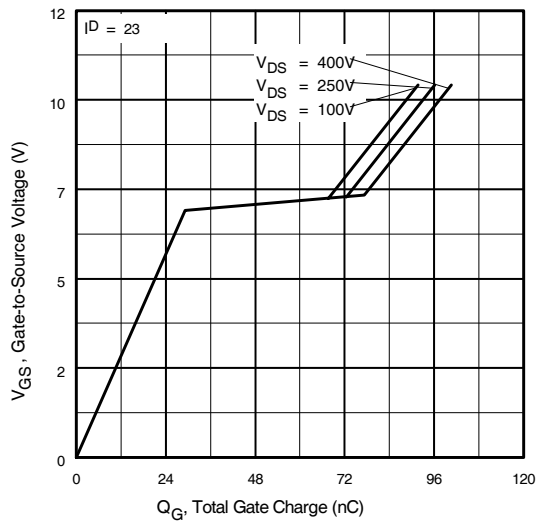
# IRFP23N50L



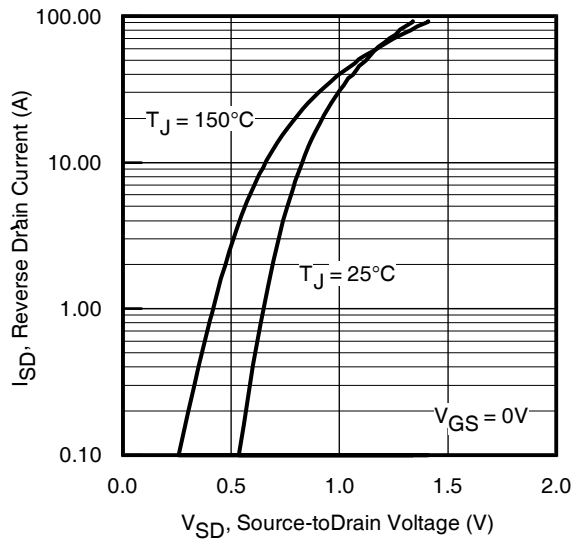
**Fig 5.** Typical Capacitance vs. Drain-to-Source Voltage



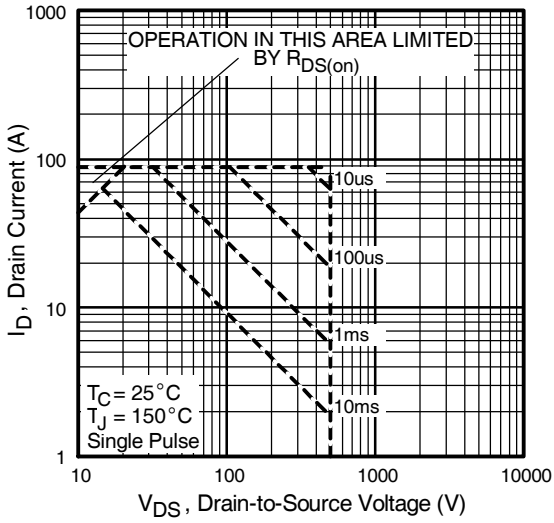
**Fig 6.** Typ. Output Capacitance Stored Energy vs.  $V_{DS}$



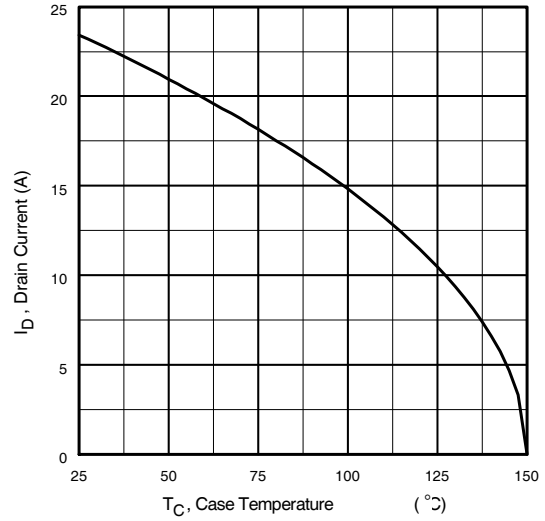
**Fig 7.** Typical Gate Charge vs. Gate-to-Source Voltage



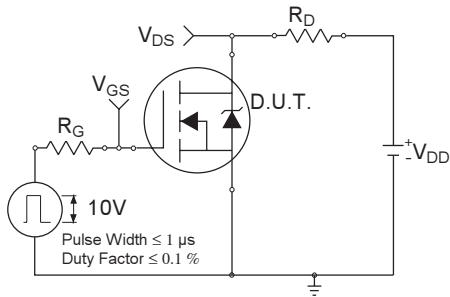
**Fig 8.** Typical Source-Drain Diode Forward Voltage



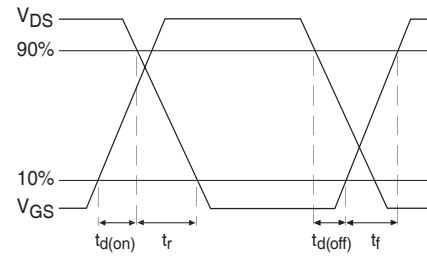
**Fig 9.** Maximum Safe Operating Area



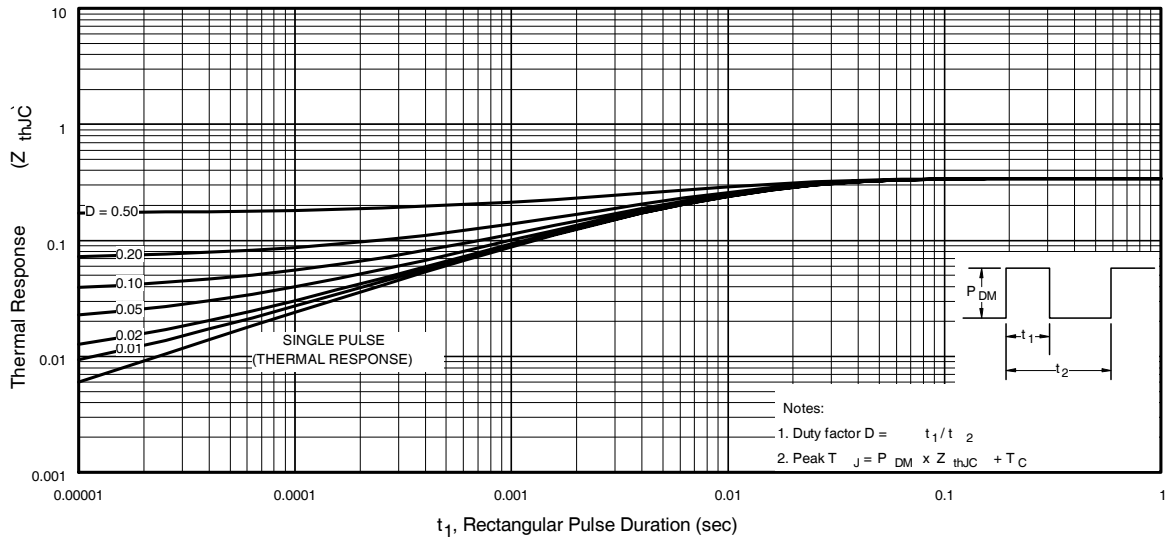
**Fig 10.** Maximum Drain Current vs. Case Temperature



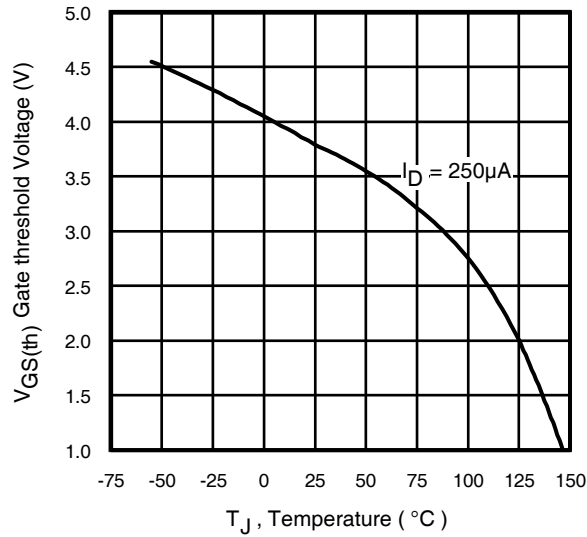
**Fig 11a.** Switching Time Test Circuit



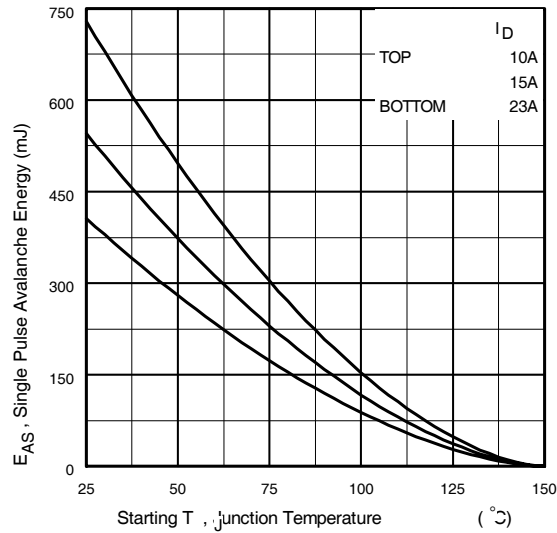
**Fig 11b.** Switching Time Waveforms



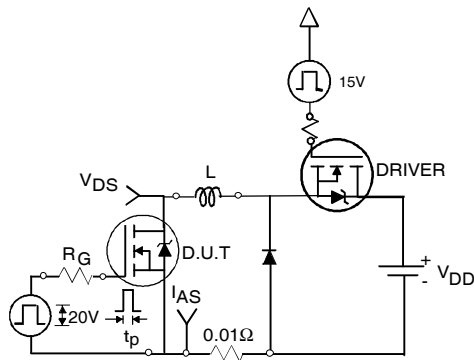
**Fig 12.** Maximum Effective Transient Thermal Impedance, Junction-to-Case



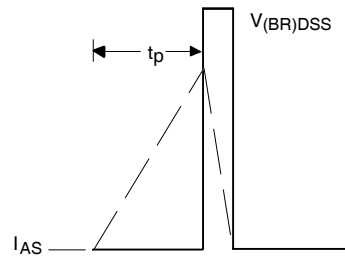
**Fig 13.** Threshold Voltage vs. Temperature



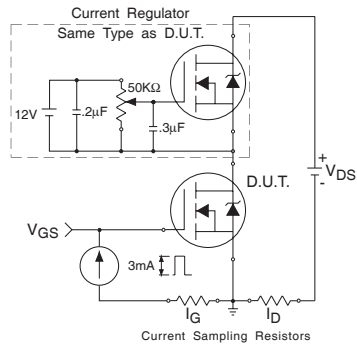
**Fig 14.** Maximum Avalanche Energy Vs. Drain Current



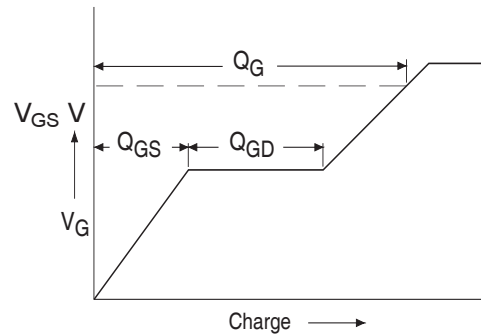
**Fig 15a.** Unclamped Inductive Test Circuit



**Fig 15b.** Unclamped Inductive Waveforms

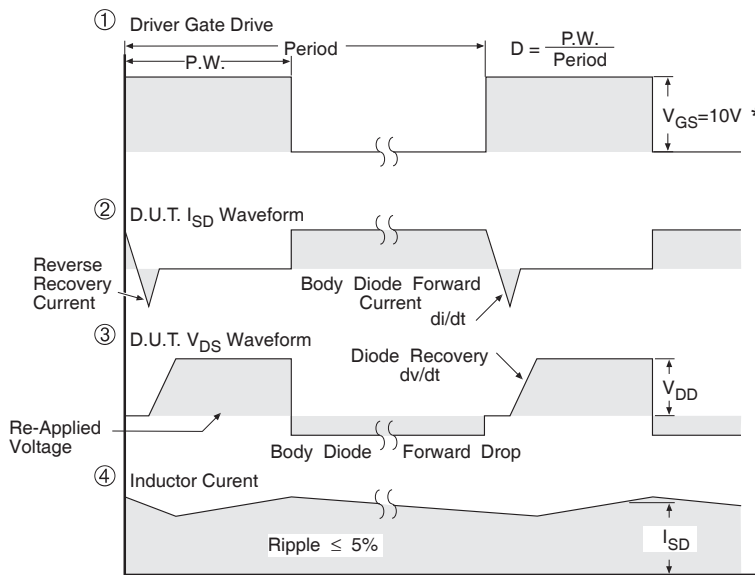
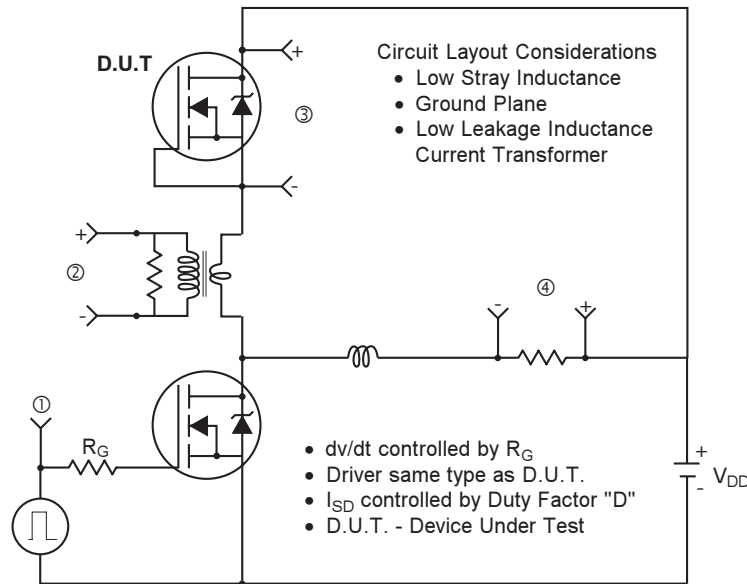


**Fig 16a.** Gate Charge Test Circuit



**Fig 16b.** Basic Gate Charge Waveform

## Peak Diode Recovery dv/dt Test Circuit



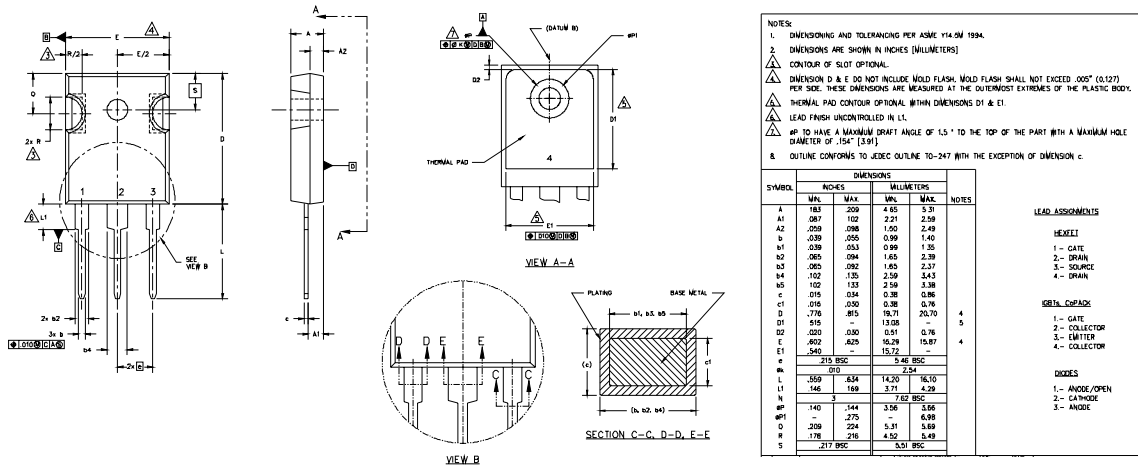
\*  $V_{GS} = 5V$  for Logic Level Devices

**Fig 17.** For N-Channel HEXFET® Power MOSFETs



## TO-247AC Package Outline

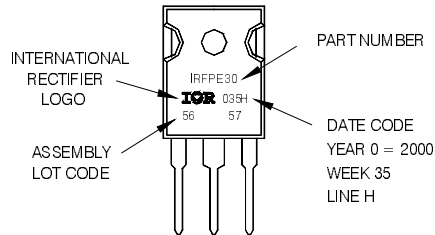
Dimensions are shown in millimeters (inches)



## TO-247AC Part Marking Information

EXAMPLE: THIS IS AN IRFPE30  
 WITH ASSEMBLY  
 LOT CODE 5657  
 ASSEMBLED ON WW 35, 2000  
 IN THE ASSEMBLY LINE 'H'

**Note:** "P" in assembly line position indicates "Lead-Free"



**TO-247AC package is not recommended for Surface Mount Application.**

Data and specifications subject to change without notice.  
 This product has been designed and qualified for the Industrial market.  
 Qualification Standards can be found on IR's Web site.



## Notice

The products described herein were acquired by Vishay Intertechnology, Inc., as part of its acquisition of International Rectifier's Power Control Systems (PCS) business, which closed in April 2007. Specifications of the products displayed herein are pending review by Vishay and are subject to the terms and conditions shown below.

Specifications of the products displayed herein are subject to change without notice. Vishay Intertechnology, Inc., or anyone on its behalf, assumes no responsibility or liability for any errors or inaccuracies.

Information contained herein is intended to provide a product description only. No license, express or implied, by estoppel or otherwise, to any intellectual property rights is granted by this document. Except as provided in Vishay's terms and conditions of sale for such products, Vishay assumes no liability whatsoever, and disclaims any express or implied warranty, relating to sale and/or use of Vishay products including liability or warranties relating to fitness for a particular purpose, merchantability, or infringement of any patent, copyright, or other intellectual property right.

The products shown herein are not designed for use in medical, life-saving, or life-sustaining applications. Customers using or selling these products for use in such applications do so at their own risk and agree to fully indemnify Vishay for any damages resulting from such improper use or sale.

International Rectifier®, IR®, the IR logo, HEXFET®, HEXSense®, HEXDIP®, DOL®, INTERO®, and POWIRTRAIN® are registered trademarks of International Rectifier Corporation in the U.S. and other countries. All other product names noted herein may be trademarks of their respective owners.