

High Voltage MOSFET

N-Channel Enhancement Mode
Avalanche Energy Rated

IXTA 1N80
IXTP 1N80
IXTY 1N80

$V_{DSS} = 800 \text{ V}$
 $I_{D25} = 750 \text{ mA}$
 $R_{DS(on)} = 11 \ \Omega$

Preliminary Data

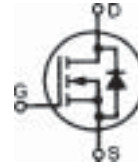

Symbol	Test Conditions	Maximum Ratings	
V_{DSS}	$T_J = 25^\circ\text{C}$ to 150°C	800	V
V_{DGR}	$T_J = 25^\circ\text{C}$ to 150°C ; $R_{GS} = 1 \text{ M}\Omega$	800	V
V_{GS}	Continuous	± 20	V
V_{GSM}	Transient	± 30	V
I_{D25}	$T_C = 25^\circ\text{C}$	750	mA
I_{DM}	$T_C = 25^\circ\text{C}$, pulse width limited by T_{JM}	3	A
I_{AR}		1.0	A
E_{AR}	$T_C = 25^\circ\text{C}$	5	mJ
E_{AS}	$T_C = 25^\circ\text{C}$	100	mJ
dv/dt	$I_S \leq I_{DM}$, $di/dt \leq 100 \text{ A}/\mu\text{s}$, $V_{DD} \leq V_{DSS}$, $T_J \leq 150^\circ\text{C}$, $R_G = 47 \ \Omega$	3	V/ns
P_D	$T_C = 25^\circ\text{C}$	40	W
T_J		-55 ... +150	$^\circ\text{C}$
T_{JM}		150	$^\circ\text{C}$
T_{stg}		-55 ... +150	$^\circ\text{C}$
M_d	Mounting torque	1.13/10	Nm/lb.in.
Weight	TO-220	4	g
	TO-252	0.8	g
	TO-263	3	g
Maximum lead temperature for soldering 1.6 mm (0.062 in.) from case for 10 s		300	$^\circ\text{C}$

TO-220AB (IXTP)

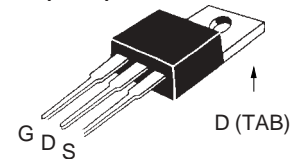

TO-263 AA (IXTA)

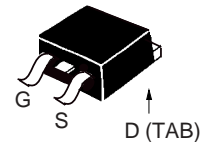

TO-252 AA (IXTY)

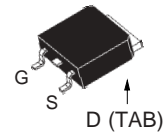

G = Gate, D = Drain,
S = Source, TAB = Drain

Features

- International standard packages
- High voltage, Low $R_{DS(on)}$ HDMOS™ process
- Rugged polysilicon gate cell structure
- Fast switching times

Applications

- Switch-mode and resonant-mode power supplies
- Flyback inverters
- DC choppers
- High frequency matching

Advantages

- Space savings
- High power density

Symbol	Test Conditions	Characteristic Values ($T_J = 25^\circ\text{C}$, unless otherwise specified)		
		min.	typ.	max.
V_{DSS}	$V_{GS} = 0 \text{ V}$, $I_D = 250 \ \mu\text{A}$	800		V
$V_{GS(th)}$	$V_{DS} = V_{GS}$, $I_D = 25 \ \mu\text{A}$	2.5		V
I_{GSS}	$V_{GS} = \pm 20 \text{ V}_{DC}$, $V_{DS} = 0$			$\pm 100 \text{ nA}$
I_{DSS}	$V_{DS} = V_{DSS}$, $V_{GS} = 0 \text{ V}$	$T_J = 25^\circ\text{C}$		25 μA
		$T_J = 125^\circ\text{C}$		500 μA
$R_{DS(on)}$	$V_{GS} = 10 \text{ V}$, $I_D = 500 \text{ mA}$ Pulse test, $t \leq 300 \ \mu\text{s}$, duty cycle $d \leq 2 \%$	9.5	11	Ω

Symbol	Test Conditions	Characteristic Values		
		$(T_J = 25^\circ\text{C}, \text{ unless otherwise specified})$		
		min.	typ.	max.
g_{fs}	$V_{DS} = 20\text{ V}; I_D = 500\text{ mA}, \text{ pulse test}$	0.7	0.8	S
C_{iss}	$V_{GS} = 0\text{ V}, V_{DS} = 25\text{ V}, f = 1\text{ MHz}$		220	pF
C_{oss}			23	pF
C_{rss}			4	pF
$t_{d(on)}$	$V_{GS} = 10\text{ V}, V_{DS} = 0.5 \cdot V_{DSS}, I_D = 1\text{ A}$ $R_G = 47\Omega, \text{ (External)}$		11	ns
t_r			19	ns
$t_{d(off)}$			40	ns
t_f			28	ns
$Q_{G(on)}$	$V_{GS} = 10\text{ V}, V_{DS} = 0.5 \cdot V_{DSS}, I_D = 1\text{ A}$		8.5	nC
Q_{GS}			2.5	nC
Q_{GD}			4.5	nC
R_{thJC}				3.1 K/W
R_{thCK}	(IXTP)		0.50	K/W

Symbol	Test Conditions	Characteristic Values		
		$(T_J = 25^\circ\text{C}, \text{ unless otherwise specified})$		
		min.	typ.	max.
I_S	$V_{GS} = 0\text{ V}$			750 mA
I_{SM}	Repetitive; pulse width limited by T_{JM}			3 A
V_{SD}	$I_F = I_S, V_{GS} = 0\text{ V},$ Pulse test, $t \leq 300\ \mu\text{s}, \text{ duty cycle } d \leq 2\%$		1.8	2 V
t_{rr}	$I_F = I_S, -di/dt = 100\text{ A}/\mu\text{s}, V_R = 100\text{ V}$		710	ns

TO-252 AA Outline

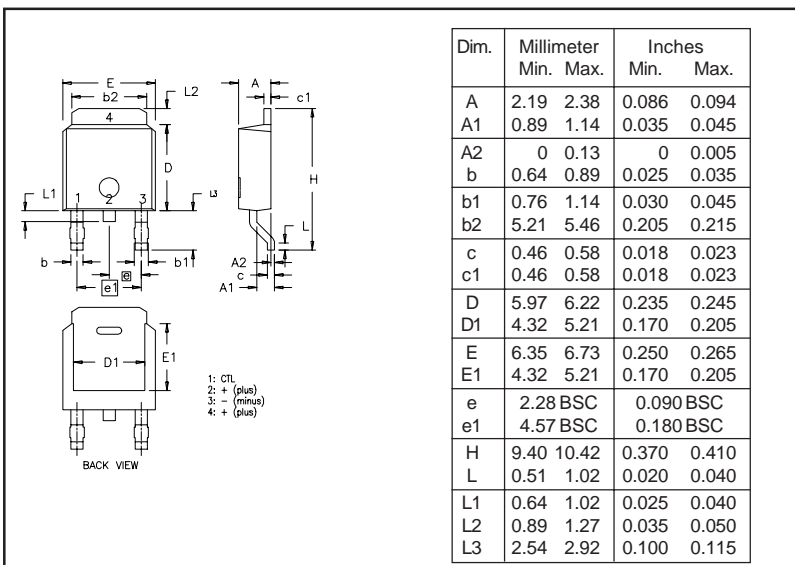

TO-220 AD Dimensions

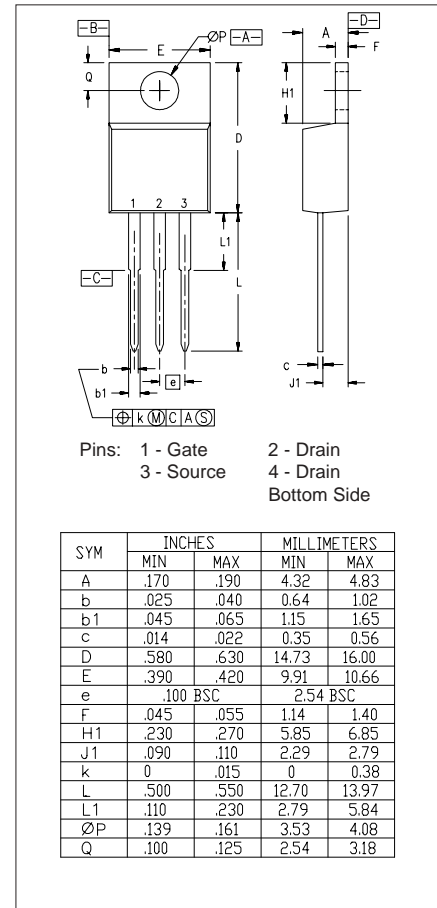

TO-263 AA Outline

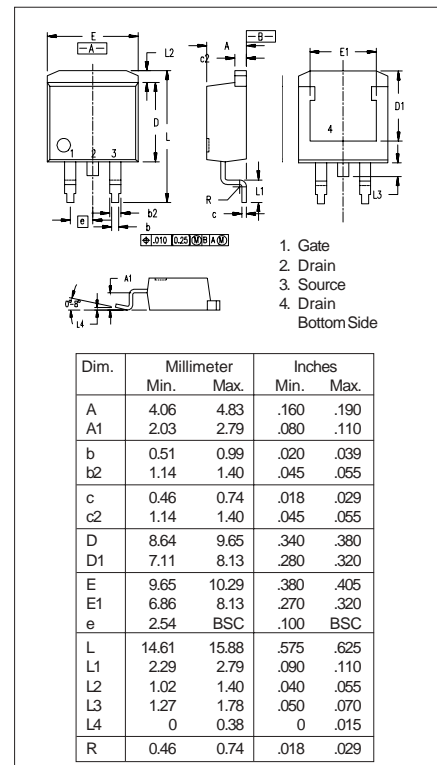

IXYS reserves the right to change limits, test conditions, and dimensions.