

Dual N-Channel 30-V (D-S) MOSFET

| PRODUCT SUMMARY | | | |
|---------------------|----------------------------------|---------------------------------|----------------------|
| V _{DS} (V) | r _{DS(on)} (Ω) | I _D (A) ^a | Q _g (Typ) |
| 30 | 0.225 at V _{GS} = 4.5 V | 1.3 ^a | 1.15 nC |
| | 0.345 at V _{GS} = 2.5 V | 1.3 ^a | |

FEATURES

- TrenchFET[®] Power MOSFET

APPLICATIONS

- Load switch for portable applications



RoHS
COMPLIANT

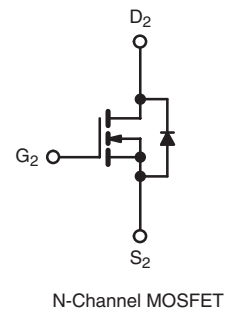
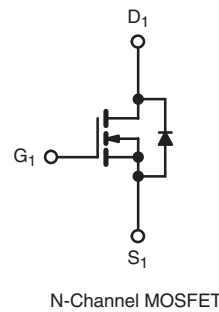
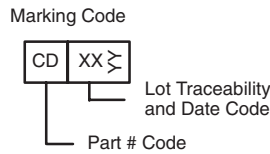
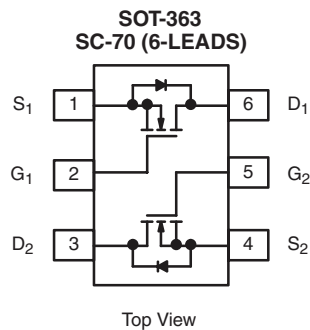

Ordering Information: Si1970DH-T1-E3 (Lead (Pb)-free)

| ABSOLUTE MAXIMUM RATINGS T _A = 25 °C, unless otherwise noted | | | | |
|---|-----------------------------------|------------------------|------|--|
| Parameter | Symbol | Limit | Unit | |
| Drain-Source Voltage | V _{DS} | 30 | V | |
| Gate-Source Voltage | V _{GS} | ± 12 | | |
| Continuous Drain Current (T _J = 150 °C) | I _D | T _C = 25 °C | A | |
| | | T _C = 70 °C | | |
| | | T _A = 25 °C | | |
| | | T _A = 70 °C | | |
| Pulsed Drain Current | I _{DM} | 4 | | |
| Continuous Source-Drain Diode Current | I _S | T _C = 25 °C | W | |
| | | T _A = 25 °C | | |
| Maximum Power Dissipation | P _D | T _C = 25 °C | W | |
| | | T _C = 70 °C | | |
| | | T _A = 25 °C | | |
| | | T _A = 70 °C | | |
| Operating Junction and Storage Temperature Range | T _J , T _{stg} | - 55 to 150 | °C | |
| Soldering Recommendations (Peak Temperature) ^{d, e} | | 260 | | |

THERMAL RESISTANCE RATINGS

| Parameter | Symbol | Typical | Maximum | Unit |
|---|-------------------|---------|---------|------|
| Maximum Junction-to-Ambient ^{b, f} | R _{thJA} | 130 | 170 | °C/W |
| Maximum Junction-to-Foot (Drain) | R _{thJF} | 80 | 100 | |

Notes:

a. Package limited.

b. Surface Mounted on 1" x 1" FR4 Board.

c. t = 5 sec.

d. Maximum under Steady State conditions is 220 °C/W.

| SPECIFICATIONS $T_J = 25\text{ }^\circ\text{C}$, unless otherwise noted | | | | | | |
|---|-------------------------|--|-----|-------|-----------|----------------------|
| Parameter | Symbol | Test Conditions | Min | Typ | Max | Unit |
| Static | | | | | | |
| Drain-Source Breakdown Voltage | V_{DS} | $V_{GS} = 0\text{ V}$, $I_D = 250\text{ }\mu\text{A}$ | 30 | | | V |
| V_{DS} Temperature Coefficient | $\Delta V_{DS}/T_J$ | $I_D = 250\text{ }\mu\text{A}$ | | 25 | | mV/ $^\circ\text{C}$ |
| $V_{GS(th)}$ Temperature Coefficient | $\Delta V_{GS(th)}/T_J$ | | | -3.2 | | |
| Gate-Source Threshold Voltage | $V_{GS(th)}$ | $V_{DS} = V_{GS}$, $I_D = 250\text{ }\mu\text{A}$ | 0.6 | | 1.6 | V |
| Gate-Source Leakage | I_{GSS} | $V_{DS} = 0\text{ V}$, $V_{GS} = \pm 12\text{ V}$ | | | ± 100 | ns |
| Zero Gate Voltage Drain Current | I_{DSS} | $V_{DS} = 30\text{ V}$, $V_{GS} = 0\text{ V}$ | | | 1 | μA |
| | | $V_{DS} = 30\text{ V}$, $V_{GS} = 0\text{ V}$, $T_J = 55\text{ }^\circ\text{C}$ | | | 10 | |
| On-State Drain Current ^a | $I_{D(on)}$ | $V_{DS} \leq 5\text{ V}$, $V_{GS} = 4.5\text{ V}$ | 4 | | | A |
| Drain-Source On-State Resistance ^a | $r_{DS(on)}$ | $V_{GS} = 4.5\text{ V}$, $I_D = 1.2\text{ A}$ | | 0.185 | 0.225 | Ω |
| | | $V_{GS} = 2.5\text{ V}$, $I_D = 0.29\text{ A}$ | | 0.285 | 0.345 | |
| Forward Transconductance ^a | g_{fs} | $V_{DS} = 15\text{ V}$, $I_D = 1.2\text{ A}$ | | 2.5 | | S |
| Dynamic^b | | | | | | |
| Input Capacitance | C_{iss} | $V_{DS} = 15\text{ V}$, $V_{GS} = 0\text{ V}$, $f = 1\text{ MHz}$ | | 95 | | μF |
| Output Capacitance | C_{oss} | | | 17 | | |
| Reverse Transfer Capacitance | C_{rss} | | | 9 | | |
| Total Gate Charge | Q_g | $V_{DS} = 15\text{ V}$, $V_{GS} = 10\text{ V}$, $I_D = 1.4\text{ A}$ | | 2.5 | 3.8 | nC |
| | | $V_{DS} = 10\text{ V}$, $V_{GS} = 4.5\text{ V}$, $I_D = 1.4\text{ A}$ | | 1.15 | 1.7 | |
| Gate-Source Charge | Q_{gs} | | | 0.4 | | |
| Gate-Drain Charge | Q_{gd} | | 0.3 | | | |
| Gate Resistance | R_g | $f = 1\text{ MHz}$ | | 4 | | Ω |
| Turn-On Delay Time | $t_{d(on)}$ | $V_{DD} = 15\text{ V}$, $R_L = 13.6\text{ }\Omega$ $I_D \cong 1.1\text{ A}$, $V_{GEN} = 4.5\text{ V}$, $R_g = 1\text{ }\Omega$ | | 9 | 15 | ns |
| Rise Time | t_r | | | 20 | 30 | |
| Turn-Off Delay Time | $t_{d(off)}$ | | | 15 | 25 | |
| Fall Time | t_f | | | 15 | 25 | |
| Turn-on Delay Time | $t_{d(on)}$ | $V_{DD} = 15\text{ V}$, $R_L = 13.6\text{ }\Omega$ $I_D \cong 1.1\text{ A}$, $V_{GEN} = 10\text{ V}$, $R_g = 1\text{ }\Omega$ | | 5 | 10 | |
| Rise Time | t_r | | | 10 | 15 | |
| Turn-Off Delay Time | $t_{d(off)}$ | | | 10 | 15 | |
| Fall Time | t_f | | | 6 | 12 | |
| Drain-Source Body Diode Characteristics | | | | | | |
| Continuous Source-Drain Diode Current | I_S | $T_C = 25\text{ }^\circ\text{C}$ | | | 1 | A |
| Pulse Diode Forward Current | I_{SM} | | | | 4 | |
| Body Diode Voltage | V_{SD} | $I_S = 1.1\text{ A}$, $V_{GS} = 0\text{ V}$ | | 0.85 | 1.2 | V |
| Body Diode Reverse Recovery Time | t_{rr} | $I_F = 1.1\text{ A}$, $di/dt = 100\text{ A}/\mu\text{s}$, $T_J = 25\text{ }^\circ\text{C}$ | | 20 | 40 | ns |
| Body Diode Reverse Recovery Charge | Q_{rr} | | | 10 | 20 | nC |
| Reverse Recovery Fall Time | t_a | | | 16.5 | | ns |
| Reverse Recovery Rise Time | t_b | | | 3.5 | | |

Notes:

- a. Pulse test; pulse width $\leq 300\text{ }\mu\text{s}$, duty cycle $\leq 2\%$.
b. Guaranteed by design, not subject to production testing.

Stresses beyond those listed under "Absolute Maximum Ratings" may cause permanent damage to the device. These are stress ratings only, and functional operation of the device at these or any other conditions beyond those indicated in the operational sections of the specifications is not implied. Exposure to absolute maximum rating conditions for extended periods may affect device reliability.

TYPICAL CHARACTERISTICS 25 °C, unless otherwise noted

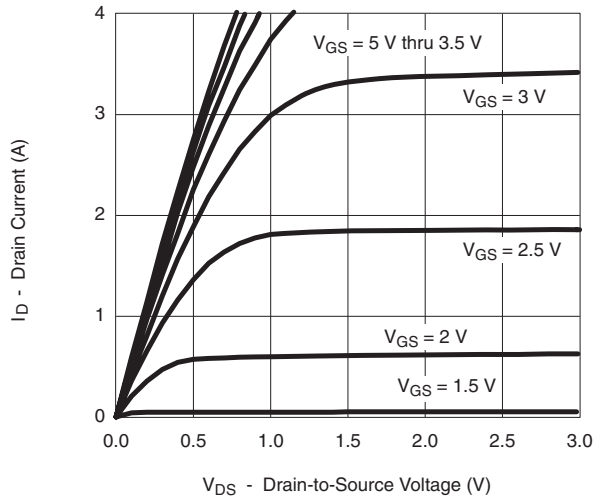

Output Characteristics

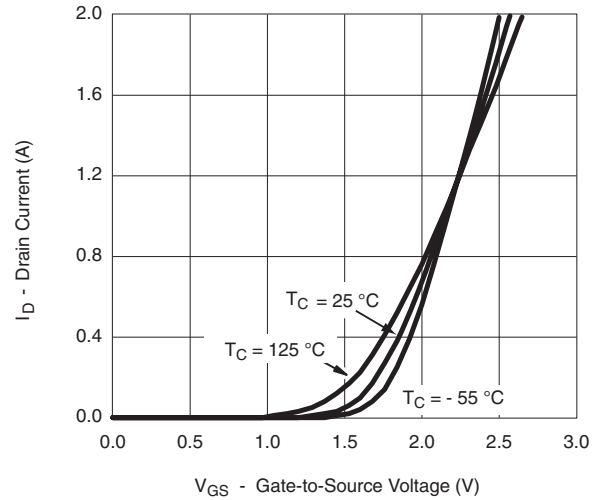

Transfer Characteristics

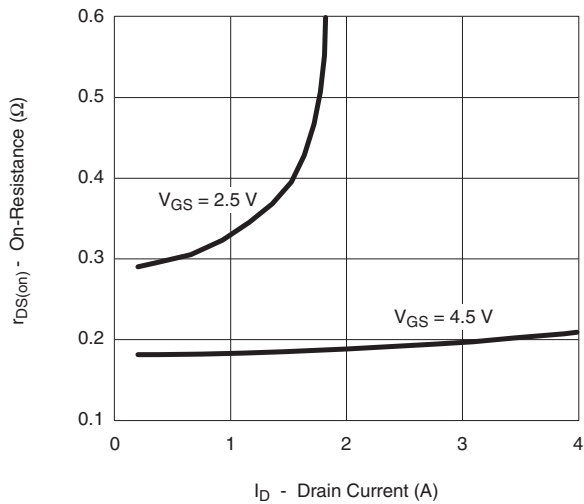

On-Resistance vs. Drain Current

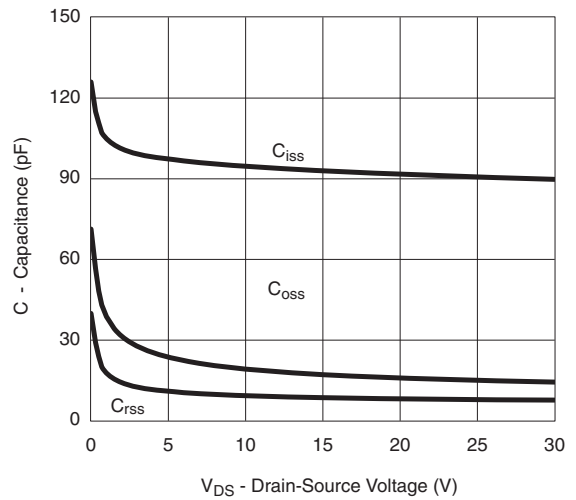

Capacitance

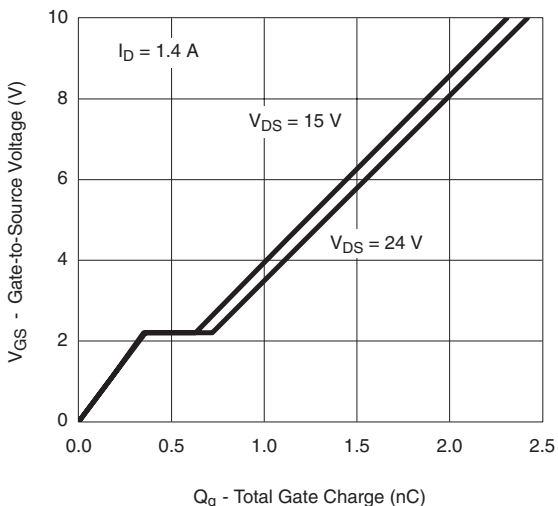

Gate Charge

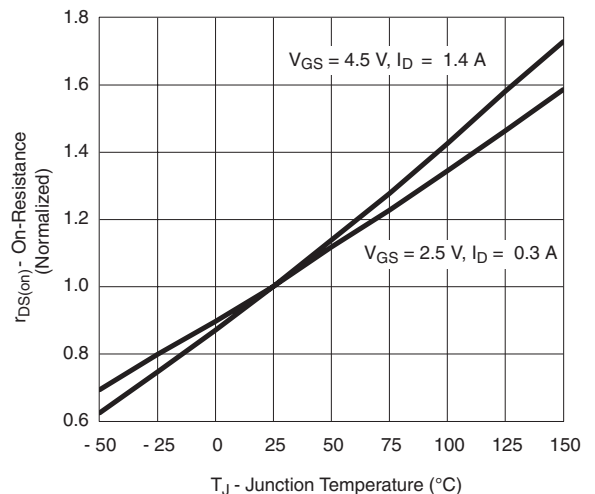

On-Resistance vs. Junction Temperature

TYPICAL CHARACTERISTICS 25 °C, unless otherwise noted

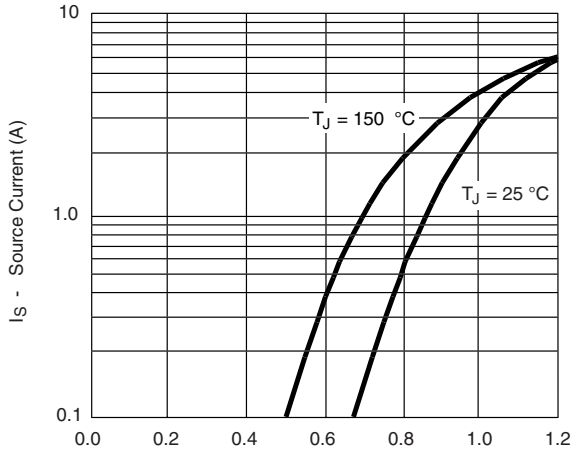

V_{SD} - Source-to-Drain Voltage (V)
Forward Diode Voltage

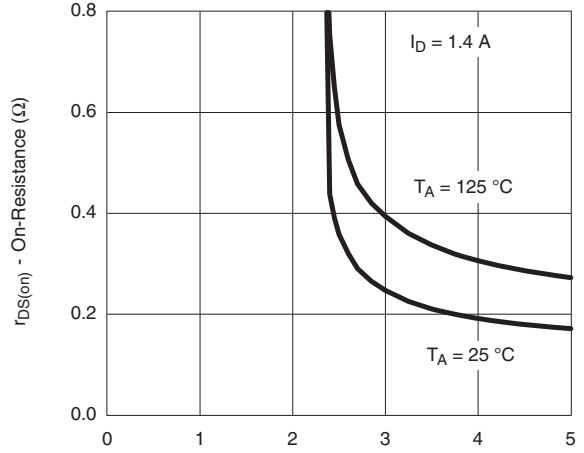

V_{GS} - Gate-to-Source Voltage (V)
On-Resistance vs. Gate-Source Voltage

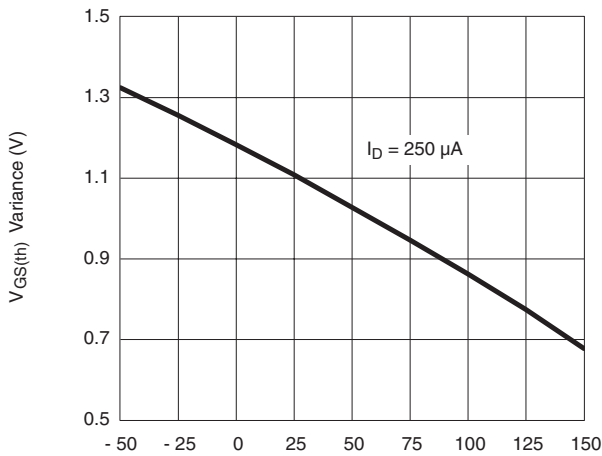

T_J - Temperature (°C)
Threshold Voltage

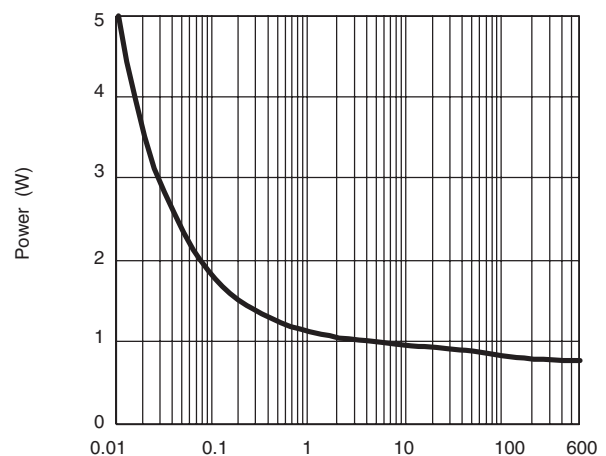

Single Pulse Power

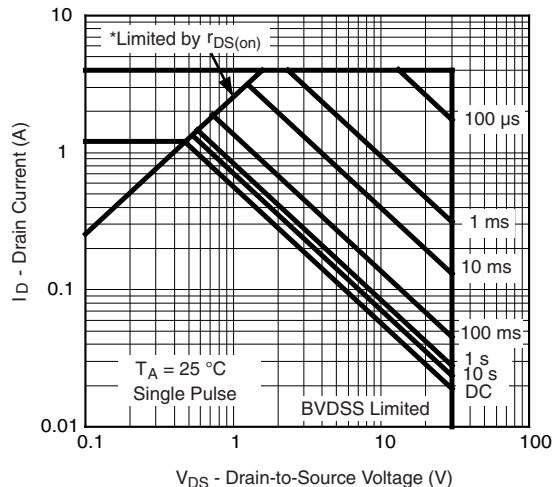

V_{DS} - Drain-to-Source Voltage (V)
* $V_{GS} >$ minimum V_{GS} at which $r_{DS(on)}$ is specified
Safe Operating Area, Junction-to-Ambient

TYPICAL CHARACTERISTICS 25 °C, unless otherwise noted

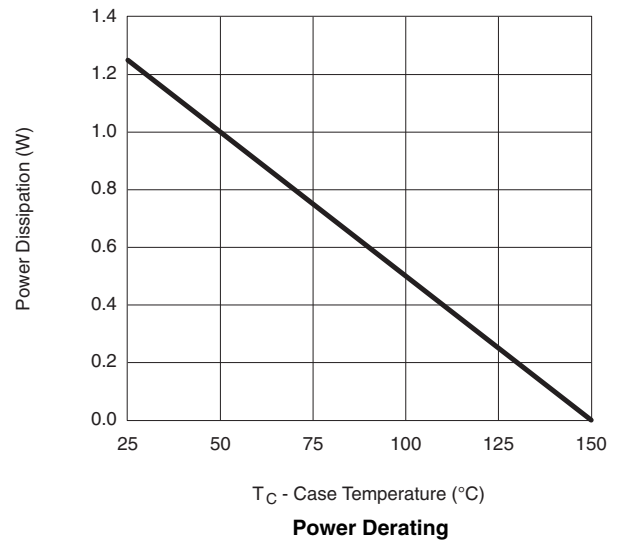
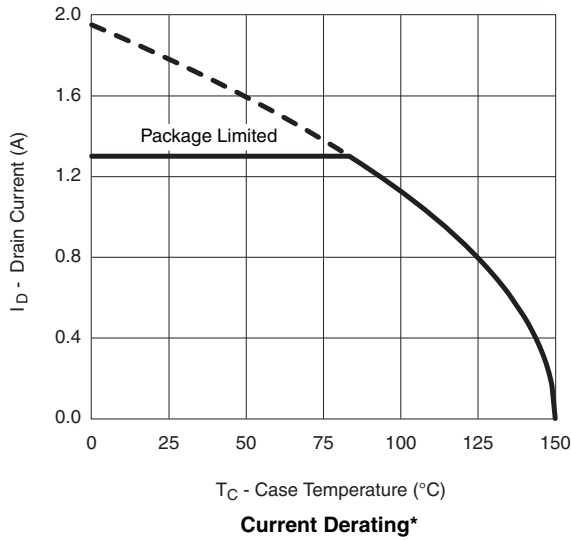

*The power dissipation P_D is based on $T_{J(max)} = 150\text{ °C}$, using junction-to-case thermal resistance, and is more useful in settling the upper dissipation limit for cases where additional heatsinking is used. It is used to determine the current rating, when this rating falls below the package limit.

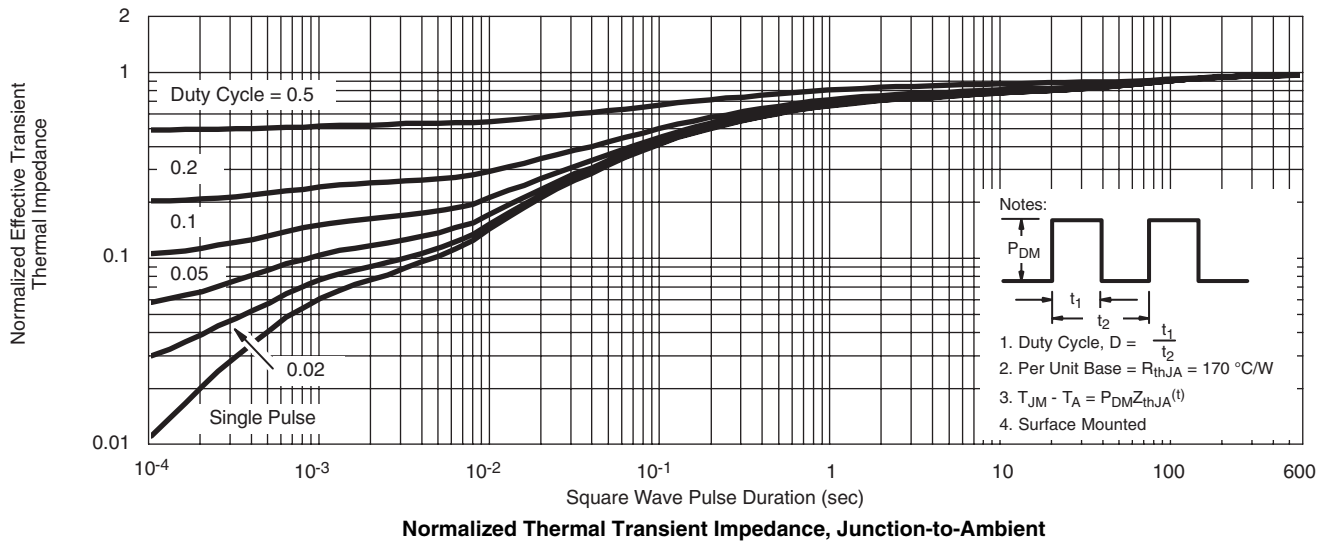

TYPICAL CHARACTERISTICS 25 °C, unless otherwise noted

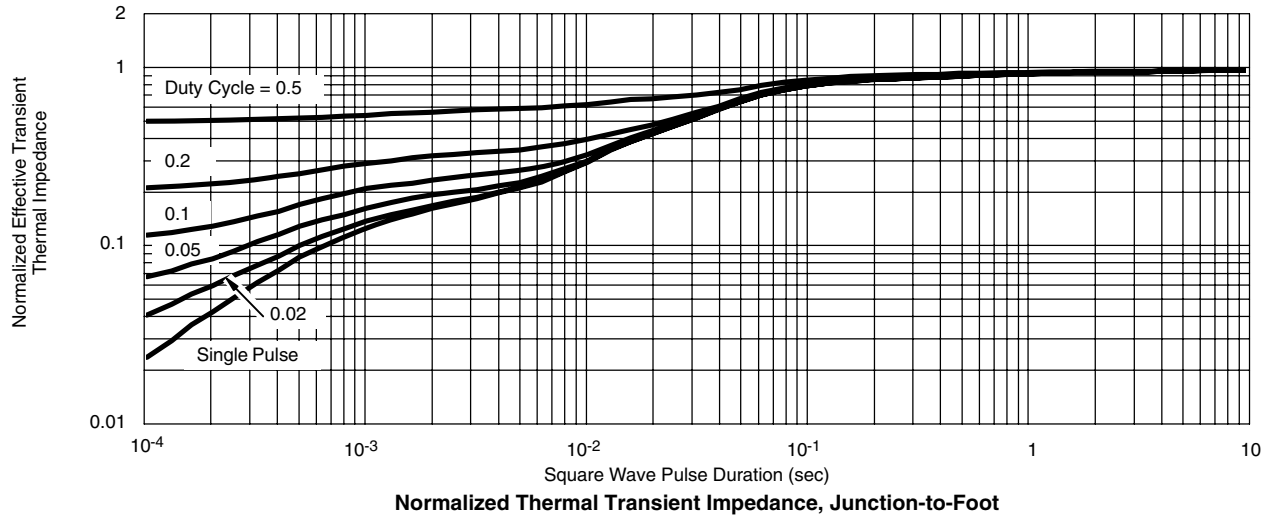

Vishay Siliconix maintains worldwide manufacturing capability. Products may be manufactured at one of several qualified locations. Reliability data for Silicon Technology and Package Reliability represent a composite of all qualified locations. For related documents such as package/tape drawings, part marking, and reliability data, see <http://www.vishay.com/ppg?74343>.



Notice

Specifications of the products displayed herein are subject to change without notice. Vishay Intertechnology, Inc., or anyone on its behalf, assumes no responsibility or liability for any errors or inaccuracies.

Information contained herein is intended to provide a product description only. No license, express or implied, by estoppel or otherwise, to any intellectual property rights is granted by this document. Except as provided in Vishay's terms and conditions of sale for such products, Vishay assumes no liability whatsoever, and disclaims any express or implied warranty, relating to sale and/or use of Vishay products including liability or warranties relating to fitness for a particular purpose, merchantability, or infringement of any patent, copyright, or other intellectual property right.

The products shown herein are not designed for use in medical, life-saving, or life-sustaining applications. Customers using or selling these products for use in such applications do so at their own risk and agree to fully indemnify Vishay for any damages resulting from such improper use or sale.