

Single P-Channel 20-V (D-S) MOSFET With Schottky Diode

MOSFET PRODUCT SUMMARY		
V_{DS} (V)	$r_{DS(on)}$ (Ω)	I_D (A)
- 20	0.048 at $V_{GS} = -4.5$ V	- 6.3
	0.068 at $V_{GS} = -2.5$ V	- 5.3
	0.090 at $V_{GS} = -1.8$ V	- 4.6

SCHOTTKY PRODUCT SUMMARY		
V_{KA} (V)	V_f (V) Diode Forward Voltage	I_F (A)
20	0.48 V at 0.5 A	1.0

FEATURES

- TrenchFET® Power MOSFETS: 1.8–V Rated
- ESD Protected: 4500 V
- Ultra-Low Thermal Resistance, PowerPAK® Package with Low 1.07-mm Profile



RoHS*
COMPLIANT

APPLICATIONS

- Charger Switching

PowerPAK 1212-8

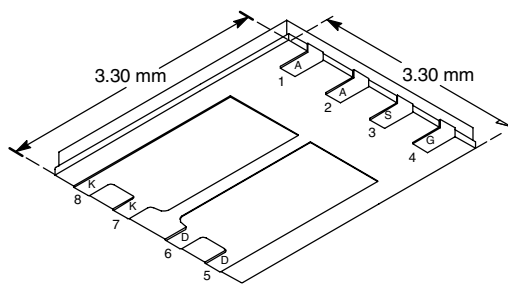

Bottom View

Ordering Information: Si7703EDN-T1
Si7703EDN-T1-E3 (Lead (Pb)-free)

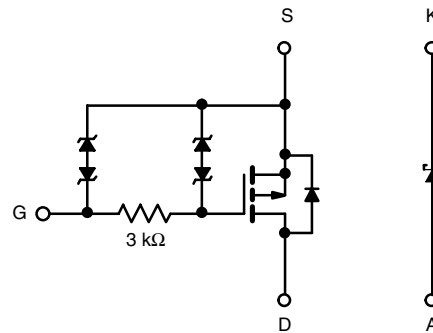

P-Channel MOSFET

ABSOLUTE MAXIMUM RATINGS $T_A = 25\text{ }^\circ\text{C}$, unless otherwise noted				
Parameter	Symbol	10 secs	Steady State	Unit
Drain-Source Voltage (MOSFET and Schottky)	V_{DS}	- 20		V
Reverse Voltage (Schottky)	V_{KA}	20		
Gate-Source Voltage (MOSFET)	V_{GS}	± 12	± 12	A
Continuous Drain Current ($T_J = 150\text{ }^\circ\text{C}$) (MOSFET) ^a	I_D	$T_A = 25\text{ }^\circ\text{C}$	- 6.3	
		$T_A = 85\text{ }^\circ\text{C}$	- 4.5	
Pulsed Drain Current (MOSFET)	I_{DM}	- 20		
Continuous Source Current (MOSFET Diode Conduction) ^a	I_S	- 2.3	- 1.1	
Average Forward Current (Schottky)	I_F	1.0		
Pulsed Forward Current (Schottky)	I_{FM}	7		W
Maximum Power Dissipation (MOSFET) ^a	P_D	$T_A = 25\text{ }^\circ\text{C}$	2.8	
		$T_A = 85\text{ }^\circ\text{C}$	1.5	
Maximum Power Dissipation (Schottky) ^a	P_D	$T_A = 25\text{ }^\circ\text{C}$	2.0	
		$T_A = 85\text{ }^\circ\text{C}$	1.0	
Operating Junction and Storage Temperature Range	T_J, T_{stg}	- 55 to 150		$^\circ\text{C}$
Soldering Recommendations ^{b,c}		260		

Notes

- Surface Mounted on 1" x 1" FR4 Board.
 - See Solder Profile (<http://www.vishay.com/ppg?73257>). The PowerPAK 1212-8 is a leadless package. The end of the lead terminal is exposed copper (not plated) as a result of the singulation process in manufacturing. A solder fillet at the exposed copper tip cannot be guaranteed and is not required to ensure adequate bottom side solder interconnection.
 - Rework Conditions: manual soldering with a soldering iron is not recommended for leadless components.
- * Pb containing terminations are not RoHS compliant, exemptions may apply

THERMAL RESISTANCE RATINGS

Parameter		Device	Symbol	Typical	Maximum	Unit
Junction-to-Ambient ^a	t ≤ 10 sec	MOSFET	R _{thJA}	35	44	°C/W
		Schottky		51	64	
	Steady State	MOSFET		75	94	
		Schottky		91	115	
Junction-to-Case (Drain)	Steady State	MOSFET	R _{thJC}	4	5	
		Schottky		10	12	

Notes

a. Surface Mounted on 1" x 1" FR4 Board.

MOSFET SPECIFICATIONS T_J = 25 °C, unless otherwise noted

Parameter	Symbol	Test Condition	Min	Typ	Max	Unit
Static						
Gate Threshold Voltage	V _{GS(th)}	V _{DS} = V _{GS} , I _D = - 800 μA	- 0.45		- 1.0	V
Gate-Body Leakage	I _{GSS}	V _{DS} = 0 V, V _{GS} = ± 4.5 V			± 1.5	μA
		V _{DS} = 0 V, V _{GS} = ± 12 V			± 100	mA
Zero Gate Voltage Drain Current	I _{DSS}	V _{DS} = - 20 V, V _{GS} = 0 V			- 1	μA
		V _{DS} = - 20 V, V _{GS} = 0 V, T _J = 85 °C			- 5	
On-State Drain Current ^a	I _{D(on)}	V _{DS} ≤ - 5 V, V _{GS} = - 4.5 V	- 20			A
Drain-Source On-State Resistance ^a	r _{DS(on)}	V _{GS} = - 4.5 V, I _D = - 6.3 A		0.041	0.048	Ω
		V _{GS} = - 2.5 V, I _D = - 5.3 A		0.057	0.068	
		V _{GS} = - 1.8 V, I _D = - 1 A		0.072	0.090	
Forward Transconductance ^a	g _{fs}	V _{DS} = - 10 V, I _D = - 6.3 A		14		S
Diode Forward Voltage ^a	V _{SD}	I _S = - 2.3 A, V _{GS} = 0 V		- 0.8	- 1.2	V
Dynamic^b						
Total Gate Charge	Q _g	V _{DS} = - 10 V, V _{GS} = - 4.5 V, I _D = - 6.3 A		12	18	nC
Gate-Source Charge	Q _{gs}			2.5		
Gate-Drain Charge	Q _{gd}			2.9		
Turn-On Delay Time	t _{d(on)}	V _{DD} = - 10 V, R _L = 10 Ω I _D = - 1 A, V _{GEN} = - 4.5 V, R _G = 6 Ω		2.5	4	vS
Rise Time	t _r			4	6	
Turn-Off Delay Time	t _{d(off)}			15	23	
Fall Time	t _f			12	18	

Notes

a. Pulse test; pulse width ≤ 300 μs, duty cycle ≤ 2 %.

b. Guaranteed by design, not subject to production testing.

SCHOTTKY SPECIFICATIONS T_J = 25 °C, unless otherwise noted

Parameter	Symbol	Test Condition	Min	Typ	Max	Unit
Forward Voltage Drop	V _F	I _F = 0.5 A		0.42	0.48	V
		I _F = 0.5 A, T _J = 125 °C		0.33	0.4	
Maximum Reverse Leakage Current	I _{rm}	V _r = 20 V		0.002	0.100	mA
		V _r = 20 V, T _J = 85 °C		0.10	1	
		V _r = 20 V, T _J = 125 °C		1.5	10	
Junction Capacitance	C _T	V _r = 10 V		31		pF

Stresses beyond those listed under "Absolute Maximum Ratings" may cause permanent damage to the device. These are stress ratings only, and functional operation of the device at these or any other conditions beyond those indicated in the operational sections of the specifications is not implied. Exposure to absolute maximum rating conditions for extended periods may affect device reliability.



MOSFET TYPICAL CHARACTERISTICS $T_A = 25\text{ }^\circ\text{C}$, unless otherwise noted

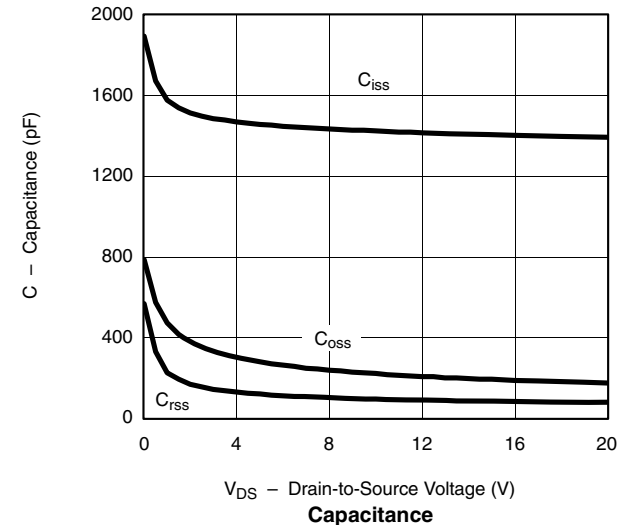
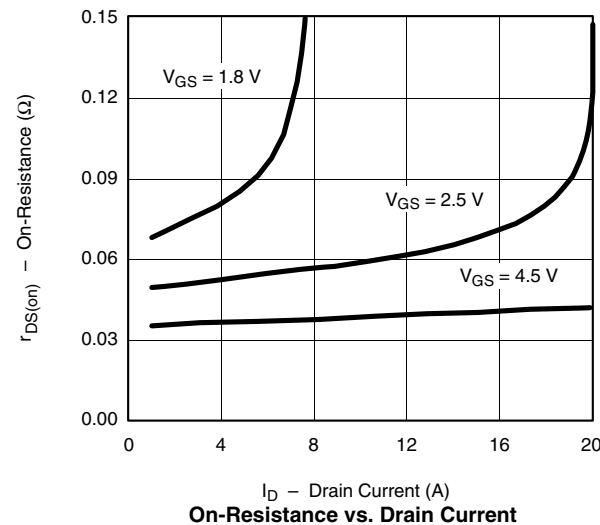
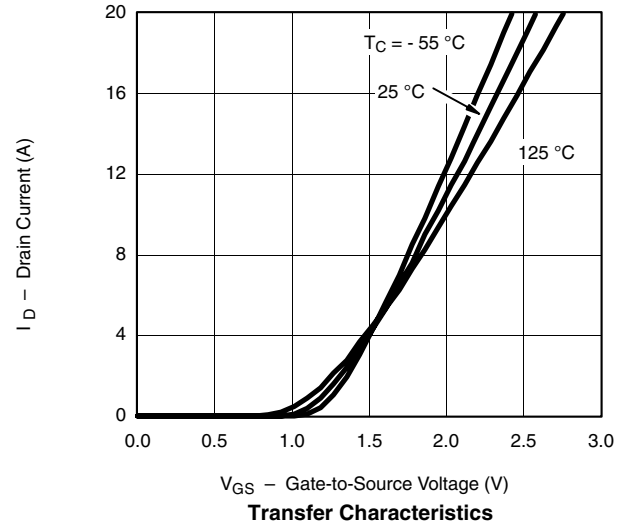
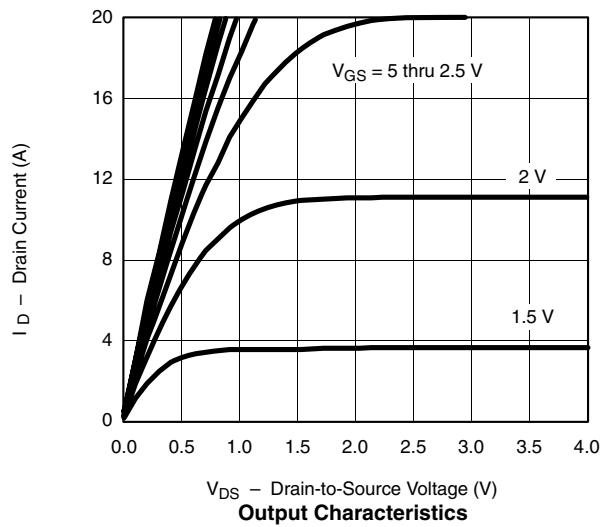
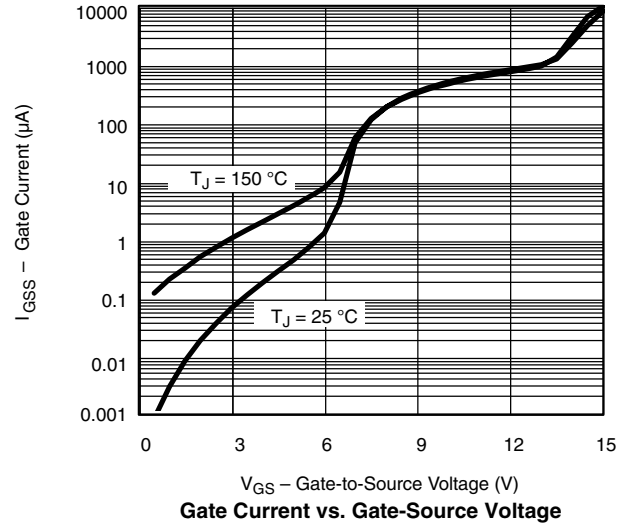
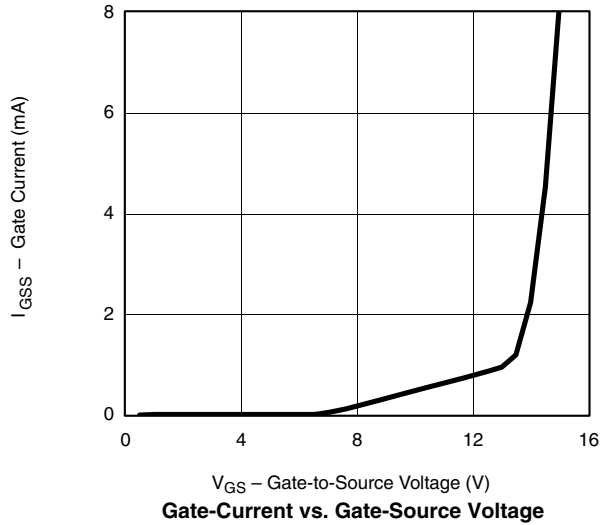



MOSFET TYPICAL CHARACTERISTICS $T_A = 25\text{ }^\circ\text{C}$, unless otherwise noted

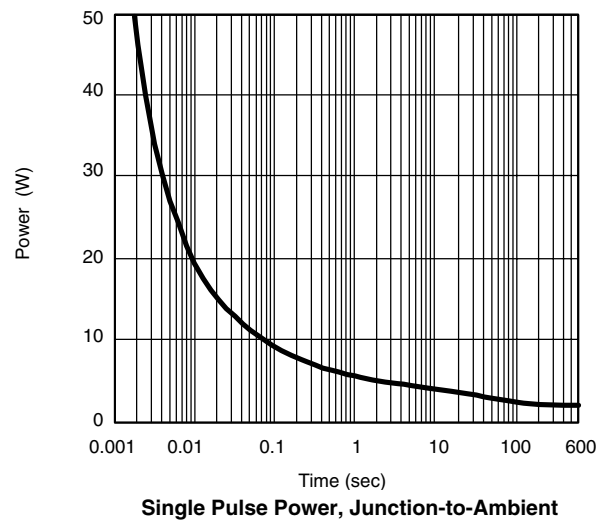
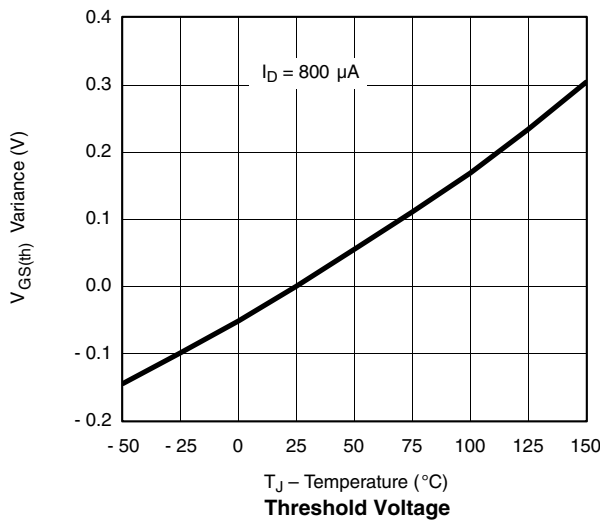
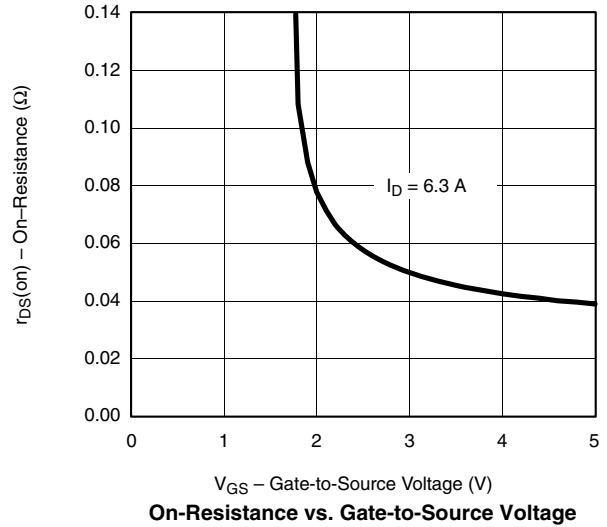
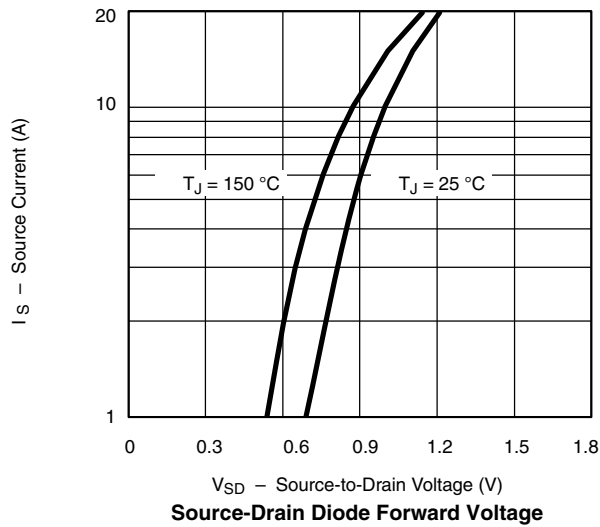
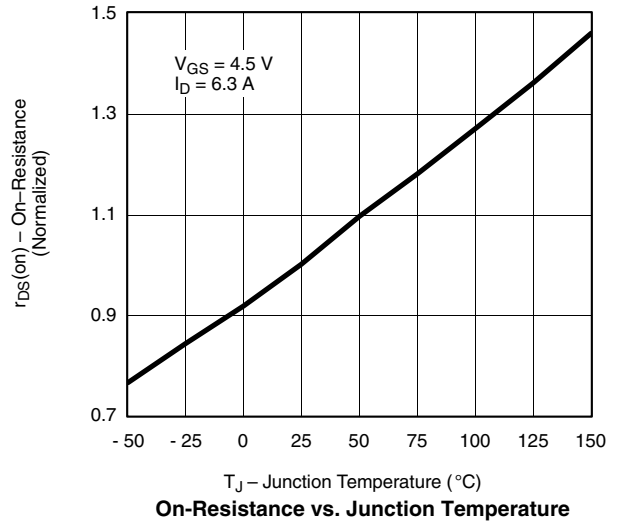
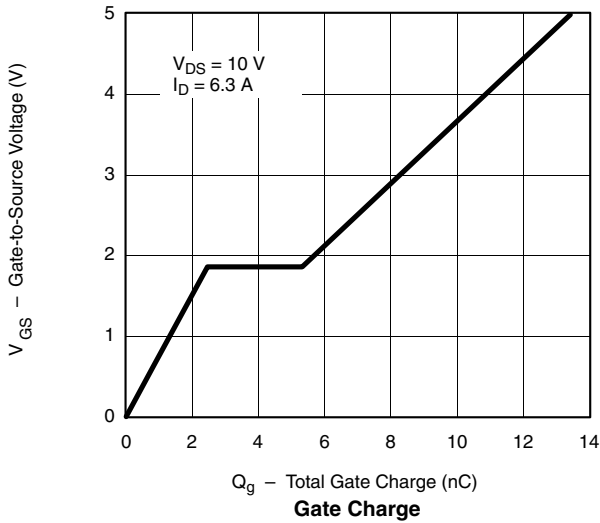

MOSFET TYPICAL CHARACTERISTICS $T_A = 25\text{ }^\circ\text{C}$, unless otherwise noted

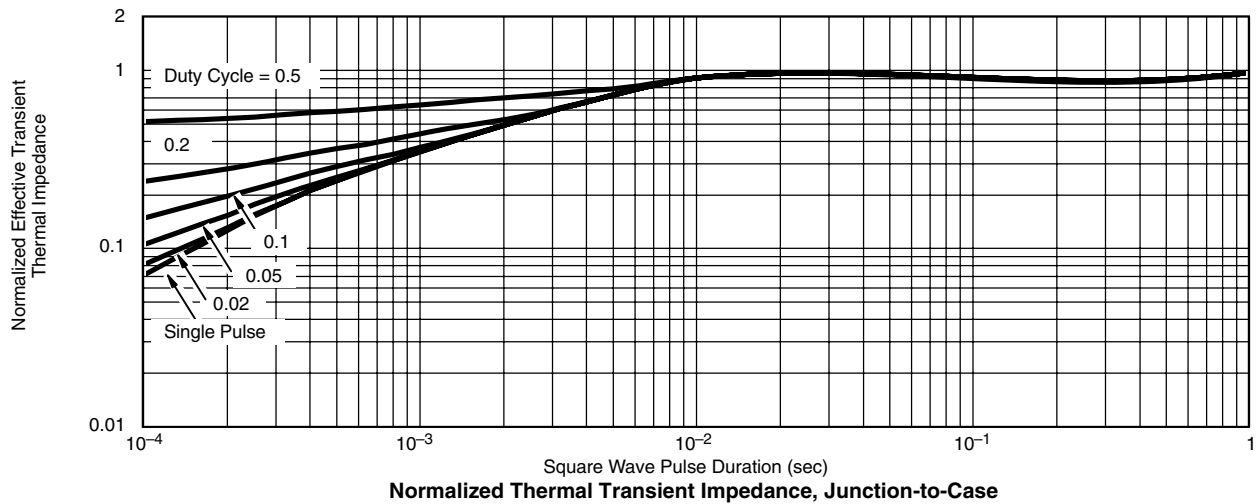
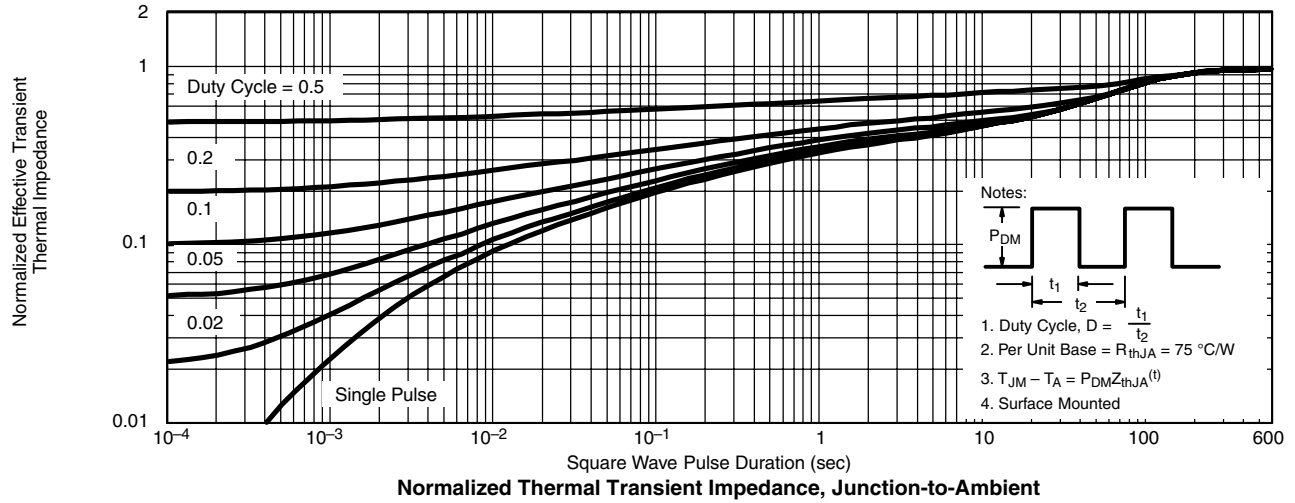

SCHOTTKY TYPICAL CHARACTERISTICS $T_A = 25\text{ }^\circ\text{C}$, unless otherwise noted

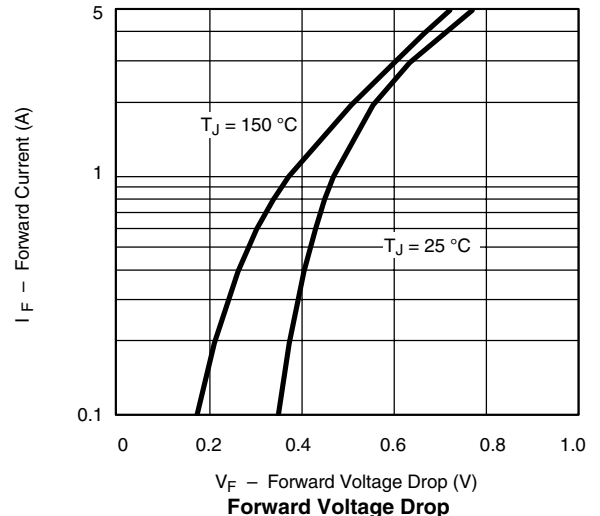
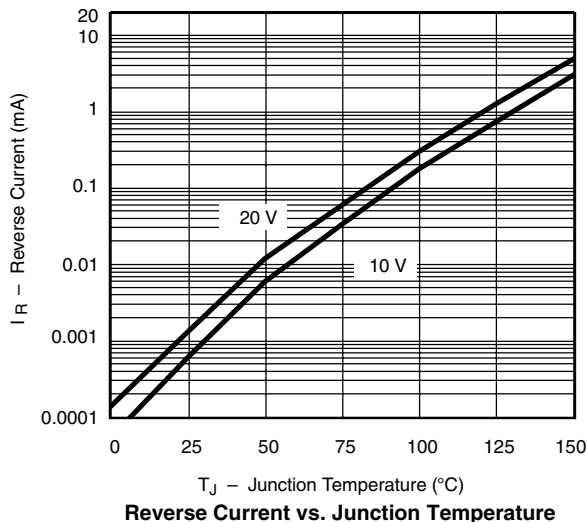



SCHOTTKY TYPICAL CHARACTERISTICS $T_A = 25\text{ }^\circ\text{C}$, unless otherwise noted

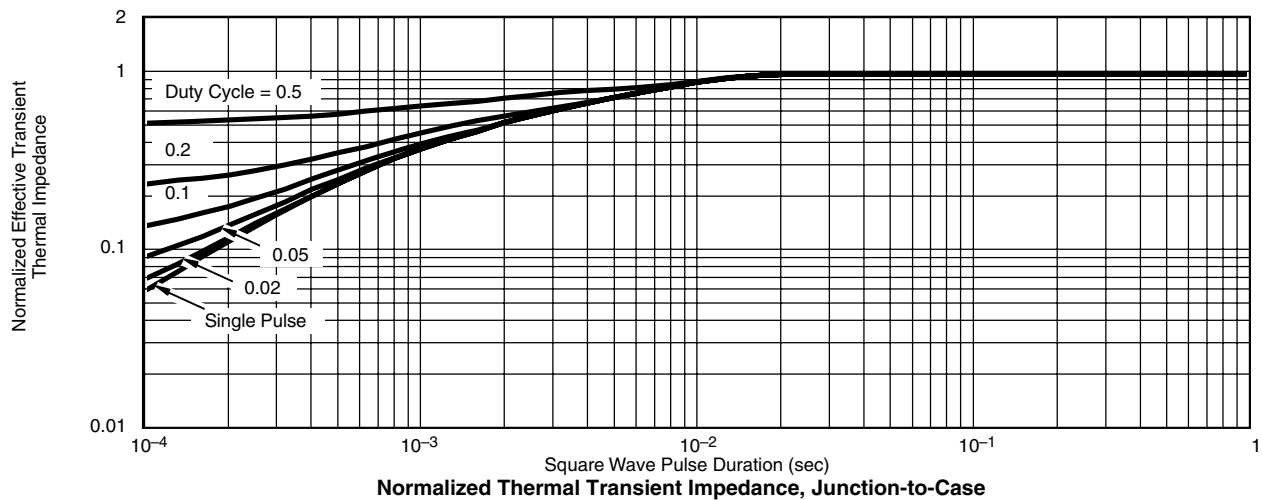
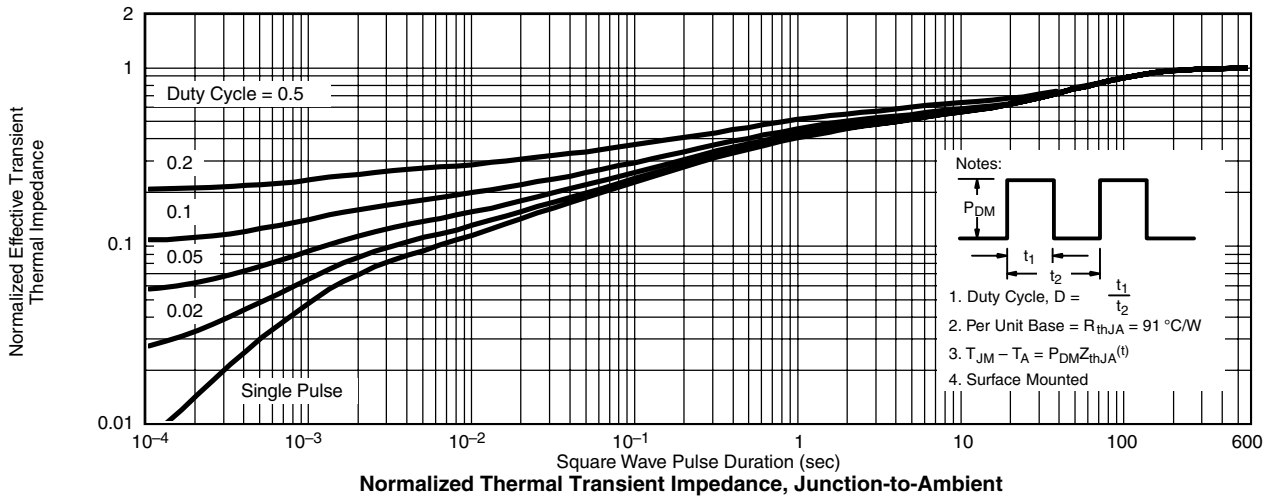
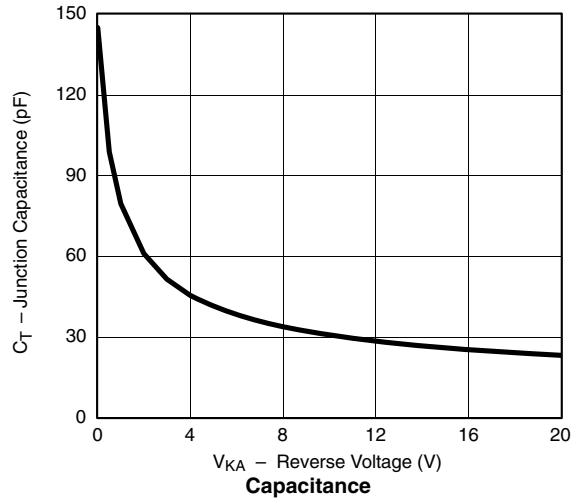

Vishay Siliconix maintains worldwide manufacturing capability. Products may be manufactured at one of several qualified locations. Reliability data for Silicon Technology and Package Reliability represent a composite of all qualified locations. For related documents such as package/tape drawings, part marking, and reliability data, see <http://www.vishay.com/ppg?71429>.



Notice

Specifications of the products displayed herein are subject to change without notice. Vishay Intertechnology, Inc., or anyone on its behalf, assumes no responsibility or liability for any errors or inaccuracies.

Information contained herein is intended to provide a product description only. No license, express or implied, by estoppel or otherwise, to any intellectual property rights is granted by this document. Except as provided in Vishay's terms and conditions of sale for such products, Vishay assumes no liability whatsoever, and disclaims any express or implied warranty, relating to sale and/or use of Vishay products including liability or warranties relating to fitness for a particular purpose, merchantability, or infringement of any patent, copyright, or other intellectual property right.

The products shown herein are not designed for use in medical, life-saving, or life-sustaining applications. Customers using or selling these products for use in such applications do so at their own risk and agree to fully indemnify Vishay for any damages resulting from such improper use or sale.