



STGF3NC120HD

N-CHANNEL 3A - 1200V TO-220FP

FAST PowerMESH™ IGBT with Integral Damper Diode

Table 1: General Features

TYPE	V _{CES}	V _{CE(sat)} (Max) @25°C	I _C @100°C
STGF3NC120HD	1200 V	< 2.8 V	3 A

- LOW ON-VOLTAGE DROP (V_{cesat})
- HIGH CURRENT CAPABILITY
- OFF LOSSES INCLUDE TAIL CURRENT
- HIGH SPEED

DESCRIPTION

This PowerMESH™ IGBT is designed using the latest high voltage technology based on a patented strip layout. A new lifetime control allows good switching performance and low voltage drop. This IGBT featuring a co-packaged diode is optimized for horizontal deflection applications in small and medium sets.

APPLICATIONS

- HORIZONTAL DEFLECTION
- HOME APPLIANCE
- LIGHTING

Table 2: Order Code

PART NUMBER	MARKING	PACKAGE	PACKAGING
STGF3NC120HD	GF3NC120HD	TO-220FP	TUBE

Figure 1: Package

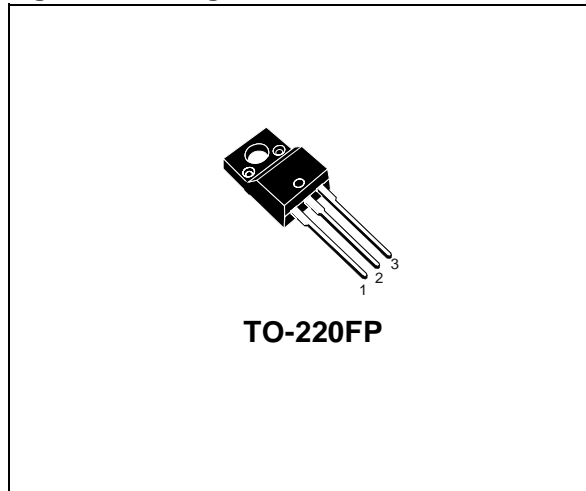

Figure 2: Internal Schematic Diagram

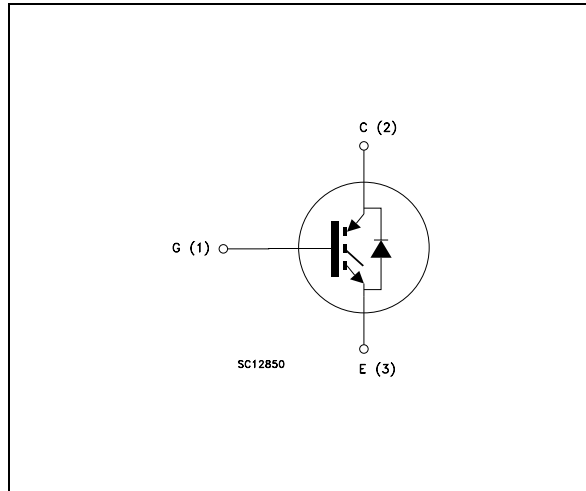

Table 3: Absolute Maximum ratings

Symbol	Parameter	Value	Unit
V_{CES}	Collector-Emitter Voltage ($V_{GS} = 0$)	1200	V
V_{ECR}	Emitter-Collector Voltage	20	V
V_{GE}	Gate-Emitter Voltage	± 20	V
I_C	Collector Current (continuous) at $T_C = 25^\circ\text{C}$	6	A
I_C	Collector Current (continuous) at $T_C = 100^\circ\text{C}$	3	A
I_{CM} (■)	Collector Current (pulsed)	10	A
P_{TOT}	Total Dissipation at $T_C = 25^\circ\text{C}$	25	W
	Derating Factor	0.20	W/ $^\circ\text{C}$
V_{ISO}	Insulation withstand voltage AC ($t=1\text{sec}$, $T_c=25^\circ\text{C}$)	2500	V
T_{stg}	Storage Temperature	-55 to 150	$^\circ\text{C}$
T_j	Operating Junction Temperature range		

(■) Pulse width limited by safe operating area

Table 4: Thermal Data

		Min.	Typ.	Max.	
$R_{thj-case}$	Thermal Resistance Junction-case			5.0	$^\circ\text{C}/\text{W}$
$R_{thj-amb}$	Thermal Resistance Junction-ambient			62.5	$^\circ\text{C}/\text{W}$
T_L	Maximum Lead Temperature for Soldering Purpose (1.6 mm from case, for 10 sec.)		300		$^\circ\text{C}$

ELECTRICAL CHARACTERISTICS ($T_{CASE} = 25^\circ\text{C}$ UNLESS OTHERWISE SPECIFIED)**Table 5: On/Off**

Symbol	Parameter	Test Conditions	Min.	Typ.	Max.	Unit
$V_{BR(CES)}$	Collector-Emitter Breakdown Voltage	$I_C = 1\text{ mA}$, $V_{GE} = 0$	1200			V
I_{CES}	Collector cut-off Current ($V_{GE} = 0$)	$V_{CE} = \text{Max Rating}$, $T_C = 25^\circ\text{C}$ $V_{CE} = \text{Max Rating}$, $T_C = 125^\circ\text{C}$			50 1	μA mA
I_{GES}	Gate-Emitter Leakage Current ($V_{CE} = 0$)	$V_{GE} = \pm 20\text{V}$, $V_{CE} = 0$			± 100	nA
$V_{GE(th)}$	Gate Threshold Voltage	$V_{CE} = V_{GE}$, $I_C = 250\ \mu\text{A}$	2		5	V
$V_{CE(sat)}$	Collector-Emitter Saturation Voltage	$V_{GE} = 15\text{V}$, $I_C = 3\text{ A}$ $V_{GE} = 15\text{V}$, $I_C = 3\text{ A}$, $T_c = 125^\circ\text{C}$		2.3 2.2	2.8	V V

ELECTRICAL CHARACTERISTICS (CONTINUED)

Table 6: Dynamic

Symbol	Parameter	Test Conditions	Min.	Typ.	Max.	Unit
g_{fs} (1)	Forward Transconductance	$V_{CE} = 25 \text{ V}$, $I_C = 3 \text{ A}$		4		S
C_{ies}	Input Capacitance	$V_{CE} = 25 \text{ V}$, $f = 1 \text{ MHz}$, $V_{GE} = 0$		470		pF
C_{oes}	Output Capacitance			45		pF
C_{res}	Reverse Transfer Capacitance			6		pF
Q_g Q_{ge} Q_{gc}	Total Gate Charge Gate-Emitter Charge Gate-Collector Charge	$V_{CC} = 960 \text{ V}$, $I_C = 3 \text{ A}$, $V_{GE} = 15 \text{ V}$ (see Figure 22)		24 3 10	32	nC nC nC
I_{CL}	Turn-off SOA minimum current	$V_{clamp} = 960 \text{ V}$, $T_j = 150^\circ\text{C}$ $R_G = 10 \Omega$, $V_{GE} = 15 \text{ V}$	10			A

(1) Pulsed: Pulse duration= 300 μs , duty cycle 1.5%

Table 7: Switching On

Symbol	Parameter	Test Conditions	Min.	Typ.	Max.	Unit	
$t_{d(on)}$ t_r $(di/dt)_{on}$	Turn-on Delay Time Current Rise Time Turn-on Current Slope	$V_{CC} = 800 \text{ V}$, $I_C = 3 \text{ A}$ $R_G = 10 \Omega$, $V_{GE} = 15 \text{ V}$, $T_j = 25^\circ\text{C}$ (see Figure 20)		15 3.5 880		ns ns A/ μs	
$t_{d(on)}$ t_r $(di/dt)_{on}$	Turn-on Delay Time Current Rise Time Turn-on Current Slope		$V_{CC} = 480 \text{ V}$, $I_C = 3 \text{ A}$ $R_G = 10 \Omega$, $V_{GE} = 15 \text{ V}$, $T_j = 125^\circ\text{C}$ (see Figure 20)		14.5 4 770		ns ns A/ μs

Table 8: Switching Off

Symbol	Parameter	Test Conditions	Min.	Typ.	Max.	Unit	
$t_r(V_{off})$ $t_{d(off)}$ t_f	Off Voltage Rise Time Turn-off Delay Time Current Fall Time	$V_{CC} = 800 \text{ V}$, $I_C = 3 \text{ A}$, $R_G = 10 \Omega$, $V_{GE} = 15 \text{ V}$ $T_j = 25^\circ\text{C}$ (see Figure 20)		72 118 250		ns ns ns	
$t_r(V_{off})$ $t_{d(off)}$ t_f	Off Voltage Rise Time Turn-off Delay Time Current Fall Time		$V_{CC} = 800 \text{ V}$, $I_C = 3 \text{ A}$, $R_G = 10 \Omega$, $V_{GE} = 15 \text{ V}$ $T_j = 125^\circ\text{C}$ (see Figure 20)		132 210 470		ns ns ns

Table 9: Switching Energy

Symbol	Parameter	Test Conditions	Min.	Typ.	Max.	Unit	
E_{on} (2) E_{off} (3) E_{ts}	Turn-on Switching Losses Turn-off Switching Loss Total Switching Loss	$V_{CC} = 800 \text{ V}$, $I_C = 3 \text{ A}$ $R_G = 10 \Omega$, $V_{GE} = 15 \text{ V}$, $T_j = 25^\circ\text{C}$ (see Figure 21)		236 290 526		μJ μJ μJ	
E_{on} (2) E_{off} (3) E_{ts}	Turn-on Switching Losses Turn-off Switching Loss Total Switching Loss		$V_{CC} = 800 \text{ V}$, $I_C = 3 \text{ A}$ $R_G = 10 \Omega$, $V_{GE} = 15 \text{ V}$, $T_j = 125^\circ\text{C}$ (see Figure 21)		360 620 980		μJ μJ μJ

(2) E_{on} is the turn-on losses when a typical diode is used in the test circuit in figure 2. If the IGBT is offered in a package with a co-pack diode, the co-pack diode is used as external diode. IGBTs & DIODE are at the same temperature (25°C and 125°C)

(3) Turn-off losses include also the tail of the collector current.

Table 10: Collector-Emitter Diode

Symbol	Parameter	Test Conditions	Min.	Typ.	Max	Unit
I_f I_{fm}	Forward Current Forward Current pulsed				3 12	A A
V_f	Forward On-Voltage	$I_f = 1.5\text{ A}$ $I_f = 1.5\text{ A}, T_j = 125^\circ\text{C}$		1.6 1.3	2.0	V V
t_{rr} Q_{rr} I_{rm}	Reverse Recovery Time Reverse Recovery Charge Reverse Recovery Current	$I_f = 3\text{ A}, V_R = 40\text{ V}$ $T_j = 25^\circ\text{C}, di/dt = 100\text{ A}/\mu\text{s}$ (see Figure 23)		51 85 3.3		ns nC A
t_{rr} Q_{rr} I_{rm}	Reverse Recovery Time Reverse Recovery Charge Reverse Recovery Current	$I_f = 3\text{ A}, V_R = 40\text{ V}$ $T_j = 125^\circ\text{C}, di/dt = 100\text{ A}/\mu\text{s}$ (see Figure 23)		64 133 4.2		ns nC A

Figure 3: Output Characteristics

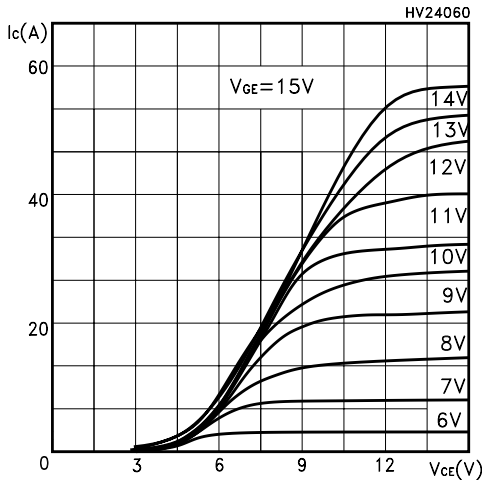

Figure 4: Transconductance

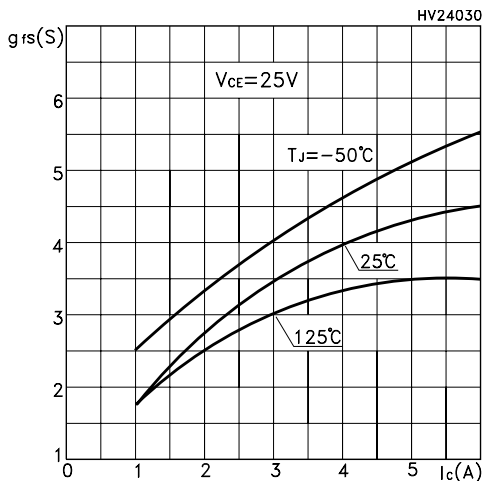

Figure 5: Collector-Emitter On Voltage vs Collector Current

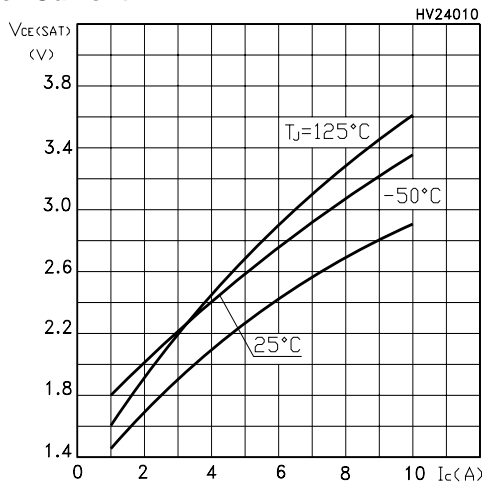

Figure 6: Transfer Characteristics

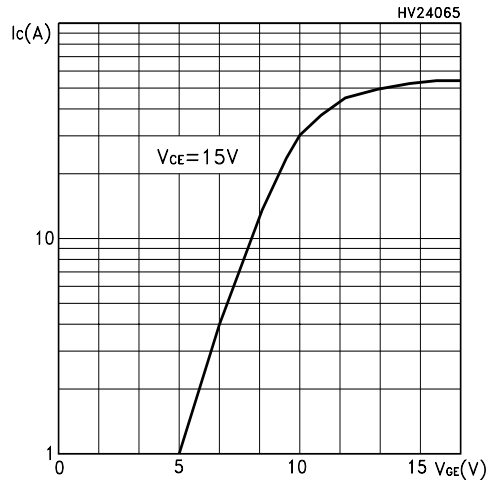

Figure 7: Collector-Emitter On Voltage vs Temperature

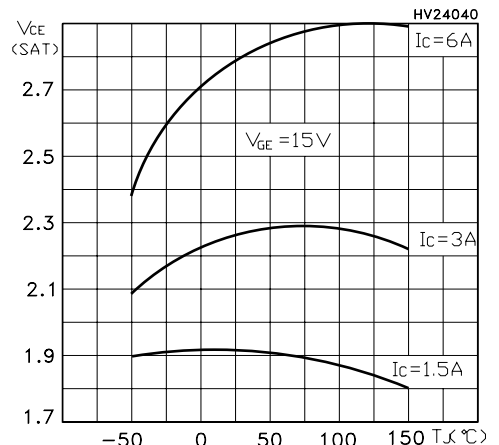

Figure 8: Normalized Gate Threshold vs Temperature

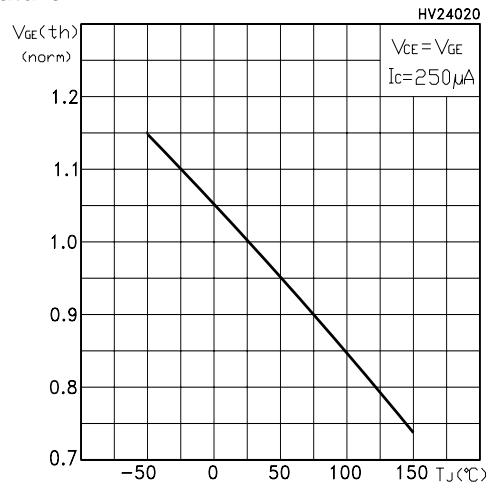

Figure 9: Normalized Breakdown Voltage vs Temperature

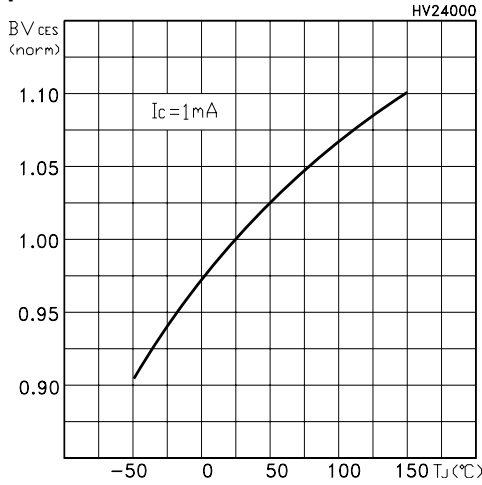

Figure 10: Capacitance Variations

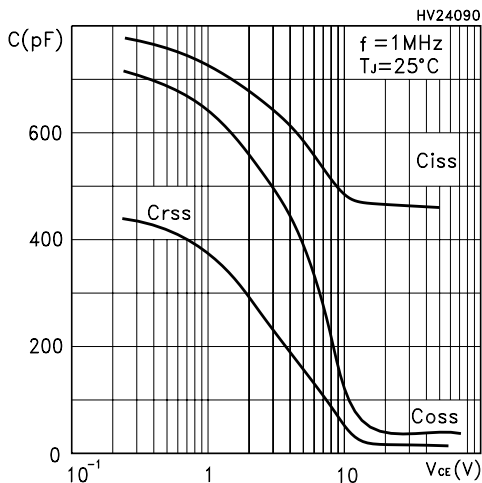

Figure 11: Switching Losses vs Gate Resistance

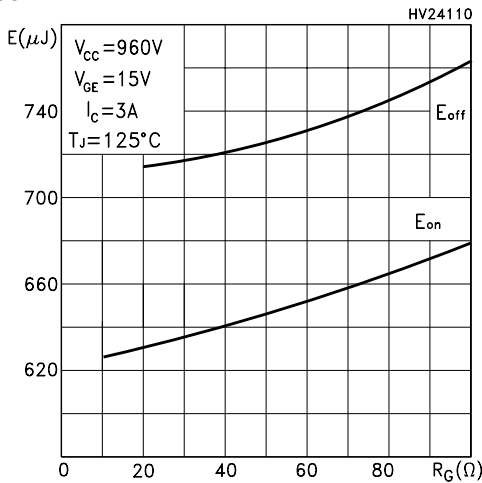

Figure 12: Gate Charge vs Gate-Emitter Voltage

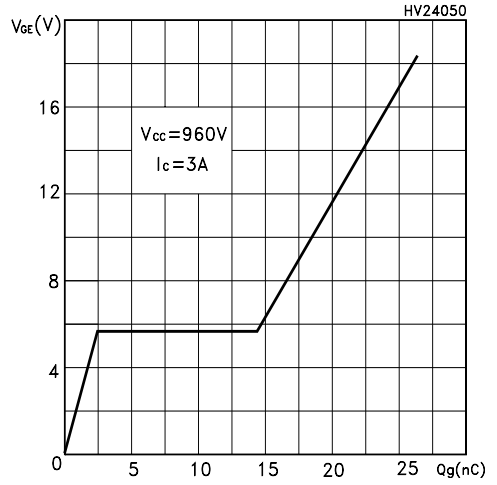

Figure 13: Switching Losses vs Temperature

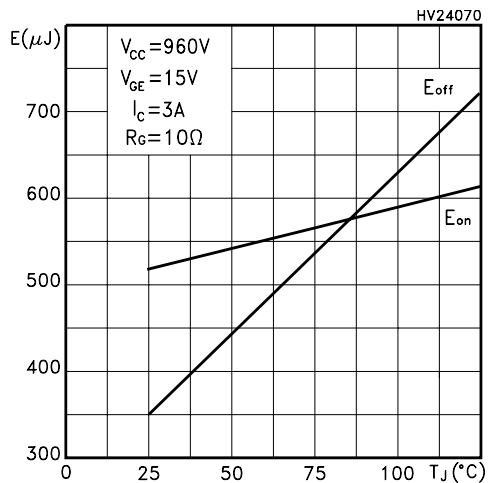

Figure 14: Switching Losses vs Collector Current

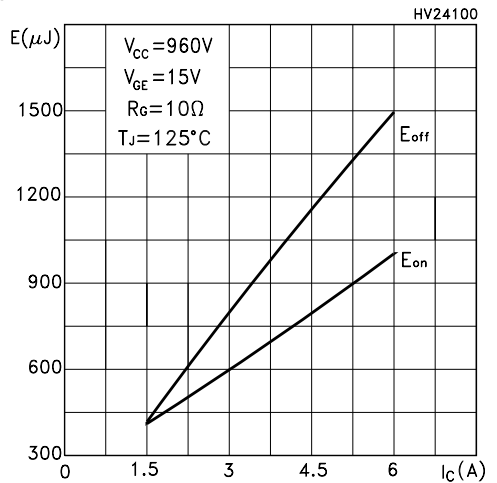

Figure 15: Thermal Impedance

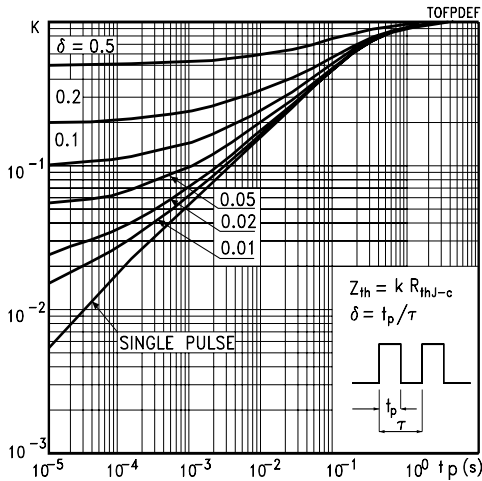

Figure 16: Collector-Emitter Diode Characteristics

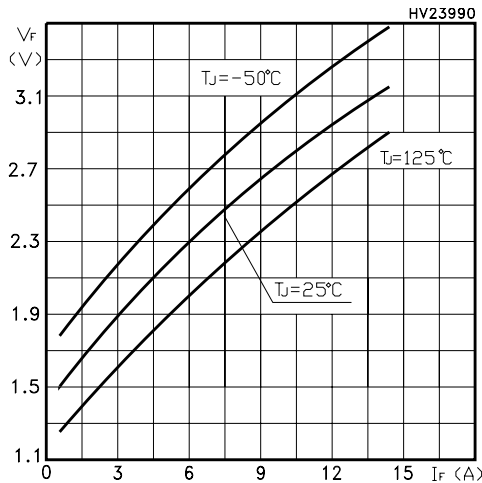

Figure 17: Turn-Off SOA

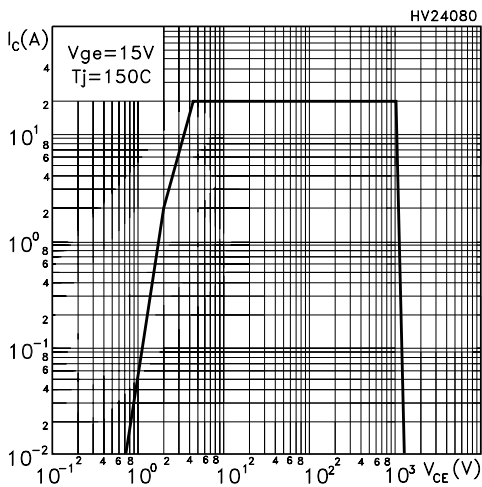

Figure 18: Power Losses

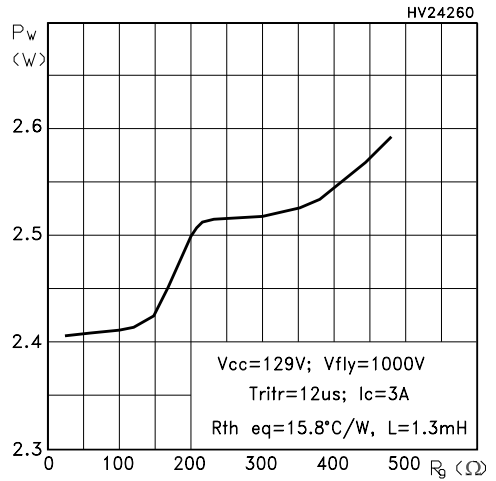

Figure 19: Power Losses

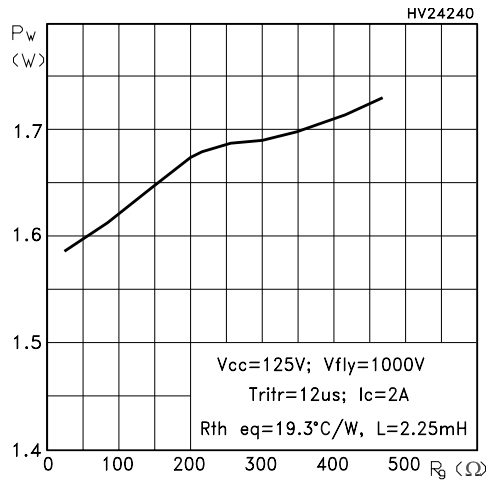

Figure 20: Test Circuit for Inductive Load Switching

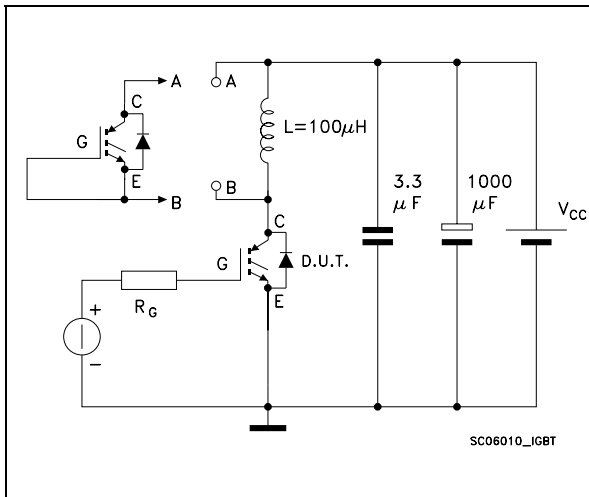

Figure 21: Switching Waveforms

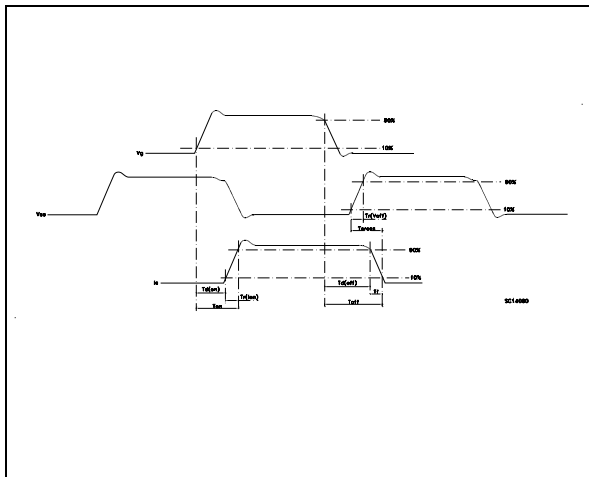

Figure 22: Gate Charge Test Circuit

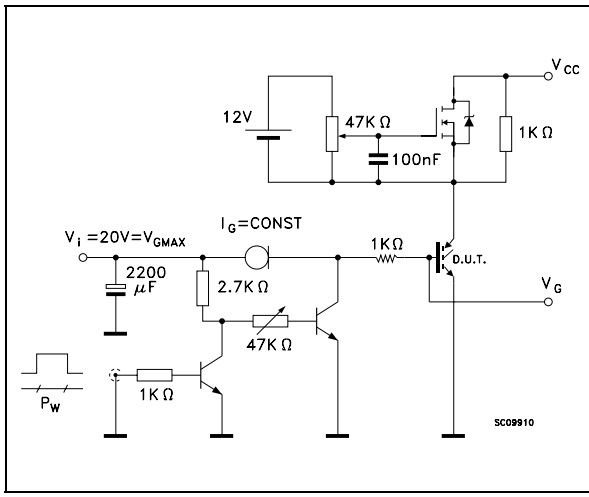
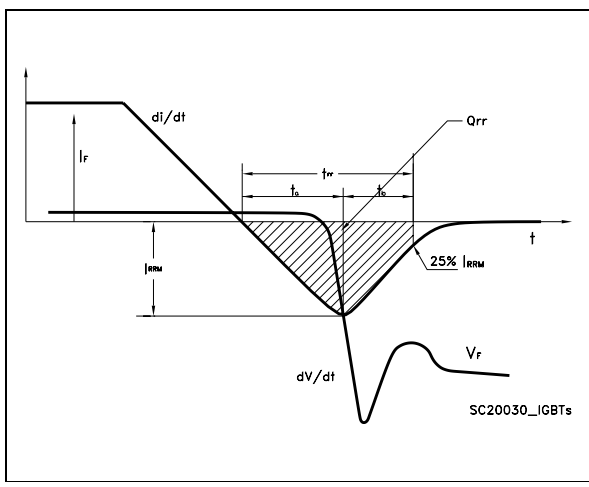

Figure 23: Diode Recovery Time Waveforms



TO-220FP MECHANICAL DATA

DIM.	mm.			inch		
	MIN.	TYP.	MAX.	MIN.	TYP.	MAX.
A	4.4		4.6	0.173		0.181
B	2.5		2.7	0.098		0.106
D	2.5		2.75	0.098		0.108
E	0.45		0.7	0.017		0.027
F	0.75		1	0.030		0.039
F1	1.15		1.7	0.045		0.067
F2	1.15		1.7	0.045		0.067
G	4.95		5.2	0.195		0.204
G1	2.4		2.7	0.094		0.106
H	10		10.4	0.393		0.409
L2		16			0.630	
L3	28.6		30.6	1.126		1.204
L4	9.8		10.6	.0385		0.417
L5	2.9		3.6	0.114		0.141
L6	15.9		16.4	0.626		0.645
L7	9		9.3	0.354		0.366
Ø	3		3.2	0.118		0.126

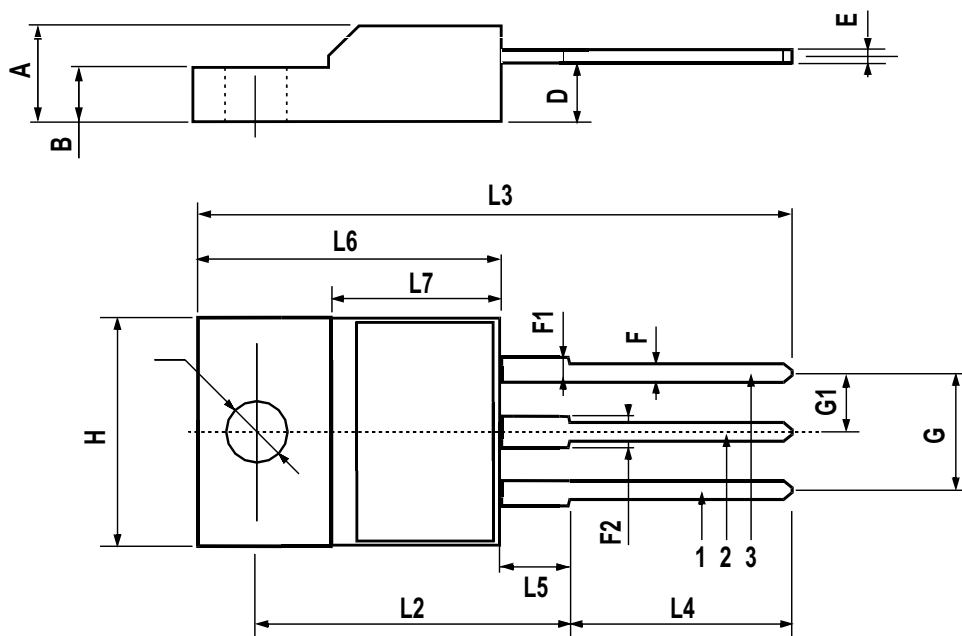

Table 11: Revision History

Date	Revision	Description of Changes
13-Dec-2004	1	First release
21-Jan-2005	2	Modified Curve 17

Information furnished is believed to be accurate and reliable. However, STMicroelectronics assumes no responsibility for the consequences of use of such information nor for any infringement of patents or other rights of third parties which may result from its use. No license is granted by implication or otherwise under any patent or patent rights of STMicroelectronics. Specifications mentioned in this publication are subject to change without notice. This publication supersedes and replaces all information previously supplied. STMicroelectronics products are not authorized for use as critical components in life support devices or systems without express written approval of STMicroelectronics.

The ST logo is a registered trademark of STMicroelectronics

All other names are the property of their respective owners

© 2005 STMicroelectronics - All Rights Reserved

STMicroelectronics group of companies

Australia - Belgium - Brazil - Canada - China - Czech Republic - Finland - France - Germany - Hong Kong - India - Israel - Italy - Japan - Malaysia - Malta - Morocco - Singapore - Spain - Sweden - Switzerland - United Kingdom - United States of America