



STW20NK70Z

N-CHANNEL 700V - 0.25Ω - 20A TO-247
Zener-Protected SuperMESH™ MOSFET

TYPE	V _{DSS}	R _{DS(on)}	I _D	P _w
STW20NK70Z	700 V	< 0.285 Ω	20 A	350 W

- TYPICAL R_{DS(on)} = 0.25 Ω
- EXTREMELY HIGH dv/dt CAPABILITY
- 100% AVALANCHE TESTED
- GATE CHARGE MINIMIZED
- VERY LOW INTRINSIC CAPACITANCES
- VERY GOOD MANUFACTURING REPEATIBILITY

DESCRIPTION

The SuperMESH™ series is obtained through an extreme optimization of ST's well established strip-based PowerMESH™ layout. In addition to pushing on-resistance significantly down, special care is taken to ensure a very good dv/dt capability for the most demanding applications. Such series complements ST full range of high voltage MOSFETs including revolutionary MDmesh™ products.

APPLICATIONS

- HIGH CURRENT, HIGH SPEED SWITCHING
- IDEAL FOR OFF-LINE POWER SUPPLIES

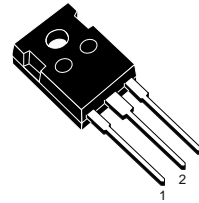

TO-247

INTERNAL SCHEMATIC DIAGRAM

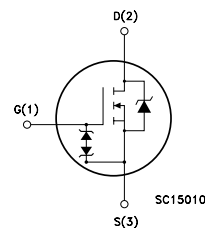

ORDER CODES

PART NUMBER	MARKING	PACKAGE	PACKAGING
STW20NK70Z	W20NK70Z	TO-247	TUBE

STW20NK70Z

ABSOLUTE MAXIMUM RATINGS

Symbol	Parameter	Value	Unit
V _{DS}	Drain-source Voltage (V _{GS} = 0)	700	V
V _{DGR}	Drain-gate Voltage (R _{GS} = 20 kΩ)	700	V
V _{GS}	Gate- source Voltage	± 30	V
I _D	Drain Current (continuous) at T _C = 25°C	20	A
I _D	Drain Current (continuous) at T _C = 100°C	12	A
I _{DM} (•)	Drain Current (pulsed)	80	A
P _{TOT}	Total Dissipation at T _C = 25°C	350	W
	Derating Factor	2.77	W/°C
V _{ESD(G-S)}	Gate source ESD(HBM-C=100pF, R=1.5KΩ)	6000	V
dv/dt (1)	Peak Diode Recovery voltage slope	4.5	V/ns
T _j T _{stg}	Operating Junction Temperature Storage Temperature	-55 to 150	°C

(•) Pulse width limited by safe operating area

(1) I_{SD} ≤ 20A, di/dt ≤ 200 A/μs, V_{DD} ≤ V_{(BR)DSS}, T_j ≤ T_{JMAX}.

(*) Limited only by maximum temperature allowed

THERMAL DATA

R _{thj-case}	Thermal Resistance Junction-case Max	0.36	°C/W
R _{thj-amb} T _I	Thermal Resistance Junction-ambient Max Maximum Lead Temperature For Soldering Purpose	50 300	°C/W °C

AVALANCHE CHARACTERISTICS

Symbol	Parameter	Max Value	Unit
I _{AR}	Avalanche Current, Repetitive or Not-Repetitive (pulse width limited by T _j max)	19	A
E _{AS}	Single Pulse Avalanche Energy (starting T _j = 25 °C, I _D = I _{AR} , V _{DD} = 50 V)	300	mJ

GATE-SOURCE ZENER DIODE

Symbol	Parameter	Test Conditions	Min.	Typ.	Max.	Unit
BV _{GSO}	Gate-Source Breakdown Voltage	I _{gs} =± 1mA (Open Drain)	30			V

PROTECTION FEATURES OF GATE-TO-SOURCE ZENER DIODES

The built-in back-to-back Zener diodes have specifically been designed to enhance not only the device's ESD capability, but also to make them safely absorb possible voltage transients that may occasionally be applied from gate to source. In this respect the Zener voltage is appropriate to achieve an efficient and cost-effective intervention to protect the device's integrity. These integrated Zener diodes thus avoid the usage of external components.

ELECTRICAL CHARACTERISTICS ($T_{CASE} = 25^{\circ}C$ UNLESS OTHERWISE SPECIFIED)
ON/OFF

Symbol	Parameter	Test Conditions	Min.	Typ.	Max.	Unit
$V_{(BR)DSS}$	Drain-source Breakdown Voltage	$I_D = 1\text{ mA}, V_{GS} = 0$	700			V
I_{DSS}	Zero Gate Voltage Drain Current ($V_{GS} = 0$)	$V_{DS} = \text{Max Rating}$ $V_{DS} = \text{Max Rating}, T_C = 125^{\circ}C$			1 50	μA μA
I_{GSS}	Gate-body Leakage Current ($V_{DS} = 0$)	$V_{GS} = \pm 20V$			± 10	μA
$V_{GS(th)}$	Gate Threshold Voltage	$V_{DS} = V_{GS}, I_D = 150\ \mu A$	3	3.75	4.5	V
$R_{DS(on)}$	Static Drain-source On Resistance	$V_{GS} = 10V, I_D = 10\text{ A}$		0.25	0.285	Ω

DYNAMIC

Symbol	Parameter	Test Conditions	Min.	Typ.	Max.	Unit
g_{fs} (1)	Forward Transconductance	$V_{DS} = 15\text{ V}, I_D = 10\text{ A}$		18		S
C_{iss} C_{oss} C_{rss}	Input Capacitance Output Capacitance Reverse Transfer Capacitance	$V_{DS} = 25V, f = 1\text{ MHz}, V_{GS} = 0$		6000 550 118		pF pF pF
$C_{oss\ eq.}$ (3)	Equivalent Output Capacitance	$V_{GS} = 0V, V_{DS} = 0V\text{ to }640V$		310		pF
$t_{d(on)}$ t_r $t_{d(off)}$ t_f	Turn-on Delay Time Rise Time Turn-off Delay Time Fall Time	$V_{DD} = 350\text{ V}, I_D = 10A$ $R_G = 4.7\ \Omega, V_{GS} = 10\text{ V}$ (Resistive Load see, Figure 3)		42 33 130 38		ns ns ns ns
Q_g Q_{gs} Q_{gd}	Total Gate Charge Gate-Source Charge Gate-Drain Charge	$V_{DD} = 560V, I_D = 20\text{ A},$ $V_{GS} = 10V$		185 38 92		nC nC nC

SOURCE DRAIN DIODE

Symbol	Parameter	Test Conditions	Min.	Typ.	Max.	Unit
I_{SD} I_{SDM} (2)	Source-drain Current Source-drain Current (pulsed)				20 80	A A
V_{SD} (1)	Forward On Voltage	$I_{SD} = 20\text{ A}, V_{GS} = 0$			1.6	V
t_{rr} Q_{rr} I_{RRM}	Reverse Recovery Time Reverse Recovery Charge Reverse Recovery Current	$I_{SD} = 20\text{ A}, di/dt = 100\text{ A}/\mu s$ $V_{DD} = 100\text{ V}, T_j = 25^{\circ}C$ (see test circuit, Figure 5)		940 16 35		ns μC A
t_{rr} Q_{rr} I_{RRM}	Reverse Recovery Time Reverse Recovery Charge Reverse Recovery Current	$I_{SD} = 20\text{ A}, di/dt = 100A/\mu s$ $V_{DD} = 100\text{ V}, T_j = 150^{\circ}C$ (see test circuit, Figure 5)		772 13 33		ns μC A

Note: 1. Pulsed: Pulse duration = 300 μs , duty cycle 1.5 %.
2. Pulse width limited by safe operating area.
3. $C_{oss\ eq.}$ is defined as a constant equivalent capacitance giving the same charging time as C_{oss} when V_{DS} increases from 0 to 80% V_{DSS} .

Safe Operating Area

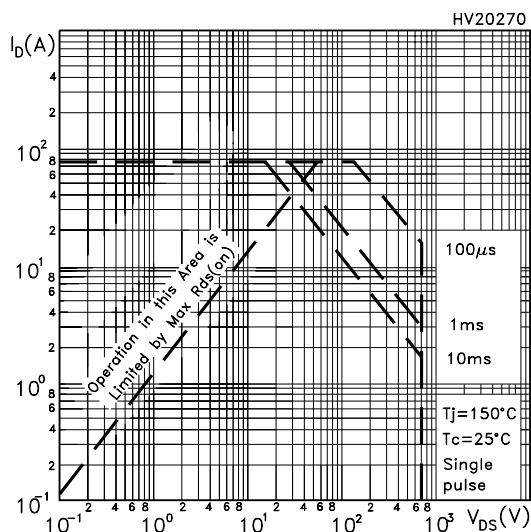

Thermal Impedance

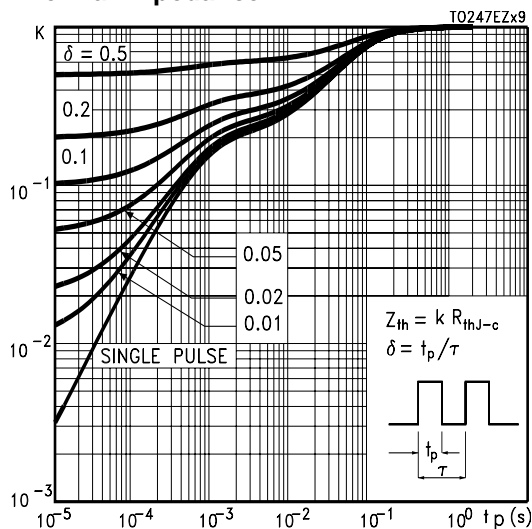

Output Characteristics

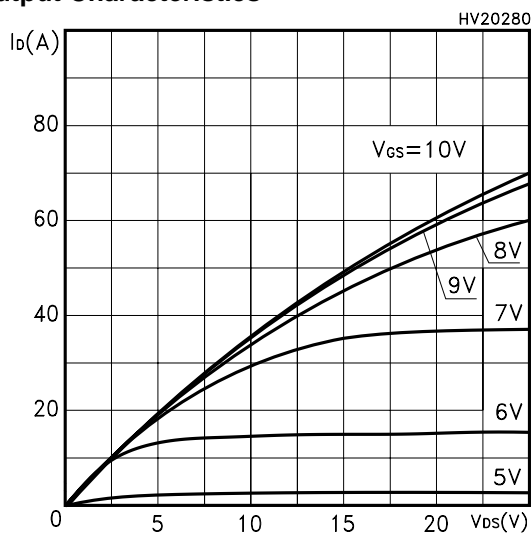

Transfer Characteristics

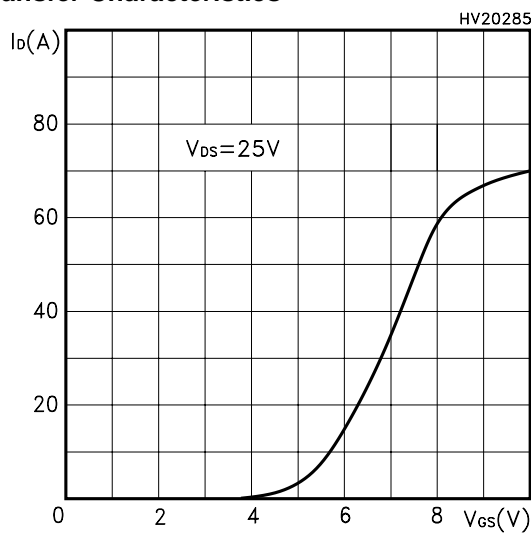

Transconductance

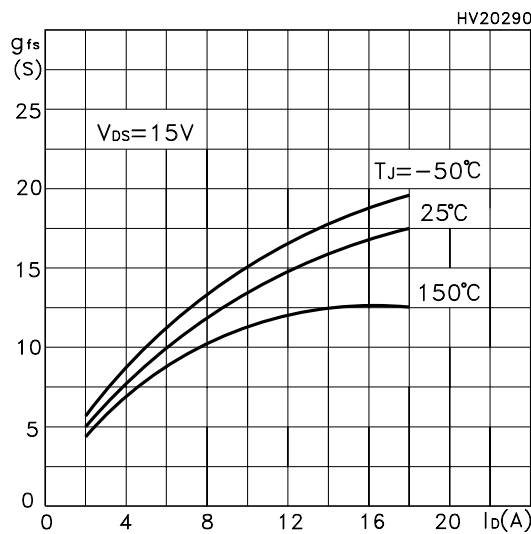

Static Drain-source On Resistance

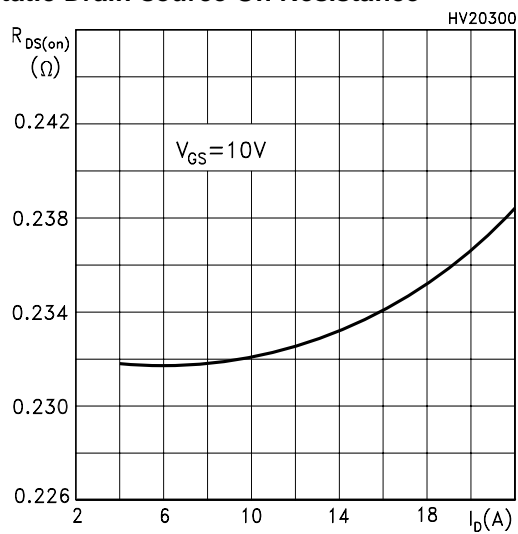

Gate Charge vs Gate-source Voltage

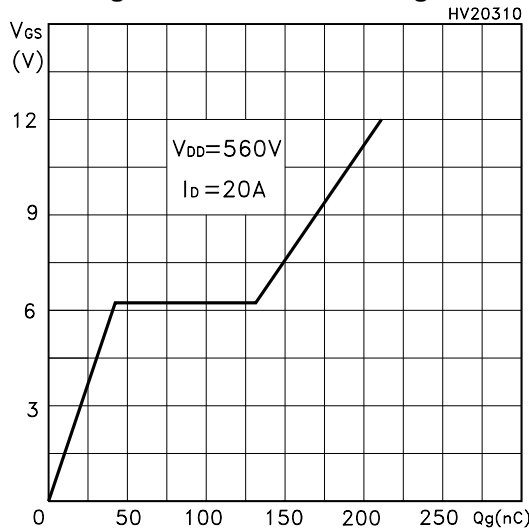

Capacitance Variations

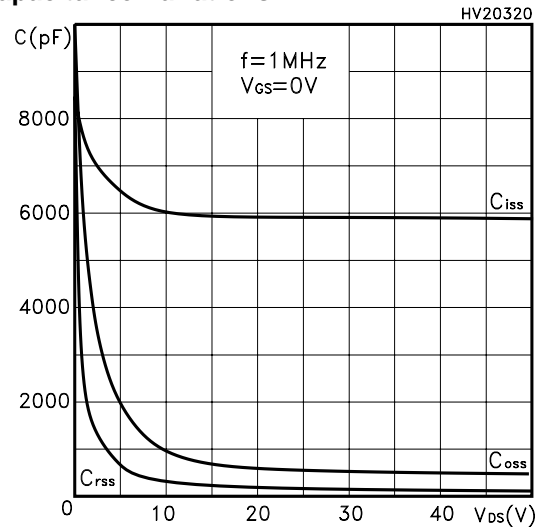

Normalized Gate Threshold Voltage vs Temp.

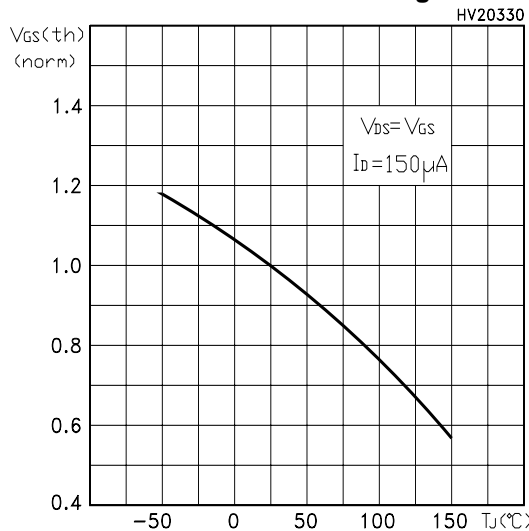

Normalized On Resistance vs Temperature

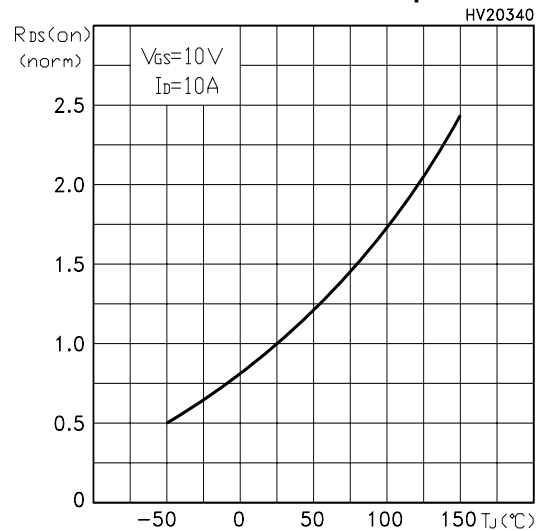

Source-drain Diode Forward Characteristics

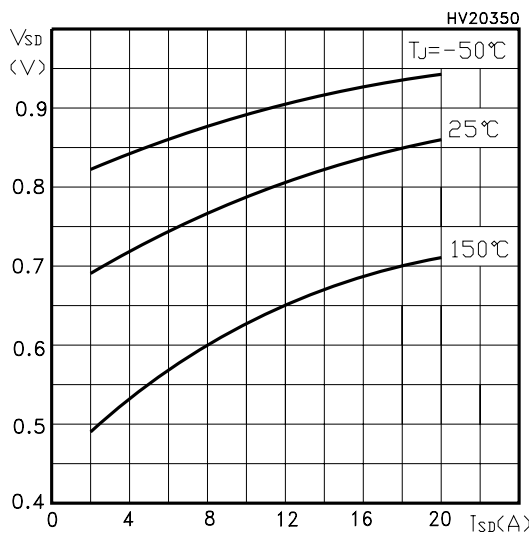

Normalized BVDSS vs Temperature

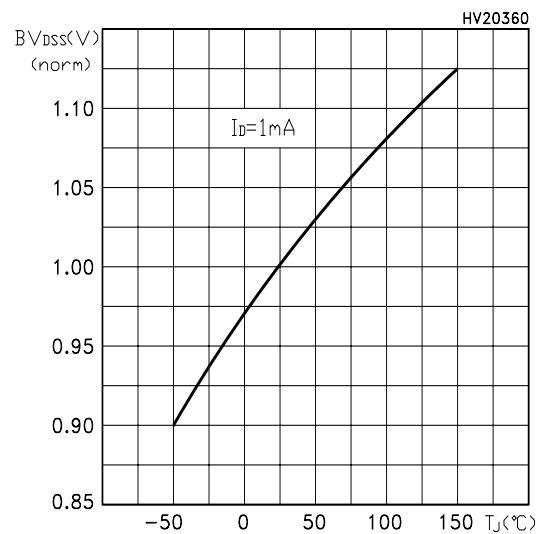

Maximum Avalanche Energy vs Temperature

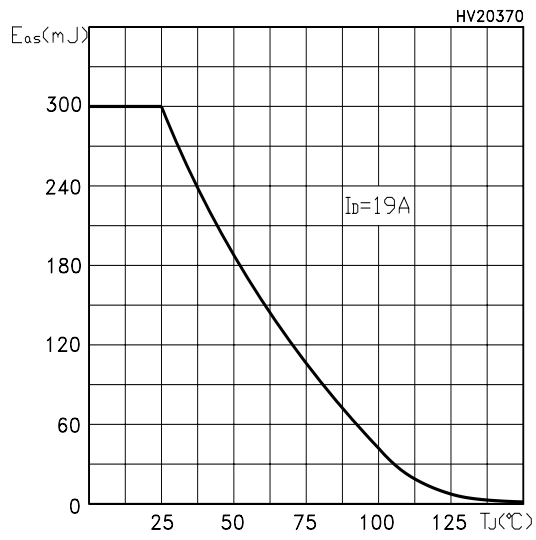

Fig. 1: Unclamped Inductive Load Test Circuit



Fig. 2: Unclamped Inductive Waveform



Fig. 3: Switching Times Test Circuit For Resistive Load



Fig. 4: Gate Charge test Circuit

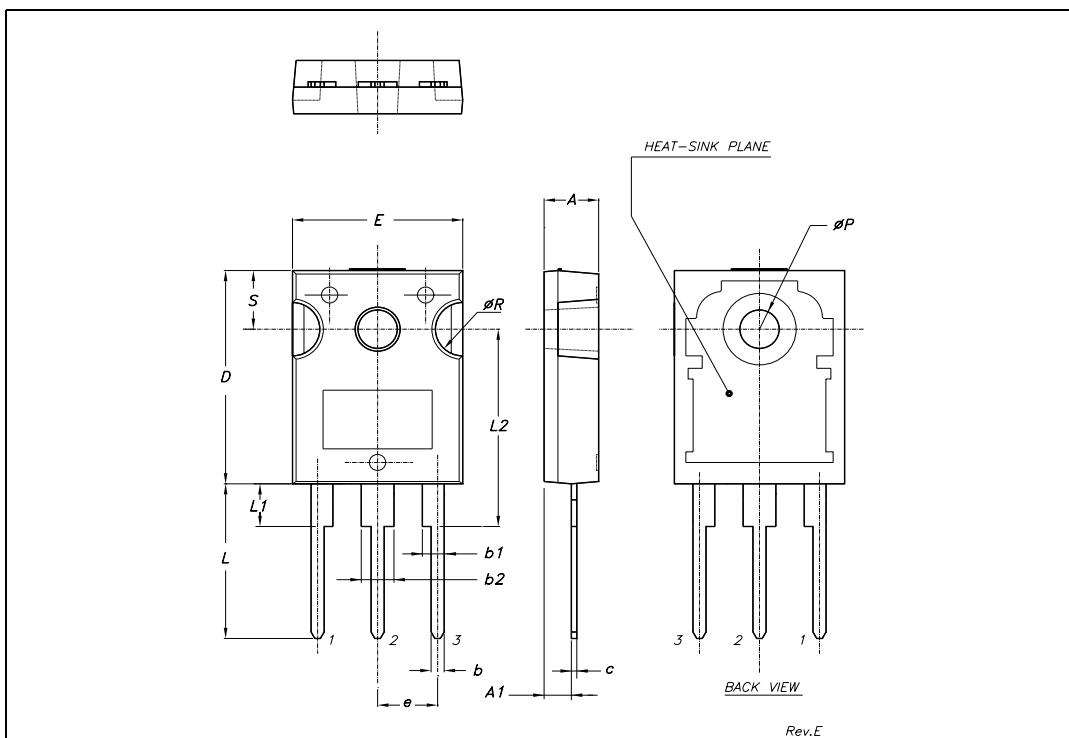

Fig. 5: Test Circuit For Inductive Load Switching And Diode Recovery Times



TO-247 MECHANICAL DATA

DIM.	mm.			inch		
	MIN.	TYP.	MAX.	MIN.	TYP.	MAX.
A	4.85		5.15	0.19		0.20
A1	2.20		2.60	0.086		0.102
b	1.0		1.40	0.039		0.055
b1	2.0		2.40	0.079		0.094
b2	3.0		3.40	0.118		0.134
c	0.40		0.80	0.015		0.03
D	19.85		20.15	0.781		0.793
E	15.45		15.75	0.608		0.620
e		5.45			0.214	
L	14.20		14.80	0.560		0.582
L1	3.70		4.30	0.14		0.17
L2		18.50			0.728	
øP	3.55		3.65	0.140		0.143
øR	4.50		5.50	0.177		0.216
S		5.50			0.216	



Information furnished is believed to be accurate and reliable. However, STMicroelectronics assumes no responsibility for the consequences of use of such information nor for any infringement of patents or other rights of third parties which may result from its use. No license is granted by implication or otherwise under any patent or patent rights of STMicroelectronics. Specifications mentioned in this publication are subject to change without notice. This publication supersedes and replaces all information previously supplied. STMicroelectronics products are not authorized for use as critical components in life support devices or systems without express written approval of STMicroelectronics.

The ST logo is a registered trademark of STMicroelectronics
All other names are the property of their respective owners

© 2004 STMicroelectronics - All Rights Reserved
STMicroelectronics GROUP OF COMPANIES

Australia - Belgium - Brazil - Canada - China - Czech Republic - Finland - France - Germany - Hong Kong - India - Israel - Italy - Japan -
Malaysia - Malta - Morocco - Singapore - Spain - Sweden - Switzerland - United Kingdom - United States.
<http://www.st.com>