

# ZXMP6A18DN8

## DUAL P-CHANNEL 60V ENHANCEMENT MODE MOSFET

### SUMMARY

$V_{(BR)DSS} = -60V$ ;  $R_{DS(ON)} = 0.055\Omega$ ;  $I_D = -4.8A$

### DESCRIPTION

This new generation of trench MOSFETs from Zetex utilizes a unique structure that combines the benefits of low on-resistance with fast switching speed. This makes them ideal for high efficiency, low voltage, power management applications.

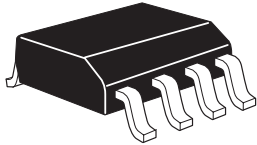

SO8

### FEATURES

- Low on-resistance
- Fast switching speed
- Low threshold
- Low gate drive
- Low profile SOIC package

### APPLICATIONS

- Motor drive
- Disconnect switches

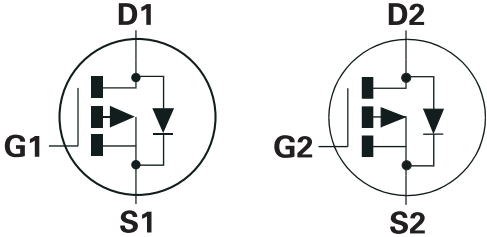

### ORDERING INFORMATION

DEVICE	REEL	TAPE WIDTH	QUANTITY PER REEL
ZXMP6A18DN8TA	7"	12mm	500 units
ZXMP6A18DN8TC	13"	12mm	2500 units

### DEVICE MARKING

ZXMP  
6A18

### PINOUT

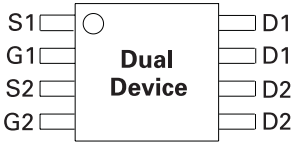

Top view

# ZXMP6A18DN8

## ABSOLUTE MAXIMUM RATINGS

PARAMETER	SYMBOL	LIMIT	UNIT
Drain-Source Voltage	$V_{DSS}$	-60	V
Gate-Source Voltage	$V_{GS}$	$\pm 20$	V
Continuous Drain Current @ $V_{GS}=10V$ ; $T_A=25^\circ C$ (b)(d) @ $V_{GS}=10V$ ; $T_A=70^\circ C$ (b)(d) @ $V_{GS}=10V$ ; $T_A=25^\circ C$ (a)(d)	$I_D$	-4.8 -3.8 -3.7	A A A
Pulsed Drain Current (c)	$I_{DM}$	-23	A
Continuous Source Current (Body Diode)(b)	$I_S$	-3.3	A
Pulsed Source Current (Body Diode)(c)	$I_{SM}$	-23	A
Power Dissipation at $T_A=25^\circ C$ (a)(d) Linear Derating Factor	$P_D$	1.25 10	W mW/ $^\circ C$
Power Dissipation at $T_A=25^\circ C$ (a)(e) Linear Derating Factor	$P_D$	1.8 14	W mW/ $^\circ C$
Power Dissipation at $T_A=25^\circ C$ (b)(d) Linear Derating Factor	$P_D$	2.1 17	W mW/ $^\circ C$
Operating and Storage Temperature Range	$T_j; T_{stg}$	-55 to +150	$^\circ C$

## THERMAL RESISTANCE

PARAMETER	SYMBOL	VALUE	UNIT
Junction to Ambient (a)(d)	$R_{\theta JA}$	100	$^\circ C/W$
Junction to Ambient (b)(e)	$R_{\theta JA}$	69	$^\circ C/W$
Junction to Ambient (b)(d)	$R_{\theta JA}$	58	$^\circ C/W$

### Notes

(a) For a dual device surface mounted on 25mm x 25mm x 1.6mm FR4 PCB with a high coverage of single sided 1oz copper in still air conditions.

(b) For a dual device surface mounted on FR4 PCB measured at  $t \leq 10$  sec.

(c) Repetitive rating 25mm x 25mm FR4 PCB,  $D=0.02$ , pulse width=300 $\mu s$  - pulse width limited by maximum junction temperature.

(d) For a dual device with one active die.

(e) For a device with two active die running at equal power.

# ZXMP6A18DN8

## CHARACTERISTICS

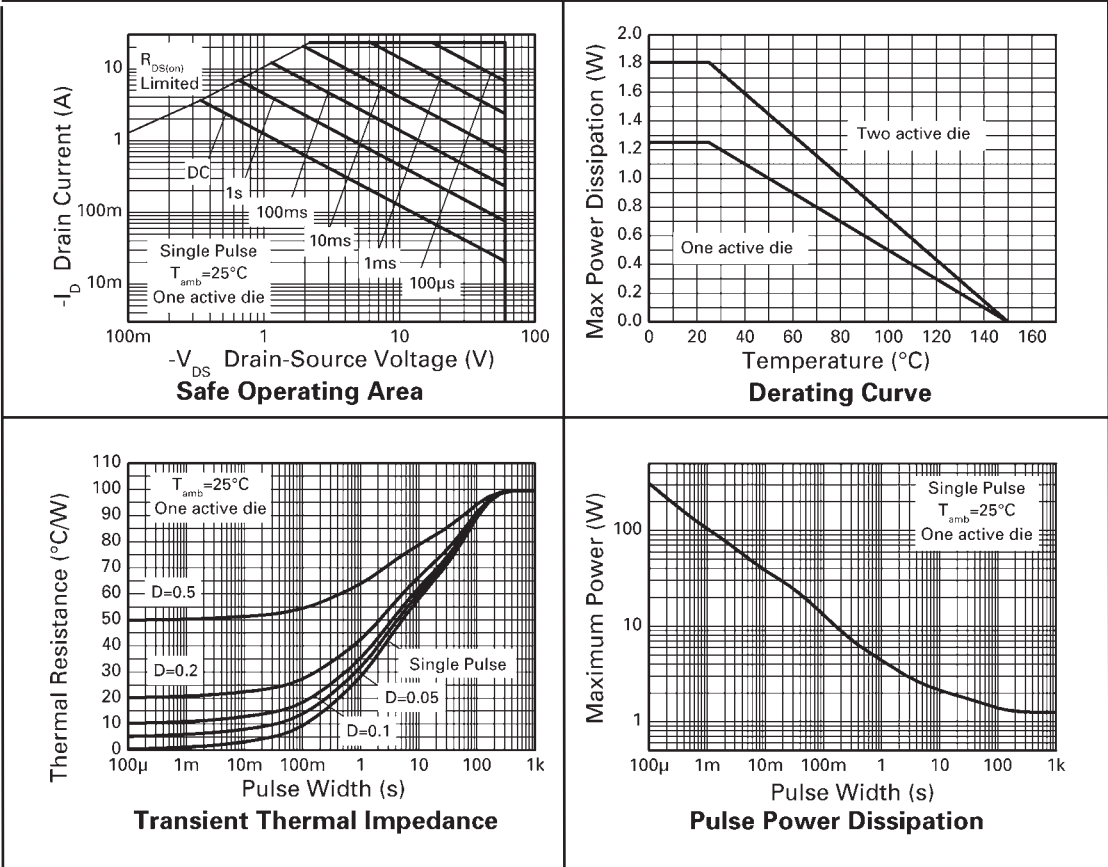

# ZXMP6A18DN8

## ELECTRICAL CHARACTERISTICS (at $T_{amb} = 25^{\circ}\text{C}$ unless otherwise stated)

PARAMETER	SYMBOL	MIN.	TYP.	MAX.	UNIT	CONDITIONS
<b>STATIC</b>						
Drain-Source Breakdown Voltage	$V_{(BR)DSS}$	-60			V	$I_D = -250\mu\text{A}$ , $V_{GS} = 0\text{V}$
Zero Gate Voltage Drain Current	$I_{DSS}$			-1.0	$\mu\text{A}$	$V_{DS} = -60\text{V}$ , $V_{GS} = 0\text{V}$
Gate-Body Leakage	$I_{GSS}$			100	nA	$V_{GS} = \pm 20\text{V}$ , $V_{DS} = 0\text{V}$
Gate-Source Threshold Voltage	$V_{GS(th)}$	-1.0			V	$I_D = -250\mu\text{A}$ , $V_{DS} = V_{GS}$
Static Drain-Source On-State Resistance <sup>(1)</sup>	$R_{DS(on)}$			0.055 0.080	$\Omega$ $\Omega$	$V_{GS} = -10\text{V}$ , $I_D = -3.5\text{A}$ $V_{GS} = -4.5\text{V}$ , $I_D = -2.9\text{A}$
Forward Transconductance <sup>(1)(3)</sup>	$g_{fs}$		8.7		S	$V_{DS} = -15\text{V}$ , $I_D = -3.5\text{A}$
<b>DYNAMIC</b> <sup>(3)</sup>						
Input Capacitance	$C_{iss}$		1580		pF	$V_{DS} = -30\text{V}$ , $V_{GS} = 0\text{V}$ , $f = 1\text{MHz}$
Output Capacitance	$C_{oss}$		160		pF	
Reverse Transfer Capacitance	$C_{rss}$		140		pF	
<b>SWITCHING</b> <sup>(2) (3)</sup>						
Turn-On Delay Time	$t_{d(on)}$		4.6		ns	$V_{DD} = -30\text{V}$ , $I_D = -1\text{A}$ $R_G \approx 6.0\Omega$ , $V_{GS} = -10\text{V}$
Rise Time	$t_r$		5.8		ns	
Turn-Off Delay Time	$t_{d(off)}$		55		ns	
Fall Time	$t_f$		23		ns	
Gate Charge	$Q_g$		23		nC	$V_{DS} = -30\text{V}$ , $V_{GS} = -5\text{V}$ , $I_D = -3.5\text{A}$
Total Gate Charge	$Q_g$		44		nC	$V_{DS} = -30\text{V}$ , $V_{GS} = -10\text{V}$ , $I_D = -3.5\text{A}$
Gate-Source Charge	$Q_{gs}$		3.9		nC	
Gate-Drain Charge	$Q_{gd}$		9.8		nC	
<b>SOURCE-DRAIN DIODE</b>						
Diode Forward Voltage <sup>(1)</sup>	$V_{SD}$		-0.85	-0.95	V	$T_J = 25^{\circ}\text{C}$ , $I_S = -4.2\text{A}$ , $V_{GS} = 0\text{V}$
Reverse Recovery Time <sup>(3)</sup>	$t_{rr}$		37		ns	$T_J = 25^{\circ}\text{C}$ , $I_F = -2.1\text{A}$ , $di/dt = 100\text{A}/\mu\text{s}$
Reverse Recovery Charge <sup>(3)</sup>	$Q_{rr}$		56		nC	

### NOTES

- (1) Measured under pulsed conditions. Width  $\leq 300\mu\text{s}$ . Duty cycle  $\leq 2\%$ .  
(2) Switching characteristics are independent of operating junction temperature.  
(3) For design aid only, not subject to production testing.

# ZXMP6A18DN8

## TYPICAL CHARACTERISTICS

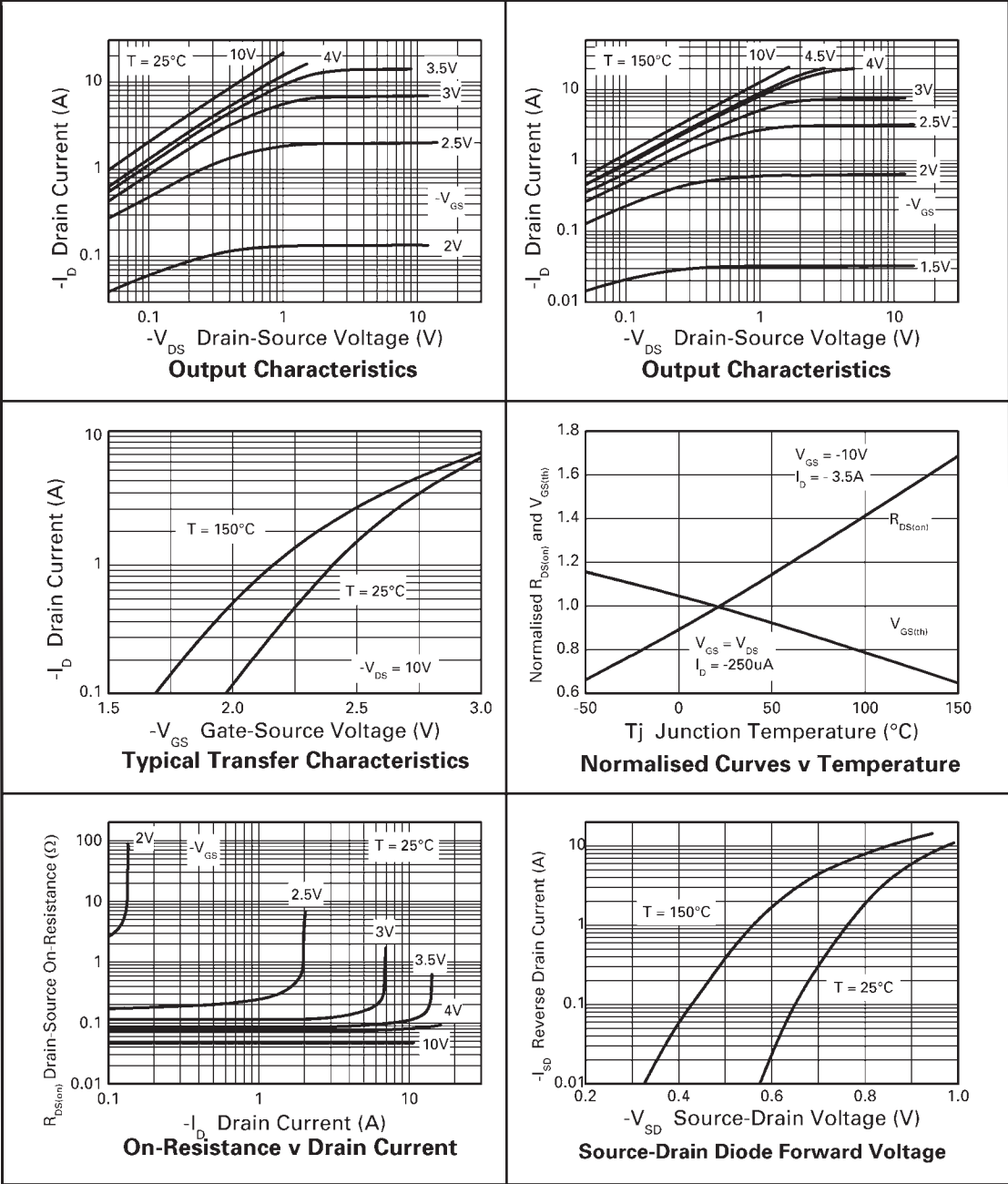

# ZXMP6A18DN8

## TYPICAL CHARACTERISTICS

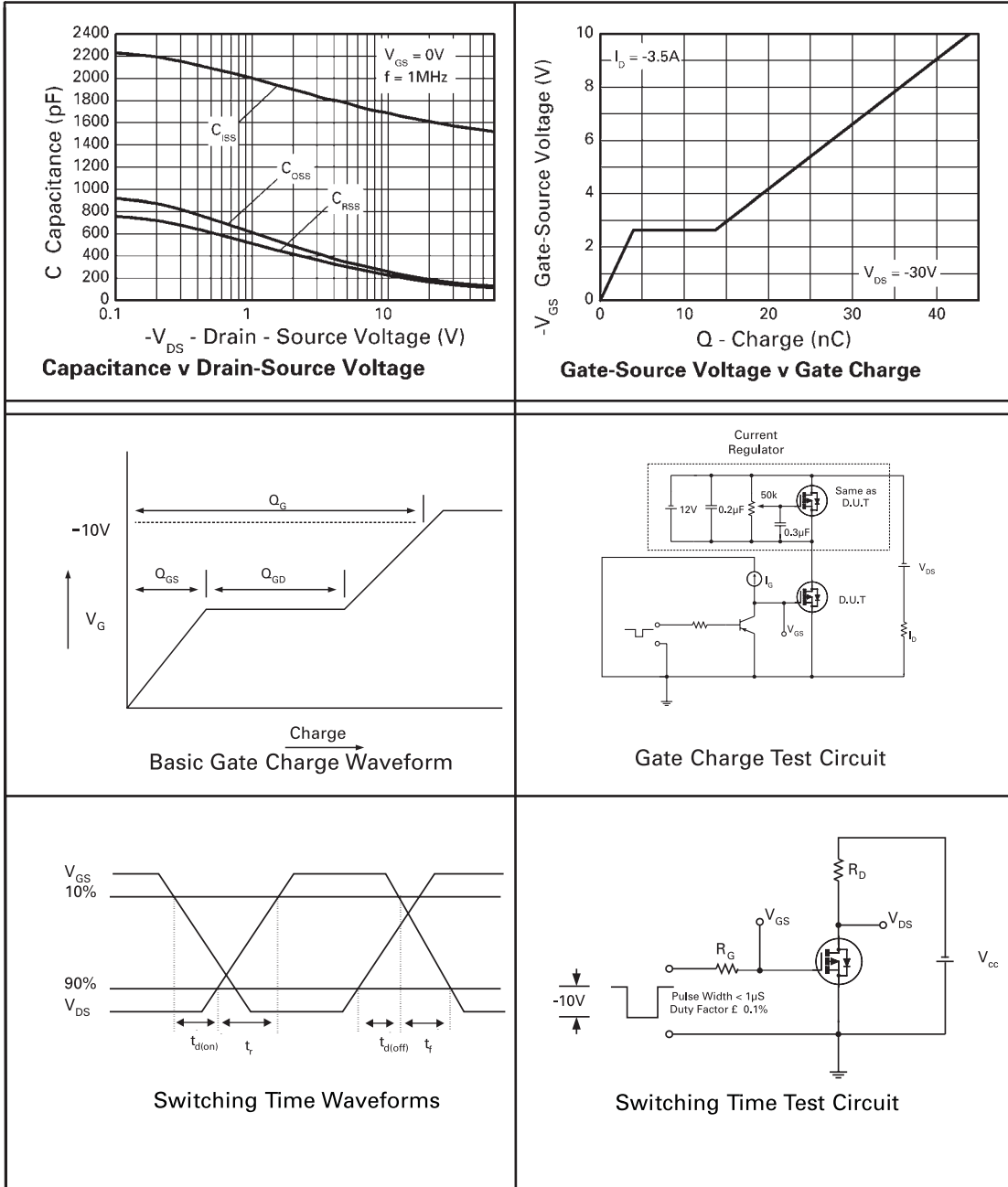

# ZXMP6A18DN8

## PACKAGE OUTLINE

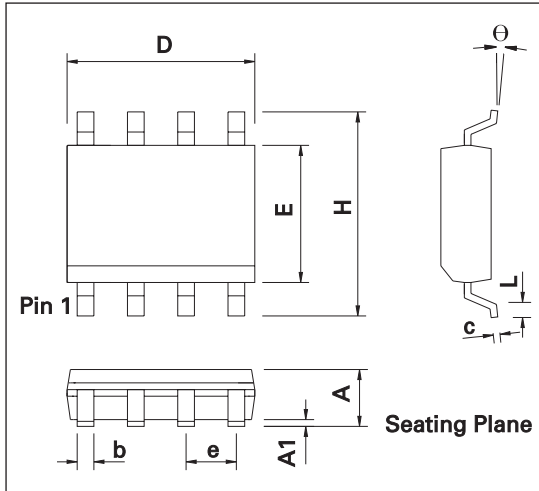

CONTROLLING DIMENSIONS ARE IN INCHES  
APPROX IN MILLIMETERS

## PACKAGE DIMENSIONS

DIM	Millimeters		Inches		DIM	Millimeters		Inches	
	Min	Max	Min	Max		Min	Max	Min	Max
A	1.35	1.75	0.053	0.069	e	1.27 BSC		0.050 BSC	
A1	0.10	0.25	0.004	0.010	b	0.33	0.51	0.013	0.020
D	4.80	5.00	0.189	0.197	c	0.19	0.25	0.008	0.010
H	5.80	6.20	0.228	0.244	Θ	0°	8°	0°	8°
E	3.80	4.00	0.150	0.157	h	0.25	0.50	0.010	0.020

© Zetex Semiconductors plc 2005

Europe	Americas	Asia Pacific	Corporate Headquarters
Zetex GmbH Streitfeldstraße 19 D-81673 München Germany	Zetex Inc 700 Veterans Memorial Hwy Hauppauge, NY 11788 USA	Zetex (Asia) Ltd 3701-04 Metroplaza Tower 1 Hing Fong Road, Kwai Fong Hong Kong	Zetex Semiconductors plc Zetex Technology Park Chadderton, Oldham, OL9 9LL United Kingdom
Telephone: (49) 89 45 49 49 0 Fax: (49) 89 45 49 49 49 <a href="mailto:europa.sales@zetex.com">europa.sales@zetex.com</a>	Telephone: (1) 631 360 2222 Fax: (1) 631 360 8222 <a href="mailto:usa.sales@zetex.com">usa.sales@zetex.com</a>	Telephone: (852) 26100 611 Fax: (852) 24250 494 <a href="mailto:asia.sales@zetex.com">asia.sales@zetex.com</a>	Telephone (44) 161 622 4444 Fax: (44) 161 622 4446 <a href="mailto:hq@zetex.com">hq@zetex.com</a>

These offices are supported by agents and distributors in major countries world-wide.

This publication is issued to provide outline information only which (unless agreed by the Company in writing) may not be used, applied or reproduced for any purpose or form part of any order or contract or be regarded as a representation relating to the products or services concerned. The Company reserves the right to alter without notice the specification, design, price or conditions of supply of any product or service.

For the latest product information, log on to [www.zetex.com](http://www.zetex.com)

ISSUE 1 - MAY 2005