

HDSP-511x/513x

14.22 mm (0.56 inch) General Purpose
Seven-Segment Display

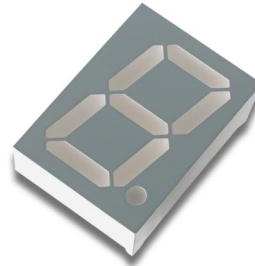

Data Sheet

Description

This 14.22 mm (0.56 inch) LED seven-segment display uses industry standard size package and pinout. The device is available in either common anode or common cathode. The choice of colors includes High Efficiency Red (HER), Green, AlGaAs Red, and Yellow. The gray face displays are suitable for indoor use.

Applications

- Suitable for indoor use
- Not recommended for industrial application, i.e., operating temperature requirements exceeding +85 °C or below -25 °C^[1]
- Extreme temperature cycling not recommended

Note:

1. For additional details, please contact your local Avago sales office or an authorized distributor.

Features

- **Industry standard size**
- **Industry standard pinout**
14.22 mm (0.56 inch)
DIP lead on 2.54 mm
- **Choice of colors**
High Efficiency Red (HER), Green, AlGaAs Red, and Yellow
- **Excellent appearance**
Evenly lighted segments gray package gives optimum contrast
± 50° viewing angle
- **Design flexibility**
Common anode or common cathode
Single digit
Left and right hand decimal point
- **Categorized for luminous intensity**
Green and yellow categorized for color

Devices

| HER | Green | AlGaAs Red | Yellow | Description |
|-----------|-----------|------------|-----------|------------------------------------|
| HDSP-511E | HDSP-511G | HDSP-511A | HDSP-511Y | Common Anode, Right Hand Decimal |
| HDSP-513E | HDSP-513G | HDSP-513A | HDSP-513Y | Common Cathode, Right Hand Decimal |

Part Numbering System

5082 -X X X X-X X X X X

HDSP-X X X X-X X X X X

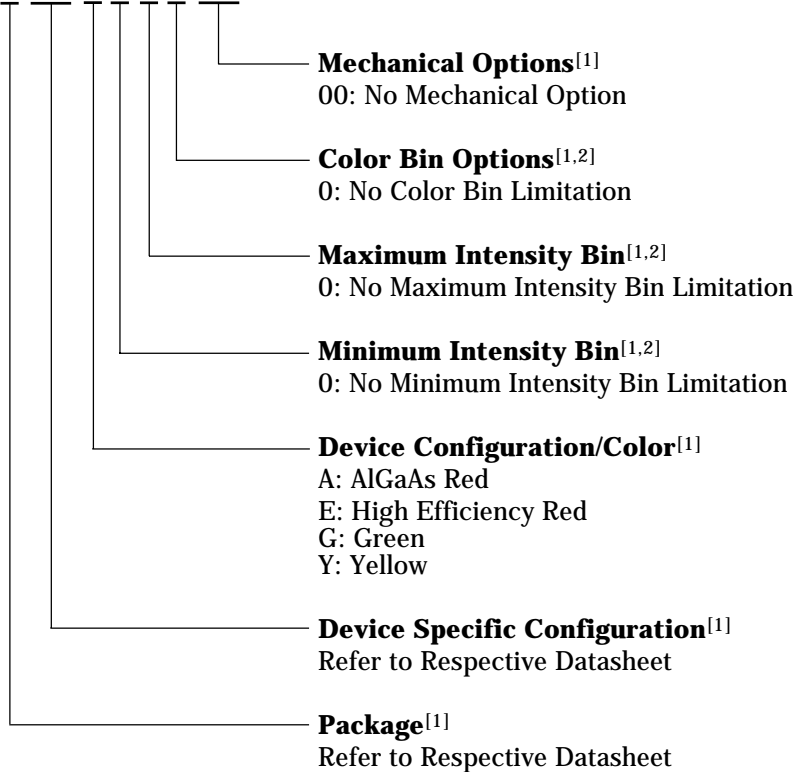

Notes:

1. For codes not listed in the figure above, please refer to the respective datasheet or contact your nearest Avago representative for details.
2. Bin options refer to shippable bins for a part number. Color and Intensity Bins are typically restricted to 1 bin per tube (exceptions may apply). Please refer to respective datasheet for specific bin limit information.

Package Dimensions

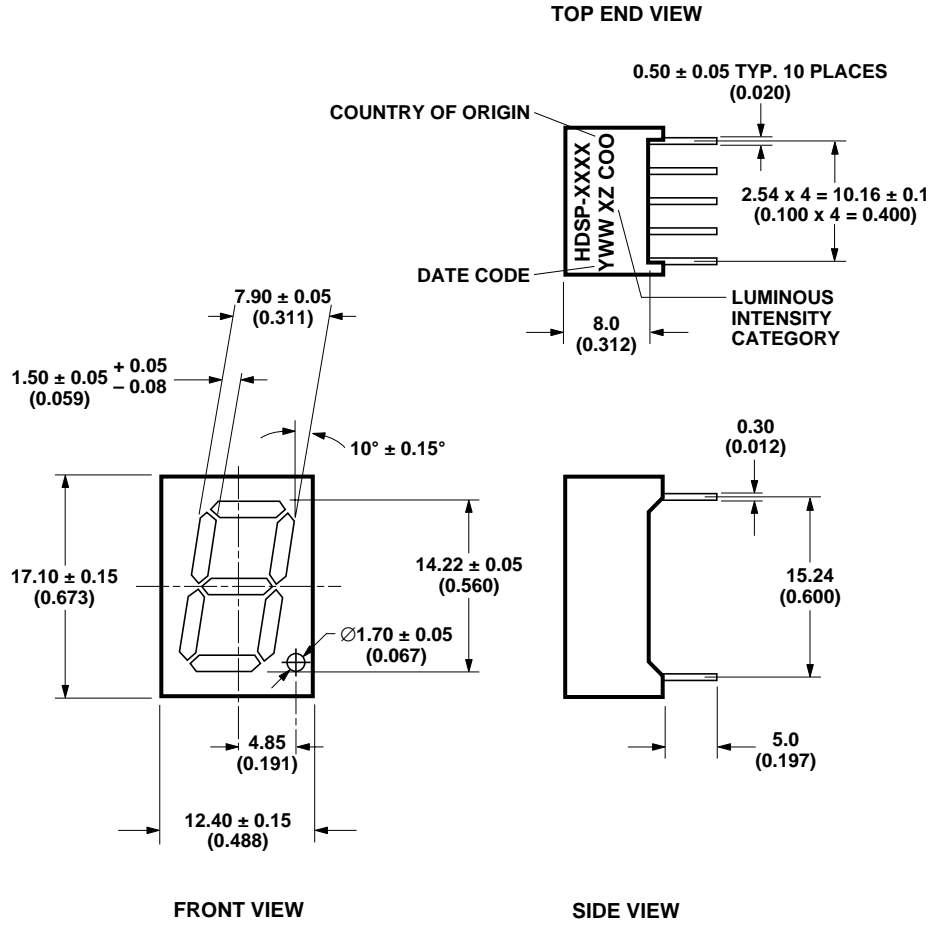

ALL DIMENSIONS ARE IN MILLIMETERS (INCHES).

Internal Circuit Diagram

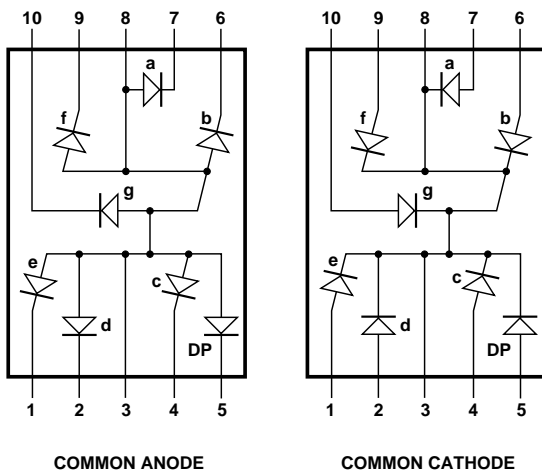

| HDSP-511E/511G/511Y/511A | | HDSP-513E/513G/513Y/513A | |
|--------------------------|--------------|--------------------------|----------------|
| COMMON ANODE | | COMMON CATHODE | |
| PIN | FUNCTION | PIN | FUNCTION |
| 1 | CATHODE e | 1 | ANODE e |
| 2 | CATHODE d | 2 | ANODE d |
| 3 | COMMON ANODE | 3 | COMMON CATHODE |
| 4 | CATHODE c | 4 | ANODE c |
| 5 | CATHODE DP | 5 | ANODE DP |
| 6 | CATHODE b | 6 | ANODE b |
| 7 | CATHODE a | 7 | ANODE a |
| 8 | COMMON ANODE | 8 | COMMON CATHODE |
| 9 | CATHODE f | 9 | ANODE f |
| 10 | CATHODE g | 10 | ANODE g |

Absolute Maximum Ratings at T_A = 25°C

| Description | HER HDSP-51xE | Green HDSP-51xG | AlGaAs Red HDSP-51xA | Yellow HDSP-51xY | Units |
|---|-------------------|--------------------|-------------------------|---------------------|-------|
| Power Dissipation Segment | 60 | 65 | 30 | 52 | mW |
| Forward Current Segment | 25 ^[1] | 25 ^[2] | 15 ^[3] | 20 ^[4] | mA |
| Peak Forward Current per Segment (1/10 Duty Factor at 10 KHz) | 100 | 100 | 80 | 80 | mA |
| Operating Temperature Range | -35 to +85 | -35 to +85 | -35 to +85 | -35 to +85 | °C |
| Storage Temperature Range | -35 to +85 | -35 to +85 | -35 to +85 | -35 to +85 | °C |
| Reverse Voltage per Segment or DP | 5 | 5 | 5 | 5 | V |
| Wavesoldering Temperature for 3 seconds (at 2 mm Distance from the body) | 250 | 250 | 250 | 250 | °C |

Notes:

1. Derate above 25°C at 0.33 mA/°C.
2. Derate above 25°C at 0.33 mA/°C.
3. Derate above 25°C at 0.2 mA/°C.
4. Derate above 25°C at 0.27 mA/°C.

Electrical/Optical Characteristics at T_A = 25°C

High Efficiency Red (HER)

| Device HDSP- | Parameter | Symbol | Min. | Typ. | Max. | Units | Test Conditions |
|-----------------|----------------------------|-------------------|-------|-------|------|-------|-------------------------|
| 511E | Luminous Intensity/Segment | I _V | | 1.73 | | mcd | I _F = 5 mA |
| 513E | | | 2.001 | 4.100 | | mcd | I _F = 10 mA |
| | Forward Voltage | V _F | | 2.05 | 2.40 | V | I _F = 20 mA |
| | Peak Wavelength | λ _{PEAK} | | 635 | | nm | |
| | Dominant Wavelength | λ _d | | 620 | | nm | |
| | Reverse Voltage | VR | 5 | | | V | I _R = 100 μA |

Green

| Device HDSP- | Parameter | Symbol | Min. | Typ. | Max. | Units | Test Conditions |
|-----------------|----------------------------|-------------------|-------|-------|------|-------|-------------------------|
| 511G | Luminous Intensity/Segment | I _V | 2.001 | 4.100 | | mcd | I _F = 10 mA |
| 513G | Forward Voltage | V _F | | 2.06 | | V | I _F = 10 mA |
| | | | 1.80 | 2.25 | 2.60 | V | I _F = 20 mA |
| | Peak Wavelength | λ _{PEAK} | | 568 | | nm | |
| | Dominant Wavelength | λ _d | | 573 | | nm | |
| | Reverse Voltage | VR | 5 | | | V | I _R = 100 μA |

AlGaAs Red

| Device | Parameter | Symbol | Min. | Typ. | Max. | Units | Test Conditions |
|--------|----------------------------|------------------|-------|-------|------|-------|-------------------------|
| 511A | Luminous Intensity/Segment | I_V | | 4.93 | | mcd | $I_F = 5 \text{ mA}$ |
| 513A | | | 3.201 | 6.500 | | mcd | $I_F = 10 \text{ mA}$ |
| | Forward Voltage | V_F | | 1.85 | 2.00 | V | $I_F = 20 \text{ mA}$ |
| | Peak Wavelength | λ_{PEAK} | | 660 | | nm | |
| | Dominant Wavelength | λ_d | | 643 | | nm | |
| | Reverse Voltage | VR | 5 | | | V | $I_R = 100 \mu\text{A}$ |

Yellow

| Device | Parameter | Symbol | Min. | Typ. | Max. | Units | Test Conditions |
|--------|----------------------------|------------------|-------|-------|------|-------|-------------------------|
| 511Y | Luminous Intensity/Segment | I_V | | 1.03 | | mcd | $I_F = 5 \text{ mA}$ |
| 513Y | | | 1.251 | 2.600 | | mcd | $I_F = 10 \text{ mA}$ |
| | Forward Voltage | V_F | | 2.15 | 2.60 | V | $I_F = 20 \text{ mA}$ |
| | Peak Wavelength | λ_{PEAK} | | 595 | | nm | |
| | Dominant Wavelength | λ_d | | 590 | | nm | |
| | Reverse Voltage | VR | 5 | | | V | $I_R = 100 \mu\text{A}$ |

Intensity Bin Limits (mcd at 10 mA)

| Bin Name | HER/Green | | Yellow | | AlGaAs Red | |
|----------|---------------------|---------------------|---------------------|---------------------|---------------------|---------------------|
| | Min. ^[1] | Max. ^[1] | Min. ^[1] | Max. ^[1] | Min. ^[1] | Max. ^[1] |
| H | NA | NA | 1.251 | 2.000 | NA | NA |
| I | 2.001 | 3.200 | 2.001 | 3.200 | NA | NA |
| J | 3.201 | 5.050 | 3.201 | 5.050 | 3.201 | 5.050 |
| K | 5.051 | 8.000 | NA | NA | 5.051 | 8.000 |
| L | NA | NA | NA | NA | 8.001 | 12.650 |

Note:

1. Tolerance for each bin limit is $\pm 10\%$.

Color Bin Limits (nm at 10 mA)

| Color | Bin | Dominant Wavelength (nm) | |
|--------|-----|--------------------------|---------------------|
| | | Min. ^[1] | Max. ^[1] |
| Green | 3 | 569.1 | 571.0 |
| | 4 | 571.1 | 573.0 |
| | 5 | 573.1 | 575.0 |
| Yellow | 1 | 585.5 | 588.5 |
| | 2 | 588.5 | 591.5 |
| | 3 | 591.5 | 594.5 |

Note:

1. Tolerance for each bin limit is 1 nm.

High Efficiency Red (HER)

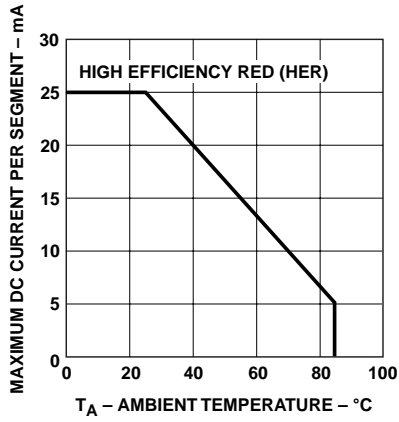

Figure 1. Maximum allowable average or DC current vs. ambient temperature.

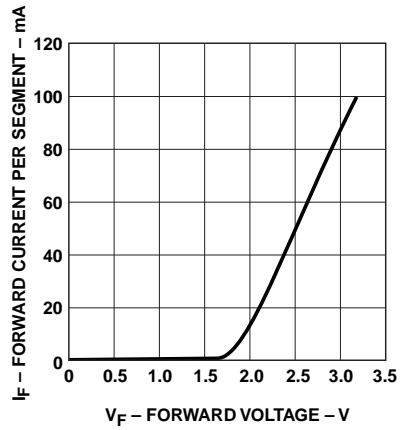

Figure 2. Forward current vs. forward voltage.

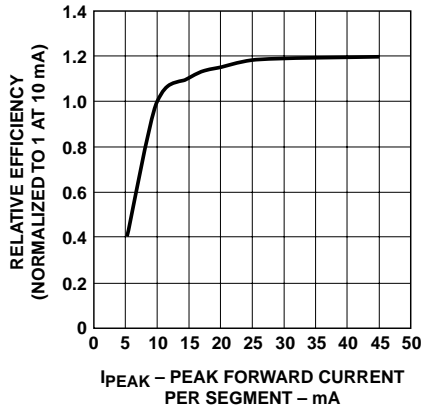

Figure 3. Relative luminous intensity vs. DC forward current.

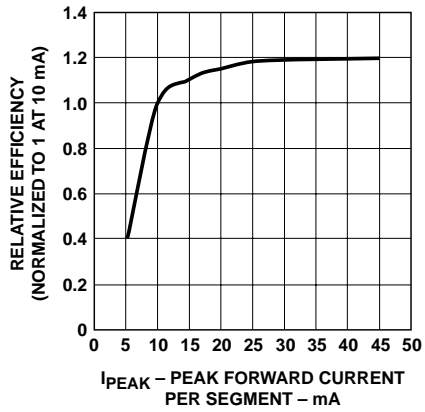

Figure 4. Relative efficiency (luminous intensity per unit current) vs. peak current.

Green

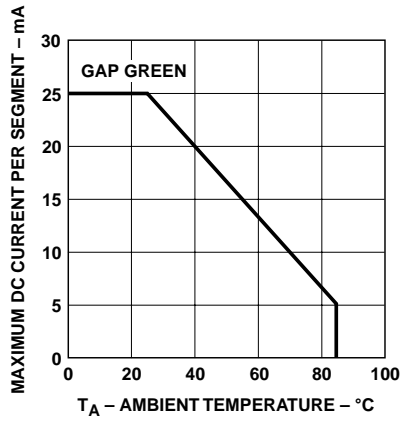

Figure 5. Maximum allowable average or DC current vs. ambient temperature.

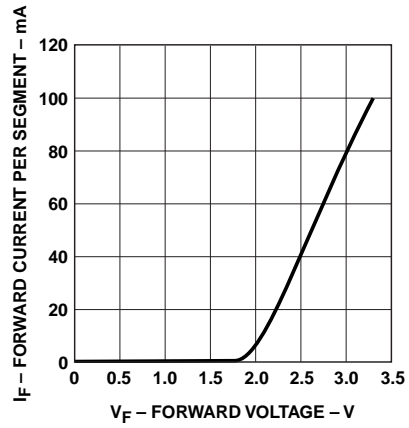

Figure 6. Forward current vs. forward voltage.

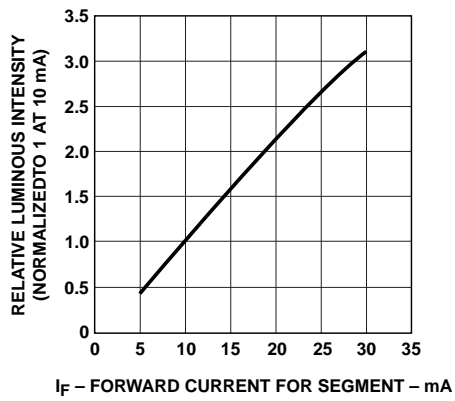

Figure 7. Relative luminous intensity vs. DC forward current.

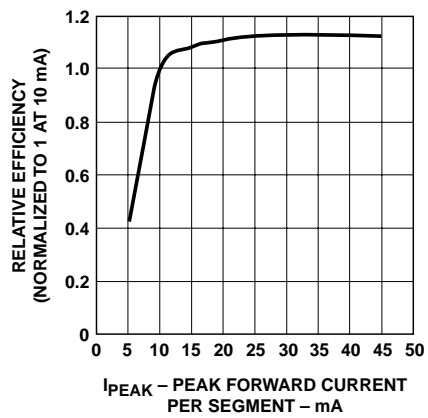

Figure 8. Relative efficiency (luminous intensity per unit current) vs. peak current.

AlGaAs Red

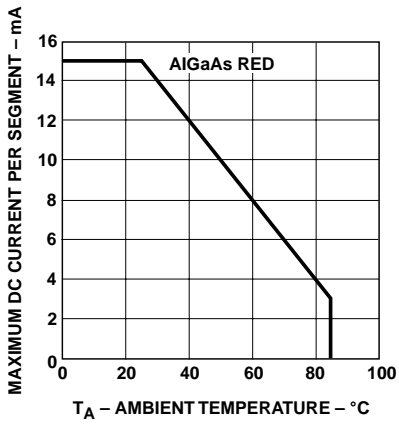

Figure 9. Maximum allowable average or DC current vs. ambient temperature.

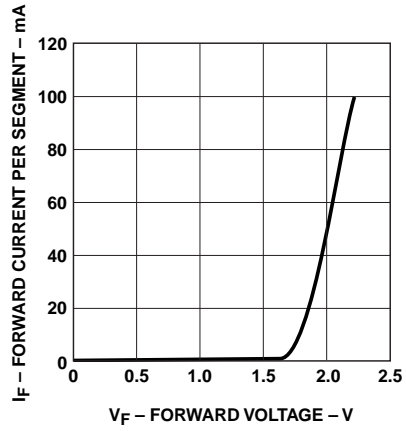

Figure 10. Forward current vs. forward voltage.

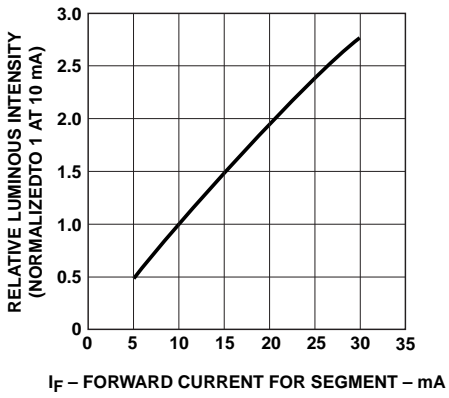

Figure 11. Relative luminous intensity vs. DC forward current.

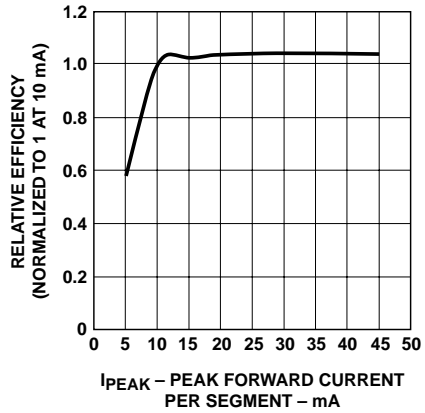

Figure 12. Relative efficiency (luminous intensity per unit current) vs. peak current.

Yellow

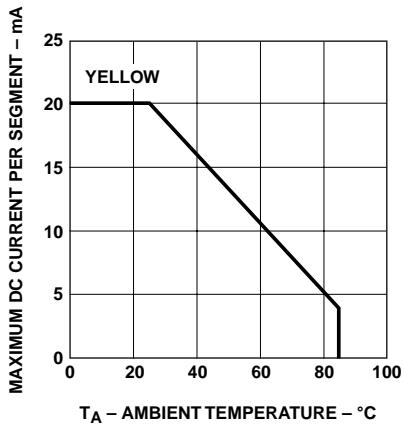

Figure 13. Maximum allowable average or DC current vs. ambient temperature.

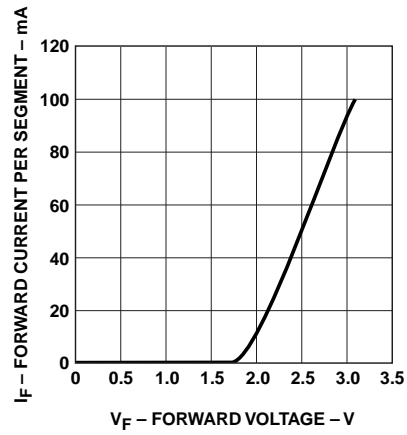

Figure 14. Forward current vs. forward voltage.

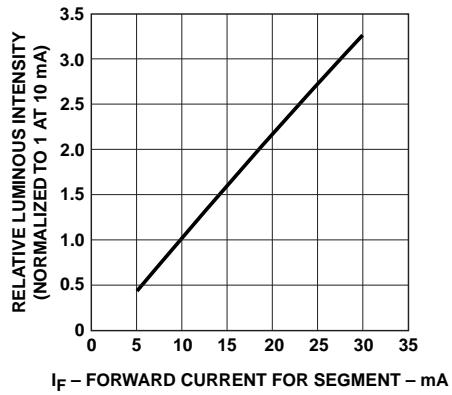

Figure 15. Relative luminous intensity vs. DC forward current.

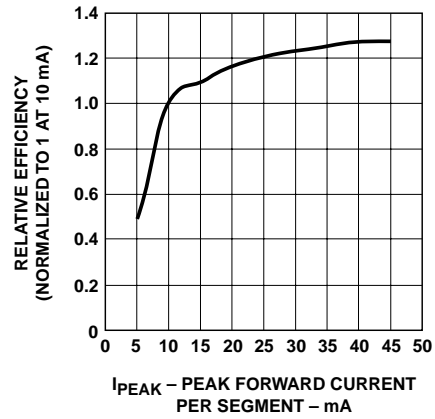

Figure 16. Relative efficiency (luminous intensity per unit current) vs. peak current.

For product information and a complete list of distributors, please go to our website: www.avagotech.com

Avago, Avago Technologies, and the A logo are trademarks of Avago Technologies Limited in the United States and other countries.
Data subject to change. Copyright © 2006 Avago Technologies Limited. All rights reserved. Obsoletes 5980-2919EN
5988-2968EN May 18, 2006

