

Agilent HLMP-4700 T-1^{3/4} (5 mm), T-1 (3 mm), Low Current LED Lamps Data Sheet

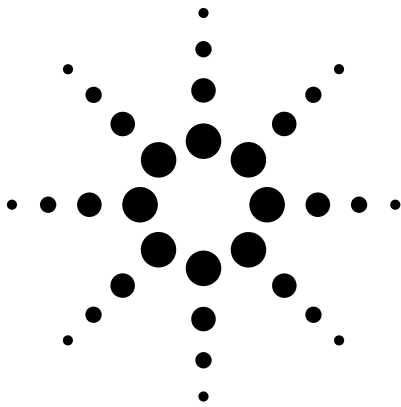

HLMP-4700, HLMP-4719, HLMP-4740
HLMP-1700, HLMP-1719, HLMP-1790

Description

These tinted diffused LED lamps are designed and optimized specifically for low DC current operation. Luminous intensity

and forward voltage are tested at 2 mA to assure consistent brightness at TTL output current levels.

Features

- Low power
- High efficiency
- CMOS-MOS compatible
- TTL compatible
- Wide viewing angle
- Choice of package styles
- Choice of colors

Applications

- Low power DC circuits
- Telecommunications indicators
- Portable equipment
- Keyboard indicators

Package Dimensions

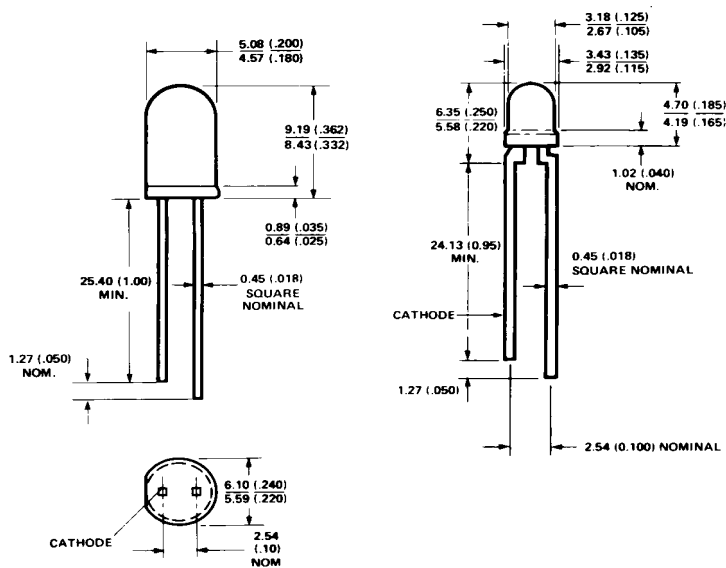

NOTES:

1. ALL DIMENSIONS ARE IN MILLIMETERS (INCHES).
2. AN EPOXY MINISCUS MAY EXTEND ABOUT 1 mm (0.040") DOWN THE LEADS.

HLMP-4700, -4719, -4740

A

HLMP-1700, -1719, -1790

B



Agilent Technologies

Selection Guide

| Package Description | Color | Device HLMP- | Luminous Intensity I _v (mcd) at 2 mA | | | 2θ ^{1/2} | Package Outline |
|-------------------------|---------------------|--------------|--|------|------|-------------------|--------------------|
| | | | Min. | Typ. | Max. | | |
| T-1 3/4 Tinted Diffused | Red | 4700 | 1.5 | 2.3 | – | 50 | A |
| | | 4700-C00xx | 1.5 | 2.3 | – | | |
| | | 4700-CD0FH | 1.5 | 2.3 | 4.2 | | |
| | Yellow | 4719 | 0.9 | 2.1 | – | | |
| | | 4719-A00xx | 0.9 | 2.1 | – | | |
| | Green | 4740 | 1.0 | 2.3 | – | | |
| | | 4740-A00xx | 1.0 | 2.3 | – | | |
| | | 4740-AB000 | 1.0 | 2.3 | 3.2 | | |
| | T-1 Tinted Diffused | Red | 1700 | 0.8 | 2.1 | | |
| 1700-B00xx | | | 0.8 | 2.1 | – | | |
| Yellow | | 1719 | 0.9 | 2.1 | – | | |
| | | 1719-A00xx | 0.9 | 2.1 | – | | |
| | | 1719-ABB00 | 0.9 | 2.1 | 2.8 | | |
| Green | | 1790 | 1.0 | 2.3 | – | | |
| | | 1790-A00xx | 1.0 | 2.3 | – | | |
| | | 1790-AB0FH | 1.0 | 2.4 | 3.2 | | |

Note:

1. θ^{1/2} is the typical off-axis angle at which the luminous intensity is half the axial luminous intensity.

Part Numbering System

HLMP-X 7 XX - X X X XX

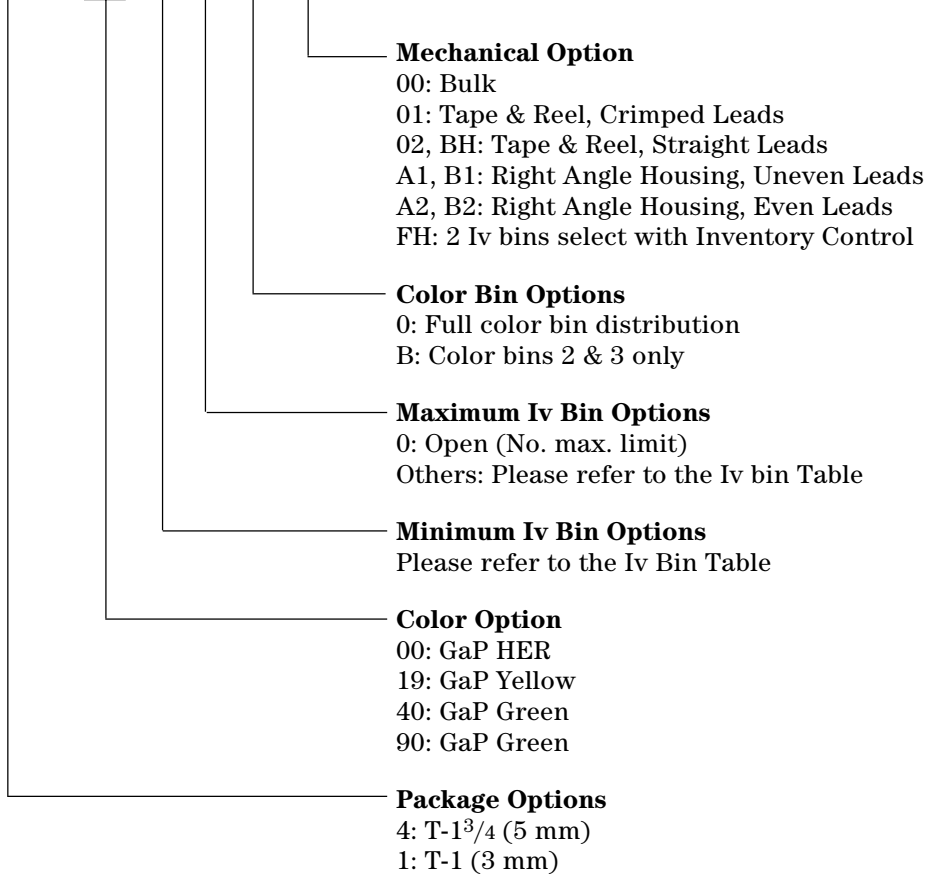

Electrical/Optical Characteristics at $T_A = 25^\circ\text{C}$

| Symbol | Description | T-1 ^{3/4} | T-1 | Min. | Typ. | Max. | Units | Test Conditions |
|-----------------------|---------------------------|--------------------|------|------|--------------------|------|-------------------------------------|-----------------------------------|
| V_F | Forward Voltage | 4700 | 1700 | | 1.7 | 2.0 | V | 2 mA |
| | | 4719 | 1719 | | 1.8 | 2.5 | | |
| | | 4740 | 1790 | | 1.9 | 2.2 | | |
| V_R | Reverse Breakdown Voltage | 4700 | 1700 | 5.0 | | | V | $I_R = 50 \mu\text{A}$ |
| | | 4719 | 1719 | 5.0 | | | | |
| | | 4740 | 1790 | 5.0 | | | | |
| λ_d | Dominant Wavelength | 4700 | 1700 | | 626 | | nm | Note 1 |
| | | 4719 | 1719 | | 585 | | | |
| | | 4740 | 1790 | | 569 | | | |
| $\Delta\lambda_{1/2}$ | Spectral Line Halfwidth | 4700 | 1700 | | 40 | | nm | |
| | | 4719 | 1719 | | 36 | | | |
| | | 4740 | 1790 | | 28 | | | |
| τ_S | Speed of Response | 4700 | 1700 | | 90 | | ns | |
| | | 4719 | 1719 | | 90 | | | |
| | | 4740 | 1790 | | 500 | | | |
| C | Capacitance | 4700 | 1700 | | 11 | | pF | $V_F = 0,$ $f = 1 \text{ MHz}$ |
| | | 4719 | 1719 | | 15 | | | |
| | | 4740 | 1790 | | 18 | | | |
| $R\theta_{J-PIN}$ | Thermal Resistance | 4700 | 1700 | | 260 ^[3] | | $^\circ\text{C/W}$ | Junction to Cathode Lead |
| | | 4719 | 1719 | | 290 ^[4] | | | |
| | | 4740 | 1790 | | | | | |
| λ_{PEAK} | Peak Wavelength | 4700 | 1700 | | 635 | | nm | Measurement at Peak |
| | | 4719 | 1719 | | 583 | | | |
| | | 4740 | 1790 | | 565 | | | |
| η_V | Luminous Efficacy | 4700 | 1700 | | 145 | | $\frac{\text{lumens}}{\text{watt}}$ | Note 2 |
| | | 4719 | 1719 | | 500 | | | |
| | | 4740 | 1790 | | 595 | | | |

Notes:

1. The dominant wavelength, λ_d , is derived from the CIE chromaticity diagram and represents the single wavelength which defines the color of the device.
2. The radiant intensity, I_e , in watts per steradian, may be found from the equation $I_e = I_V / \eta_V$, where I_V is the luminous intensity in candelas and η_V is luminous efficacy in lumens/watt.
3. T-1^{3/4}.
4. T-1.

Absolute Maximum Ratings

| Parameter | Maximum Rating | | Units |
|---|-----------------|----------------|-------|
| Power Dissipation (Derate linearly from 92°C at 1.0 mA/°C) | Red | 2 | mW |
| | Yellow | 36 | |
| | Green | 24 | |
| DC and Peak Forward Current | 7 | | mA |
| Transient Forward Current (10 μs Pulse) ^[1] | 500 | | mA |
| Reverse Voltage (I _R = 50 μA) | 5.0 | | V |
| Operating Temperature Range | Red/Yellow | -55°C to 100°C | |
| | Green | -20°C to 100°C | |
| Storage Temperature Range | -55°C to +100°C | | |

Note:

1. The transient peak current is the maximum non-recurring peak current the devices can withstand without damaging the LED die and wire bonds. It is not recommended that the device be operated at peak currents beyond the Absolute Maximum Peak Forward Current.

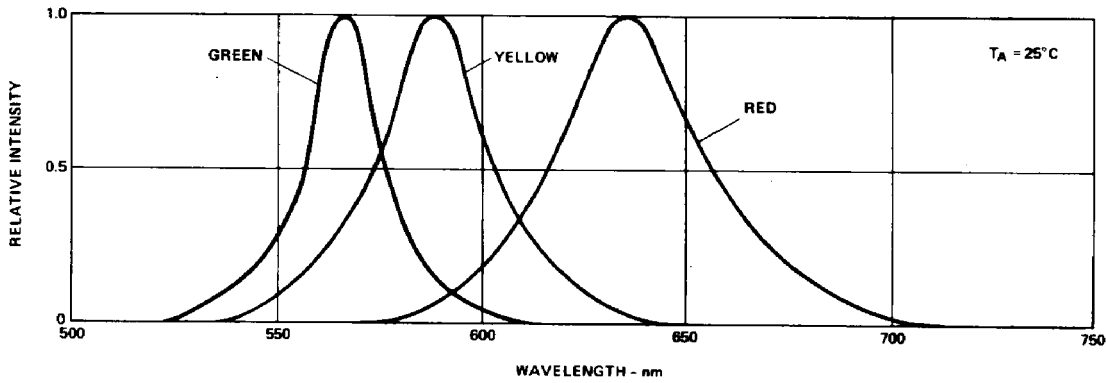

Figure 1. Relative intensity vs. wavelength.

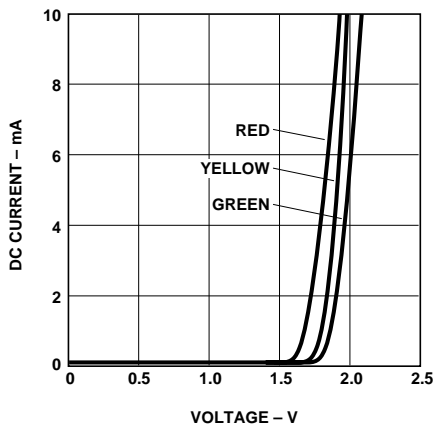

Figure 2. Forward current vs. forward voltage.

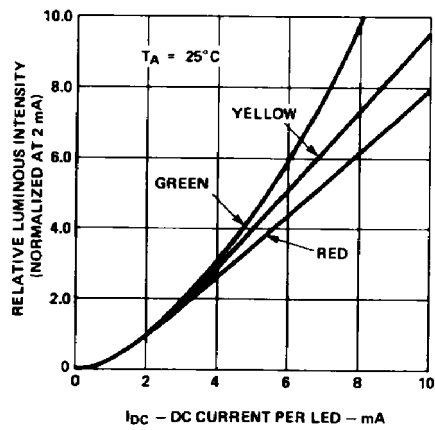

Figure 3. Relative luminous intensity vs. forward current.

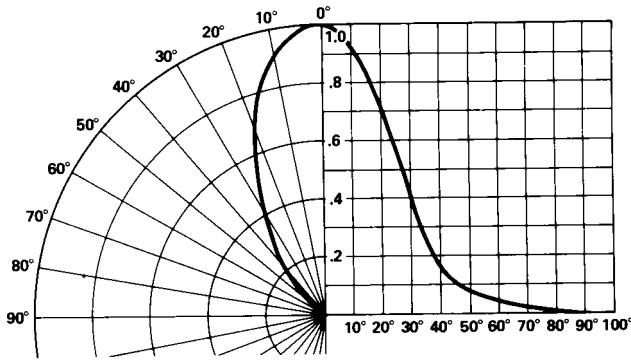

Figure 4. Relative luminous intensity vs. angular displacement for T-1^{3/4} lamp.

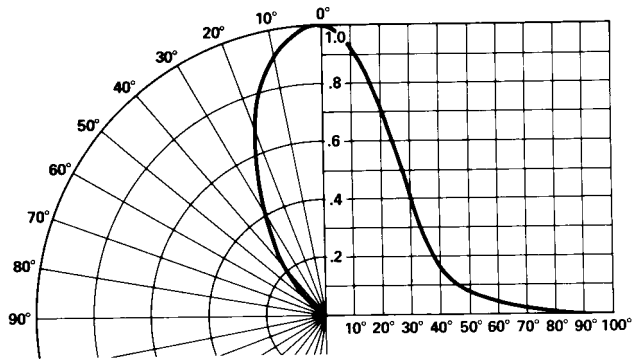

Figure 5. Relative Illuminous intensity vs. angular displacement for T-1 lamp.

Intensity Bin Limits

| Color | Bin | Intensity Range (mcd) | |
|-------|---------|-----------------------|--------|
| | | Min. | Max. |
| Red | B | 0.9 | 1.5 |
| | C | 1.5 | 2.4 |
| | D | 2.4 | 3.8 |
| | E | 3.8 | 6.1 |
| | F | 6.1 | 9.7 |
| | G | 9.7 | 15.5 |
| | H | 15.5 | 24.8 |
| | I | 24.8 | 39.6 |
| | J | 39.6 | 63.4 |
| | K | 63.4 | 101.5 |
| | L | 101.5 | 162.4 |
| | M | 162.4 | 234.6 |
| | N | 234.6 | 340.0 |
| | O | 340.0 | 540.0 |
| | P | 540.0 | 850.0 |
| | Q | 850.0 | 1200.0 |
| | R | 1200.0 | 1700.0 |
| | S | 1700.0 | 2400.0 |
| | T | 2400.0 | 3400.0 |
| | U | 3400.0 | 4900.0 |
| V | 4900.0 | 7100.0 | |
| W | 7100.0 | 10200.0 | |
| X | 10200.0 | 14800.0 | |
| Y | 14800.0 | 21400.0 | |
| Z | 21400.0 | 30900.0 | |

Maximum tolerance for each bin limit is ±18%.

Intensity Bin Limits, continued

| Color | Bin | Intensity Range (mcd) | |
|--------|---------|-----------------------|--------|
| | | Min. | Max. |
| Yellow | A | 1.0 | 1.6 |
| | B | 1.6 | 2.5 |
| | C | 2.5 | 4.0 |
| | D | 4.0 | 6.5 |
| | E | 6.5 | 10.3 |
| | F | 10.3 | 16.6 |
| | G | 16.6 | 26.5 |
| | H | 26.5 | 42.3 |
| | I | 42.3 | 67.7 |
| | J | 67.7 | 108.2 |
| | K | 108.2 | 173.2 |
| | L | 173.2 | 250.0 |
| | M | 250.0 | 360.0 |
| | N | 360.0 | 510.0 |
| | O | 510.0 | 800.0 |
| | P | 800.0 | 1250.0 |
| | Q | 1250.0 | 1800.0 |
| | R | 1800.0 | 2900.0 |
| S | 2900.0 | 4700.0 | |
| T | 4700.0 | 7200.0 | |
| U | 7200.0 | 11700.0 | |
| V | 11700.0 | 18000.0 | |
| W | 18000.0 | 27000.0 | |

Maximum tolerance for each bin limit is $\pm 18\%$.

Intensity Bin Limits, continued

| Color | Bin | Intensity Range (mcd) | |
|-------|---------|-----------------------|--------|
| | | Min. | Max. |
| Green | A | 1.1 | 1.8 |
| | B | 1.8 | 2.9 |
| | C | 2.9 | 4.7 |
| | D | 4.7 | 7.6 |
| | E | 7.6 | 12.0 |
| | F | 12.0 | 19.1 |
| | G | 19.1 | 30.7 |
| | H | 30.7 | 49.1 |
| | I | 49.1 | 78.5 |
| | J | 78.5 | 125.7 |
| | K | 125.7 | 201.1 |
| | L | 201.1 | 289.0 |
| | M | 289.0 | 417.0 |
| | N | 417.0 | 680.0 |
| | O | 680.0 | 1100.0 |
| | P | 1100.0 | 1800.0 |
| | Q | 1800.0 | 2700.0 |
| | R | 2700.0 | 4300.0 |
| | S | 4300.0 | 6800.0 |
| T | 6800.0 | 10800.0 | |
| U | 10800.0 | 16000.0 | |
| V | 16000.0 | 25000.0 | |
| W | 25000.0 | 40000.0 | |

Maximum tolerance for each bin limit is $\pm 18\%$.

Color Categories

| Color | Category # | Lambda (nm) | |
|--------|------------|-------------|-------|
| | | Min. | Max. |
| Green | 6 | 561.5 | 564.5 |
| | 5 | 564.5 | 567.5 |
| | 4 | 567.5 | 570.5 |
| | 3 | 570.5 | 573.5 |
| | 2 | 573.5 | 576.5 |
| Yellow | 1 | 582.0 | 584.5 |
| | 3 | 584.5 | 587.0 |
| | 2 | 587.0 | 589.5 |
| | 4 | 589.5 | 592.0 |
| | 5 | 592.0 | 593.0 |

Tolerance for each bin limit is ± 0.5 nm.

Mechanical Option Matrix

| Mechanical Option Code | Definition |
|------------------------|--|
| 00 | Bulk Packaging, minimum increment 500 pcs/bag |
| 01 | Tape & Reel, crimped leads, min. increment 1300 pcs/bag for T-1 3/4, 1800 pcs/bag for T-1 |
| 02 | Tape & Reel, straight leads, min. increment 1300 pcs/bag for T-1 3/4, 1800 pcs/bag for T-1 |
| A1 | T-1, Right Angle Housing, uneven leads, minimum increment 500 pcs/bag |
| A2 | T-1, Right Angle Housing, even leads, minimum increment 500 pcs/bag |
| B1 | T-1 3/4, Right Angle Housing, uneven leads, minimum increment 500 pcs/bag |
| B2 | T-1 3/4, Right Angle Housing, even leads, minimum increment 500 pcs/bag |
| BH | T-1, Tape & Reel, straight leads, minimum increment 2000 pcs/bag |
| FH | Devices that require inventory control and 2 I _v bin select |
| R1 | Tape & Reel, crimped leads, reeled counter clockwise, cathode lead leaving the reel first |

Note:

All categories are established for classification of products. Products may not be available in all categories. Please contact your local Agilent representative for further clarification/information.

Precautions

Lead Forming

- The leads of an LED lamp may be preformed or cut to length prior to insertion and soldering into PC board.
- If lead forming is required before soldering, care must be taken to avoid any excessive mechanical stress induced to LED package. Otherwise, cut the leads of LED to length after soldering process at room temperature. The solder joint formed will absorb the mechanical stress of the lead cutting from traveling to the LED chip die attach and wirebond.
- It is recommended that tooling made to precisely form and cut the leads to length rather than rely upon hand operation.

Soldering Conditions

- Care must be taken during PCB assembly and soldering process to prevent damage to LED component.
- The closest LED is allowed to solder on board is 1.59 mm below the body (encapsulant epoxy) for those parts without standoff.
- Recommended soldering conditions:

| | Wave Soldering | Manual Solder Dipping |
|----------------------|----------------|-----------------------|
| Pre-heat Temperature | 105 °C Max. | – |
| Pre-heat Time | 30 sec Max. | – |
| Peak Temperature | 250 °C Max. | 260 °C Max. |
| Dwell Time | 3 sec Max. | 5 sec Max. |

- Wave soldering parameter must be set and maintained according to recommended temperature and dwell time in the solder wave. Customer is advised to periodically check on the soldering profile to ensure the soldering profile used is always conforming to recommended soldering condition.
- If necessary, use fixture to hold the LED component in proper orientation with respect to the PCB during soldering process.
- Proper handling is imperative to avoid excessive thermal stresses to LED components when heated. Therefore, the soldered PCB must be allowed to cool to room temperature, 25°C, before handling.
- Special attention must be given to board fabrication, solder masking, surface plating and lead holes size and component orientation to assure solderability.
- Recommended PC board plated through hole sizes for LED component leads:

| LED Component Lead Size | Diagonal | Plated Through Hole Diameter |
|--|--------------------------|--|
| 0.457 x 0.457 mm (0.018 x 0.018 inch) | 0.646 mm (0.025 inch) | 0.976 to 1.078 mm (0.038 to 0.042 inch) |
| 0.508 x 0.508 mm (0.020 x 0.020 inch) | 0.718 mm (0.028 inch) | 1.049 to 1.150 mm (0.041 to 0.045 inch) |

Note: Refer to application note AN1027 for more information on soldering LED components.

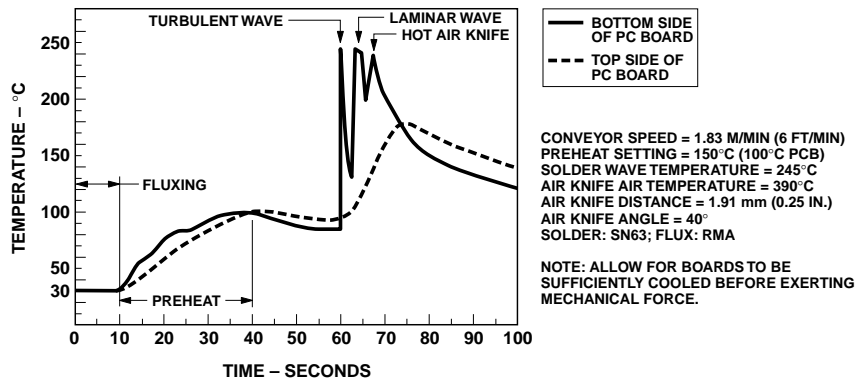

Figure 6. Recommended wave soldering profile.

www.agilent.com/semiconductors

For product information and a complete list of distributors, please go to our web site.

For technical assistance call:

Americas/Canada: +1 (800) 235-0312 or (916) 788-6763

Europe: +49 (0) 6441 92460

China: 10800 650 0017

Hong Kong: (+65) 6756 2394

India, Australia, New Zealand: (+65) 6755 1939

Japan: (+81 3) 3335-8152 (Domestic/International), or 0120-61-1280 (Domestic Only)

Korea: (+65) 6755 1989

Singapore, Malaysia, Vietnam, Thailand, Philippines, Indonesia: (+65) 6755 2044

Taiwan: (+65) 6755 1843

Data subject to change.

Copyright © 2005 Agilent Technologies, Inc.

Obsoletes 5989-2812EN

November 12, 2005

5989-4256EN



Agilent Technologies