

HLMP-PB00-N0000/HLMP-PM00-N0000
HLMP-QB00-S0000/HLMP-QM00-S0000
Subminiature Blue and Green InGaN LED Lamps



Data Sheet



Description

Flat Top Package

The HLMP-Pxxx flat top lamps use an untinted, nondiffused, truncated lens to provide a wide radiation pattern that is necessary for use in backlighting applications. The flat top lamps are also ideal for use as emitters in light pipe applications.

Dome Package

The HLMP-Qxxx dome lamps use an untinted, nondiffused lens to provide a high luminous intensity within a narrow radiation pattern.

Lead Configurations

All these devices are made by encapsulating LED chip on axial lead frames to form molded epoxy subminiature lamps. A variety of package configuration options is available. These include special surface mount lead configurations, gull wing, yoke lead, or Z-bend. Right angle lead bend at 2.54 mm (0.100 inch) and 5.08 mm (0.200 inch) center spacing are available for through hole mounting. For more information refer to Standard SMT and Through Hole Lead Bend Options for Subminiature Lamps data sheet.

Features

- Subminiature flat top package
Ideal for backlighting and light piping applications
- Subminiature dome package
Nondiffused dome for high brightness
- Colors: 468 nm blue, 525 nm green
- Ideal for space limited applications
- Axial leads
- Available with lead configurations for surface mount and through hole PC board mounting

Applications

- Consumer
- Industrial
- Computer peripheral
- Communication

CAUTION: HLMP-xB00 and HLMP-xM00 LEDs are Class 2 ESD sensitive. Please observe appropriate precautions during handling and processing. Refer to Avago Application Note AN-1142 for additional details.

Package Dimensions

(A) Flat Top Lamps

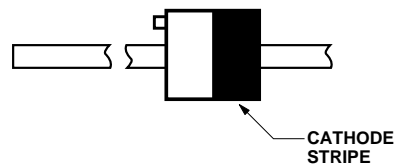
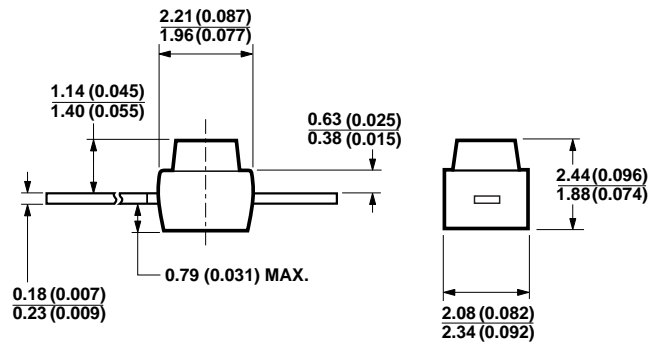
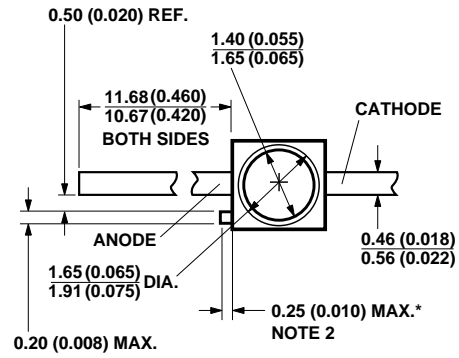

NOTES:

1. ALL DIMENSIONS ARE IN MILLIMETERS (INCHES).
2. PROTRUDING SUPPORT TAB IS CONNECTED TO CATHODE LEAD.

* REFER TO FIGURE 1 FOR DESIGN CONCERNS.

Package Dimensions

B) Domed Lamps

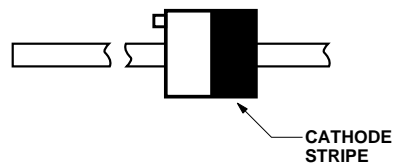
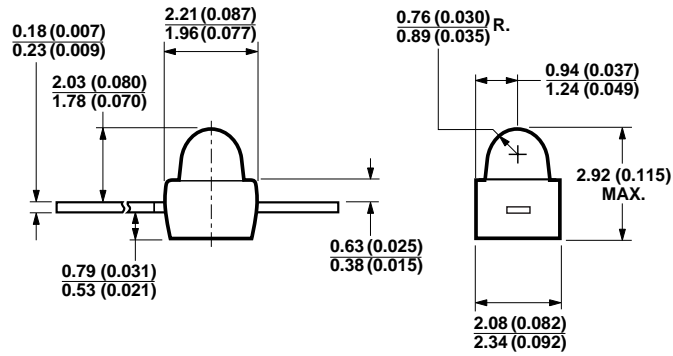
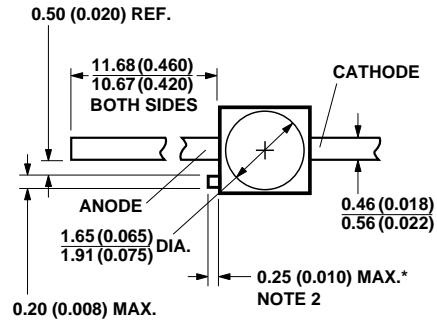

NOTES:

1. ALL DIMENSIONS ARE IN MILLIMETERS (INCHES).
2. PROTRUDING SUPPORT TAB IS CONNECTED TO CATHODE LEAD.

* REFER TO FIGURE 1 FOR DESIGN CONCERNS.

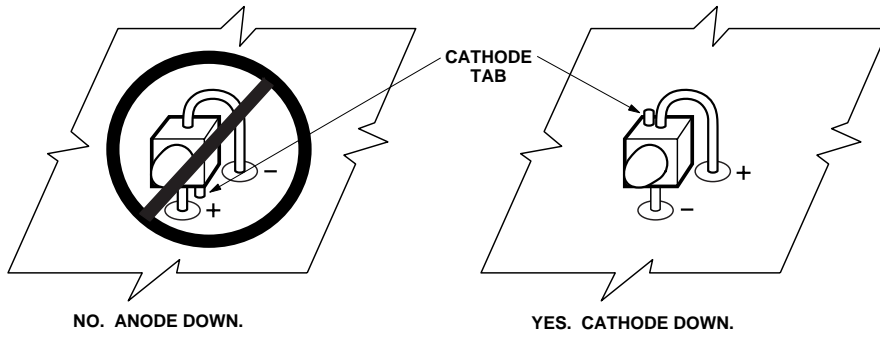
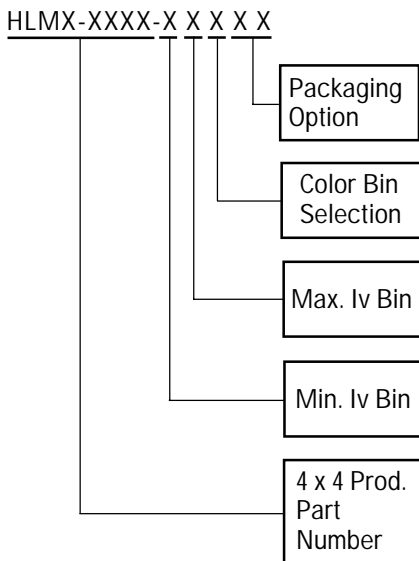

Figure 1. Proper right angle mounting to a PC board to prevent protruding cathode tab from shorting to anode connection.

Device Selection Guide

Part Number	Color	Viewing Angle $2\theta_{1/2}$	Package Description	Package Outline
HLMP-PB00-N0000	Blue	85°	Flat Top, Nondiffused, Untinted	A
HLMP-PM00-N0000	Green			
HLMP-QB00-S0000	Blue	20°	Domed, Nondiffused, Untinted	B
HLMP-QM00-S0000	Green			

Ordering Information



Absolute Maximum Ratings at T_A = 25°C

Parameter	Value
Peak Forward Current	90 mA
DC Forward Current ^[1]	30 mA
Power Dissipation	110 mW
Reverse Voltage (I _R = 10 μA)	5 V
Operating Temperature Range	-40°C to +85°C
Storage Temperature Range	-55°C to +100°C
LED Junction Temperature	110°C
Lead Soldering Temperature [1.6 mm (0.063 in.) from body]	260°C for 5 seconds
SMT Reflow Soldering Temperature	260°C for 20 seconds

Note:

1. Derate linearly as shown in Figure 5.

Optical Characteristics at T_A = 25°C

Part Number	Luminous Intensity I _v (mcd) @ I _F = 20 mA		Peak Wavelength λ _{PEAK} (nm)	Color, Dominant Wavelength λ _d (nm)	Spectral Halfwidth Δλ _{1/2} (nm)	Viewing Angle 2θ _{1/2} Degrees	Luminous Efficacy η _v (lm/W)
	Min.	Typ.	Typ.	Typ.	Typ.	Typ.	
HLMP-PB00-N0000	25	60	470	468	26	85	70
HLMP-PM00-N0000	25	200	523	525	36	85	500
HLMP-QB00-S0000	160	290	470	468	26	20	70
HLMP-QM00-S0000	160	690	523	525	36	20	500

Electrical Characteristics at T_A = 25°C

Part Number	Forward Voltage V _F (Volts) @ I _F = 20 mA		Reverse Breakdown V _R (Volts) @ I _R = 100 μA	Capacitance C (pF), V _F = 0, f = 1 MHz	Thermal Resistance R _{θJ-PIN} (°C/W)
	Typ.	Max.	Min.	Typ.	Typ.
HLMP-PB00-N0000	3.7	4.1	5	52	170
HLMP-PM00-N0000	3.7	4.1	5	52	170
HLMP-QB00-S0000	3.7	4.1	5	52	170
HLMP-QM00-S0000	3.7	4.1	5	52	170

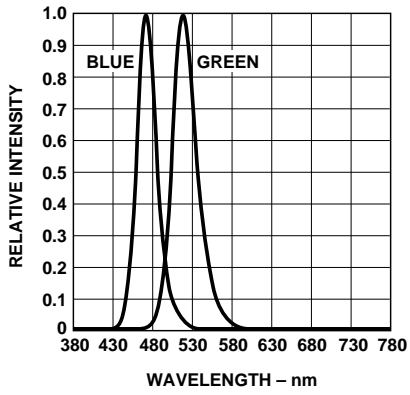

Figure 2. Relative intensity vs. wavelength.

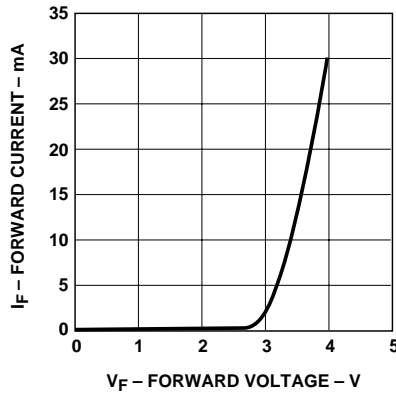

Figure 3. Forward current vs. forward voltage.

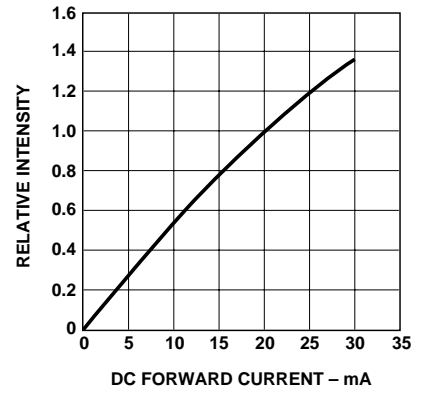

Figure 4. Relative luminous intensity vs. DC forward current.

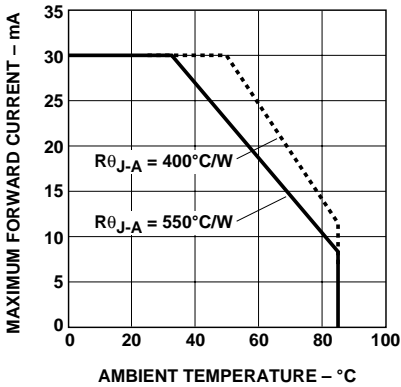

Figure 5. Maximum forward current vs. ambient temperature. Derating based on $T_{JMAX} = 110^{\circ}C$.

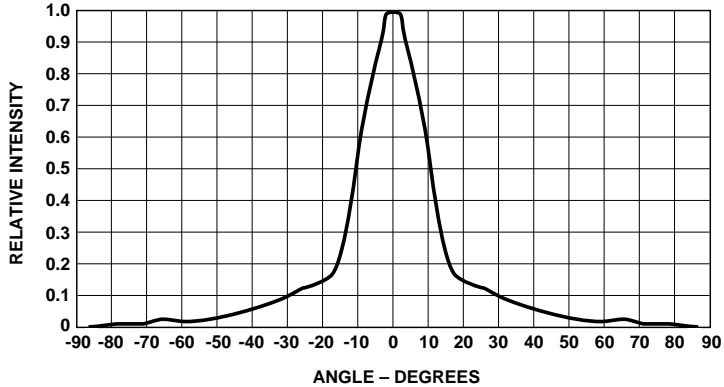

Figure 6. Relative luminous intensity vs. angular displacement for HLMP-Qxxx.

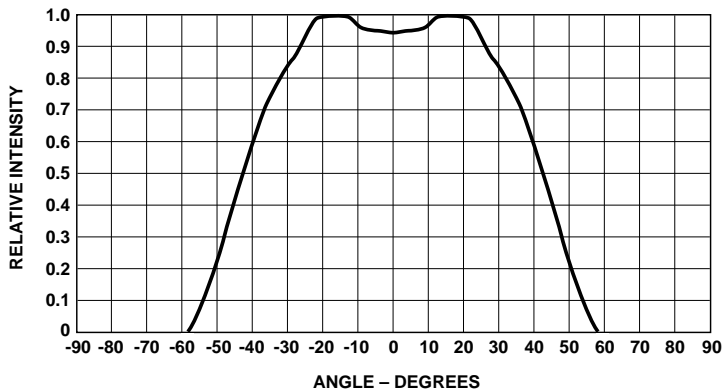

Figure 7. Relative luminous intensity vs. angular displacement for HLMP-Pxxx.

Intensity Bin limits

Bin	Min.	Max.
N	25	50
P	40	80
Q	63	125
R	100	200
S	160	320
T	250	500
U	400	800
V	630	1250
W	1000	2000
X	1600	3200
Y	2500	5000

Color Bin limits

Package	Bin	Min.	Max.
Blue	0	Full Distribution	
	1	460	464
	2	464	468
	3	468	472
	4	472	476
	5	476	480
Green	6	480	484
	0	Full Distribution	
	3	520	525
	4	525	530
	5	530	535
	6	535	540

Tolerance of each bin limit = ± 2 nm.

Mechanical Option

00	Straight Leads, Bulk Packaging, Quantity of 500 Parts
11	Gull Wing Leads, 12 mm Tape on 7 in. Dia. Reel, 1500 Parts per Reel
12	Gull Wing Lead, Bulk Packaging, Quantity of 500 Parts
14	Gull Wing Leads, 12 mm Tape on 13 in. Dia. Reel, 6000 Parts per Reel
21	Yoke Leads, 12 mm Tape on 7 in. Dia. Reel, 1500 Parts per Reel
22	Yoke Leads, Bulk Packaging, Quantity of 500 Parts
24	Yoke Leads, 12 mm Tape on 13 in. Dia. Reel, 6000 Parts per Reel
31	Z-Bend Leads, 12 mm Tape on 7 in. Dia. Reel, 1500 Parts per Reel
32	Z-Bend Leads, Bulk Packaging, Quantity of 500 Parts
34	Z-Bend Leads, 12 mm Tape on 13 in. Dia. Reel, 6000 Parts per Reel

Note:

All Categories are established for classification of products. Products may not be available in all categories. Please contact your local Avago representative for further clarification/information.

For product information and a complete list of distributors, please go to our website: www.avagotech.com

Avago, Avago Technologies, and the A logo are trademarks of Avago Technologies, Pte. in the United States and other countries.
Data subject to change. Copyright © 2006 Avago Technologies Pte. All rights reserved. Obsoletes 5989-1710EN
AV01-0472EN Semptember 14, 2006

