

ACPL-P302/W302

0.4 Amp Output Current IGBT Gate Driver Optocouplers



Data Sheet



Lead (Pb) Free
RoHS 6 fully compliant

RoHS 6 fully compliant options available;
-xxxE denotes a lead-free product

Description

The ACPL-P302/W302 consists of a GaAsP LED optically coupled to an integrated circuit with a power output stage. These optocouplers are ideally suited for driving power IGBTs and MOSFETs used in motor control inverter applications. The high operating voltage range of the output stage provides the drive voltages required by gate controlled devices. The voltage and current supplied by this optocoupler makes it ideally suited for directly driving small or medium power IGBTs.

Applications

- Isolated IGBT/Power MOSFET gate drive
- AC and brushless DC motor drives
- Industrial inverters
- Inverter for home appliances
- Induction cooker
- Switching Power Supplies (SPS)

Functional Diagram

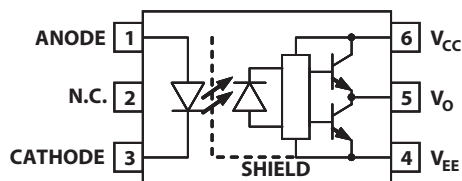

| Truth Table | |
|-------------|------|
| LED | VO |
| OFF | LOW |
| ON | HIGH |

Note: A 0.1 μ F bypass capacitor must be connected between pins V_{CC} and V_{EE} .

Features

- High speed response.
- Ultra high CMR.
- Bootstrappable supply current.
- Available in Stretched SO-6 package
- Package Clearance/Creepage at 8mm (ACPL-W302)
- Safety Approval:
UL Recognized with 3750 V_{rms} for 1 minute per UL1577.
CSA Approved.
IEC/EN/DIN EN 60747-5-2 Approved with $V_{IORM} = 630V_{peak}$ for option 060.

Specifications

- 0.4 A maximum peak output current.
- 0.2 A minimum peak output current.
- 0.7 μ s maximum propagation delay over temperature range.
- $I_{CC(max)} = 3$ mA maximum supply current.
- 10 kV/ μ s minimum common mode rejection (CMR) at $V_{CM} = 1000$ V.
- Wide V_{CC} operating range: 10 V to 30 V over temperature range.
- Wide operating temperature range: $-40^{\circ}C$ to $100^{\circ}C$.



CAUTION: IT IS ADVISED THAT NORMAL STATIC PRECAUTIONS BE TAKEN IN HANDLING AND ASSEMBLY OF THIS COMPONENT TO PREVENT DAMAGE AND/OR DEGRADATION WHICH MAY BE INDUCED BY ESD.

Ordering Information

ACPL-P302 and ACPL-W302 are UL Recognized with 3750 Vrms for 1 minute per UL1577.

| Part number | Option | | Surface Mount | Tape & Reel | IEC/EN/DIN EN 60747-5-2 | Quantity |
|------------------------|----------------|----------------|---------------|-------------|-------------------------|---------------|
| | RoHS Compliant | Package | | | | |
| ACPL-P314 ACPL-W314 | -000E | Stretched SO-6 | X | | | 100 per tube |
| | -500E | | X | X | | 1000 per reel |
| | -060E | | X | | X | 100 per tube |
| | -560E | | X | X | X | 1000 per reel |

To order, choose a part number from the part number column and combine with the desired option from the option column to form an order entry.

Example 1:

ACPL-P302-560E to order product of Stretched SO-6 Surface Mount package in Tape and Reel packaging with IEC/EN/DIN EN 60747-5-2 Safety Approval in RoHS compliant.

Example 2:

ACPL-P302-000E to order product of Stretched SO-6 Surface Mount package in tube packaging and RoHS compliant.

Option datasheets are available. Contact your Avago sales representative or authorized distributor for information.

Remarks: The notation '#XXX' is used for existing products, while (new) products launched since 15th July 2001 and RoHS compliant option will use '-XXxE'.

Package Outline Drawings

ACPL-P302 Stretched SO-6 Package, 7mm clearance

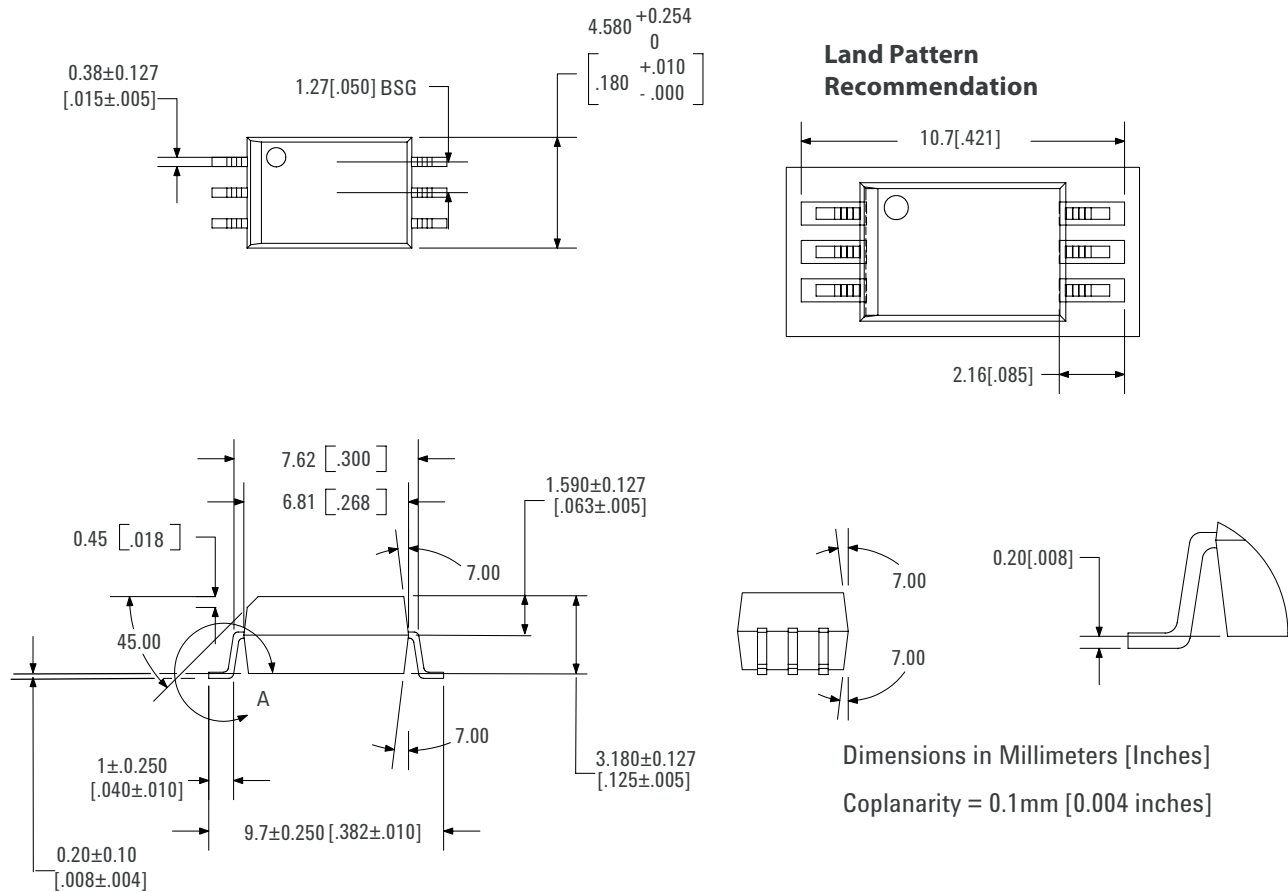

ACPL-W302 Stretched SO-6 Package

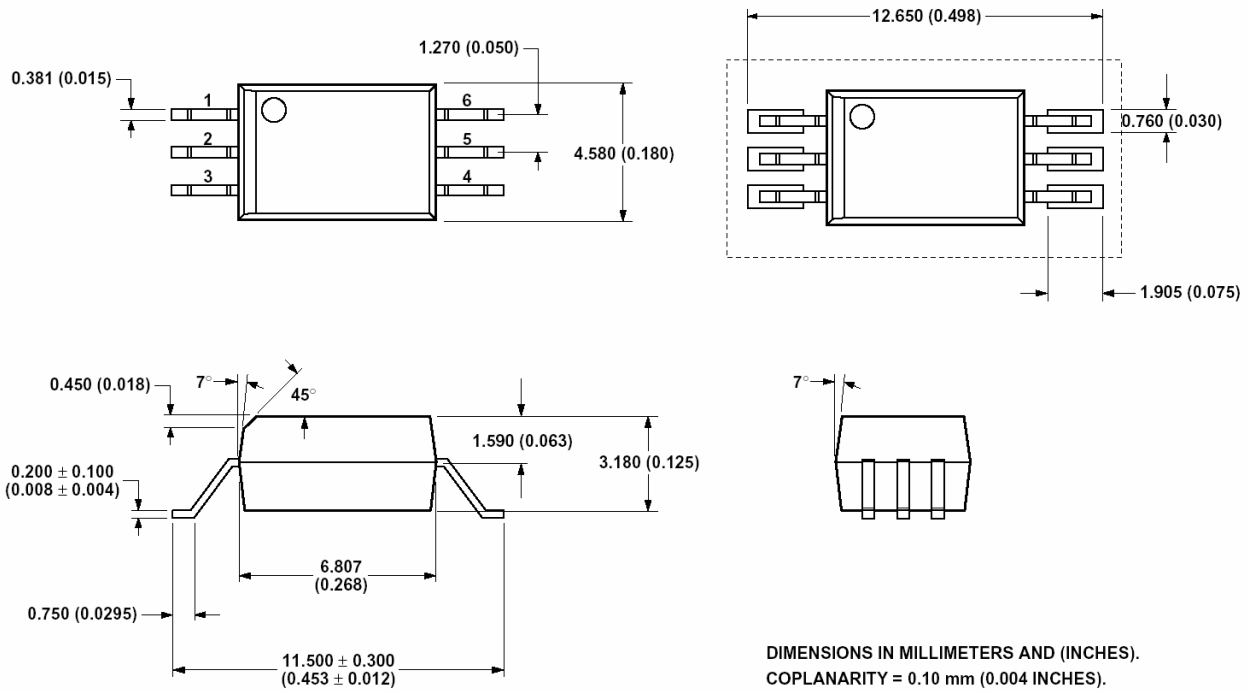

Recommended Solder Reflow Temperature Profile

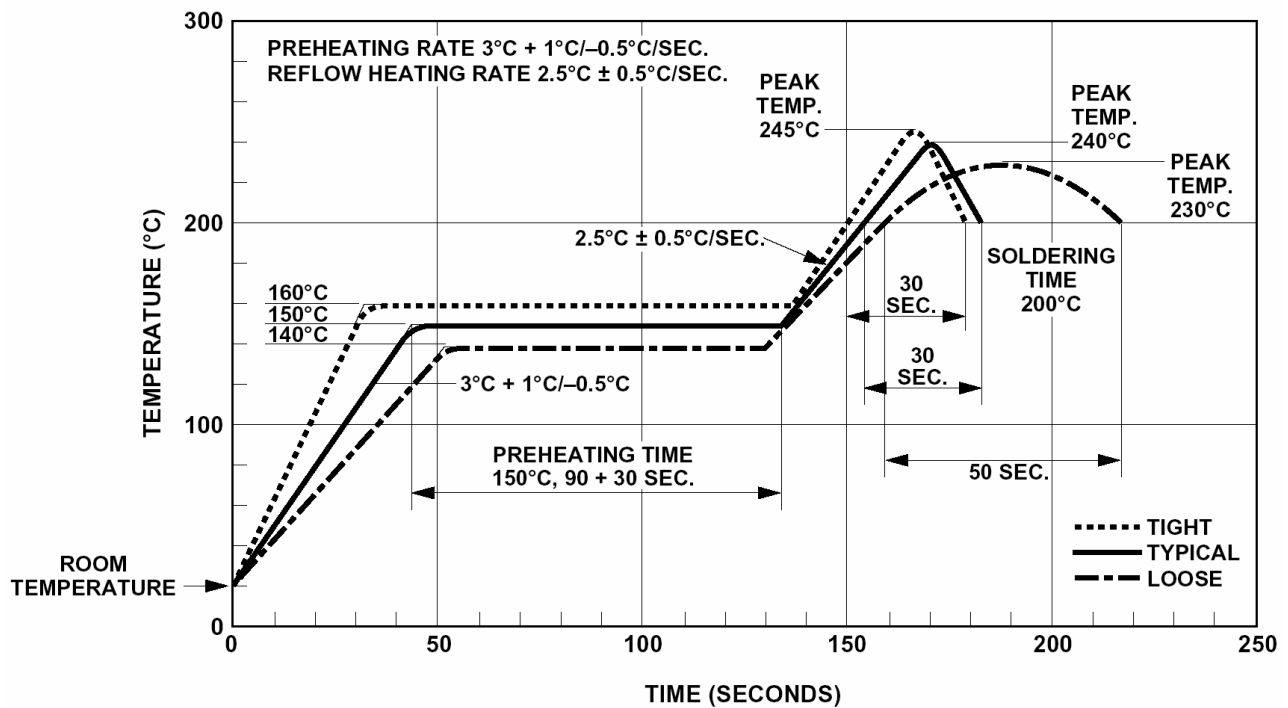

Note: Non-halide flux should be used

Recommended Pb-Free IR Profile

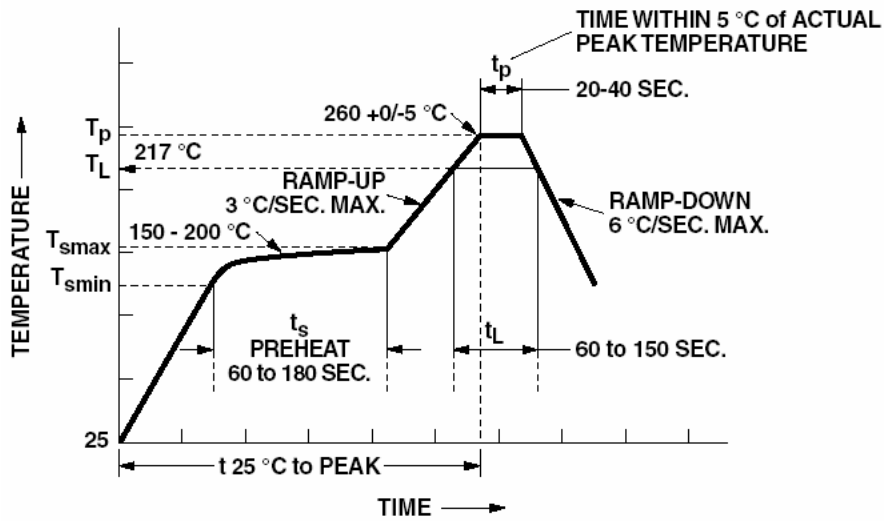

NOTES:

THE TIME FROM 25 °C to PEAK TEMPERATURE = 8 MINUTES MAX.

$T_{smax} = 200$ °C, $T_{smin} = 150$ °C

Note: Non-halide flux should be used

Regulatory Information

The ACPL-P302/W302 is pending approval by the following organizations:

IEC/EN/DIN EN 60747-5-2 (Option 060 only)

Approval under:

IEC 60747-5-2 :1997 + A1:2002

EN 60747-5-2:2001 + A1:2002

DIN EN 60747-5-2 (VDE 0884 Teil 2):2003-01

UL

Approval under UL 1577, component recognition program up to $V_{ISO} = 3750 V_{RMS}$. File E55361.

CSA

Approval under CSA Component Acceptance Notice #5, File CA 88324.

Table 1. IEC/EN/DIN EN 60747-5-2 Insulation Characteristics* (ACPL-P302/W302 Option 060)

| Description | Symbol | Characteristic | Unit |
|---|---------------|-----------------------------|-------------|
| Installation classification per DIN VDE 0110/1.89, Table 1 for rated mains voltage $\leq 150V_{rms}$ for rated mains voltage $\leq 300V_{rms}$ for rated mains voltage $\leq 600V_{rms}$ | | I - IV I - III I - II | |
| Climatic Classification | | 55/100/21 | |
| Pollution Degree (DIN VDE 0110/1.89) | | 2 | |
| Maximum Working Insulation Voltage | V_{IORM} | 630 | V_{peak} |
| Input to Output Test Voltage, Method b* $V_{IORM} \times 1.875 = V_{PR}$, 100% Production Test with $t_m = 1$ sec, Partial discharge < 5 pC | V_{PR} | 1181 | V_{peak} |
| Input to Output Test Voltage, Method a* $V_{IORM} \times 1.5 = V_{PR}$, Type and Sample Test, $t_m = 60$ sec, Partial discharge < 5 pC | V_{PR} | 945 | V_{peak} |
| Highest Allowable Overvoltage (Transient Overvoltage $t_{ini} = 10$ sec) | V_{IOTM} | 6000 | V_{peak} |
| Safety-limiting values - maximum values allowed in the event of a failure. | | | |
| Case Temperature | T_S | 175 | $^{\circ}C$ |
| Input Current** | $I_S, INPUT$ | 230 | mA |
| Output Power*** | $P_S, OUTPUT$ | 600 | mW |
| Insulation Resistance at T_S , $V_{IO} = 500$ V | R_S | $> 10^9$ | |

* Refer to the optocoupler section of the Isolation and Control Components Designer's Catalog, under Product Safety Regulations section, (IEC/EN/DIN EN 60747-5-2) for a detailed description of Method a and Method b partial discharge test profiles.

** Refer to the following figure for dependence of P_S and I_S on ambient temperature.

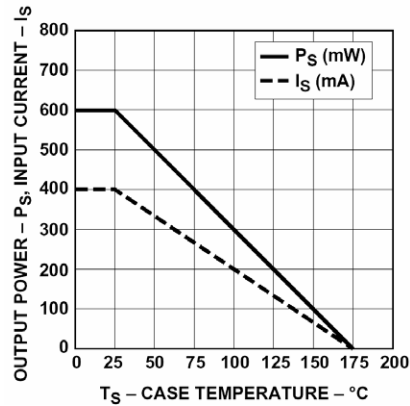

Table 2. Insulation and Safety Related Specifications

| Parameter | Symbol | ACPL-P302 | ACPL-W302 | Units | Conditions |
|---|--------|-----------|-----------|-------|--|
| Minimum External Air Gap (External Clearance) | L(101) | 7.0 | 8.0 | mm | Measured from input terminals to output terminals, shortest distance through air. |
| Minimum External Tracking (External Creepage) | L(102) | 8.0 | 8.0 | mm | Measured from input terminals to output terminals, shortest distance path along body. |
| Minimum Internal Plastic Gap (Internal Clearance) | | 0.08 | 0.08 | mm | Through insulation distance conductor to conductor, usually the straight line distance thickness between the emitter and detector. |
| Minimum Internal Tracking (Internal Creepage) | | NA | NA | mm | Measured from input terminals to output terminals, along internal cavity. |
| Tracking Resistance (Comparative Tracking Index) | CTI | > 175 | > 175 | V | DIN IEC 112/VDE 0303 Part 1 |
| Isolation Group | | IIIa | IIIa | | Material Group (DIN VDE 0110, 1/89, Table 1) |

Table 3. Absolute Maximum Ratings

| Parameter | Symbol | Min. | Max. | Units | Note |
|---|---|------|-----------------|-------|------|
| Storage Temperature | T _S | -55 | 125 | °C | |
| Operating Temperature | T _A | -40 | 100 | °C | |
| Average Input Current | I _{F(AVG)} | | 25 | mA | 1 |
| Peak Transient Input Current(<1 μs pulse width, 300pps) | I _{F(TRAN)} | | 1.0 | A | |
| Reverse Input Voltage | V _R | | 5 | V | |
| “High” Peak Output Current | I _{OH(PEAK)} | | 0.4 | A | 2 |
| “Low” Peak Output Current | I _{OL(PEAK)} | | 0.4 | A | 2 |
| Supply Voltage | V _{CC} - V _{EE} | -0.5 | 35 | V | |
| Output Voltage | V _{O(PEAK)} | -0.5 | V _{CC} | V | |
| Output Power Dissipation | P _O | | 250 | mW | 3 |
| Input Power Dissipation | P _I | | 45 | mW | 4 |
| Lead Solder Temperature | 260°C for 10 sec., 1.6 mm below seating plane | | | | |
| Solder Reflow Temperature Profile | See Package Outline Drawings section | | | | |

Table 4. Recommended Operating Conditions

| Parameter | Symbol | Min. | Max. | Units | Note |
|-----------------------|-----------------------------------|------|------|-------|------|
| Power Supply | V _{CC} - V _{EE} | 10 | 30 | V | |
| Input Current (ON) | I _{F(ON)} | 7 | 12 | mA | |
| Input Voltage (OFF) | V _{F(OFF)} | -3.6 | 0.8 | V | |
| Operating Temperature | T _A | -40 | 100 | °C | |

Table 5. Electrical Specifications (DC)

Over recommended operating conditions unless otherwise specified.

| Parameter | Symbol | Min. | Typ. | Max. | Units | Test Conditions | Fig. | Note |
|---|----------------------------------|--------------------|----------------------|------|-------|---|-------|------|
| High Level Output Current | I _{OH} | 0.15 | | | A | V _O = V _{CC} - 4 | | 5 |
| | | 0.2 | 0.3 | | A | V _O = V _{CC} - 10 | 2 | 2 |
| Low Level Output Current | I _{OL} | 0.15 | | | A | V _O = V _{EE} + 2.5 | | 5 |
| | | 0.2 | 0.3 | | A | V _O = V _{EE} + 10 | 4 | 2 |
| High Level Output Voltage | V _{OH} | V _{CC} -4 | V _{CC} -1.8 | | V | I _O = -100 mA | 1 | 6, 7 |
| Low Level Output Voltage | V _{OL} | | 0.4 | 1 | V | I _O = 100 mA | 3 | |
| High Level Supply Current | I _{CCH} | | 0.7 | 3 | mA | I _O = 0 mA | 5, 6 | 14 |
| Low Level Supply Current | I _{CCL} | | 1.2 | 3 | mA | I _O = 0 mA | 5, 6 | 14 |
| Threshold Input Current Low to High | I _{FLH} | | | 6 | mA | I _O = 0 mA, V _O > 5 V | 7, 13 | |
| Threshold Input Voltage High to Low | V _{FHL} | 0.8 | | | V | I _O = 0 mA, V _O > 5 V | | |
| Input Forward Voltage | V _F | 1.2 | 1.5 | 1.8 | V | I _F = 10 mA | 14 | |
| Temperature Coefficient of Input Forward Voltage | ΔV _F /ΔT _A | | -1.6 | | mV/°C | I _F = 10 mA | | |
| Input Reverse Breakdown Voltage | BV _R | 5 | | | V | I _R = 10 μA | | |
| Input Capacitance | C _{IN} | | 60 | | pF | f = 1 MHz, V _F = 0 V | | |

Table 6. Switching Specifications (AC)

Over recommended operating conditions unless otherwise specified.

| Parameter | Symbol | Min. | Typ. | Max. | Units | Test Conditions | Fig. | Note |
|--|-----------|------|------|------|-------------------|--|----------------------------|------|
| Propagation Delay Time to High Output Level | t_{PLH} | 0.1 | 0.2 | 0.7 | μs | $R_g = 75\Omega$, $C_g = 1.5\text{ nF}$, $f = 10\text{ kHz}$, Duty Cycle = 50%, $I_F = 7\text{ mA}$, $V_{CC} = 30\text{ V}$ | 8, 9, 10, 11, 12, 15 | 13 |
| Propagation Delay Time to Low Output Level | t_{PHL} | 0.1 | 0.3 | 0.7 | μs | | | 13 |
| Propagation Delay Difference Between Any Two Parts or Channels | PDD | -0.5 | | 0.5 | μs | | | 10 |
| Rise Time | t_R | | 50 | | ns | | | |
| Fall Time | t_F | | 50 | | ns | | | |
| Output High Level Common Mode Transient Immunity | $ CM_H $ | 10 | | | kV/ μs | $T_A = 25^\circ\text{C}$, $V_{CM} = 1000\text{ V}$ | 16 | 11 |
| Output Low Level Common Mode Transient Immunity | $ CM_L $ | 10 | | | kV/ μs | | | 16 |

Table 7. Package Characteristics

| Parameter | Symbol | Min. | Typ. | Max. | Units | Test Conditions | Fig. | Note |
|--|-----------|------|-----------|------|-----------|--|------|------|
| Input-Output Momentary Withstand Voltage | V_{ISO} | 3750 | | | V_{rms} | $T_A = 25^\circ\text{C}$, $RH < 50\%$ for 1 min. | | 8, 9 |
| Input-Output Resistance | R_{I-O} | | 10^{12} | | | $V_{I-O} = 500\text{ V}$ | | 9 |
| Input-Output Capacitance | C_{I-O} | | 0.6 | | pF | Freq=1 MHz | | |

Notes:

- Derate linearly above 70°C free air temperature at a rate of 0.3 mA/°C.
- Maximum pulse width = 10 μs , maximum duty cycle = 0.2%. This value is intended to allow for component tolerances for designs with I_O peak minimum = 0.2 A. See Application section for additional details on limiting I_{OL} peak.
- Derate linearly above 85°C, free air temperature at the rate of 4.0 mW/°C.
- Input power dissipation does not require derating.
- Maximum pulse width = 50 μs , maximum duty cycle = 0.5%.
- In this test, V_{OH} is measured with a DC load current. When driving capacitive load V_{OH} will approach V_{CC} as I_{OH} approaches zero amps.
- Maximum pulse width = 1 ms, maximum duty cycle = 20%.
- In accordance with UL 1577, each optocoupler is proof tested by applying an insulation test voltage > 4500 V_{rms} for 1 second (leakage detection current limit $I_{I-O} < 5\ \mu\text{A}$). This test is performed before 100% production test for partial discharge (method B) shown in the IEC/EN/DIN EN 60747-5-2 Insulation Characteristics Table, if applicable.
- Device considered a two-terminal device: pins on input side shorted together and pins on output side shorted together.
- PDD is the difference between t_{PHL} and t_{PLH} between any two parts or channels under the same test conditions.
- Common mode transient immunity in the high state is the maximum tolerable $|dV_{CM}/dt|$ of the common mode pulse V_{CM} to assure that the output will remain in the high state (i.e. $V_O > 6.0\text{ V}$).
- Common mode transient immunity in a low state is the maximum tolerable $|dV_{CM}/dt|$ of the common mode pulse, V_{CM} , to assure that the output will remain in a low state (i.e. $V_O < 1.0\text{ V}$).
- This load condition approximates the gate load of a 1200 V/20 A IGBT.
- The power supply current increases when operating frequency and Q_g of the driven IGBT increases.

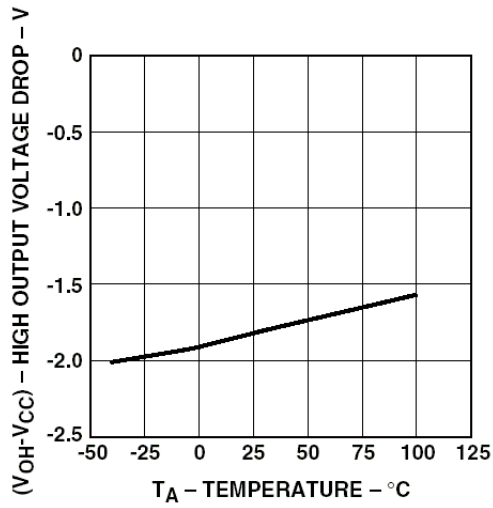

Figure 1. V_{OH} vs. Temperature.

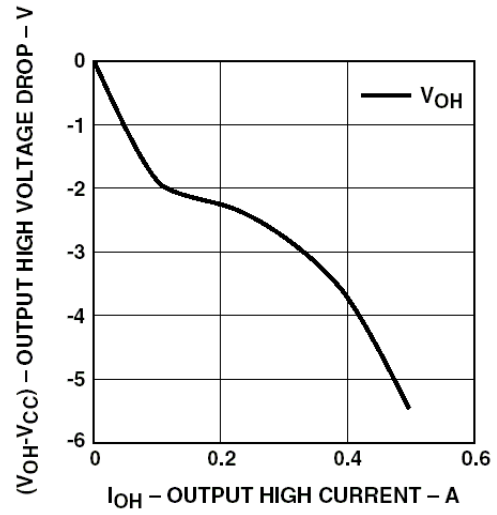

Figure 2. V_{OH} vs. I_{OH} .

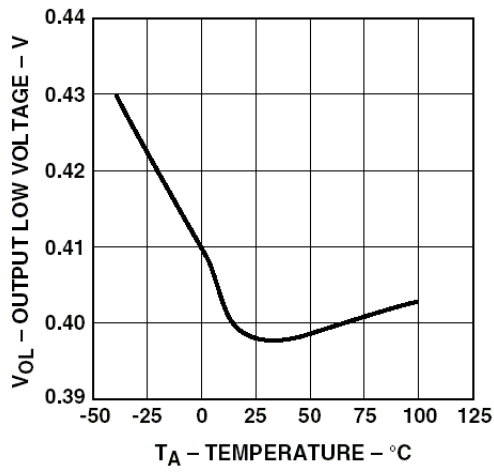

Figure 3. V_{OL} vs. Temperature.

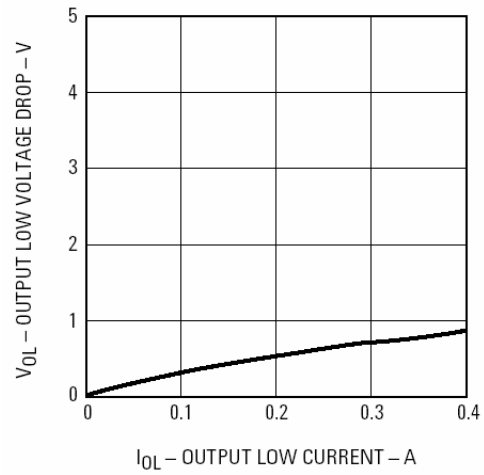

Figure 4. V_{OL} vs. I_{OL} .

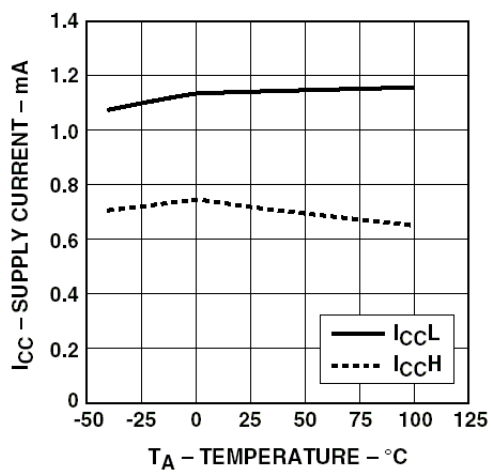

Figure 5. I_{CC} vs. Temperature.

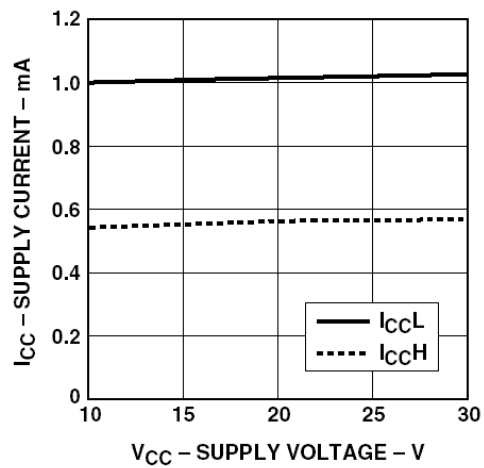

Figure 6. I_{CC} vs. V_{CC} .

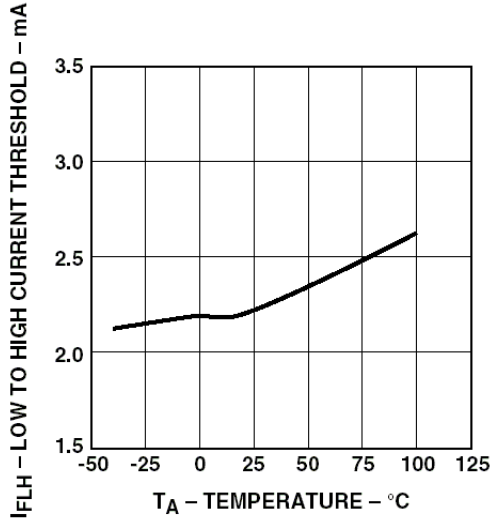

Figure 7. I_{FLH} vs. Temperature.

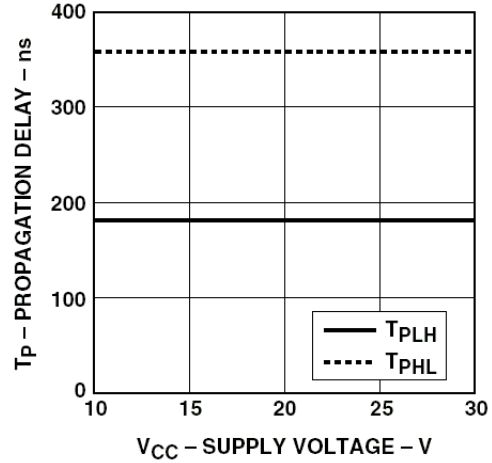

Figure 8. Propagation delay vs. V_{CC}.

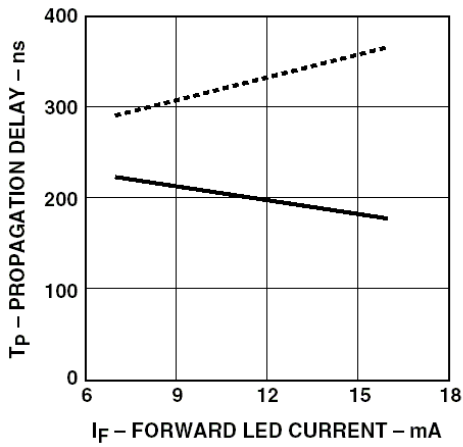

Figure 9. Propagation Delay vs. I_F.

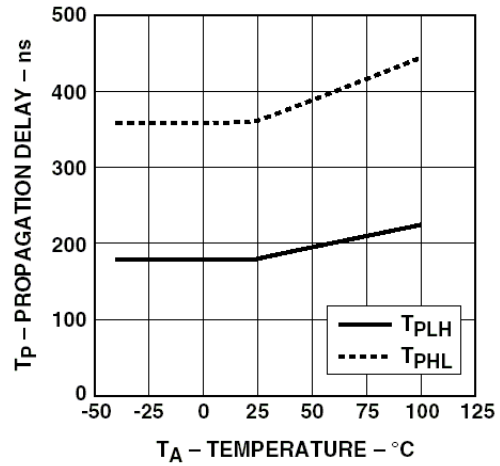

Figure 10. Propagation Delay vs. Temperature.

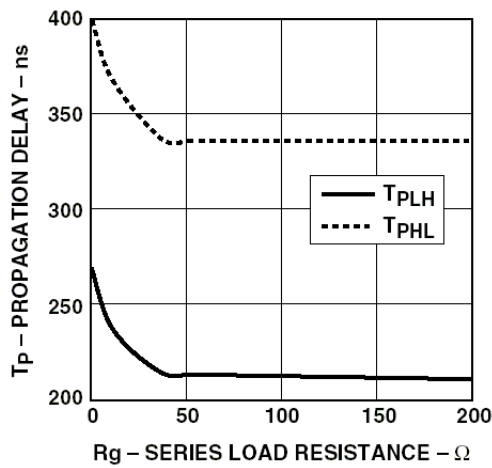

Figure 11. Propagation Delay vs. R_g.

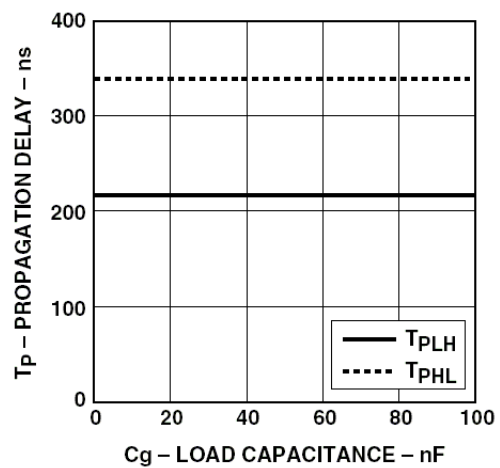

Figure 12. Propagation Delay vs. C_g.

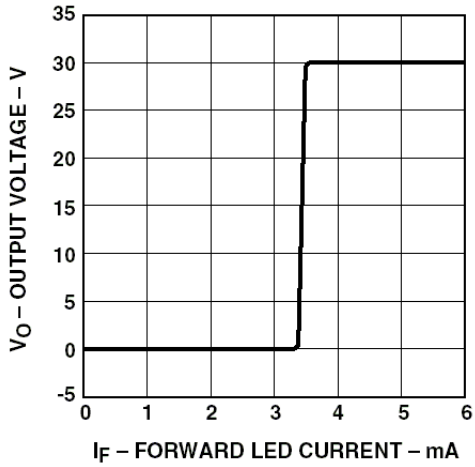

Figure 13. Transfer characteristics.

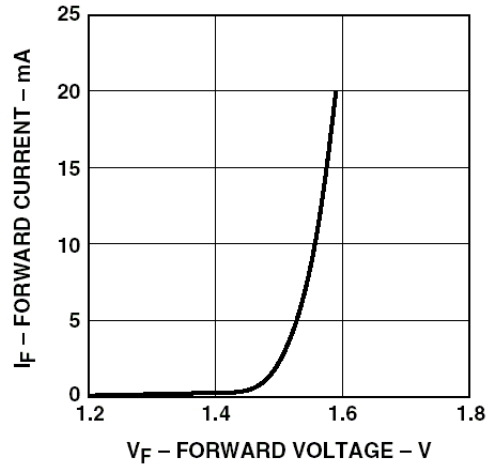

Figure 14. Input Current vs. Forward Voltage.

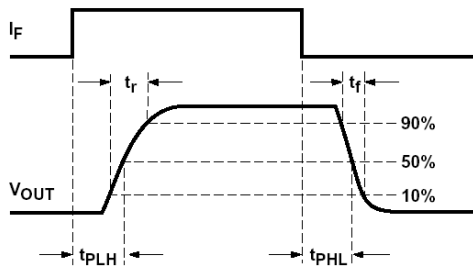
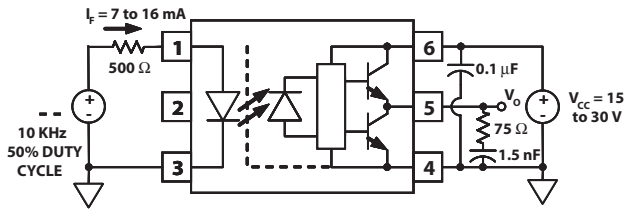

Figure 15. Propagation Delay Test Circuit and Waveforms.

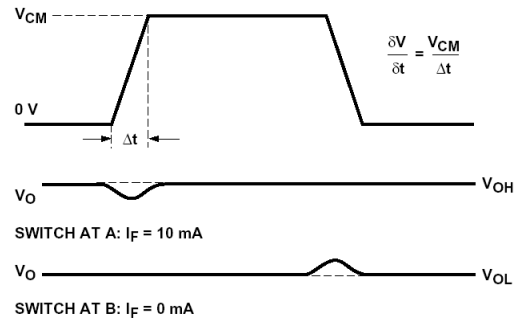
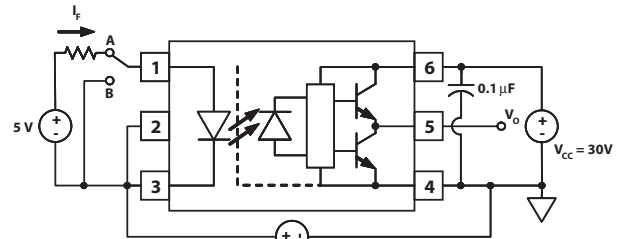

Figure 16. CMR Test Circuit and Waveforms.

Applications Information

Eliminating Negative IGBT Gate Drive

To keep the IGBT firmly off, the ACPL-P302/W302 has a very low maximum V_{OL} specification of 1.0 V. Minimizing R_g and the lead inductance from the ACPL-P302/W302 to the IGBT gate and emitter (possibly by mounting the ACPL-P302/W302 on a small PC board directly above the IGBT) can eliminate the need for negative IGBT gate drive in many applications as shown in Figure 17. Care should be taken with such a PC board design to avoid routing the IGBT collector or emitter traces close to the ACPL-P302/W302 input as this can result in unwanted coupling of transient signals into the input of ACPL-P302/W302 and degrade performance. (If the IGBT drain must be routed near the ACPL-P302/W302 input, then the LED should be reverse biased when in the off state, to prevent the transient signals coupled from the IGBT drain from turning on the ACPL-P302/W302.

Selecting the Gate Resistor (R_g)

Step 1: Calculate R_g minimum from the I_{OL} peak specification. The IGBT and R_g in Figure 17 can be analyzed as a simple RC circuit with a voltage supplied by the ACPL-P302/W302.

$$R_g \geq \frac{V_c - V_o}{I_{OLPEAK}} = \frac{2 - 1}{0.4} = 57.5 \Omega$$

The V_{OL} value of 1 V in the previous equation is the V_{OL} at the peak current of 0.4A. (See Figure 4).

Step 2: Check the ACPL-P302/W302 power dissipation and increase R_g if necessary. The ACPL-P302/W302 total power dissipation (P_T) is equal to the sum of the emitter power (P_E) and the output power (P_O).

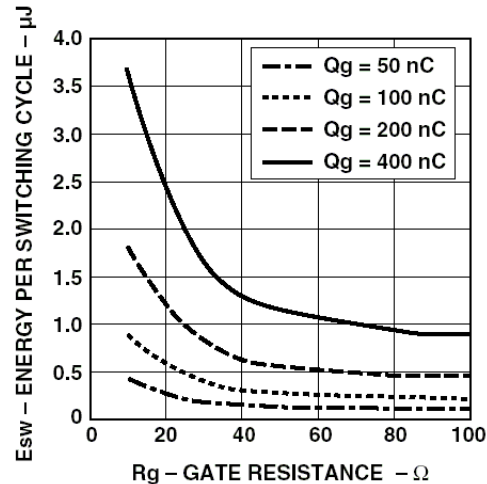

Figure 18. Energy Dissipated in the ACPL-P302/W302 and for Each IGBT Switching Cycle.

$$P_T = P_E + P_O$$

$$P_E = I_F \cdot V_F \cdot \text{DutyCycle}$$

$$P_O = P_{O(BIAS)} + P_{O(SWITCHING)} = I_c \cdot V_c + E_{sw} (R_g; Q_g) \cdot f$$

$$= (I_{CCBIAS} + K_{ICC} \cdot Q_g \cdot f) \cdot V_c + E_{sw} (R_g; Q_g) \cdot f$$

where $K_{ICC} \cdot Q_g \cdot f$ is the increase in I_{CC} due to switching and K_{ICC} is a constant of 0.001 mA/(nC*kHz). For the circuit in Figure 17 with I_F (worst case) = 10 mA, $R_g = 57.5 \Omega$, Max Duty Cycle = 80%, $Q_g = 100$ nC, $f = 20$ kHz and $T_{MAX} = 85^\circ\text{C}$:

$$P_E = 10\text{mA} \cdot 1.8\text{V} \cdot 0.8 = 14\text{mW}$$

$$P_O = (3\text{mA} + (0.001\text{mA}/\text{nC} \cdot \text{kHz}) \cdot 20\text{kHz} \cdot 100\text{nC}) \cdot 24\text{V} + 0.3\text{i} \cdot 20\text{kHz} = 126\text{mW} \leq 250\text{mW} (P_{O(MAX)} @ 85^\circ\text{C})$$

The value of 3 mA for I_{CC} in the previous equation is the max. I_{CC} over entire operating temperature range.

Since P_O for this case is less than $P_{O(MAX)}$, $R_g = 57.5 \Omega$ is alright for the power dissipation.

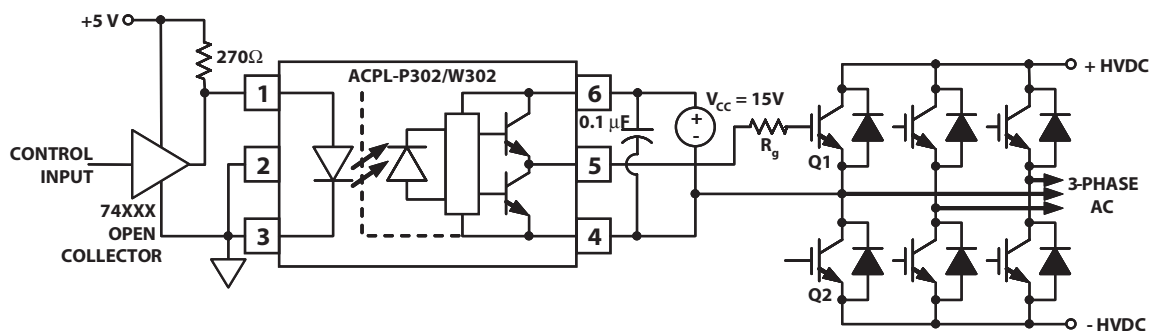

Figure 17. Recommended LED Drive and Application Circuit for ACPL-P302/W302

LED Drive Circuit Considerations for Ultra High CMR Performance

Without a detector shield, the dominant cause of optocoupler CMR failure is capacitive coupling from the input side of the optocoupler, through the package, to the detector IC as shown in Figure 19. The ACPL-P302/W302 improves CMR performance by using a detector IC with an optically transparent Faraday shield, which diverts the capacitively coupled current away from the sensitive IC circuitry. However, this shield does not eliminate the capacitive coupling between the LED and optocoupler pins 5-8 as shown in Figure 20. This capacitive coupling causes perturbations in the LED current during common mode transients and becomes the major source of CMR failures for a shielded optocoupler. The main design objective of a high CMR LED drive circuit becomes keeping the LED in the proper state (on or off) during common mode transients. For example, the recommended application circuit (Figure 17), can achieve 10 kV/ μ s CMR while minimizing component complexity.

Techniques to keep the LED in the proper state are discussed in the next two sections.

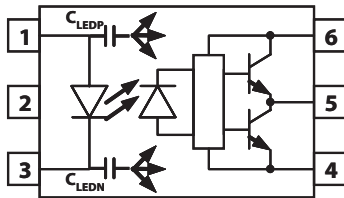

Figure 19. Optocoupler Input to Output Capacitance Model for Unshielded Optocouplers.

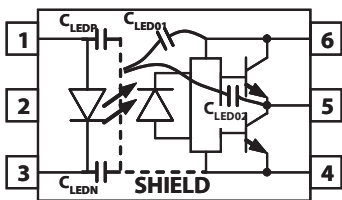

Figure 20. Optocoupler Input to Output Capacitance Model for Shielded Optocouplers.

CMR with the LED On (CMR_H)

A high CMR LED drive circuit must keep the LED on during common mode transients. This is achieved by overdriving the LED current beyond the input threshold so that it is not pulled below the threshold during a transient. A minimum LED current of 7 mA provides adequate margin over the maximum I_{FLH} of 5 mA to achieve 10 kV/ μ s CMR.

CMR with the LED Off (CMR_L)

A high CMR LED drive circuit must keep the LED off ($V_F \leq V_{F(OFF)}$) during common mode transients. For example, during a $-dV_{CM}/dt$ transient in Figure 21, the current flowing through C_{LEDP} also flows through the R_{SAT} and V_{SAT} of the logic gate. As long as the low state voltage developed across the logic gate is less than $V_{F(OFF)}$ the LED will remain off and no common mode failure will occur.

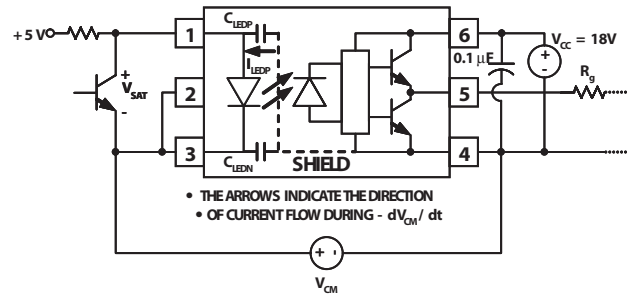

Figure 21. Equivalent Circuit for Figure 15 During Common Mode Transient.

The open collector drive circuit, shown in Figure 22, can not keep the LED off during a $+dV_{CM}/dt$ transient, since all the current flowing through C_{LEDN} must be supplied by the LED, and it is not recommended for applications requiring ultra high CMR_L performance. The alternative drive circuit which like the recommended application circuit (Figure 17), does achieve ultra high CMR performance by shunting the LED in the off state.

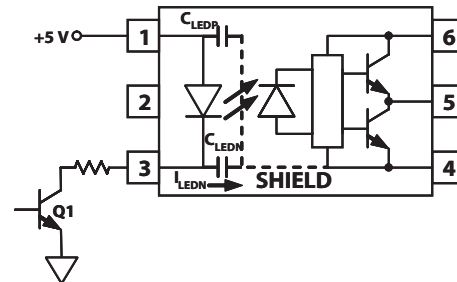

Figure 22. Not Recommended Open Collector Drive Circuit.

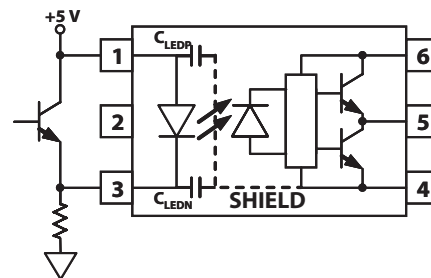
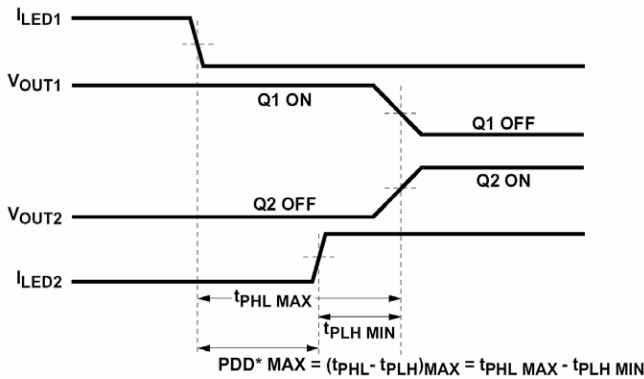

Figure 23. Recommended LED Drive Circuit for Ultra-High CMR Dead Time and Propagation Delay Specifications.

Dead Time and Propagation Delay Specifications

The ACPL-P302/W302 includes a Propagation Delay Difference (PDD) specification intended to help designers minimize “dead time” in their power inverter designs. Dead time is the time high and low side power transistors are off. Any overlap in Q1 and Q2 conduction will result in large currents flowing through the power devices from the high voltage to the low-voltage motor rails. To minimize dead time in a given design, the turn on of LED2 should be delayed (relative to the turn off of LED1) so that under worst-case conditions, transistor Q1 has just turned off when transistor Q2 turns on, as shown in Figure 24. The amount of delay necessary to achieve this condition is equal to the maximum value of the propagation delay difference specification, PDD max, which is specified to be 500 ns over the operating temperature range of -40° to 100°C.



*PDD = PROPAGATION DELAY DIFFERENCE
NOTE: FOR PDD CALCULATIONS THE PROPAGATION DELAYS ARE TAKEN AT THE SAME TEMPERATURE AND TEST CONDITIONS.

Figure 24. Minimum LED Skew for Zero Dead Time.

Delaying the LED signal by the maximum propagation delay difference ensures that the minimum dead time is zero, but it does not tell a designer what the maximum dead time will be. The maximum dead time is equivalent to the difference between the maximum and minimum propagation delay difference specification as shown in Figure 25. The maximum dead time for the ACPL-P302/W302 is 1 μ s (= 0.5 μ s - (-0.5 μ s)) over the operating temperature range of -40°C to 100°C.

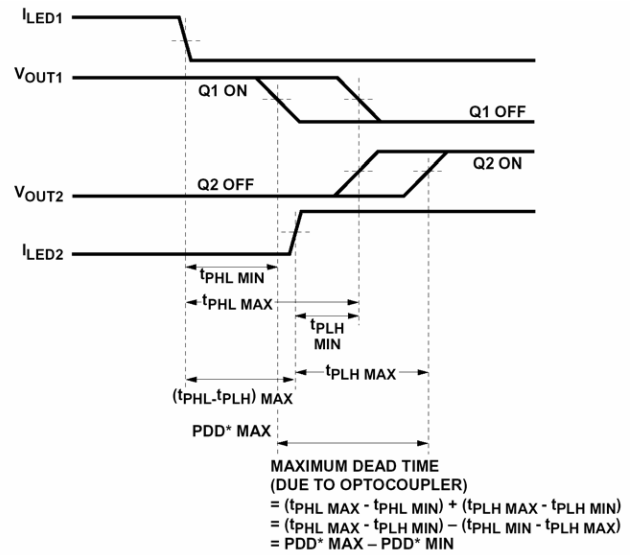

*PDD = PROPAGATION DELAY DIFFERENCE
NOTE: FOR DEAD TIME AND PDD CALCULATIONS ALL PROPAGATION DELAYS ARE TAKEN AT THE SAME TEMPERATURE AND TEST CONDITIONS.

Figure 25. Waveforms for Dead Time.

Note that the propagation delays used to calculate PDD and dead time are taken at equal temperatures and test conditions since the optocouplers under consideration are typically mounted in close proximity to each other and are switching identical IGBTs.

For product information and a complete list of distributors, please go to our web site: www.avagotech.com

Avago, Avago Technologies, and the A logo are trademarks of Avago Technologies, Limited in the United States and other countries. Data subject to change. Copyright © 2007 Avago Technologies Limited. All rights reserved. Obsoletes AV02-0091EN AV02-0157EN- April 19, 2007

