

FEATURES

- 20 MHz maximum external clock rate**
- Second-order modulator**
- 16 bits no missing codes**
- ±2 LSB INL typical at 16 bits**
- 3.5 $\mu\text{V}/^\circ\text{C}$ maximum offset drift**
- On-board digital isolator**
- On-board reference**
- Low power operation: 20 mA maximum at 5.25 V**
- −40°C to +105°C operating range**
- 16-lead SOIC package**
- Safety and regulatory approvals**
 - UL recognition
 - 3750 V rms for 1 minute per UL 1577
 - CSA Component Acceptance Notice #5A
 - VDE Certificate of Conformity
 - DIN V VDE V 0884-10 (VDE V 0884-10):2006-12
 - $V_{\text{IORM}} = 891 \text{ V peak}$

APPLICATIONS

- AC motor controls**
- Data acquisition systems**
- A/D + opto-isolator replacements**

GENERAL DESCRIPTION

The AD7401¹ is a second-order, sigma-delta (Σ - Δ) modulator that converts an analog input signal into a high speed, 1-bit data stream with on-chip digital isolation based on Analog Devices, Inc. *iCoupler*[®] technology. The AD7401 operates from a 5 V power supply and accepts a differential input signal of $\pm 200 \text{ mV}$ ($\pm 320 \text{ mV}$ full scale). The analog input is continuously sampled by the analog modulator, eliminating the need for external sample-and-hold circuitry. The input information is contained in the output stream as a density of ones with a data rate up to 20 MHz. The original information can be reconstructed with an appropriate digital filter. The serial I/O can use a 5 V or a 3 V supply (V_{DD2}).

The serial interface is digitally isolated. High speed CMOS, combined with monolithic air core transformer technology, means the on-chip isolation provides outstanding performance characteristics, superior to alternatives such as optocoupler devices. The part contains an on-chip reference. The AD7401 is offered in a 16-lead SOIC and has an operating temperature range of -40°C to $+105^\circ\text{C}$.

An internal clock version, [AD7400](#), is also available.

¹ Protected by U.S. Patents 5,952,849; 6,873,065; and 7,075,329. Other patents pending.

FUNCTIONAL BLOCK DIAGRAM

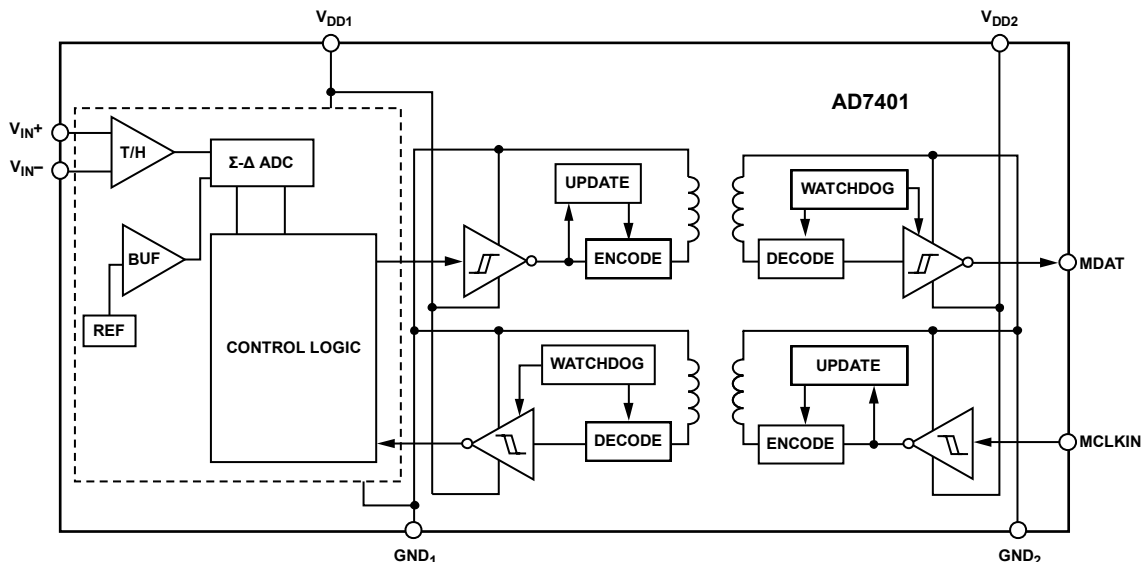

Figure 1.

06851-001

Rev. B

Information furnished by Analog Devices is believed to be accurate and reliable. However, no responsibility is assumed by Analog Devices for its use, nor for any infringements of patents or other rights of third parties that may result from its use. Specifications subject to change without notice. No license is granted by implication or otherwise under any patent or patent rights of Analog Devices. Trademarks and registered trademarks are the property of their respective owners.

TABLE OF CONTENTS

Features	1	Typical Performance Characteristics	9
Applications.....	1	Terminology	12
General Description	1	Theory of Operation	13
Functional Block Diagram	1	Circuit Information.....	13
Revision History	2	Analog Input	13
Specifications.....	3	Differential Inputs	14
Timing Specifications	4	Digital Filter	15
Insulation and Safety-Related Specifications.....	5	Applications Information	17
Regulatory Information.....	5	Grounding and Layout	17
DIN V VDE V 0884-10 (VDE V 0884-10) Insulation		Evaluating the AD7401 Performance	17
Characteristics	6	Insulation Lifetime	17
Absolute Maximum Ratings.....	7	Outline Dimensions	18
ESD Caution.....	7	Ordering Guide	18
Pin Configuration and Function Descriptions.....	8		

REVISION HISTORY

9/07—Rev. A to Rev. B

Updated VDE Certification Throughout	1
Changes to Table 6.....	7

12/06—Rev. 0 to Rev. A

Changes to Features and General Description	1
Changes to Table 1.....	3

Changes to Table 2.....	4
Changes to Table 6.....	7
Changes to Table 8.....	8
Changes to Circuit Information Section	13
Changes to Figure 27.....	15

1/06—Revision 0: Initial Version

SPECIFICATIONS

$V_{DD1} = 4.5\text{ V to }5.25\text{ V}$, $V_{DD2} = 3\text{ V to }5.5\text{ V}$, $V_{IN+} = -200\text{ mV to }+200\text{ mV}$, and $V_{IN-} = 0\text{ V}$ (single-ended); $T_A = T_{MIN}$ to T_{MAX} , $f_{MCLK} = 16\text{ MHz}$ maximum, tested with Sinc³ filter, 256 decimation rate, as defined by Verilog code, unless otherwise noted.

Table 1.

Parameter	Y Version ^{1,2}	Unit	Test Conditions/Comments
STATIC PERFORMANCE			
Resolution	16	Bits min	Filter output truncated to 16 bits
Integral Nonlinearity ³	±15	LSB max	−40°C to +85°C; ±2 LSB typical; $f_{MCLK} = 20\text{ MHz}$ maximum ⁴
	±25	LSB max	>85°C to 105°C
Differential Nonlinearity ³	±55	LSB max	$f_{MCLK} = 20\text{ MHz}$ maximum ⁴ ; $V_{IN+} = -250\text{ mV to }+250\text{ mV}$
	±0.9	LSB max	Guaranteed no missed codes to 16 bits;
Offset Error ³	±0.6	mV max	$f_{MCLK} = 20\text{ MHz}$ maximum ⁴ ; $V_{IN+} = -250\text{ mV to }+250\text{ mV}$
	±50	µV typ	$T_A = 25^\circ\text{C}$
Offset Drift vs. Temperature	3.5	µV/°C max	−40°C to +105°C
	1	µV/°C typ	
Offset Drift vs. V_{DD1}	120	µV/V typ	
Gain Error ³	±1.6	mV max	−40°C to +85°C
	±2	mV max	>85°C to 105°C
Gain Error Drift vs. Temperature	±1	mV typ	$f_{MCLK} = 20\text{ MHz}$ maximum ⁴ ; $V_{IN+} = -250\text{ mV to }+250\text{ mV}$
	23	µV/°C typ	−40°C to +105°C
Gain Error Drift vs. V_{DD1}	110	µV/V typ	
ANALOG INPUT			
Input Voltage Range	±200	mV min/mV max	For specified performance; full range ±320 mV
Dynamic Input Current	±9	µA max	$V_{IN+} = 400\text{ mV}$, $V_{IN-} = 0\text{ V}$
DC Leakage Current	±0.5	µA max	
Input Capacitance	10	pF typ	
DYNAMIC SPECIFICATIONS			
Signal-to-(Noise + Distortion) Ratio (SINAD) ³	70	dB min	$V_{IN+} = 5\text{ kHz}$, 400 mV p-p sine
	68	dB min	−40°C to +85°C; $f_{MCLK} = 9\text{ MHz to }20\text{ MHz}$ ⁴
	65	dB min	−40°C to +85°C; $f_{MCLK} = 5\text{ MHz to }<9\text{ MHz}$
	65	dB min	>85°C to 105°C
	81	dB typ	$f_{MCLK} = 20\text{ MHz}$ maximum ⁴ ; $V_{IN+} = -250\text{ mV to }+250\text{ mV}$
Signal-to-Noise Ratio (SNR)	80	dB min	−40°C to +105°C; 82 dB typ
	80	dB min	$f_{MCLK} = 20\text{ MHz}$ maximum ⁴ ; $V_{IN+} = -250\text{ mV to }+250\text{ mV}$
Total Harmonic Distortion (THD) ³	−92	dB typ	$f_{MCLK} = 20\text{ MHz}$ maximum ⁴ ; $V_{IN+} = -250\text{ mV to }+250\text{ mV}$
Peak Harmonic or Spurious Noise (SFDR) ³	−92	dB typ	
Effective Number of Bits (ENOB) ³	11.5	Bits	
Isolation Transient Immunity ³	25	kV/µs min	
	30	kV/µs typ	
LOGIC INPUTS			
Input High Voltage, V_{IH}	$0.8 \times V_{DD2}$	V min	
Input Low Voltage, V_{IL}	$0.2 \times V_{DD2}$	V max	
Input Current, I_{IN}	±0.5	µA max	
Input Capacitance, C_{IN} ⁵	10	pF max	

AD7401

Parameter	Y Version ^{1, 2}	Unit	Test Conditions/Comments
LOGIC OUTPUTS			
Output High Voltage, V_{OH}	$V_{DD2} - 0.1$	V min	$I_o = -200 \mu A$
Output Low Voltage, V_{OL}	0.4	V max	$I_o = +200 \mu A$
POWER REQUIREMENTS			
V_{DD1}	4.5/5.25	V min/V max	$V_{DD1} = 5.25 V$ $V_{DD2} = 5.5 V$ $V_{DD2} = 3.3 V$
V_{DD2}	3/5.5	V min/V max	
I_{DD1}^6	12	mA max	
I_{DD2}^7	8	mA max	
	4	mA max	

¹ Temperature range is $-40^{\circ}C$ to $+85^{\circ}C$.

² All voltages are relative to their respective ground.

³ See the Terminology section.

⁴ For $f_{MCLK} > 16$ MHz to 20 MHz, mark space ratio is 48/52 to 52/48, $V_{DD1} = V_{DD2} = 5 V \pm 5\%$, and $T_A = -40^{\circ}C$ to $+85^{\circ}C$.

⁵ Sample tested during initial release to ensure compliance.

⁶ See Figure 15.

⁷ See Figure 17.

TIMING SPECIFICATIONS

$V_{DD1} = 4.5 V$ to $5.25 V$, $V_{DD2} = 3 V$ to $5.5 V$, $T_A = T_{MAX}$ to T_{MIN} , unless otherwise noted.¹

Table 2.

Parameter	Limit at T_{MIN} , T_{MAX}	Unit	Description
$f_{MCLKIN}^{2, 3}$	20	MHz max	Master clock input frequency
	5	MHz min	Master clock input frequency
t_1^4	25	ns max	Data access time after MCLK rising edge
t_2^4	15	ns min	Data hold time after MCLK rising edge
t_3	$0.4 \times t_{MCLKIN}$	ns min	Master clock low time
t_4	$0.4 \times t_{MCLKIN}$	ns min	Master clock high time

¹ Sample tested during initial release to ensure compliance

² Mark space ratio for clock input is 40/60 to 60/40 for f_{MCLKIN} to 16 MHz and 48/52 to 52/48 for $f_{MCLKIN} > 16$ MHz to 20 MHz.

³ $V_{DD1} = V_{DD2} = 5 V \pm 5\%$ for $f_{MCLKIN} > 16$ MHz to 20 MHz.

⁴ Measured with the load circuit of Figure 2 and defined as the time required for the output to cross 0.8 V or 2.0 V.

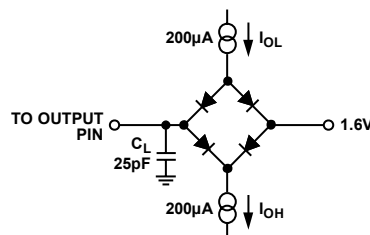

Figure 2. Load Circuit for Digital Output Timing Specifications

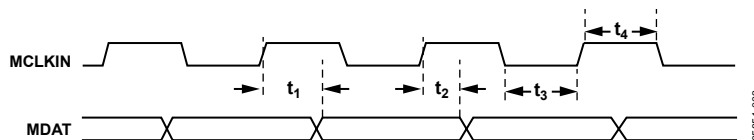

Figure 3. Data Timing

INSULATION AND SAFETY-RELATED SPECIFICATIONS

Table 3.

Parameter	Symbol	Value	Unit	Conditions
Input-to-Output Momentary Withstand Voltage	V _{ISO}	3750 min	V rms	1-minute duration
Minimum External Air Gap (Clearance)	L(I01)	7.46 min	mm	Measured from input terminals to output terminals, shortest distance through air
Minimum External Tracking (Creepage)	L(I02)	8.1 min	mm	Measured from input terminals to output terminals, shortest distance path along body
Minimum Internal Gap (Internal Clearance)		0.017 min	mm	Insulation distance through insulation
Tracking Resistance (Comparative Tracking Index)	CTI	>175	V	DIN IEC 112/VDE 0303 Part 1
Isolation Group		IIIa		Material Group (DIN VDE 0110, 1/89, Table I)

REGULATORY INFORMATION

Table 4.

UL ¹	CSA	VDE ²
Recognized under 1577 Component Recognition Program ¹	Approved under CSA Component Acceptance Notice #5A	Certified according to DIN V VDE V 0884-10 (VDE V 0884-10):2006-12 ²
3750 V rms Isolation Voltage	Reinforced insulation per CSA 60950-1-03 and IEC 60950-1, 630 V rms maximum working voltage	Reinforced insulation per DIN V VDE V 0884-10 (VDE V 0884-10):2006-12, 891V peak
File E214100	File 205078	File 2471900-4880-0001

¹ In accordance with UL 1577, each AD7401 is proof tested by applying an insulation test voltage ≥ 4500 V rms for 1 second (current leakage detection limit = 7.5 μ A).

² In accordance with DIN V VDE V 0884-10, each AD7401 is proof tested by applying an insulation test voltage ≥ 1671 V peak for 1 second (partial discharge detection limit = 5 pC).

AD7401

DIN V VDE V 0884-10 (VDE V 0884-10) INSULATION CHARACTERISTICS

This isolator is suitable for reinforced electrical isolation only within the safety limit data. Maintenance of the safety data is ensured by means of protective circuits.

Table 5.

Description	Symbol	Characteristic	Unit
INSTALLATION CLASSIFICATION PER DIN VDE 0110 For Rated Mains Voltage ≤ 300 V rms For Rated Mains Voltage ≤ 450 V rms For Rated Mains Voltage ≤ 600 V rms		I-IV I-II I-II	
CLIMATIC CLASSIFICATION		40/105/21	
POLLUTION DEGREE (DIN VDE 0110, TABLE I)		2	
MAXIMUM WORKING INSULATION VOLTAGE	V_{IORM}	891	V peak
INPUT-TO-OUTPUT TEST VOLTAGE, METHOD B1 $V_{IORM} \times 1.875 = V_{PR}$, 100% Production Test, $t_m = 1$ sec, Partial Discharge < 5 pC	V_{PR}	1671	V peak
INPUT-TO-OUTPUT TEST VOLTAGE, METHOD A After Environmental Test Subgroup 1 $V_{IORM} \times 1.6 = V_{PR}$, $t_m = 60$ sec, Partial Discharge < 5 pC After Input and/or Safety Test Subgroup 2/3 $V_{IORM} \times 1.2 = V_{PR}$, $t_m = 60$ sec, Partial Discharge < 5 pC	V_{PR}	1426 1069	V peak V peak
HIGHEST ALLOWABLE OVERVOLTAGE (TRANSIENT OVERVOLTAGE, $t_{TR} = 10$ sec)	V_{TR}	6000	V peak
SAFETY-LIMITING VALUES (MAXIMUM VALUE ALLOWED IN THE EVENT OF A FAILURE, ALSO SEE Figure 4) Case Temperature Side 1 Current Side 2 Current	T_S I_{S1} I_{S2}	150 265 335	$^{\circ}C$ mA mA
INSULATION RESISTANCE AT T_S , $V_{IO} = 500$ V	R_S	$>10^9$	Ω

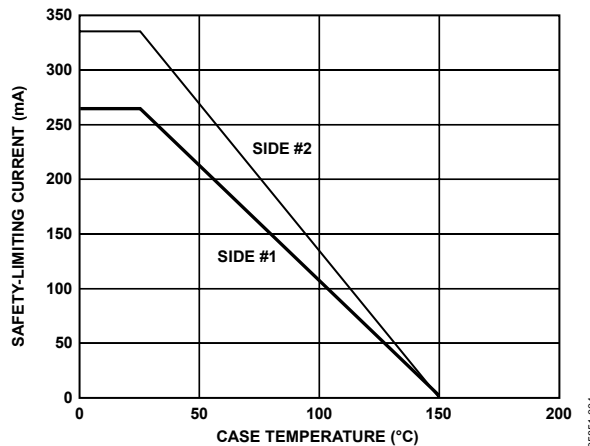

Figure 4. Thermal Derating Curve, Dependence of Safety-Limiting Values with Case Temperature per DIN V VDE V 0884-10

ABSOLUTE MAXIMUM RATINGS

$T_A = 25^\circ\text{C}$, unless otherwise noted. All voltages are relative to their respective ground.

Table 6.

Parameter	Rating
V_{DD1} to GND_1	-0.3 V to +6.5 V
V_{DD2} to GND_2	-0.3 V to +6.5 V
Analog Input Voltage to GND_1	-0.3 V to $V_{DD1} + 0.3$ V
Digital Input Voltage to GND_2	-0.3 V to $V_{DD1} + 0.5$ V
Output Voltage to GND_2	-0.3 V to $V_{DD2} + 0.3$ V
Input Current to Any Pin Except Supplies ¹	± 10 mA
Operating Temperature Range	-40°C to $+105^\circ\text{C}$
Storage Temperature Range	-65°C to $+150^\circ\text{C}$
Junction Temperature	150°C
SOIC Package	
θ_{JA} Thermal Impedance	$89.2^\circ\text{C}/\text{W}$
θ_{JC} Thermal Impedance	$55.6^\circ\text{C}/\text{W}$
Resistance (Input to Output), R_{I-O}	$10^{12} \Omega$
Capacitance (Input to Output), C_{I-O} ²	1.7 pF typ
Pb-Free Temperature, Soldering	
Reflow	$260 (+0)^\circ\text{C}$
ESD	1.5 kV

¹ Transient currents of up to 100 mA do not cause SCR to latch-up.

² $f = 1$ MHz.

Stresses above those listed under Absolute Maximum Ratings may cause permanent damage to the device. This is a stress rating only; functional operation of the device at these or any other conditions above those indicated in the operational section of this specification is not implied. Exposure to absolute maximum rating conditions for extended periods may affect device reliability.

Table 7. Maximum Continuous Working Voltage¹

Parameter	Max	Unit	Constraint
AC Voltage, Bipolar Waveform	565	V_{PK}	50-year minimum lifetime
AC Voltage, Unipolar Waveform	891	V_{PK}	Maximum CSA/VDE approved working voltage
DC Voltage	891	V	Maximum CSA/VDE approved working voltage

¹ Refers to continuous voltage magnitude imposed across the isolation barrier. See the Insulation Lifetime section for more details.

ESD CAUTION



ESD (electrostatic discharge) sensitive device. Charged devices and circuit boards can discharge without detection. Although this product features patented or proprietary protection circuitry, damage may occur on devices subjected to high energy ESD. Therefore, proper ESD precautions should be taken to avoid performance degradation or loss of functionality.

AD7401

PIN CONFIGURATION AND FUNCTION DESCRIPTIONS

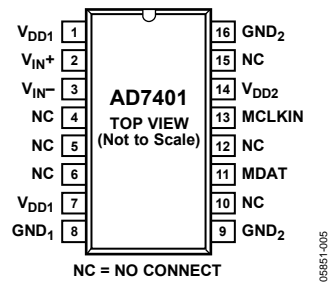

Figure 5. Pin Configuration

Table 8. Pin Function Descriptions

Pin No.	Mnemonic	Description
1, 7	V _{DD1}	Supply Voltage. 4.5 V to 5.25 V. This is the supply voltage for the isolated side of the AD7401 and is relative to GND ₁ .
2	V _{IN+}	Positive Analog Input. Specified range of ± 200 mV.
3	V _{IN-}	Negative Analog Input. Normally connected to GND ₁ .
4 to 6, 10, 12, 15	NC	No Connect.
8	GND ₁	Ground 1. This is the ground reference point for all circuitry on the isolated side.
9, 16	GND ₂	Ground 2. This is the ground reference point for all circuitry on the nonisolated side.
11	MDAT	Serial Data Output. The single bit modulator output is supplied to this pin as a serial data stream. The bits are clocked out on the rising edge of the MCLKIN input and valid on the following MCLKIN rising edge.
13	MCLKIN	Master Clock Logic Input. 20 MHz maximum. The bit stream from the modulator is valid on the rising edge of MCLKIN.
14	V _{DD2}	Supply Voltage. 3 V to 5.5 V. This is the supply voltage for the nonisolated side and is relative to GND ₂ .

TYPICAL PERFORMANCE CHARACTERISTICS

T_A = 25°C, using a 25 kHz brick wall filter, unless otherwise noted.

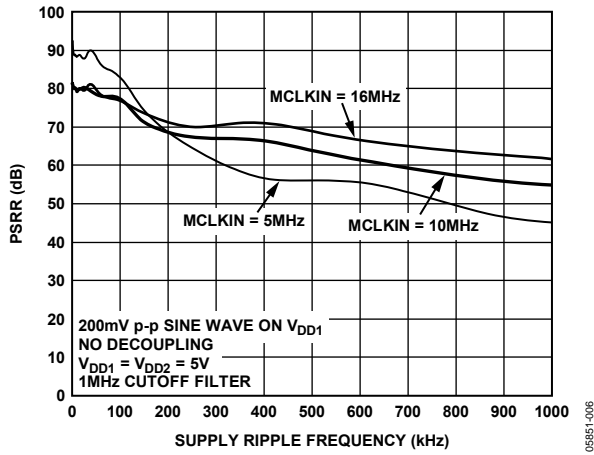

Figure 6. PSRR vs. Supply Ripple Frequency Without Supply Decoupling

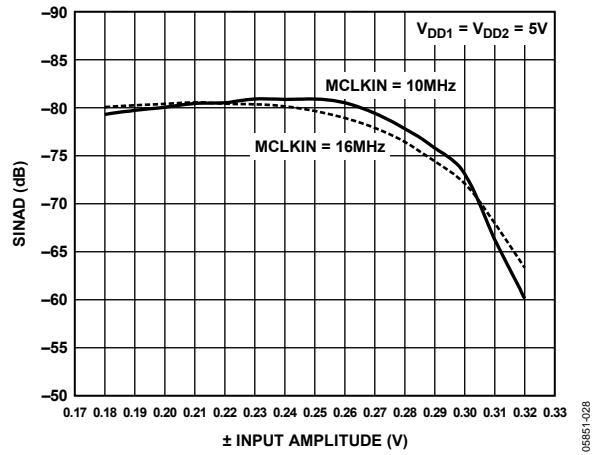

Figure 9. SINAD vs. V_{IN}

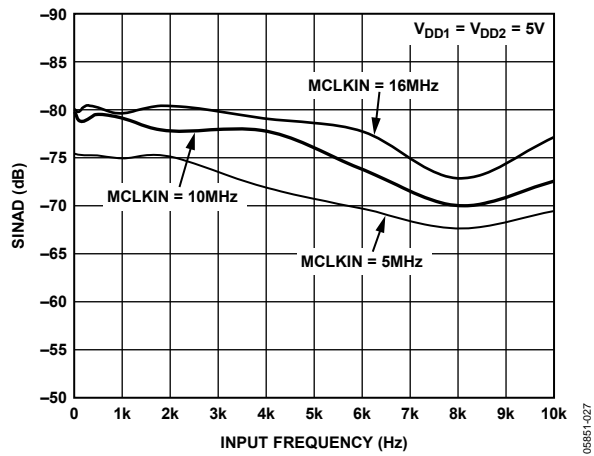

Figure 7. SINAD vs. Analog Input Frequency

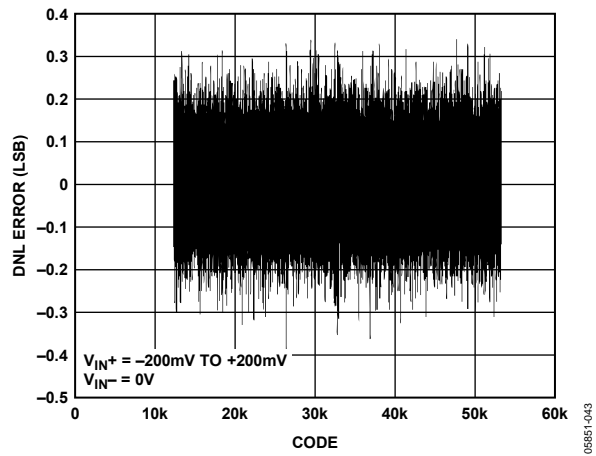

Figure 10. Typical DNL (±200 mV Range)

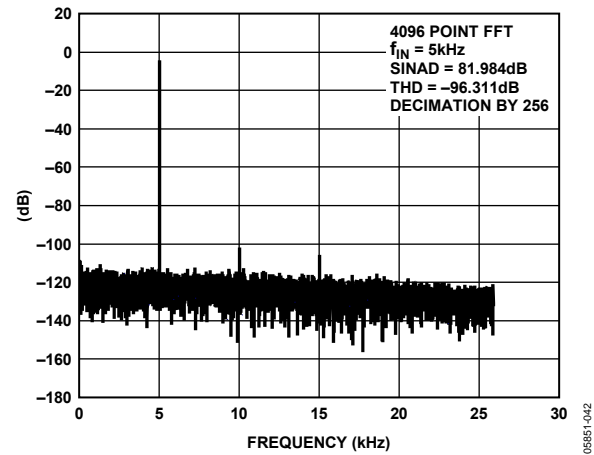

Figure 8. Typical FFT (±200 mV Range)

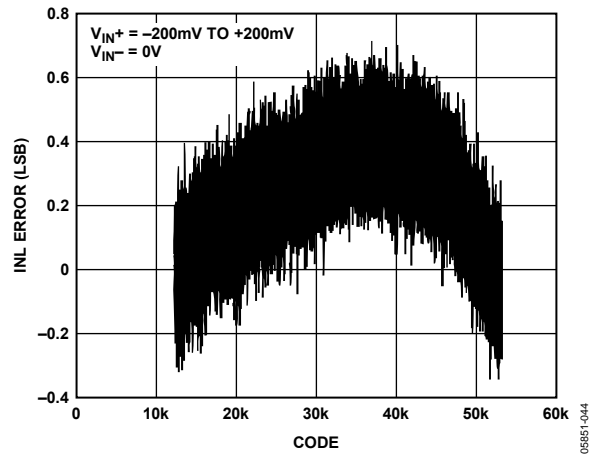

Figure 11. Typical INL (±200 mV Range)

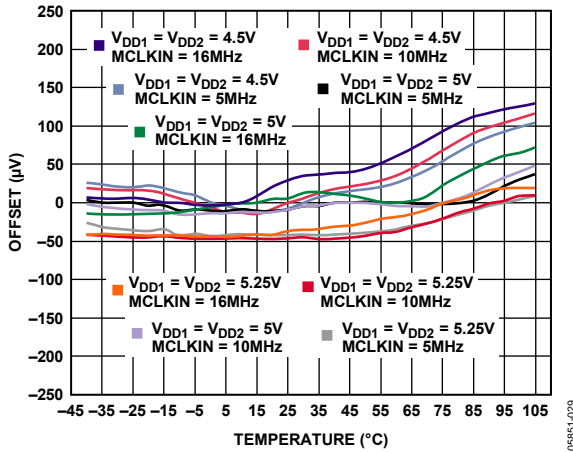

Figure 12. Offset Drift vs. Temperature for Various Supply Voltages

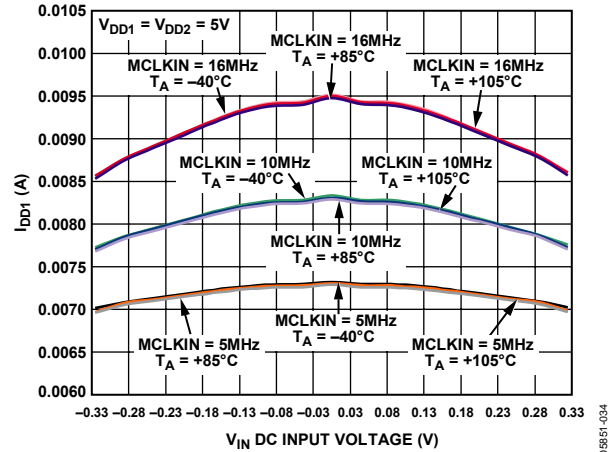

Figure 15. I_{DD1} vs. V_{IN} at Various Temperatures

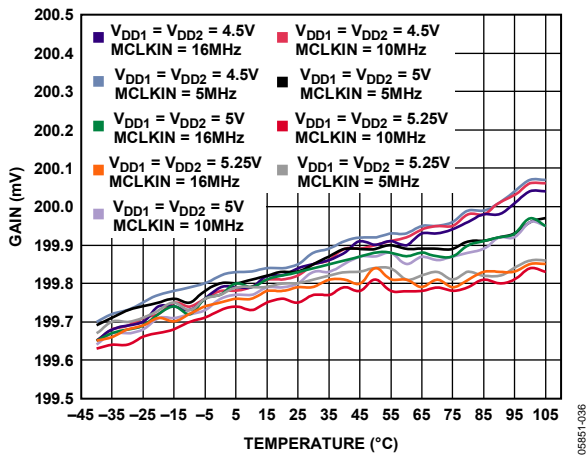

Figure 13. Gain Error Drift vs. Temperature for Various Supply Voltages

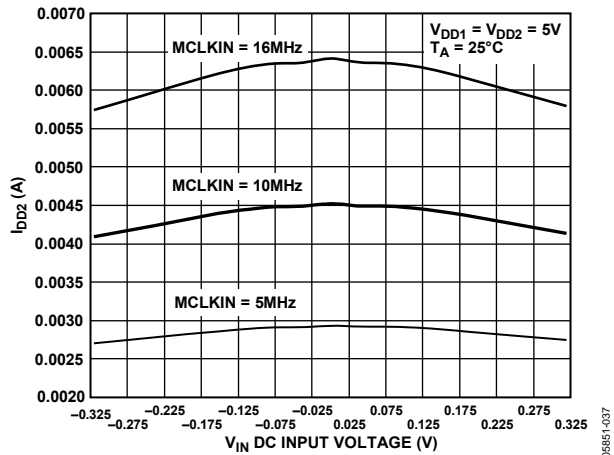

Figure 16. I_{DD2} vs. V_{IN} DC Input Voltage

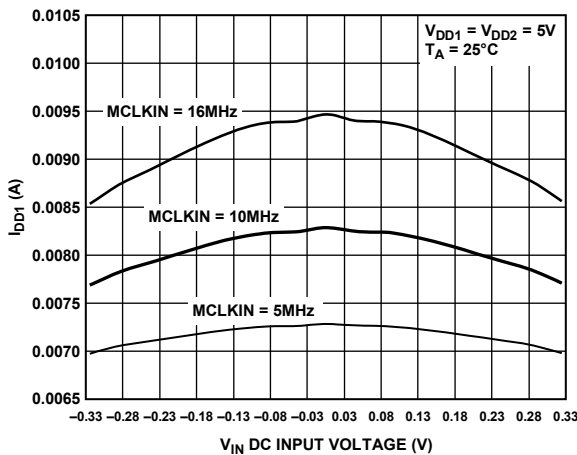

Figure 14. I_{DD1} vs. V_{IN} DC Input Voltage

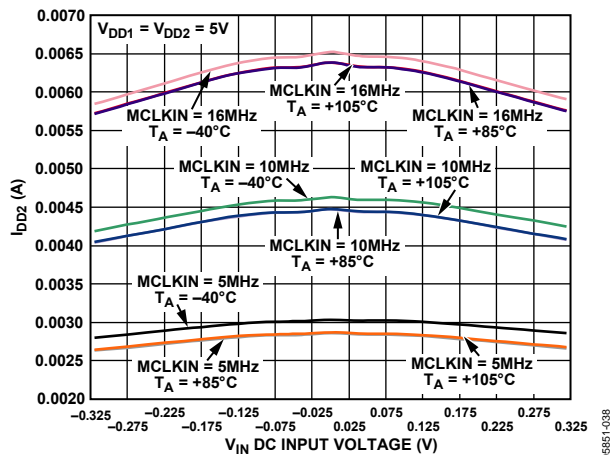

Figure 17. I_{DD2} vs. V_{IN} at Various Temperatures

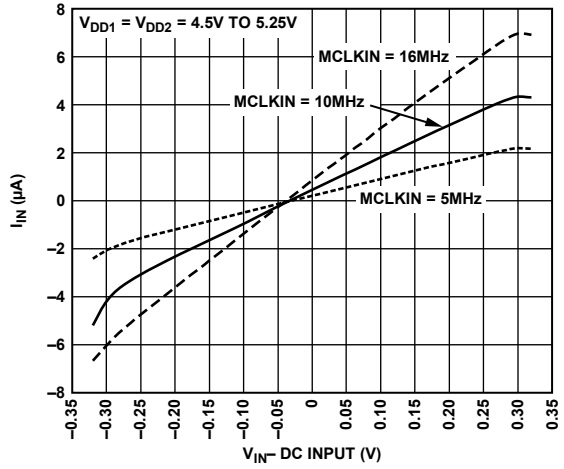

Figure 18. I_{IN} vs. V_{IN} —DC Input

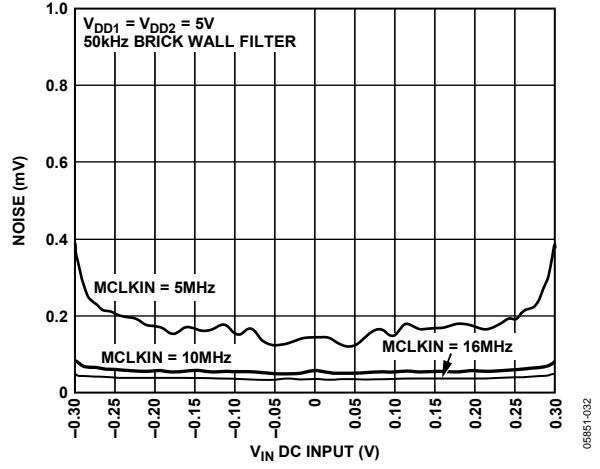

Figure 20. RMS Noise Voltage vs. V_{IN} DC Input

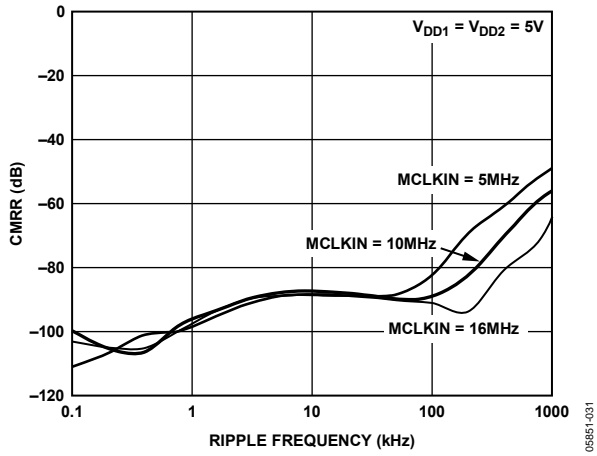

Figure 19. CMRR vs. Common-Mode Ripple Frequency

TERMINOLOGY

Differential Nonlinearity

Differential nonlinearity is the difference between the measured and the ideal 1 LSB change between any two adjacent codes in the ADC.

Integral Nonlinearity

Integral nonlinearity is the maximum deviation from a straight line passing through the endpoints of the ADC transfer function. The endpoints of the transfer function are specified negative full-scale, -200 mV ($V_{\text{IN}+} - V_{\text{IN}-}$), Code 12,288 for the 16-bit level, and specified positive full-scale, $+200\text{ mV}$ ($V_{\text{IN}+} - V_{\text{IN}-}$), Code 53,248 for the 16-bit level.

Offset Error

Offset error is the deviation of the midscale code (Code 32,768 for the 16-bit level) from the ideal $V_{\text{IN}+} - V_{\text{IN}-}$ (that is, 0 V).

Gain Error

Gain error includes both positive full-scale gain error and negative full-scale gain error. Positive full-scale gain error is the deviation of the specified positive full-scale code (53,248 for the 16-bit level) from the ideal $V_{\text{IN}+} - V_{\text{IN}-}$ ($+200\text{ mV}$) after the offset error is adjusted out. Negative full-scale gain error is the deviation of the specified negative full-scale code (12,288 for the 16-bit level) from the ideal $V_{\text{IN}+} - V_{\text{IN}-}$ (-200 mV) after the offset error is adjusted out. Gain error includes reference error.

Signal-to-(Noise + Distortion) Ratio

This ratio is the measured ratio of signal-to-(noise + distortion) at the output of the ADC. The signal is the rms amplitude of the fundamental. Noise is the sum of all nonfundamental signals up to half the sampling frequency ($f_s/2$), excluding dc. The ratio is dependent on the number of quantization levels in the digitization process; the more levels, the smaller the quantization noise. The theoretical signal-to-(noise + distortion) ratio for an ideal N-bit converter with a sine wave input is given by

$$\text{Signal-to-(Noise + Distortion)} = (6.02N + 1.76)\text{ dB}$$

Therefore, for a 12-bit converter, this is 74 dB.

Effective Number of Bits (ENOB)

The ENOB is defined by

$$\text{ENOB} = (\text{SINAD} - 1.76)/6.02$$

Total Harmonic Distortion (THD)

THD is the ratio of the rms sum of harmonics to the fundamental. For the AD7401, it is defined as

$$\text{THD(dB)} = 20\log \frac{\sqrt{V_2^2 + V_3^2 + V_4^2 + V_5^2 + V_6^2}}{V_1}$$

where:

V_1 is the rms amplitude of the fundamental.

$V_2, V_3, V_4, V_5,$ and V_6 are the rms amplitudes of the second through the sixth harmonics.

Peak Harmonic or Spurious Noise

Peak harmonic or spurious noise is defined as the ratio of the rms value of the next largest component in the ADC output spectrum (up to $f_s/2$, excluding dc) to the rms value of the fundamental. Normally, the value of this specification is determined by the largest harmonic in the spectrum, but for ADCs where the harmonics are buried in the noise floor, it is a noise peak.

Common-Mode Rejection Ratio (CMRR)

CMRR is defined as the ratio of the power in the ADC output at $\pm 200\text{ mV}$ frequency, f , to the power of a 200 mV p-p sine wave applied to the common-mode voltage of $V_{\text{IN}+}$ and $V_{\text{IN}-}$ of frequency f_s , expressed as

$$\text{CMRR (dB)} = 10\log(P_f/P_{f_s})$$

where:

P_f is the power at frequency f in the ADC output.

P_{f_s} is the power at frequency f_s in the ADC output.

Power Supply Rejection Ratio (PSRR)

Variations in power supply affect the full-scale transition but not converter linearity. PSRR is the maximum change in the specified full-scale ($\pm 200\text{ mV}$) transition point due to a change in power supply voltage from the nominal value (see Figure 6).

Isolation Transient Immunity

The isolation transient immunity specifies the rate of rise/fall of a transient pulse applied across the isolation boundary beyond which clock or data is corrupted. (It was tested using a transient pulse frequency of 100 kHz .)

THEORY OF OPERATION

CIRCUIT INFORMATION

The AD7401 isolated Σ - Δ modulator converts an analog input signal into a high speed (20 MHz maximum), single-bit data stream; the time average of the modulator's single-bit data is directly proportional to the input signal. Figure 23 shows a typical application circuit where the AD7401 is used to provide isolation between the analog input, a current sensing resistor, and the digital output, which is then processed by a digital filter to provide an N-bit word.

ANALOG INPUT

The differential analog input of the AD7401 is implemented with a switched capacitor circuit. This circuit implements a second-order modulator stage that digitizes the input signal into a 1-bit output stream. The sample clock (MCLKIN) provides the clock signal for the conversion process as well as the output data-framing clock. This clock source is external on the AD7401. The analog input signal is continuously sampled by the modulator and compared to an internal voltage reference. A digital stream that accurately represents the analog input over time appears at the output of the converter (see Figure 21).

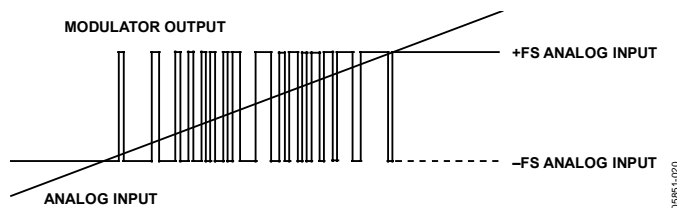

Figure 21. Analog Input vs. Modulator Output

A differential signal of 0 V results (ideally) in a stream of 1s and 0s at the MDAT output pin. This output is high 50% of the time and low 50% of the time. A differential input of 200 mV produces a stream of 1s and 0s that are high 81.25% of the time. A differential input of -200 mV produces a stream of 1s and 0s that are high 18.75% of the time.

A differential input of 320 mV results in a stream of, ideally, all 1s. This is the absolute full-scale range of the AD7401, while 200 mV is the specified full-scale range, as shown in Table 9.

Table 9. Analog Input Range

Analog Input	Voltage Input
Full-Scale Range	+640 mV
Positive Full-Scale	+320 mV
Positive Specified Input Range	+200 mV
Zero	0 mV
Negative Specified Input Range	-200 mV
Negative Full-Scale	-320 mV

To reconstruct the original information, this output needs to be digitally filtered and decimated. A Sinc³ filter is recommended because this is one order higher than that of the AD7401 modulator. If a 256 decimation rate is used, the resulting 16-bit word rate is 62.5 kHz, assuming a 16 MHz external clock frequency. Figure 22 shows the transfer function of the AD7401 relative to the 16-bit output.

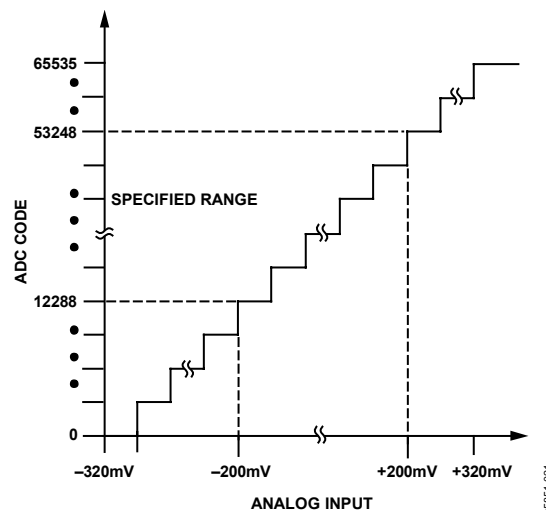

Figure 22. Filtered and Decimated 16-Bit Transfer Characteristic

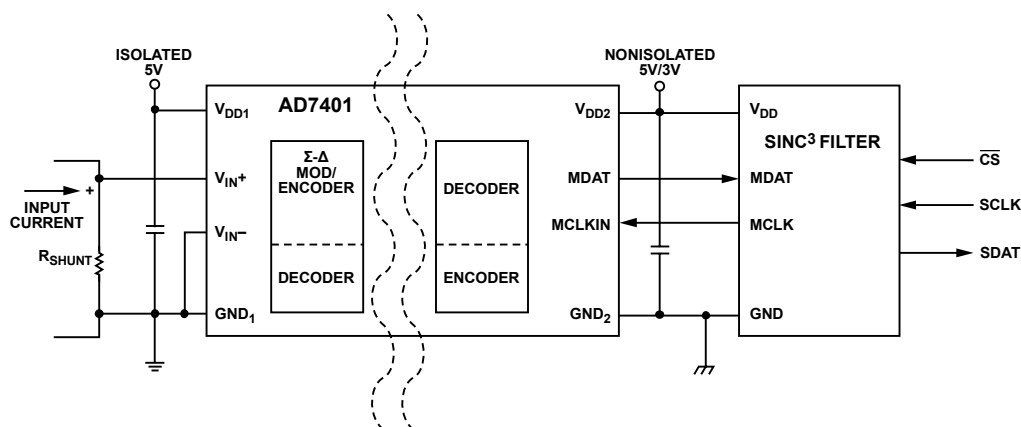

Figure 23. Typical Application Circuit

AD7401

DIFFERENTIAL INPUTS

The analog input to the modulator is a switched capacitor design. The analog signal is converted into charge by highly linear sampling capacitors. A simplified equivalent circuit diagram of the analog input is shown in Figure 24. A signal source driving the analog input must be able to provide the charge onto the sampling capacitors every half MCLKIN cycle and settle to the required accuracy within the next half cycle.

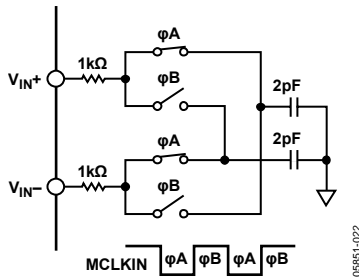

Figure 24. Analog Input Equivalent Circuit

Because the AD7401 samples the differential voltage across its analog inputs, low noise performance is attained with an input circuit that provides low common-mode noise at each input. The amplifiers used to drive the analog inputs play a critical role in attaining the high performance available from the AD7401.

When a capacitive load is switched onto the output of an op amp, the amplitude momentarily drops. The op amp tries to correct the situation and, in the process, hits its slew rate limit. This nonlinear response, which can cause excessive ringing, can lead to distortion. To remedy the situation, a low-pass RC filter can be connected between the amplifier and the input to the AD7401. The external capacitor at each input aids in supplying the current spikes created during the sampling process, and the resistor isolates the op amp from the transient nature of the load.

The recommended circuit configuration for driving the differential inputs to achieve best performance is shown in Figure 25. A capacitor between the two input pins sources or sinks charge to allow most of the charge that is needed by one input to be effectively supplied by the other input. The series resistor again isolates any op amp from the current spikes created during the sampling process. Recommended values for the resistors and capacitor are 22 Ω and 47 pF, respectively.

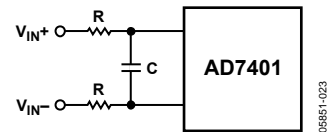

Figure 25. Differential Input RC Network

DIGITAL FILTER

A Sinc³ filter is recommended for use with the AD7401. This filter can be implemented on an FPGA or possibly a DSP. The following Verilog code provides an example of a Sinc³ filter implementation on a Xilinx[®] Spartan-II 2.5 V FPGA. This code can possibly be compiled for another FPGA, such as an Altera[®] device. Note that the data is read on the negative clock edge in this case, although it can be read on the positive edge if preferred. Figure 29 shows the effect of using different decimation rates with various filter types.

```

/*`Data is read on negative clk edge*/
module DEC256SINC24B(mdata1, mclk1, reset,
DATA);
input  mclk1;      /*used to clk filter*/
input  reset;     /*used to reset filter*/
input  mdata1;   /*ip data to be
filtered*/
output [15:0] DATA;      /*filtered op*/
integer location;
integer info_file;
reg [23:0]      ip_data1;
reg [23:0]      acc1;
reg [23:0]      acc2;
reg [23:0]      acc3;
reg [23:0]      acc3_d1;
reg [23:0]      acc3_d2;
reg [23:0]      diff1;
reg [23:0]      diff2;
reg [23:0]      diff3;
reg [23:0]      diff1_d;
reg [23:0]      diff2_d;
reg [15:0]      DATA;
reg [7:0]       word_count;
reg word_clk;
reg init;

/*Perform the Sinc ACTION*/
always @ (mdata1)
if(mdata1==0)
    ip_data1 <= 0;      /* change from a 0
to a -1 for 2's comp */
else
    ip_data1 <= 1;

/*ACCUMULATOR (INTEGRATOR)
Perform the accumulation (IIR) at the speed
of the modulator.

```

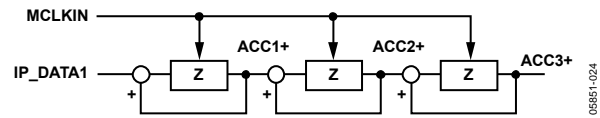

Figure 26. Accumulator

```

Z = one sample delay
MCLKIN = modulators conversion bit rate
*/
always @ (posedge mclk1 or posedge reset)
if (reset)
    begin
        /*initialize acc registers on reset*/
        acc1 <= 0;
        acc2 <= 0;
        acc3 <= 0;
    end
else
    begin
        /*perform accumulation process*/
        acc1 <= acc1 + ip_data1;
        acc2 <= acc2 + acc1;
        acc3 <= acc3 + acc2;
    end

/*DECIMATION STAGE (MCLKIN/ WORD_CLK)
*/
always @ (negedge mclk1 or posedge reset)
if (reset)
    word_count <= 0;
else
    word_count <= word_count + 1;

always @ (word_count)
    word_clk <= word_count[7];

/*DIFFERENTIATOR (including decimation stage)
Perform the differentiation stage (FIR) at a
lower speed.

```

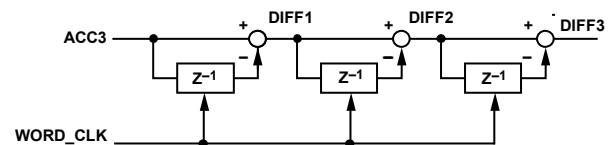

Figure 27. Differentiator

```

Z = one sample delay
WORD_CLK = output word rate
*/

```

AD7401

```

always @ (posedge word_clk or posedge reset)
if(reset)
begin
acc3_d2 <= 0;
diff1_d <= 0;
diff2_d <= 0;
diff1 <= 0;
diff2 <= 0;

diff3 <= 0;
end

```

```

else
begin
diff1 <= acc3 - acc3_d2;
diff2 <= diff1 - diff1_d;
diff3 <= diff2 - diff2_d;
acc3_d2 <= acc3;
diff1_d <= diff1;
diff2_d <= diff2;
end

```

/* Clock the Sinc output into an output register

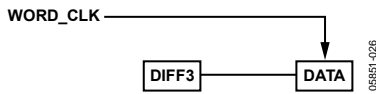

Figure 28. Clocking Sinc Output into an Output Register

WORD_CLK = output word rate
*/

```

always @ (posedge word_clk)
begin
DATA[15] <= diff3[23];
DATA[14] <= diff3[22];
DATA[13] <= diff3[21];
DATA[12] <= diff3[20];
DATA[11] <= diff3[19];
DATA[10] <= diff3[18];

```

```

DATA[9] <= diff3[17];
DATA[8] <= diff3[16];
DATA[7] <= diff3[15];
DATA[6] <= diff3[14];
DATA[5] <= diff3[13];
DATA[4] <= diff3[12];
DATA[3] <= diff3[11];
DATA[2] <= diff3[10];
DATA[1] <= diff3[9];
DATA[0] <= diff3[8];

end
endmodule

```

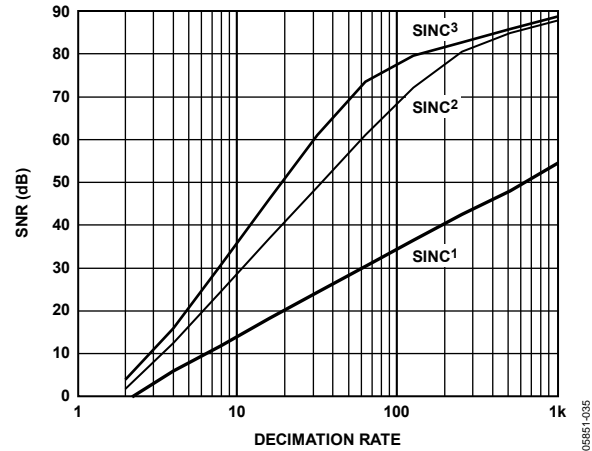

Figure 29. SNR vs. Decimation Rate for Different Filter Types

Figure 29 shows a plot of SNR performance vs. decimation rate with different filter types. Note that, for a given bandwidth requirement, a higher MCLKIN frequency can allow higher decimation rates to be used, resulting in higher SNR performance.

APPLICATIONS INFORMATION

GROUNDING AND LAYOUT

Supply decoupling with a value of 100 nF is strongly recommended on both V_{DD1} and V_{DD2} . Decoupling on one or both V_{DD1} pins does not affect performance significantly. In applications involving high common-mode transients, care should be taken to ensure that board coupling across the isolation barrier is minimized. Furthermore, the board layout should be designed so that any coupling that occurs equally affects all pins on a given component side. Failure to ensure this may cause voltage differentials between pins to exceed the absolute maximum ratings of the device, thereby leading to latch-up or permanent damage. Any decoupling used should be placed as close to the supply pins as possible.

Series resistance in the analog inputs should be minimized to avoid any distortion effects, especially at high temperatures. If possible, equalize the source impedance on each analog input to minimize offset. Beware of mismatch and thermocouple effects on the analog input PCB tracks to reduce offset drift.

EVALUATING THE AD7401 PERFORMANCE

A simple standalone AD7401 evaluation board is available with split ground planes and a board split beneath the AD7401 package to ensure isolation. This board allows access to each pin on the device for evaluation purposes. External supplies and all other circuitry (such as a digital filter) must be provided by the user.

INSULATION LIFETIME

All insulation structures, subjected to sufficient time and/or voltage, are vulnerable to breakdown. In addition to the testing performed by the regulatory agencies, Analog Devices has carried out an extensive set of evaluations to determine the lifetime of the insulation structure within the AD7401.

These tests subjected populations of devices to continuous cross-isolation voltages. To accelerate the occurrence of failures, the selected test voltages were values exceeding those of normal use. The time-to-failure values of these units were recorded and used to calculate acceleration factors. These factors were then used to calculate the time to failure under normal operating conditions. The values shown in Table 7 are the lesser of the following two values:

- The value that ensures at least a 50-year lifetime of continuous use
- The maximum CSA/VDE approved working voltage

It should also be noted that the lifetime of the AD7401 varies according to the waveform type imposed across the isolation barrier. The *iCoupler* insulation structure is stressed differently depending on whether the waveform is bipolar ac, unipolar ac, or dc. Figure 30, Figure 31, and Figure 32 illustrate the different isolation voltage waveforms.

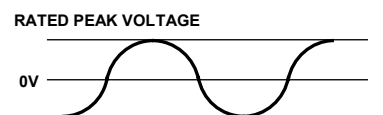

Figure 30. Bipolar AC Waveform

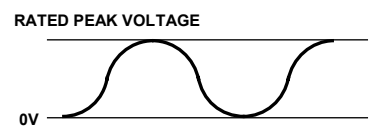

Figure 31. Unipolar AC Waveform

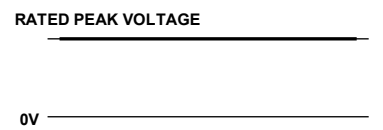
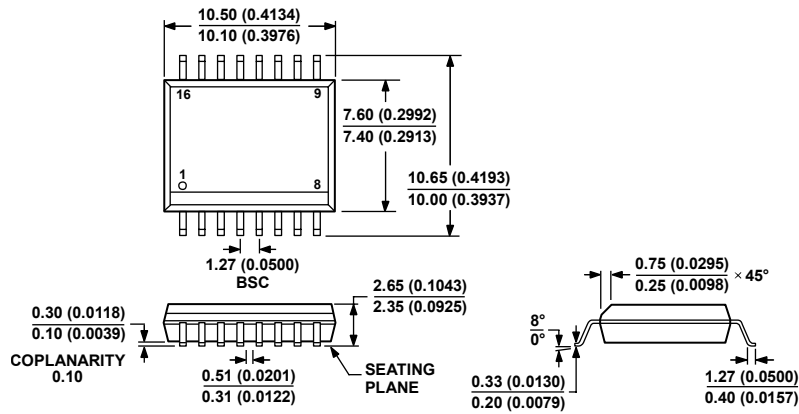

Figure 32. DC Waveform

OUTLINE DIMENSIONS



COMPLIANT TO JEDEC STANDARDS MS-013-AA
 CONTROLLING DIMENSIONS ARE IN MILLIMETERS; INCH DIMENSIONS
 (IN PARENTHESES) ARE ROUNDED-OFF MILLIMETER EQUIVALENTS FOR
 REFERENCE ONLY AND ARE NOT APPROPRIATE FOR USE IN DESIGN.

Figure 33. 16-Lead Standard Small Outline Package [SOIC_W]
 Wide Body
 (RW-16)

Dimensions shown in millimeters and (inches)

032707-B

ORDERING GUIDE

Model	Temperature Range	Package Description	Package Option
AD7401YRW	-40°C to +105°C	16-Lead Standard Small Outline Package [SOIC_W]	RW-16
AD7401YRW-REEL	-40°C to +105°C	16-Lead Standard Small Outline Package [SOIC_W]	RW-16
AD7401YRW-REEL7	-40°C to +105°C	16-Lead Standard Small Outline Package [SOIC_W]	RW-16
AD7401YRWZ ¹	-40°C to +105°C	16-Lead Standard Small Outline Package [SOIC_W]	RW-16
AD7401YRWZ-REEL ¹	-40°C to +105°C	16-Lead Standard Small Outline Package [SOIC_W]	RW-16
AD7401YRWZ-REEL7 ¹	-40°C to +105°C	16-Lead Standard Small Outline Package [SOIC_W]	RW-16
EVAL-AD7401EBZ ¹		Standalone Evaluation Board	

¹ Z = RoHS Compliant Part.

NOTES

AD7401

NOTES