

**Features**

- High surge current capability
- Designed for a wide range of applications
- Stud cathode and stud anode version
- Leaded version available
- Types up to 1600V  $V_{RRM}$

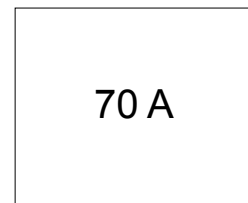

**Typical Applications**

- Battery charges
- Converters
- Power supplies
- Machine tool controls

**Major Ratings and Characteristics**

| Parameters       | 70HF(R)     |              | Units            |
|------------------|-------------|--------------|------------------|
|                  | 10 to 120   | 140 to 160   |                  |
| $I_{F(AV)}$      | 70          | 70           | A                |
| @ $T_C$          | 140         | 110          | °C               |
| $I_{F(RMS)}$     | 110         |              | A                |
| $I_{FSM}$ @ 50Hz | 1200        |              | A                |
| @ 60Hz           | 1250        |              | A                |
| $I^2t$ @ 50Hz    | 7100        |              | A <sup>2</sup> s |
| @ 60Hz           | 6450        |              | A <sup>2</sup> s |
| $V_{RRM}$ range  | 100 to 1200 | 1400 to 1600 | V                |
| $T_J$ range      | - 65 to 180 | - 65 to 150  | °C               |



## 70HF(R) Series

Bulletin I20202 rev. E 03/04

International  
IR Rectifier

### ELECTRICAL SPECIFICATIONS

#### Voltage Ratings

| Type number | Voltage Code | $V_{RRM}$ , maximum repetitive peak reverse voltage<br>V | $V_{RSM}$ , maximum non-repetitive peak reverse voltage<br>V | $V_{R(BR)}$ , minimum avalanche voltage<br>V | $I_{RRM}$ max.<br>@ $T_J = T_J$ max.<br>mA |
|-------------|--------------|--|--|--|--|
| 70HF(R)     | 10           | 100  | 200  | 200  | 15   |
|             | 20           | 200  | 300  | 300  |  |
|             | 40           | 400  | 500  | 500  |  |
|             | 60           | 600  | 720  | 725  | 9  |
|             | 80           | 800  | 960  | 950  |  |
|             | 100          | 1000   | 1200   | 1150   |  |
|             | 120          | 1200   | 1440   | 1350   |  |
|             | 140          | 1400   | 1650   | 1550   | 4.5  |
| 160         | 1600         | 1900   | 1750   |  |  |

#### Forward Conduction

| Parameter  | 70HF(R)   |            | Units             | Conditions  |                           |
|--|-----------|------------|-------------------|---|---------------------------|
|  | 10 to 120 | 140 to 160 |                   |   |                           |
| $I_{F(AV)}$ Max. average forward current @ Case temperature          | 70        | 70         | A                 | 180° conduction, half sine wave   |                           |
|  | 140       | 110        | °C                |   |                           |
| $I_{F(RMS)}$ Max. RMS forward current                                | 110       |            | A                 |   |                           |
| $I_{FSM}$ Max. peak, one-cycle forward, non-repetitive surge current | 1200      |            | A                 | t = 10ms  | No voltage reappplied     |
|  | 1250      |            |                   | t = 8.3ms   |                           |
|  | 1000      |            |                   | t = 10ms  | 100% $V_{RRM}$ reappplied |
|  | 1050      |            |                   | t = 8.3ms   |                           |
| $I^2t$ Maximum $I^2t$ for fusing                                     | 7100      |            | A <sup>2</sup> s  | t = 10ms  | No voltage reappplied     |
|  | 6450      |            |                   | t = 8.3ms   |                           |
|  | 5000      |            |                   | t = 10ms  | 100% $V_{RRM}$ reappplied |
|  | 4550      |            |                   | t = 8.3ms   |                           |
| $I^2/t$ Maximum $I^2/t$ for fusing                                   | 71000     |            | A <sup>2</sup> /s | t = 0.1 to 10ms, no voltage reappplied  |                           |
| $V_{F(TO)1}$ Low level value of threshold voltage                    | 0.79      |            | V                 | (16.7% $\times \pi \times I_{F(AV)} < I < \pi \times I_{F(AV)}$ ), $T_J = T_J$ max. |                           |
| $V_{F(TO)2}$ High level value of threshold voltage                   | 1.00      |            |                   | (I $> \pi \times I_{F(AV)}$ ), $T_J = T_J$ max.                                     |                           |
| $r_{f1}$ Low level value of forward slope resistance                 | 2.33      |            | mΩ                | (16.7% $\times \pi \times I_{F(AV)} < I < \pi \times I_{F(AV)}$ ), $T_J = T_J$ max. |                           |
| $r_{f2}$ High level value of forward slope resistance                | 1.53      |            |                   | (I $> \pi \times I_{F(AV)}$ ), $T_J = T_J$ max.                                     |                           |
| $V_{FM}$ Max. forward voltage drop                                   | 1.35      | 1.46       | V                 | $I_{pk} = 220A$ , $T_J = 25^\circ C$ , $t_p = 400\mu s$ rectangular wave            |                           |

Thermal and Mechanical Specifications

| Parameter   | 70HF(R)        |            | Units    | Conditions                                 |
|---|----------------|------------|----------|--|
|   | 10 to 120      | 140 to 160 |          |  |
| T <sub>J</sub> Max. junction operating temperature range    | -65 to 180     | -65 to 150 | °C       |  |
| T <sub>stg</sub> Max. storage temperature range             | -65 to 180     | -65 to 150 |          |  |
| R <sub>thJC</sub> Max. thermal resistance, junction to case | 0.45           |            | K/W      | DC operation                               |
| R <sub>thCS</sub> Max. thermal resistance, case to heatsink | 0.25           |            |          | Mounting surface, smooth, flat and greased |
| T Max. allowed mounting torque ±10%                         | 2.3 - 3.4      |            | Nm       | Not lubricated threads                     |
|   | 20 - 30        |            | lbf · in |  |
| wt Approximate weight                                       | 17 (0.6)       |            | g (oz)   |  |
| Case style  | DO-203AB (DO5) |            |          | See Outline Table                          |

$\Delta R_{thJC}$  Conduction

(The following table shows the increment of thermal resistance R<sub>thJC</sub> when devices operate at different conduction angles than DC)

| Conduction angle | Sinusoidal conduction | Rectangular conduction | Units | Conditions                           |
|------------------|-----------------------|------------------------|-------|--------------------------------------|
| 180°             | 0.08                  | 0.06                   | K/W   | T <sub>J</sub> = T <sub>J</sub> max. |
| 120°             | 0.10                  | 0.11                   |       |                                      |
| 90°              | 0.13                  | 0.14                   |       |                                      |
| 60°              | 0.19                  | 0.20                   |       |                                      |
| 30°              | 0.30                  | 0.30                   |       |                                      |

Ordering Information Table

**Device Code**

|           |           |          |            |          |
|-----------|-----------|----------|------------|----------|
| <b>70</b> | <b>HF</b> | <b>R</b> | <b>160</b> | <b>M</b> |
| 1         | 2         | 3        | 4          | 5        |

- 1** - 70 = Standard device  
71 = Not isolated lead  
72 = Isolated lead with silicone sleeve  
(Red = Reverse polarity)  
(Blue = Normal polarity)
- 2** - HF = Standard diode
- 3** - None = Stud Normal Polarity (Cathode to Stud)  
R = Stud Reverse Polarity (Anode to Stud)
- 4** - Voltage code: Code x 10 = V<sub>RRM</sub> (See Voltage Ratings table)
- 5** - None = Stud base DO-203AB (DO-5) 1/4" 28UNF-2A  
M = Stud base DO-203AB (DO-5) M6 X 1

**70HF(R) Series**

Bulletin I20202 rev. E 03/04

Outlines Table

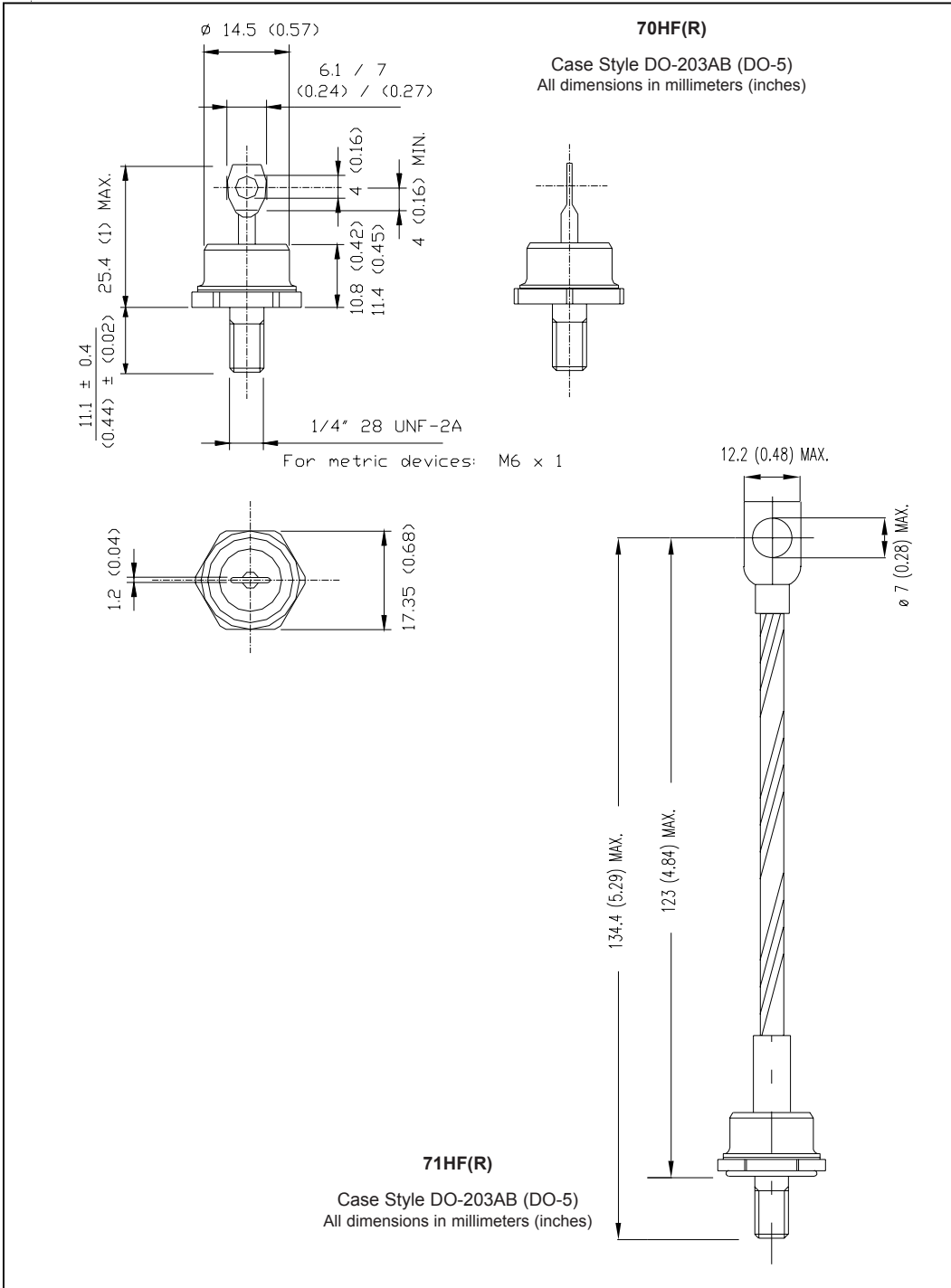



Fig. 1 - Current Ratings Characteristics



Fig. 2 - Current Ratings Characteristics

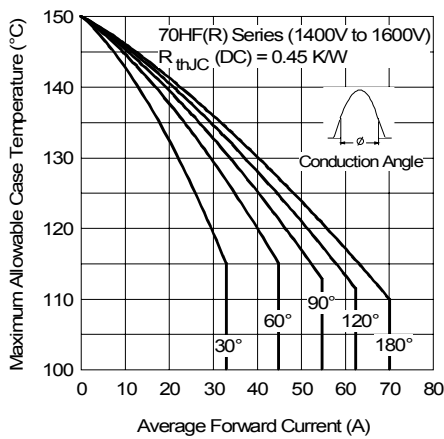

Fig. 3 - Current Ratings Characteristics

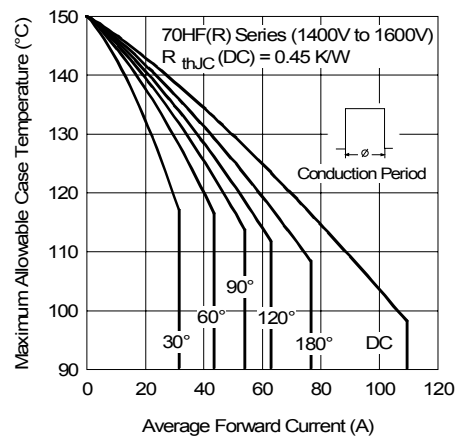

Fig. 4 - Current Ratings Characteristics



Fig. 5 - Forward Power Loss Characteristics

# 70HF(R) Series

Bulletin I20202 rev. E 03/04

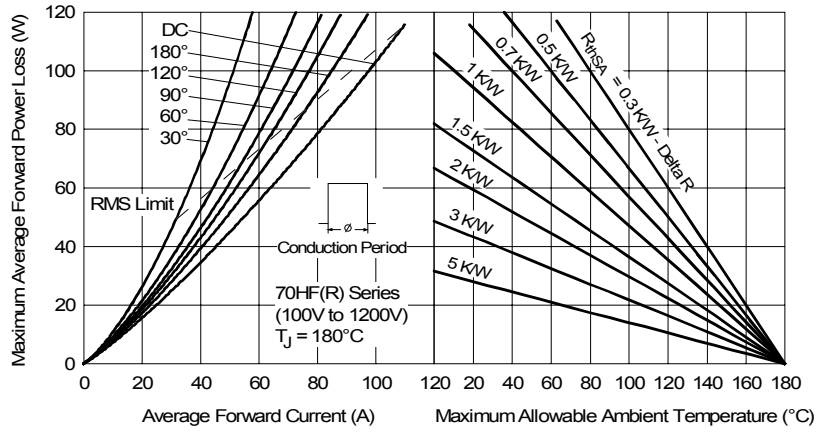

Fig. 6 - Forward Power Loss Characteristics

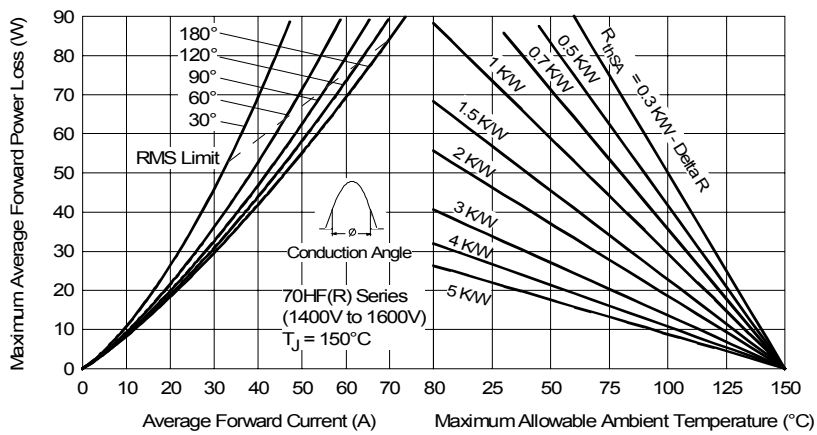

Fig. 7 - Forward Power Loss Characteristics

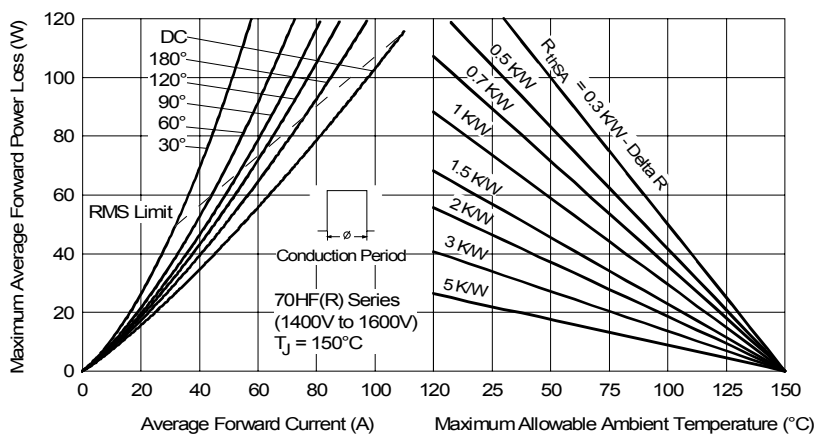

Fig. 8 - Forward Power Loss Characteristics

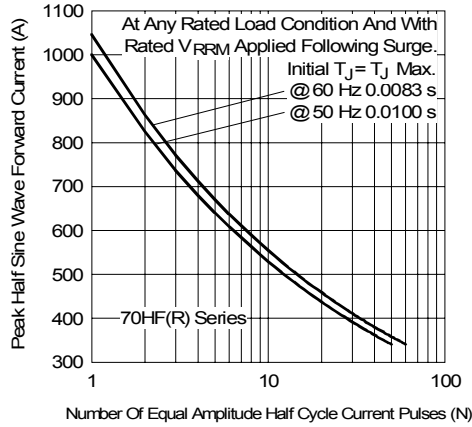

Fig. 9 - Maximum Non-Repetitive Surge Current



Fig. 10 - Maximum Non-Repetitive Surge Current

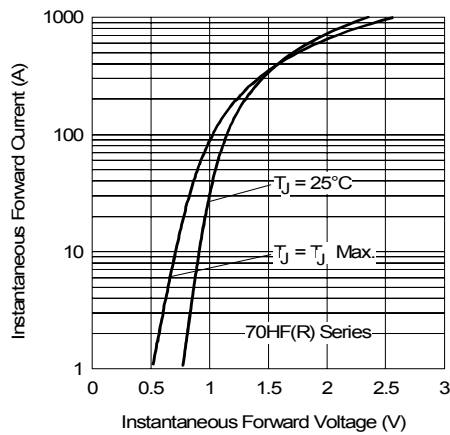

Fig. 11 - Forward Voltage Drop Characteristics

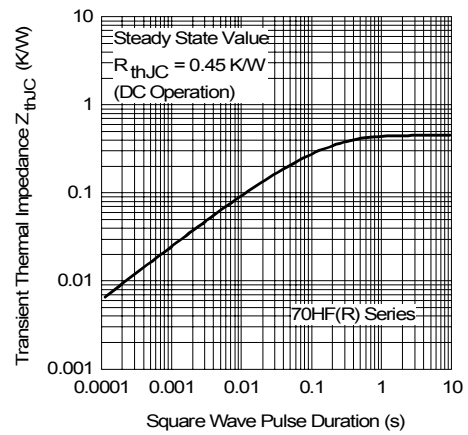

Fig. 12 - Thermal Impedance  $Z_{thJc}$  Characteristics



Fig. 13 - Forward Voltage Drop Characteristics

## 70HF(R) Series

Bulletin I20202 rev. E 03/04

International  
**IOR** Rectifier

---

Data and specifications subject to change without notice.  
This product has been designed and qualified for Industrial Level.  
Qualification Standards can be found on IR's Web site.

International  
**IOR** Rectifier

**IR WORLD HEADQUARTERS:** 233 Kansas St., El Segundo, California 90245, USA Tel: (310) 252-7105  
TAC Fax: (310) 252-7309  
Visit us at [www.irf.com](http://www.irf.com) for sales contact information. 03/04