

International
IR Rectifier

QUIETIR Series
 8EWF12S

**SURFACE MOUNTABLE FAST
 SOFT RECOVERY DIODE**
 Lead-Free ("PbF" suffix)

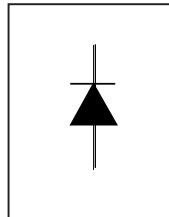

$$V_F < 1.3V @ 8A$$

$$t_{rr} = 80ns$$

$$V_{RRM} = 1200V$$

Description/ Features

The 8EWF12SPbF fast soft recovery *QUIETIR* rectifier series has been optimized for combined short reverse recovery time, low forward voltage drop and low leakage current

The glass passivation ensures stable reliable operation in the most severe temperature and power cycling conditions.

Typical applications are both:

- Output rectification and freewheeling diode in inverters, choppers and converters.
- Input rectifications where severe restrictions on conducted EMI should be met.

Major Ratings and Characteristics

Characteristics	Values	Units
$I_{F(AV)}$ Sinusoidal waveform	8	A
V_{RRM}	1200	V
I_{FSM}	170	A
V_F @8A, $T_J=25^\circ C$	1.3	V
t_{rr} @1A, 100A/ μs	80	ns
T_J range	-40 to 150	$^\circ C$

Package Outline



Voltage Ratings

Part Number	V_{RRM} , maximum peak reverse voltage V	V_{RSM} , maximum non repetitive peak reverse voltage V	I_{RRM} 150°C mA
8EWF12SPbF	1200	1300	4

Absolute Maximum Ratings

Parameters	8EWF	Units	Conditions
$I_{F(AV)}$ Max. Average Forward Current	8	A	@ $T_C = 94^\circ\text{C}$, 180° conduction half sine wave
I_{FSM} Max. Peak One Cycle Non-Repetitive Surge Current	170	A	10ms Sine pulse, rated V_{RRM} applied
	200		10ms Sine pulse, no voltage reapplied
I^2t Max. I^2t for fusing	144	A^2s	10ms Sine pulse, rated V_{RRM} applied
	200		10ms Sine pulse, no voltage reapplied
$I^2\sqrt{t}$ Max. $I^2\sqrt{t}$ for fusing	2000	$A^2\sqrt{s}$	t = 0.1 to 10ms, no voltage reapplied

Electrical Specifications

Parameters	8EWF	Units	Conditions
V_{FM} Max. Forward Voltage Drop	1.3	V	@ 8A, $T_J = 25^\circ\text{C}$
r_t Forward slope resistance	25.6	$m\Omega$	$T_J = 150^\circ\text{C}$
$V_{F(TO)}$ Threshold voltage	0.93	V	
I_{RM} Max. Reverse Leakage Current	0.1	mA	$T_J = 25^\circ\text{C}$
	4		$T_J = 150^\circ\text{C}$

$V_R = \text{rated } V_{RRM}$

Typical Reverse Recovery Characteristics

Parameters	8EWF	Units	Conditions
t_{rr} Reverse Recovery Time	270	ns	$I_F @ 8\text{Apk}$ @ 25A/ μs @ $T_J = 25^\circ\text{C}$
I_{rr} Reverse Recovery Current	4.2	A	
Q_{rr} Reverse Recovery Charge	1	μC	
S Typical Snap Factor	tb/ta	-	

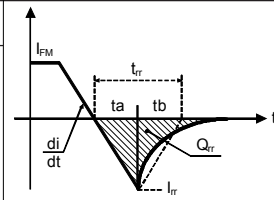

Thermal-Mechanical Specifications

Parameters	8EWF	Units	Conditions
T_J Max. Junction Temperature Range	-40 to 150	°C	
T_{stg} Max. Storage Temperature Range	-40 to 150	°C	
	Soldering Temperature	240	°C for 10 seconds
R_{thJC} Max. Thermal Resistance Junction to Case	2.5	°C/W	DC operation
R_{thJA} Typ. Thermal Resistance Junction to Ambient (PCB Mount)**	50	°C/W	
wt Approximate Weight	1(0.03)	g(oz.)	
T Case Style	TO-252AA (D-Pak)		
Marking Device	8EWF12S		

** When mounted on 1" square (650mm²) PCB of FR-4 or G-10 material 4 oz (140µm) copper 40°C/W
For recommended footprint and soldering techniques refer to application note #AN-994

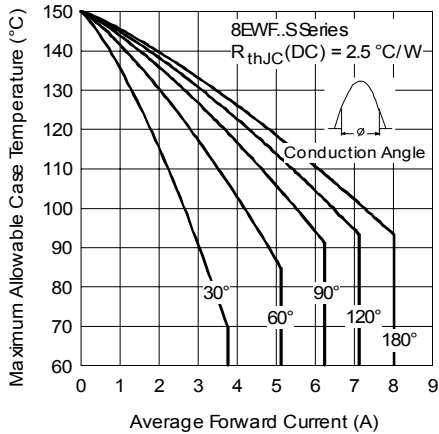

Fig. 1 - Current Rating Characteristics

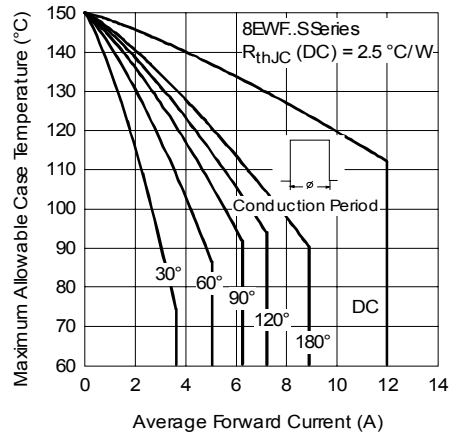

Fig. 2 - Current Rating Characteristics

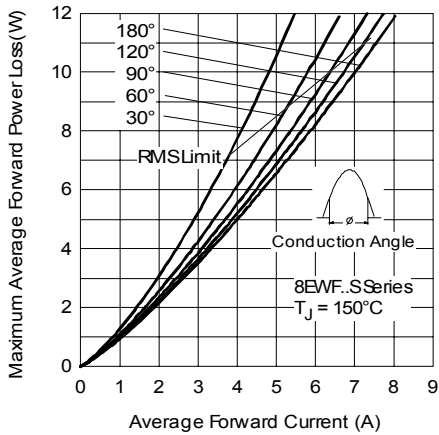

Fig. 3 - Forward Power Loss Characteristics

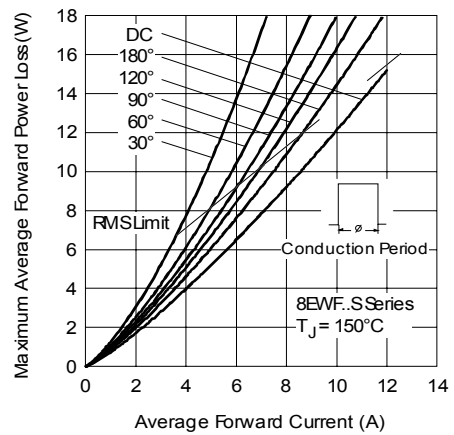

Fig. 4 - Forward Power Loss Characteristics

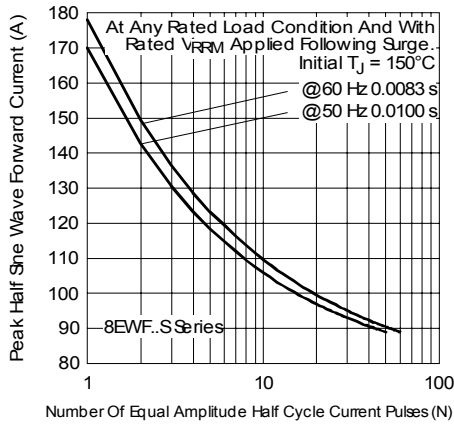

Fig. 5 - Maximum Non-Repetitive Surge Current

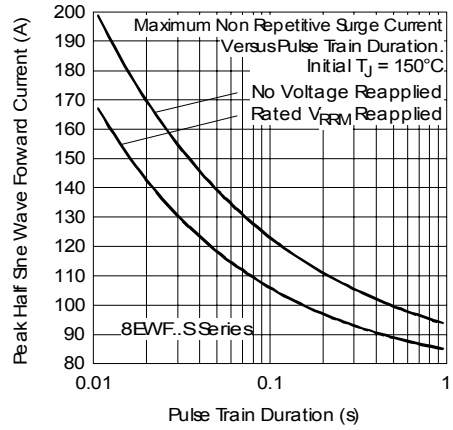

Fig. 6 - Maximum Non-Repetitive Surge Current

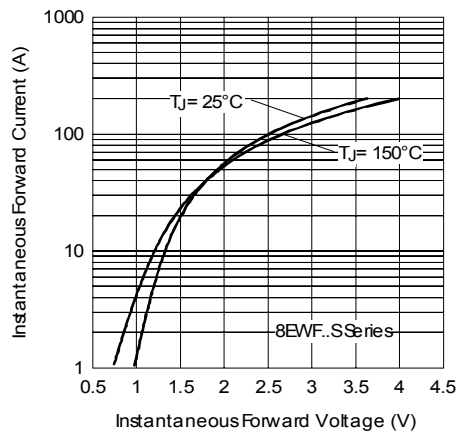

Fig. 7 - Forward Voltage Drop Characteristics

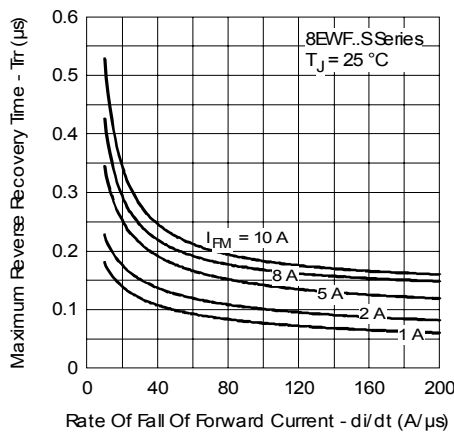

Fig. 8 - Recovery Time Characteristics, $T_J = 25^\circ\text{C}$

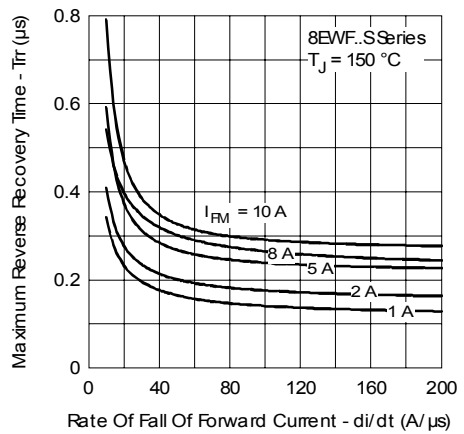

Fig. 9 - Recovery Time Characteristics, $T_J = 150^\circ\text{C}$

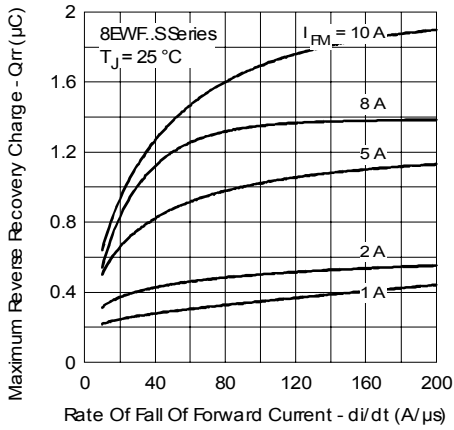

Fig. 10 - Recovery Charge Characteristics, T_J = 25°C

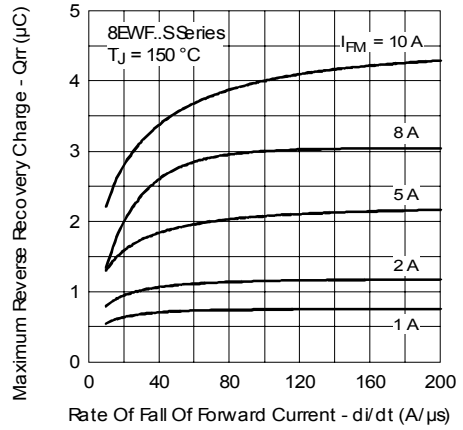

Fig. 11 - Recovery Charge Characteristics, T_J = 150°C

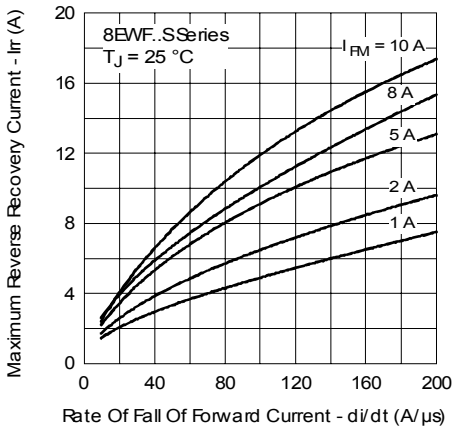

Fig. 12 - Recovery Current Characteristics, T_J = 25°C

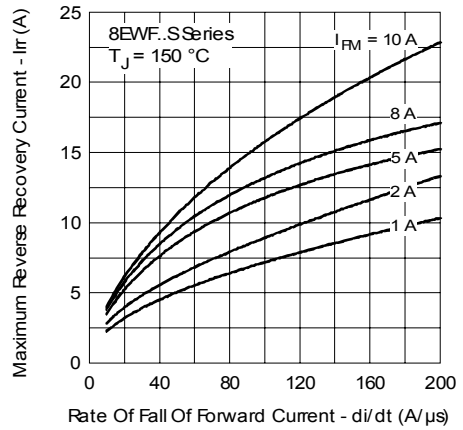

Fig. 13 - Recovery Current Characteristics, T_J = 150°C

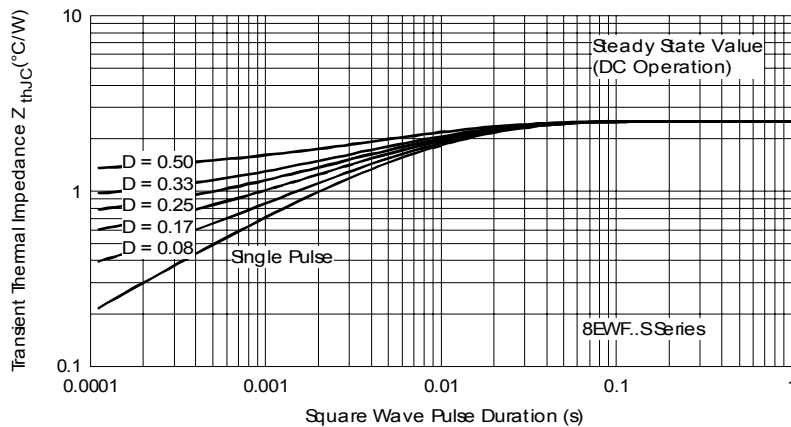
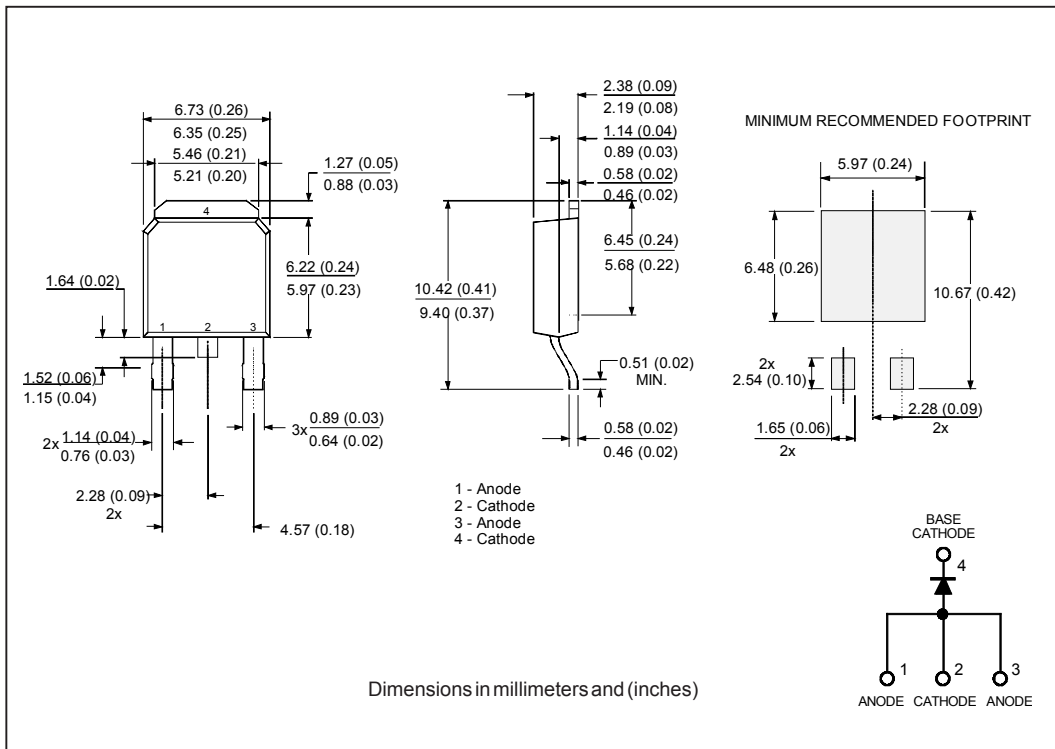
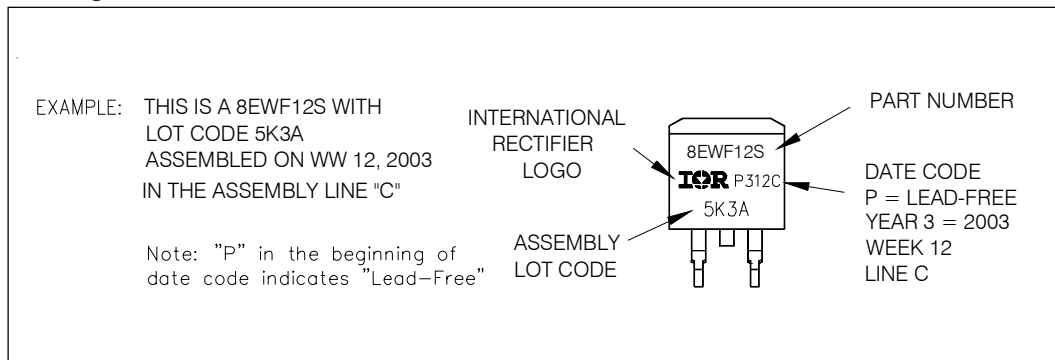

Fig. 14 - Thermal Impedance Z_{thJC} Characteristics

Outline Table



Marking Information



Tape & Reel Information

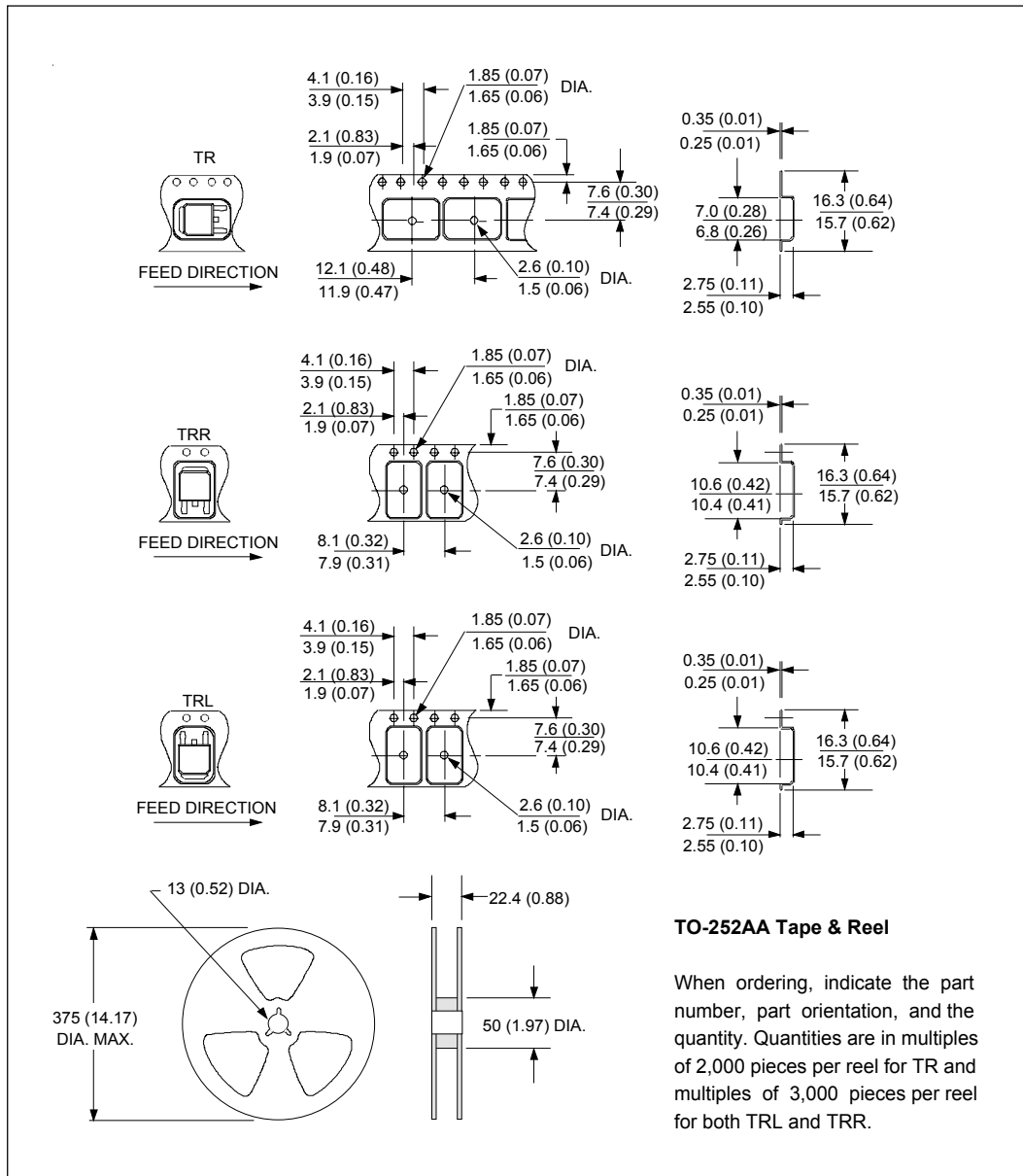

TO-252AA Tape & Reel

When ordering, indicate the part number, part orientation, and the quantity. Quantities are in multiples of 2,000 pieces per reel for TR and multiples of 3,000 pieces per reel for both TRL and TRR.

Ordering Information Table

Device Code	
8	E
W	F
12	S
TR	PbF
(1)	(2)
(3)	(4)
(5)	(6)
(7)	(8)
1	- Current Rating (8 = 8A)
2	- Circuit Configuration: E = Single Diode
3	- Package: W = D-Pak
4	- Type of Silicon: F = Fast Soft Recovery Rectifier
5	- Voltage Rating (12 = 1200V)
6	- S = Surface Mountable
7	- • TR = Tape & Reel • TRR = Tape & Reel (Right Oriented) • TRL = Tape & Reel (Left Oriented)
8	- • none = Standard Production • PbF = Lead-Free

Data and specifications subject to change without notice.
This product has been designed and qualified for Industrial Level and Lead-Free.
Qualification Standards can be found on IR's Web site.

International
IOR Rectifier

IR WORLD HEADQUARTERS: 233 Kansas St., El Segundo, California 90245, USA Tel: (310) 252-7105
TAC Fax: (310) 252-7309
Visit us at www.irf.com for sales contact information. 03/05