

EFM[®]32

... the world's most energy friendly microcontrollers

TINY GECKO DATASHEET

EFM32TG840F32/EFM32TG840F16/EFM32TG840F8

Preliminary

0 1 2 3 4

- **ARM Cortex-M3 CPU platform**
 - High Performance 32-bit processor @ up to 32 MHz
 - Wake-up Interrupt Controller
- **Flexible Energy Management System**
 - 20 nA @ 3 V Shutoff Mode
 - 0.6 μ A @ 3 V Stop Mode, including Power-on Reset, Brown-out Detector, RAM and CPU retention
 - 0.9 μ A @ 3 V Deep Sleep Mode, including Real Time Clock with 32.768 kHz oscillator, Power-on Reset, Brown-out Detector, RAM and CPU retention
 - 45 μ A/MHz @ 3 V Sleep Mode
 - 180 μ A/MHz @ 3 V Run Mode, with code executed from flash
- **32/16/8 KB Flash**
- **4/4/2 KB RAM**
- **56 General Purpose I/O pins**
 - Configurable Push-pull, Open-drain, pull-up/down, input filter, drive strength
 - Configurable peripheral I/O locations
 - 16 asynchronous external interrupts
- **8 Channel DMA Controller**
- **8 Channel Peripheral Reflex System for autonomous inter-peripheral signaling**
- **Hardware AES with 128/256-bit keys in 54/75 cycles**
- **Timers/Counters**
 - 2x 16-bit Timer/Counter
 - 2x3 Compare/Capture/PWM channels
 - Dead-Time Insertion on TIMER0
 - 16-bit Low Energy Timer
 - 24-bit Real-Time Counter
 - 8-bit Pulse Counter
 - Asynchronous pulse counting/quadrature decoding
 - Watchdog Timer with dedicated RC oscillator @ 50 nA
- **Integrated LCD Controller for up to 4x24 segments**
 - Voltage boost, adjustable contrast adjustment and autonomous animation feature
- **Communication interfaces**
 - Universal Synchronous/Asynchronous Receiver/Transmitter
 - UART/SPI/SmartCard (ISO 7816)/IrDA
 - Triple buffered full/half-duplex operation
 - 4-16 data bits
 - Universal Asynchronous Receiver/Transmitter
 - Triple buffered full/half-duplex operation
 - 8-9 data bits
 - Low Energy UART
 - Autonomous operation with DMA in Deep Sleep Mode
 - I²C Interface with SMBus support
 - Address recognition in Stop Mode
- **Ultra low power precision analog peripherals**
 - 12-bit 1 Msamples/s Analog to Digital Converter
 - 8 single ended channels/4 differential channels
 - On-chip temperature sensor
 - Conversion tailgating for predictable latency
 - 12-bit 500 ksamples/s Digital to Analog Converter
 - 2 single ended channels/1 differential channel
 - 2x Analog Comparator
 - Programmable speed/current
 - Capacitive sensing with up to 8 inputs
 - 3x Operational Amplifier
 - 2.2MHz GBW, Rail-to-rail, Programmable Gain
 - Supply Voltage Comparator
- **Ultra efficient Power-on Reset and Brown-Out Detector**
- **2-pin Serial Wire Debug interface**
 - 1-pin Serial Wire Viewer
- **Temperature range -40 to 85 °C**
- **Single power supply 1.8 to 3.8 V**
- **QFN64 package**

EFM32TG840 microcontrollers are suited for all battery operated applications

Energy Metering



Industrial/ Home Automation

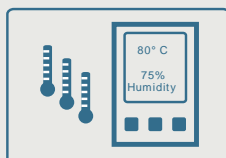

Wireless Alarm/ Security

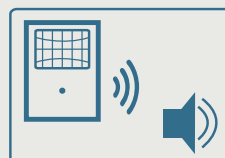

Medical Systems



1 Ordering Information

Table 1.1 (p. 2) shows the available EFM32TG840 devices.

Table 1.1. Ordering Information

Ordering Code	Flash (KB)	RAM (KB)	Max Speed (MHz)	Supply Voltage	Temperature	Package
EFM32TG840F8-QFN64	8	2	32	1.8 to 3.8V	-40 to 85 °C	QFN64
EFM32TG840F16-QFN64	16	4	32	1.8 to 3.8V	-40 to 85 °C	QFN64
EFM32TG840F32-QFN64	32	4	32	1.8 to 3.8V	-40 to 85 °C	QFN64

Visit www.energymicro.com for information on global distributors and representatives or contact sales@energymicro.com for additional information.

1.1 Block Diagram

A block diagram of the EFM32TG840 is shown in Figure 1.1 (p. 2) .

Figure 1.1. Block Diagram

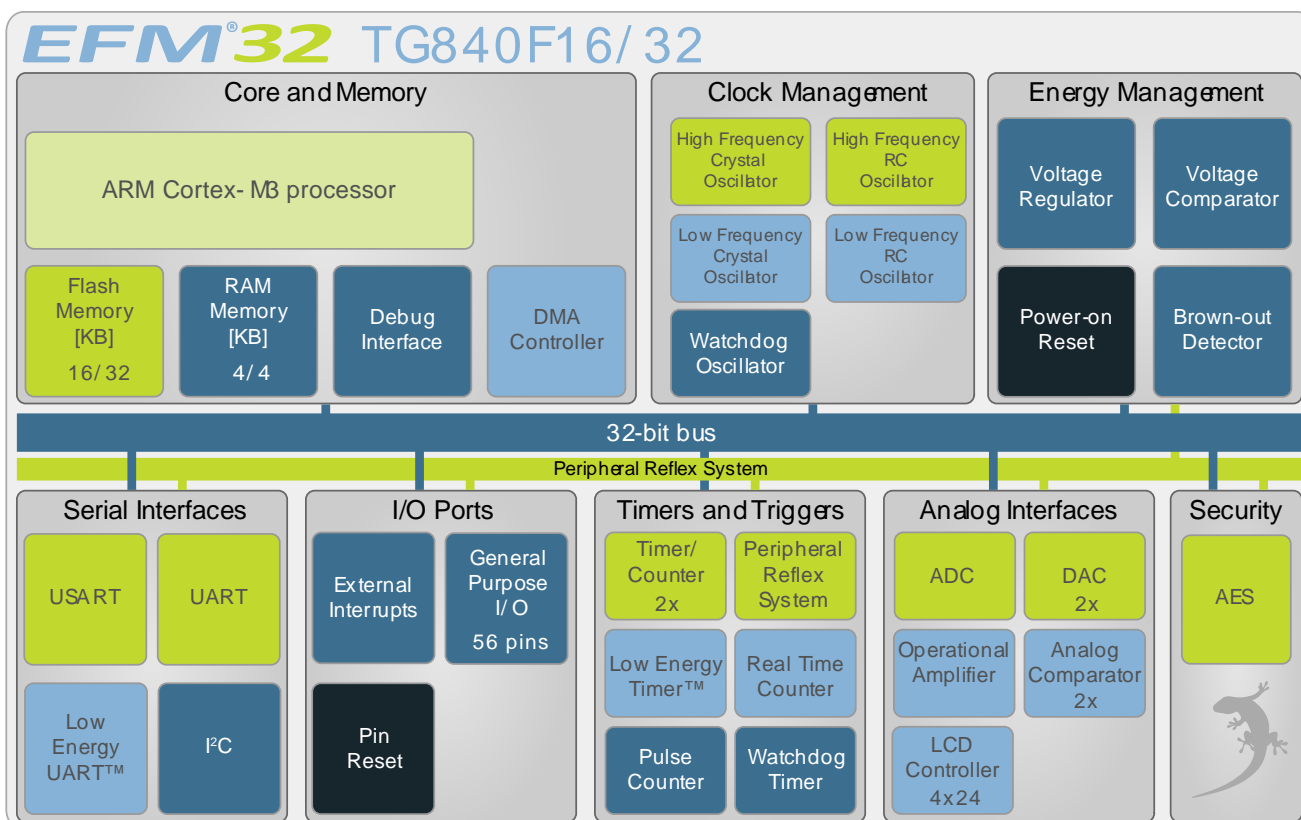

2 System Summary

2.1 System Introduction

The EFM32G family of MCUs is the world's most energy friendly microcontroller. With a unique combination of the powerful 32-bit ARM Cortex-M3, innovative low energy techniques, short wake-up time from energy saving modes, and a wide selection of peripherals, the EFM32G microcontroller is well suited for any battery operated application as well as other systems requiring high performance and low-energy consumption. This section gives a short introduction to each of the modules in general terms and also shows a summary of the configuration for the EFM32TG840 devices. For a complete feature set and in-depth information on the modules, the reader is referred to the *EFM32G Reference Manual*.

2.1.1 ARM Cortex-M3 Core

The ARM Cortex-M3 includes a 32-bit RISC processor which can achieve as much as 1.25 Dhrystone MIPS/MHz. A Memory Protection Unit with support for up to 8 memory segments is included, as well as a Wake-up Interrupt Controller handling interrupts triggered while the CPU is asleep. The EFM32 implementation of the Cortex-M3 is described in detail in *EFM32G Cortex-M3 Reference Manual*.

2.1.2 Debug Interface (DBG)

This device includes hardware debug support through a 2-pin serial-wire debug interface. In addition there is also a 1-wire Serial Wire Viewer pin which can be used to output profiling information, data trace and software-generated messages.

2.1.3 Memory System Controller (MSC)

The Memory System Controller (MSC) is the program memory unit of the EFM32G microcontroller. The flash memory is readable and writable from both the Cortex-M3 and DMA. The flash memory is divided into two blocks; the main block and the information block. Program code is normally written to the main block. Additionally, the information block is available for special user data and flash lock bits. There is also a read-only page in the information block containing system and device calibration data. Read and write operations are supported in the energy modes EM0 and EM1.

2.1.4 Direct Memory Access Controller (DMA)

The Direct Memory Access (DMA) controller performs memory operations independently of the CPU. This has the benefit of reducing the energy consumption and the workload of the CPU, and enables the system to stay in low energy modes when moving for instance data from the USART to RAM or from the External Bus Interface to the DAC. The DMA controller uses the PL230 μ DMA controller licensed from ARM.

2.1.5 Reset Management Unit (RMU)

The RMU is responsible for handling the reset functionality of the EFM32G.

2.1.6 Energy Management Unit (EMU)

The Energy Management Unit (EMU) manage all the low energy modes (EM) in EFM32G microcontrollers. Each energy mode manages if the CPU and the various peripherals are available. The EMU can also be used to turn off the power to unused SRAM blocks.

2.1.7 Clock Management Unit (CMU)

The Clock Management Unit (CMU) is responsible for controlling the oscillators and clocks on-board the EFM32G. The CMU provides the capability to turn on and off the clock on an individual basis to all peripheral modules in addition to enable/disable and configure the available oscillators. The high degree

of flexibility enables software to minimize energy consumption in any specific application by not wasting power on peripherals and oscillators that are inactive.

2.1.8 Watchdog (WDOG)

The purpose of the watchdog timer is to generate a reset in case of a system failure, to increase application reliability. The failure may e.g. be caused by an external event, such as an ESD pulse, or by a software failure.

2.1.9 Peripheral Reflex System (PRS)

The Peripheral Reflex System (PRS) system is a network which lets the different peripheral module communicate directly with each other without involving the CPU. Peripheral modules which send out Reflex signals are called producers. The PRS routes these reflex signals to consumer peripherals which apply actions depending on the data received. The format for the Reflex signals is not given, but edge triggers and other functionality can be applied by the PRS.

2.1.10 Inter-Integrated Circuit Interface (I2C)

The I²C module provides an interface between the MCU and a serial I²C-bus. It is capable of acting as both a master and a slave, and supports multi-master buses. Both standard-mode, fast-mode and fast-mode plus speeds are supported, allowing transmission rates all the way from 10 kbit/s up to 1 Mbit/s. Slave arbitration and timeouts are also provided to allow implementation of an SMBus compliant system. The interface provided to software by the I²C module, allows both fine-grained control of the transmission process and close to automatic transfers. Automatic recognition of slave addresses is provided in all energy modes.

2.1.11 Universal Synchronous/Asynchronous Receiver/Transmitter (USART)

The Universal Synchronous Asynchronous serial Receiver and Transmitter (USART) is a very flexible serial I/O module. It supports full duplex asynchronous UART communication as well as RS-485, SPI, MicroWire and 3-wire. It can also interface with ISO7816 SmartCards, and IrDA devices.

2.1.12 Universal Asynchronous Receiver/Transmitter (UART)

The Universal Asynchronous serial Receiver and Transmitter (UART) is a very flexible serial I/O module. It supports full- and half-duplex asynchronous UART communication.

2.1.13 Low Energy Universal Asynchronous Receiver/Transmitter (LEUART)

The unique LEUART[™], the Low Energy UART, is a UART that allows two-way UART communication on a strict power budget. Only a 32.768 kHz clock is needed to allow UART communication up to 9600 baud/s. The LEUART includes all necessary hardware support to make asynchronous serial communication possible with minimum of software intervention and energy consumption.

2.1.14 Timer/Counter (TIMER)

The 16-bit general purpose Timer has 3 compare/capture channels for input capture and compare/Pulse-Width Modulation (PWM) output. TIMER0 also includes a Dead-Time Insertion module suitable for motor control applications.

2.1.15 Real Time Counter (RTC)

The Real Time Counter (RTC) contains a 24-bit counter and is clocked either by a 32.768 kHz crystal oscillator, or a 32 kHz RC oscillator. In addition to energy modes EM0 and EM1, the RTC is also available

in EM2. This makes it ideal for keeping track of time since the RTC is enabled in EM2 where most of the device is powered down.

2.1.16 Low Energy Timer (LETIMER)

The unique LETIMER[™], the Low Energy Timer, is a 16-bit timer that is available in energy mode EM2 in addition to EM1 and EM0. Because of this, it can be used for timing and output generation when most of the device is powered down, allowing simple tasks to be performed while the power consumption of the system is kept at an absolute minimum. The LETIMER can be used to output a variety of waveforms with minimal software intervention. It is also connected to the Real Time Counter (RTC), and can be configured to start counting on compare matches from the RTC.

2.1.17 Pulse Counter (PCNT)

The Pulse Counter (PCNT) can be used for counting pulses on a single input or to decode quadrature encoded inputs. It runs off either the internal LFACTK or the PCNTn_S0IN pin as external clock source. The module may operate in energy mode EM0 – EM3.

2.1.18 Analog Comparator (ACMP)

The Analog Comparator is used to compare the voltage of two analog inputs, with a digital output indicating which input voltage is higher. Inputs can either be one of the selectable internal references or from external pins. Response time and thereby also the current consumption can be configured by altering the current supply to the comparator.

2.1.19 Voltage Comparator (VCMP)

The Voltage Supply Comparator is used to monitor the supply voltage from software. An interrupt can be generated when the supply falls below or rises above a programmable threshold. Response time and thereby also the current consumption can be configured by altering the current supply to the comparator.

2.1.20 Analog to Digital Converter (ADC)

The ADC is a Successive Approximation Register (SAR) architecture, with a resolution of up to 12 bits at up to one million samples per second. The integrated input mux can select inputs from >8 external pins and 6 internal signals.

2.1.21 Digital to Analog Converter (DAC)

The Digital to Analog Converter (DAC) can convert a digital value to an analog output voltage. The DAC is fully differential rail-to-rail, with 12-bit resolution. It has two single ended output buffers which can be combined into one differential output. The DAC may be used for a number of different applications such as sensor interfaces or sound output.

2.1.22 Operational Amplifier (OPAMP)

The EFM32TG840 features 3 Operational Amplifiers. The operational amplifier is a versatile general purpose amplifier with rail-to-rail differential input and rail-to-rail single ended output. The input can be set to pin, DAC or OPAMP, whereas the output can be pin, OPAMP or ADC. The current is programmable and the OPAMP has various internal configurations such as unity gain, programmable gain with internal resistors etc.

2.1.23 Advanced Encryption Standard Accelerator (AES)

The AES accelerator performs AES encryption and decryption with 128-bit or 256-bit keys. Encrypting or decrypting one 128-bit data block takes 52 HFCORECLK cycles with 128-bit keys and 75 HFCORECLK

cycles with 256-bit keys. The AES module is an AHB slave which enables efficient access to the data and key registers. All write accesses to the AES module must be 32-bit operations, i.e. 8- or 16-bit operations are not supported.

2.1.24 General Purpose Input/Output (GPIO)

In the EFM32TG840, there are 56 General Purpose Input/Output (GPIO) pins, which are divided into ports with up to 16 pins each. These pins can individually be configured as either an output or input. More advanced configurations like open-drain, filtering and drive strength can also be configured individually for the pins. The GPIO pins can also be overridden by peripheral pin connections, like Timer PWM outputs or USART communication, which can be routed to several locations on the device. The GPIO supports up to 16 asynchronous external pin interrupts, which enables interrupts from any pin on the device. Also, the input value of a pin can be routed through the Peripheral Reflex System to other peripherals.

2.1.25 Liquid Crystal Display Driver (LCD)

The LCD driver is capable of driving a segmented LCD display with up to 4x 24 segments. A voltage boost function enables it to provide the LCD display with higher voltage than the supply voltage for the device. In addition, an animation feature can run custom animations on the LCD display without any CPU intervention. The LCD driver can also remain active even in Energy Mode 2 and provides a Frame Counter interrupt that can wake-up the device on a regular basis for updating data.

2.2 Configuration Summary

The features of the EFM32TG840 is a subset of the feature set described in the EFM32G Reference Manual. Table 2.1 (p. 6) describes device specific implementation of the features.

Table 2.1. Configuration Summary

Module	Configuration	Pin Connections
Cortex-M3	Full configuration	NA
DBG	Full configuration	DBG_SWCLK, DBG_SWDIO, DBG_SWO
MSC	Full configuration	NA
DMA	Full configuration	NA
RMU	Full configuration	NA
EMU	Full configuration	NA
CMU	Full configuration	CMU_OUT0, CMU_OUT1
WDOG	Full configuration	NA
PRS	Full configuration	NA
I2C0	Full configuration	I2C0_SDA, I2C0_SCL
USART0	Full configuration	US0_TX, US0_RX, US0_CLK, US0_CS
UART0	Full configuration	U0_TX, U0_RX
LEUART0	Full configuration	LEU0_TX, LEU0_RX
TIMER0	Full configuration	TIM0_CC[2:0], TIM0_CDTI[2:0]
TIMER1	No DTI	TIM1_CC[2:0]
RTC	Full configuration	NA
LETIMER0	Full configuration	LET0_O[1:0]

Module	Configuration	Pin Connections
PCNT0	16-bit count register	PCNT0_S[1:0]
ACMP0	Full configuration	ACMP0_CH[7:4], ACMP0_O
ACMP1	Full configuration	ACMP1_CH[7:4], ACMP1_O
VCMP	Full configuration	NA
ADC0	Full configuration	ADC0_CH[7:0]
DAC0	Full configuration	DAC0_OUT[1:0]
OPAMP	x3	TBD
AES	Full configuration	NA
GPIO	56 pins	Available pins are shown in Table 4.3 (p. 45)
LCD	Full configuration	LCD_SEG[23:0], LCD_COM[3:0], LCD_BCAP_P, LCD_BCAP_N, LCD_BEXT

2.3 Memory Map

The EFM32TG840 memory map is shown in Figure 2.1 (p. 7), with RAM and Flash sizes for the largest memory configuration.

Figure 2.1. EFM32TG840 Memory Map with largest RAM and Flash sizes

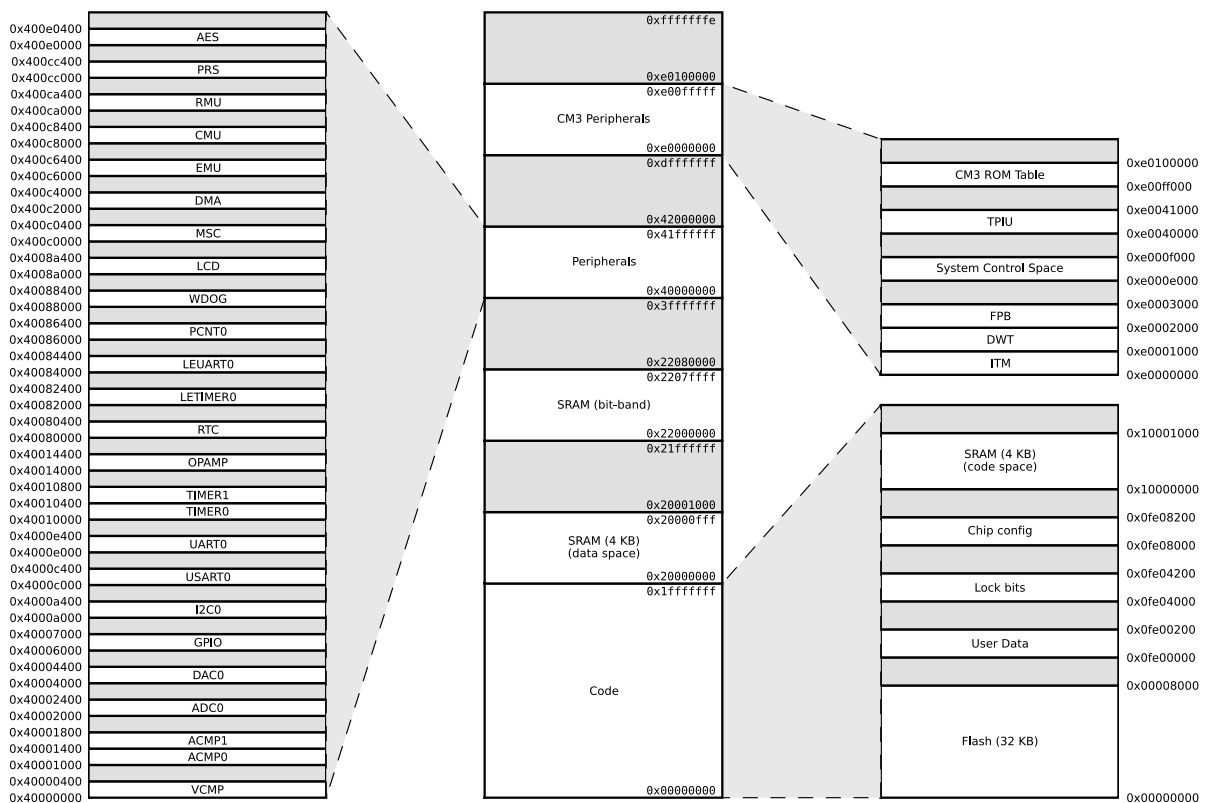

3 Electrical Characteristics

3.1 Test Conditions

3.1.1 Typical Values

The typical data are based on $T_{AMB}=25^{\circ}\text{C}$ and $V_{DD}=3.0\text{ V}$, as defined in Table 3.2 (p. 8), by simulation and/or technology characterisation unless otherwise specified.

3.1.2 Minimum and Maximum Values

The minimum and maximum values represent the worst conditions of ambient temperature, supply voltage and frequencies, as defined in Table 3.2 (p. 8), by simulation and/or technology characterisation unless otherwise specified.

3.2 Absolute Maximum Ratings

The absolute maximum ratings are stress ratings, and functional operation under such conditions are not guaranteed. Stress beyond the limits specified in Table 3.1 (p. 8) may affect the device reliability or cause permanent damage to the device. Functional operating conditions are given in Table 3.2 (p. 8).

Table 3.1. Absolute Maximum Ratings

Symbol	Parameter	Condition	Min	Typ	Max	Unit
T_{STG}	Storage temperature range		-40		85	$^{\circ}\text{C}$
T_J	Maximum junction temperature	JEDEC J-STD-020D			260	$^{\circ}\text{C}$
V_{DDMAX}	External main supply voltage		0		3.8	V
V_{IOPIN}	Voltage on any I/O pin		-0.3		$V_{DD}+0.3$	V

3.3 General Operating Conditions

3.3.1 General Operating Conditions

Table 3.2. General Operating Conditions

Symbol	Parameter	Min	Typ	Max	Unit
T_{AMB}	Ambient temperature range	-40	25	85	$^{\circ}\text{C}$
V_{DDOP}	Operating supply voltage	1.8	3.0	3.8	V
f_{APB}	Internal APB clock frequency			32	MHz
f_{AHB}	Internal AHB clock frequency			32	MHz

3.3.2 Environmental

Table 3.3. Environmental

Symbol	Parameter	Condition	Min	Typ	Max	Unit
V _{ESDHBM}	ESD (Human Body Model HBM)	T _{AMB} =25°C			2	kV
V _{ESDCDM}	ESD (Charged Device Model, CDM)	T _{AMB} =25°C			500	V
MSL	Moisture sensitivity level	JEDEC J-STD-20D. Level 3			168	hrs
LU	Latchup sensitivity	JESD78 Latchup test procedure. Class II level A.			85	°C

3.4 Current Consumption

Table 3.4. Current Consumption

Symbol	Parameter	Condition	Min	Typ	Max	Unit
I _{EM0}	EM0 current. No prescaling. Running prime number calculation code from Flash.	32 MHz HF XO, all peripheral clocks disabled, V _{DD} = 3.0 V		180		μA/MHz
		28 MHz HFRCO, all peripheral clocks disabled, V _{DD} = 3.0 V		181	235	μA/MHz
		21 MHz HFRCO, all peripheral clocks disabled, V _{DD} = 3.0 V		183	237	μA/MHz
		14 MHz HFRCO, all peripheral clocks disabled, V _{DD} = 3.0 V		185	243	μA/MHz
		11 MHz HFRCO, all peripheral clocks disabled, V _{DD} = 3.0 V		186	246	μA/MHz
		7 MHz HFRCO, all peripheral clocks disabled, V _{DD} = 3.0 V		191	257	μA/MHz
		1 MHz HFRCO, all peripheral clocks disabled, V _{DD} = 3.0 V		220		μA/MHz
I _{EM1}	EM1 current	32 MHz HF XO, all peripheral clocks disabled, V _{DD} = 3.0 V		45		μA/MHz
		28 MHz HFRCO, all peripheral clocks disabled, V _{DD} = 3.0 V		47	62	μA/MHz
		21 MHz HFRCO, all peripheral clocks disabled, V _{DD} = 3.0 V		48	64	μA/MHz
		14 MHz HFRCO, all peripheral clocks disabled, V _{DD} = 3.0 V		50	69	μA/MHz
		11 MHz HFRCO, all peripheral clocks disabled, V _{DD} = 3.0 V		51	72	μA/MHz
		7 MHz HFRCO, all peripheral clocks disabled, V _{DD} = 3.0 V		56	83	μA/MHz
		1 MHz HFRCO. all peripheral clocks disabled, V _{DD} = 3.0 V		103		μA/MHz
I _{EM2}	EM2 current	EM2 current with RTC at 1 Hz, RTC prescaled to 1kHz, 32 kHz LFRCO, V _{DD} = 3.0 V, T _{AMB} =25°C		0.9		μA
		EM2 current with RTC at 1 Hz, RTC prescaled to 1kHz, 32 kHz LFRCO, V _{DD} = 3.0 V, T _{AMB} =85°C		3.0	6.0	μA
I _{EM3}	EM3 current	V _{DD} = 3.0 V, T _{AMB} =25°C		0.59		μA
		V _{DD} = 3.0 V, T _{AMB} =85°C		2.75	5.8	μA
I _{EM4}	EM4 current	V _{DD} = 3.0 V, T _{AMB} =25°C		0.02		μA
		V _{DD} = 3.0 V, T _{AMB} =85°C		0.25	0.7	μA

Figure 3.1. EM0 Current consumption vs supply voltage, executing prime number calculation code from flash with HFRCO running at 28MHz

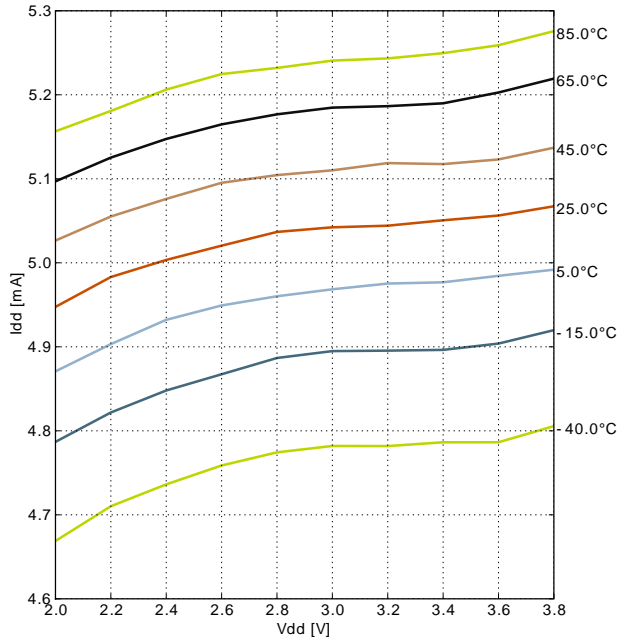

Figure 3.2. EM0 Current consumption vs temperature, executing prime number calculation code from flash with HFRCO running at 28MHz

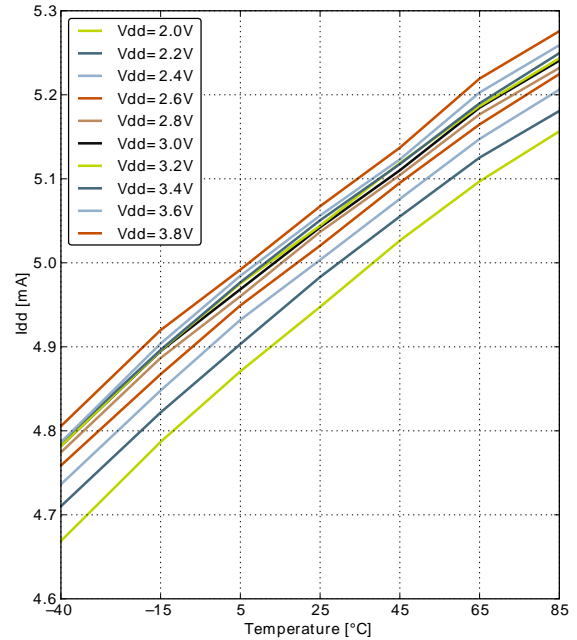

Figure 3.3. EM0 Current consumption vs supply voltage, executing prime number calculation code from flash with HFRCO running at 21MHz

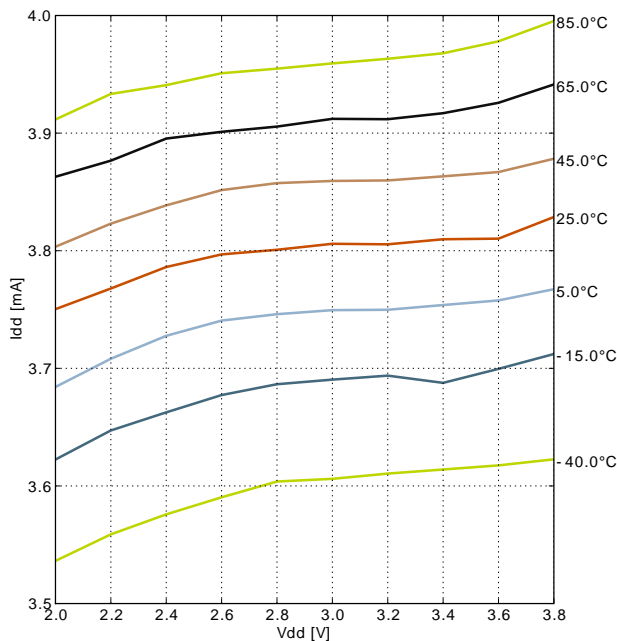

Figure 3.4. EM0 Current consumption vs temperature, executing prime number calculation code from flash with HFRCO running at 21MHz

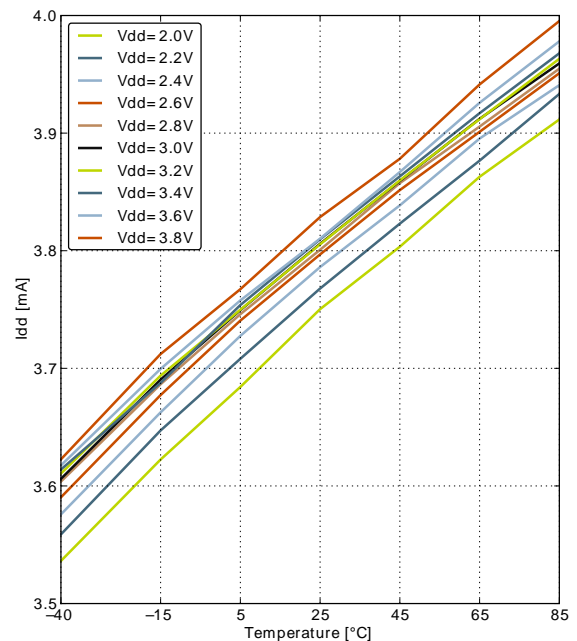

Figure 3.5. EM0 Current consumption vs supply voltage, executing prime number calculation code from flash with HFRCO running at 14MHz

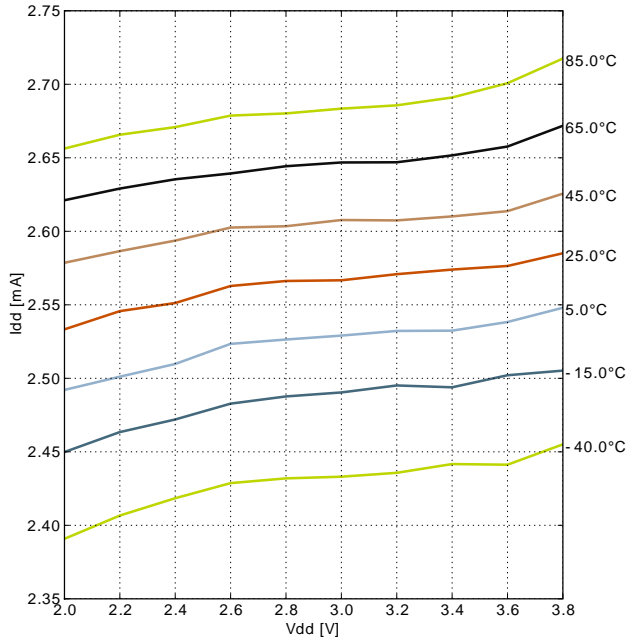

Figure 3.6. EM0 Current consumption vs temperature, executing prime number calculation code from flash with HFRCO running at 14MHz

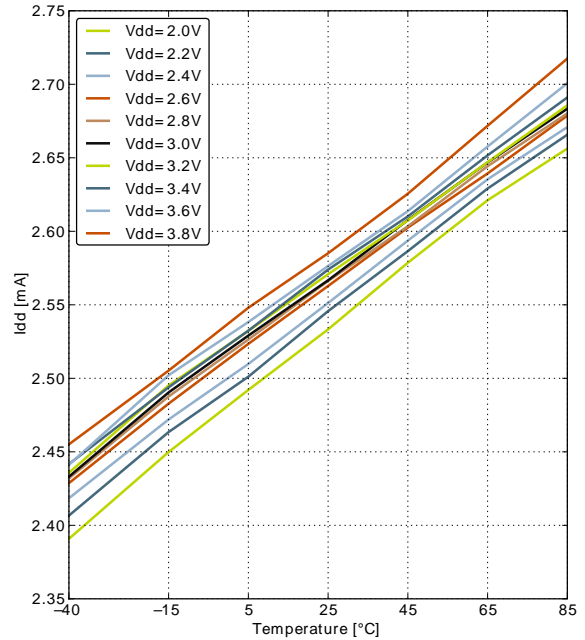

Figure 3.7. EM0 Current consumption vs supply voltage, executing prime number calculation code from flash with HFRCO running at 11MHz

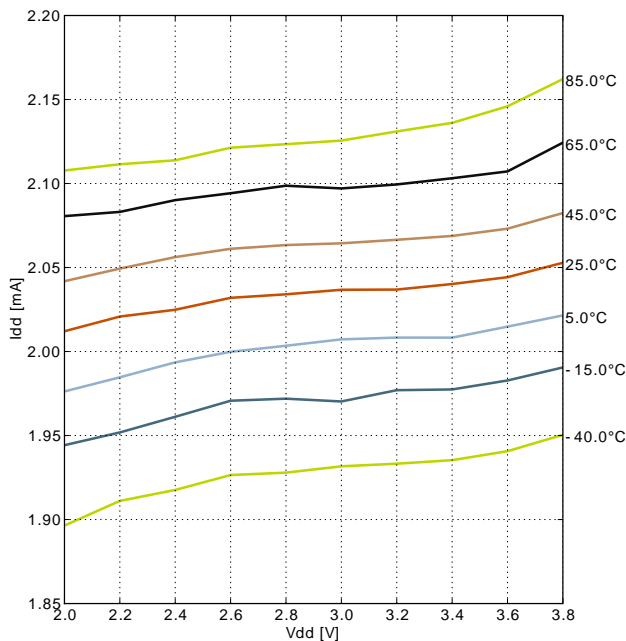

Figure 3.8. EM0 Current consumption vs temperature, executing prime number calculation code from flash with HFRCO running at 11MHz

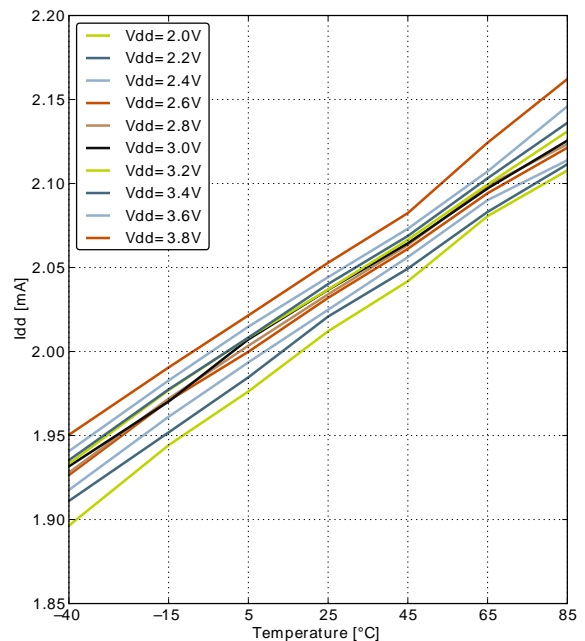

Figure 3.9. EM0 Current consumption vs supply voltage, executing prime number calculation code from flash with HFRCO running at 7MHz

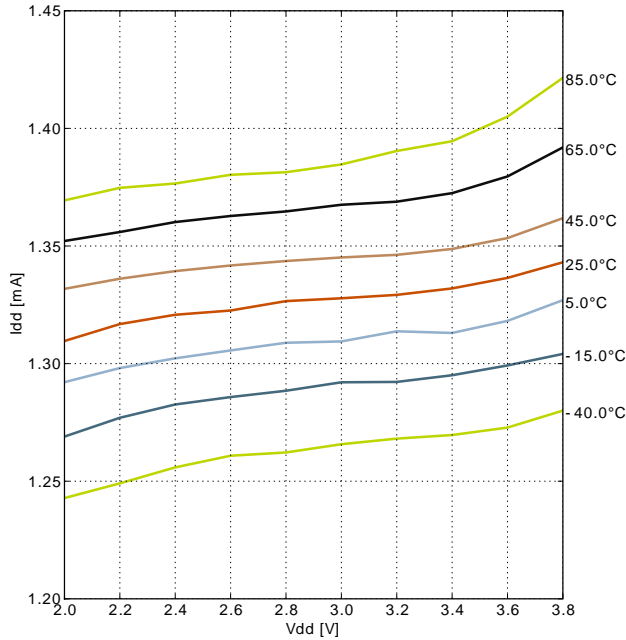

Figure 3.10. EM0 Current consumption vs temperature, executing prime number calculation code from flash with HFRCO running at 7MHz

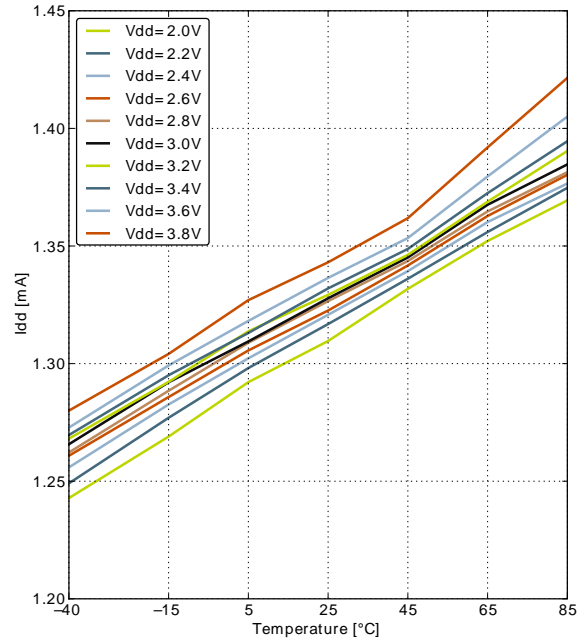

Figure 3.11. EM1 Current consumption vs supply voltage, all peripheral clocks disabled, HFRCO running at 28MHz

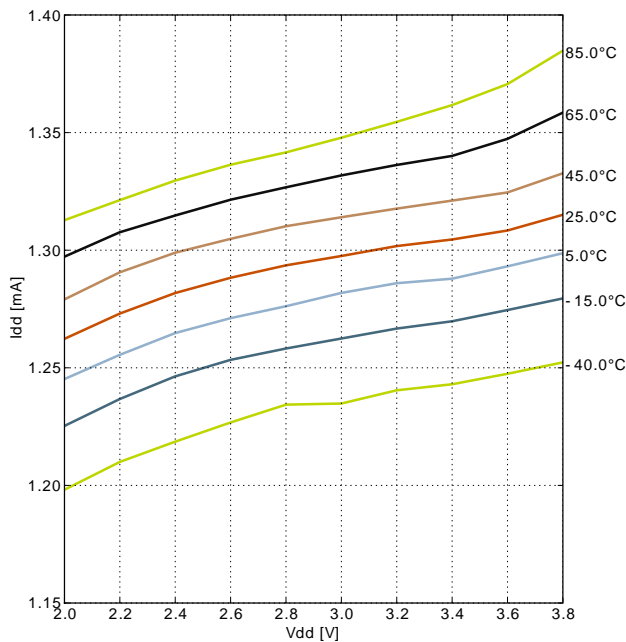

Figure 3.12. EM1 Current consumption vs temperature, all peripheral clocks disabled, HFRCO running at 28MHz

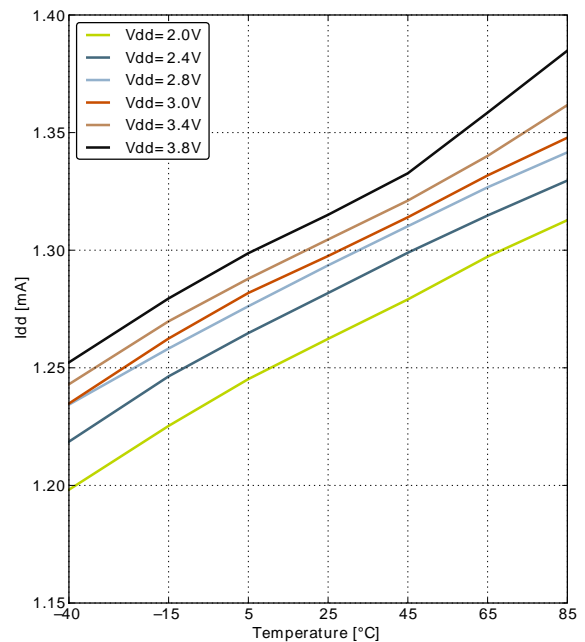

Figure 3.13. EM1 Current consumption vs supply voltage, all peripheral clocks disabled, HFRCO running at 21MHz

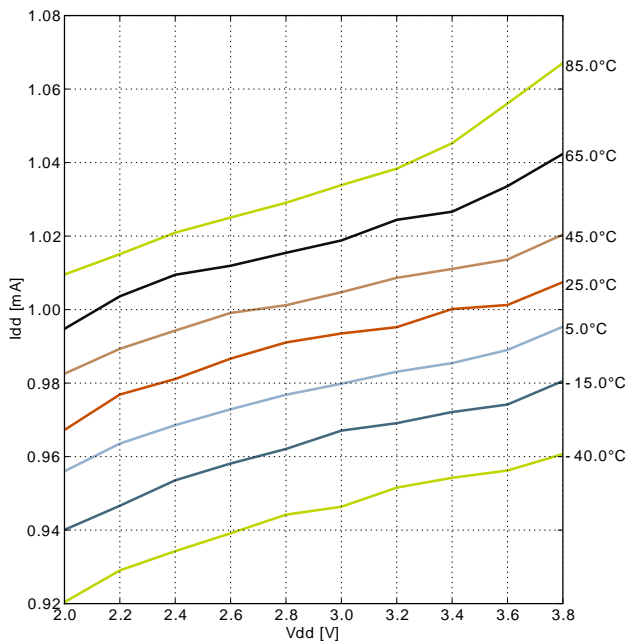

Figure 3.14. EM1 Current consumption vs temperature, all peripheral clocks disabled, HFRCO running at 21MHz

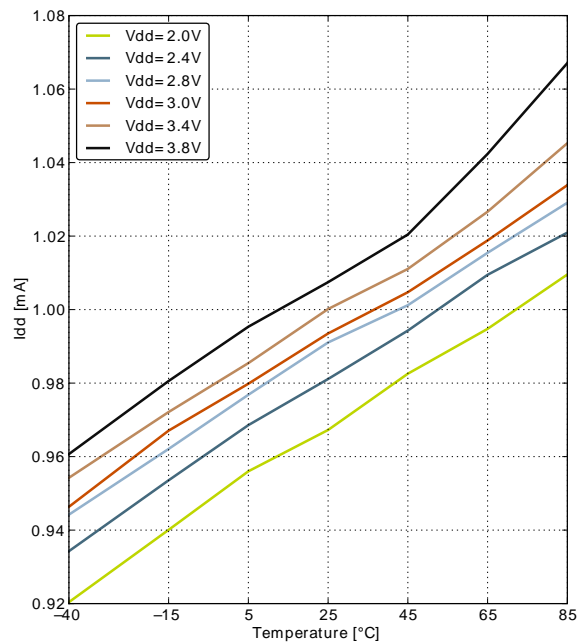

Figure 3.15. EM1 Current consumption vs supply voltage, all peripheral clocks disabled, HFRCO running at 14MHz

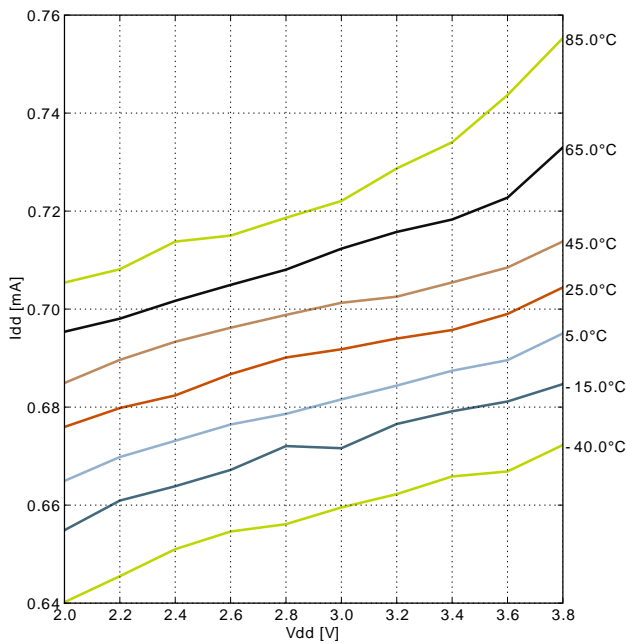

Figure 3.16. EM1 Current consumption vs temperature, all peripheral clocks disabled, HFRCO running at 14MHz

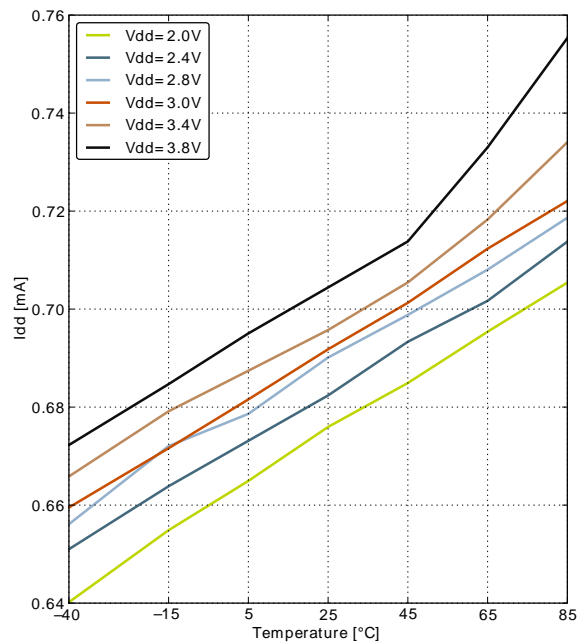

Figure 3.17. EM1 Current consumption vs supply voltage, all peripheral clocks disabled, HFRCO running at 11MHz

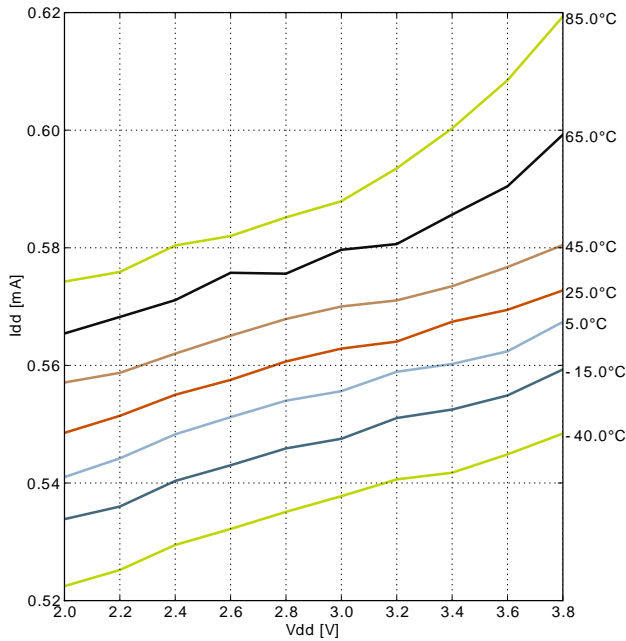

Figure 3.18. EM1 Current consumption vs temperature, all peripheral clocks disabled, HFRCO running at 11MHz

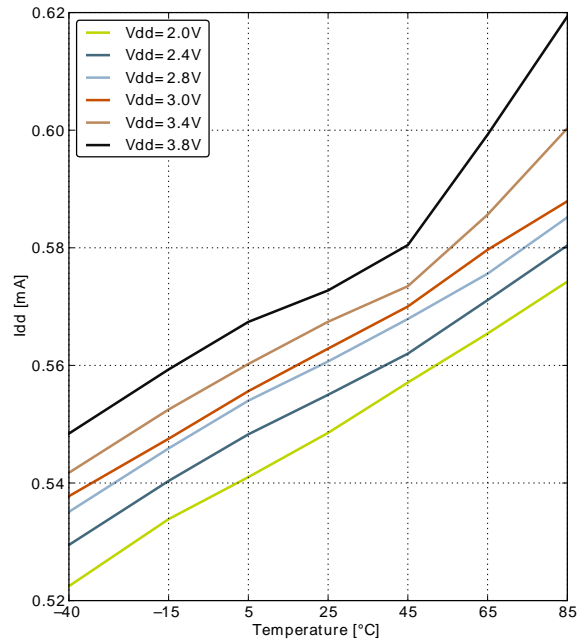

Figure 3.19. EM1 Current consumption vs supply voltage, all peripheral clocks disabled, HFRCO running at 7MHz

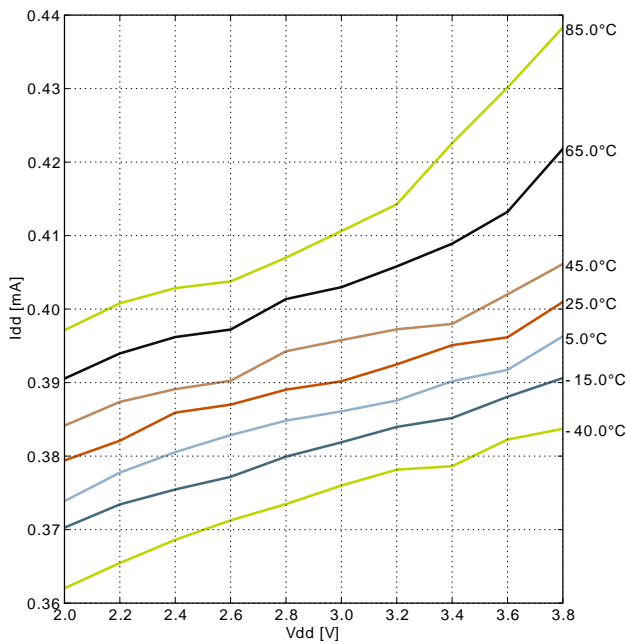

Figure 3.20. EM1 Current consumption vs temperature, all peripheral clocks disabled, HFRCO running at 7MHz

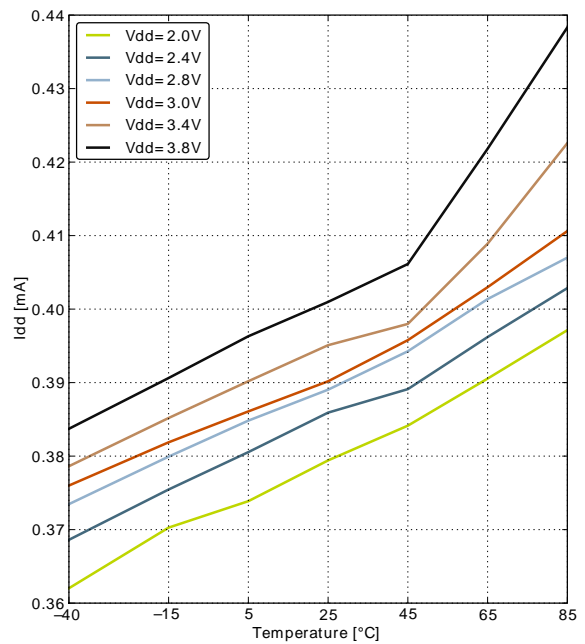

Figure 3.21. EM2 Current consumption vs supply voltage. RTC incremented each temperature. RTC incremented each second, second, RTC prescaled to 1kHz, 32 kHz LFRCO.

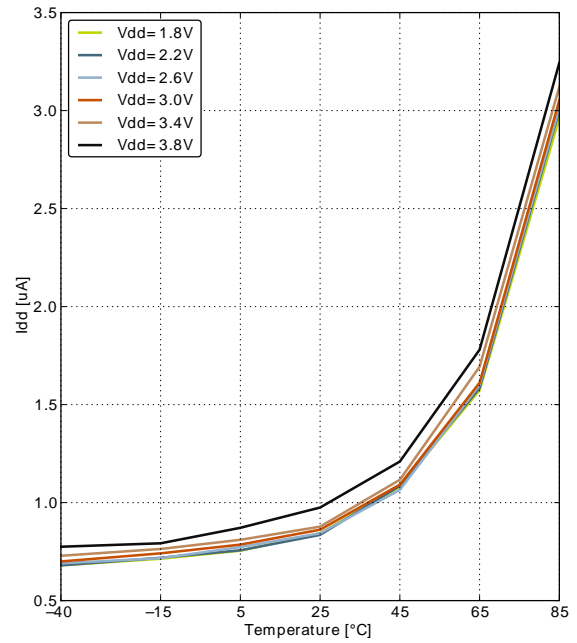
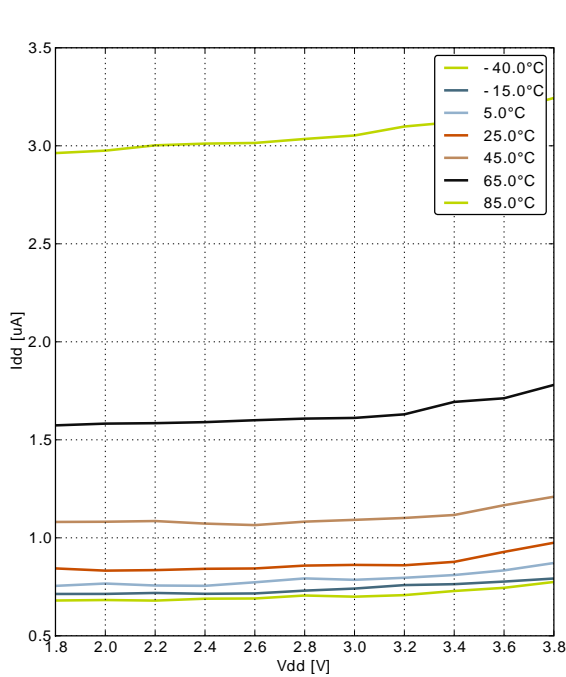

Figure 3.23. EM3 Current consumption vs supply voltage

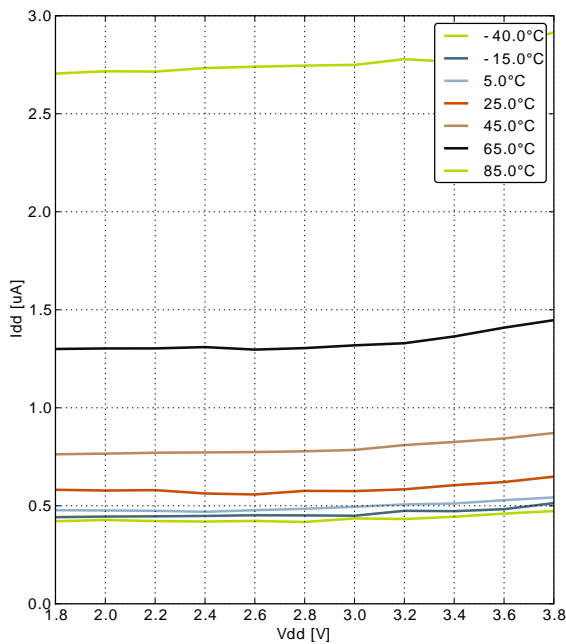

Figure 3.24. EM3 Current consumption vs temperature

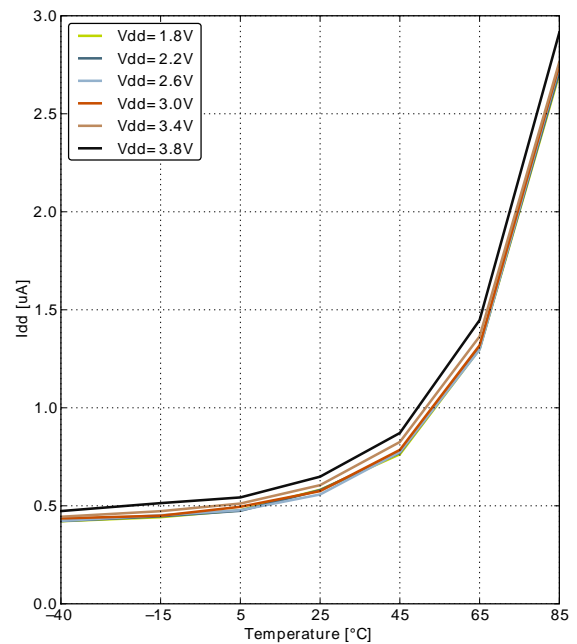
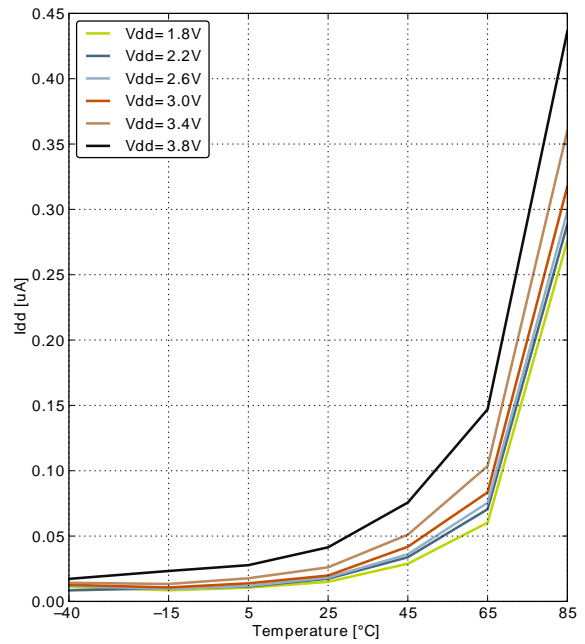
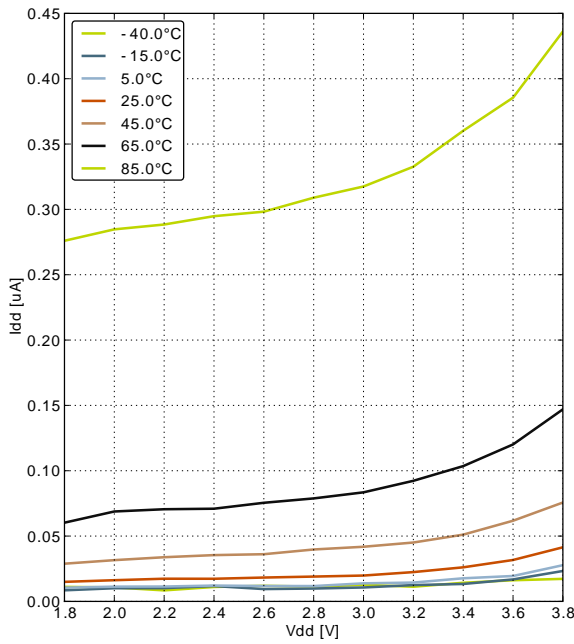

Figure 3.25. EM4 Current consumption vs Figure 3.26. EM4 Current consumption vs supply voltage **vs temperature**



3.5 Transition between Energy Modes

Table 3.5. Energy Modes Transitions

Symbol	Parameter	Condition	Min	Typ	Max	Unit
t_{EM10}	Transition time from EM1 to EM0			0 ¹		HF core CLK cycles
t_{EM20}	Transition time from EM2 to EM0			2		μ s
t_{EM30}	Transition time from EM3 to EM0			2		μ s
t_{EM40}	Transition time from EM4 to EM0			163		μ s

¹Core wakeup time only.

3.6 Power Management

Table 3.6. Power Management

Symbol	Parameter	Condition	Min	Typ	Max	Unit
$V_{BODextthr-}$	BOD threshold on falling external supply voltage		1.77		1.80	V
$V_{BODintthr-}$	BOD threshold on falling internally regulated supply voltage		1.62		1.65	V
$V_{BODextthr+}$	BOD threshold on rising external supply voltage	Uncalibrated		1.82		V
$V_{BODexthyst}$	BOD hysteresis on external supply voltage			150		mV
TC_{BGR}	Temperature coefficient of band-gap reference (BGR)	Relative voltage variation in EM0 based on the difference in V_{ref} between -40°C and 85°C.			0.55	%
t_{RESET}	Delay from reset is released until program execution starts	Applies to Power-on Reset, Brown-out Reset and pin reset.		163		μs
$C_{DECOUPLE}$	Voltage regulator decoupling capacitor.	X5R capacitor recommended. Apply between DECOUPLE pin and GROUND		1		μF

3.7 Flash

Table 3.7. Flash

Symbol	Parameter	Condition	Min	Typ	Max	Unit
EC_{FLASH}	Flash erase cycles before failure		20000			cycles
RET_{FLASH}	Flash data retention	$T_{AMB} < 85^{\circ}C$	10			years
t_{W_PROG}	Word (32-bit) programming time		20			μs
t_{P_ERASE}	Page erase time		20	20.4	20.8	ms
t_{D_ERASE}	Device erase time		40	40.8	41.6	ms

3.8 General Purpose Input Output

Table 3.8. GPIO

Symbol	Parameter	Condition	Min	Typ	Max	Unit
V_{IOIL}	Input low voltage				$0.3V_{DD}$	V
V_{IOIH}	Input high voltage		$0.7V_{DD}$			V
V_{IOOH}	Output high voltage relative to V_{DD}	Sourcing 6 mA, $V_{DD}=1.8V$	75			%
		Sourcing 6 mA, $V_{DD}=3.0V$	95			%
		Sourcing 20 mA, $V_{DD}=1.8V$	70			%
		Sourcing 20 mA, $V_{DD}=3.0V$	90			%
V_{IOOL}	Output low voltage relative to V_{DD}	Sinking 6 mA, $V_{DD}=1.8V$			25	%
		Sinking 6 mA, $V_{DD}=3.0V$			5	%
		Sinking 20 mA, $V_{DD}=1.8V$			30	%
		Sinking 20 mA, $V_{DD}=3.0V$			10	%
R_{PU}	I/O pin pull-up resistor			40		kOhm
R_{PD}	I/O pin pull-down resistor			40		kOhm
R_{IOESD}	Internal ESD series resistor			200		Ohm
$t_{IOGLITCH}$	Pulse width of pulses to be removed by the glitch suppression filter		10		50	ns
t_{IOOF}	Output fall time	0.5 mA drive strength and load capacitance $C_L=12.5-25pF$.	$20+0.1C_L$		250	ns
		2mA drive strength and load capacitance $C_L=350-600pF$	$20+0.1C_L$		250	ns
V_{IOHYST}	I/O pin hysteresis (V_{IOTHR+} - V_{IOTHR-})	$V_{DD} = 1.8 - 3.8 V$	$0.1V_{DD}$			V

3.8.1 Typical Low-Level Output Current, 2V supply voltage

Figure 3.27. Port output current, 0.5 mA Drive Strength

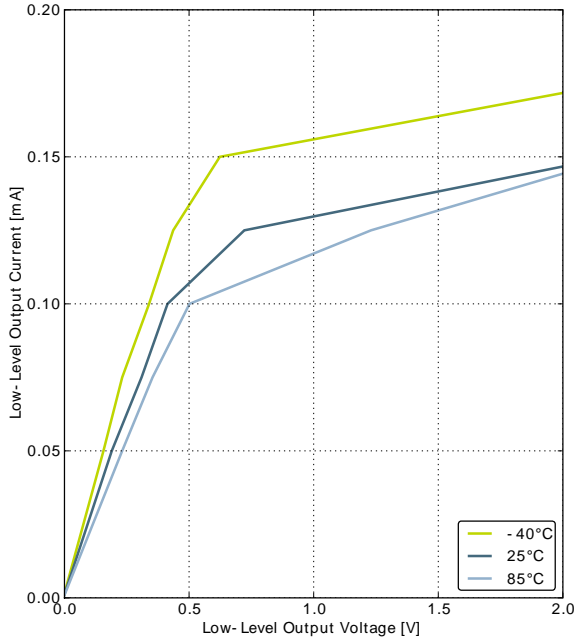

Figure 3.28. Port output current, 2 mA Drive Strength

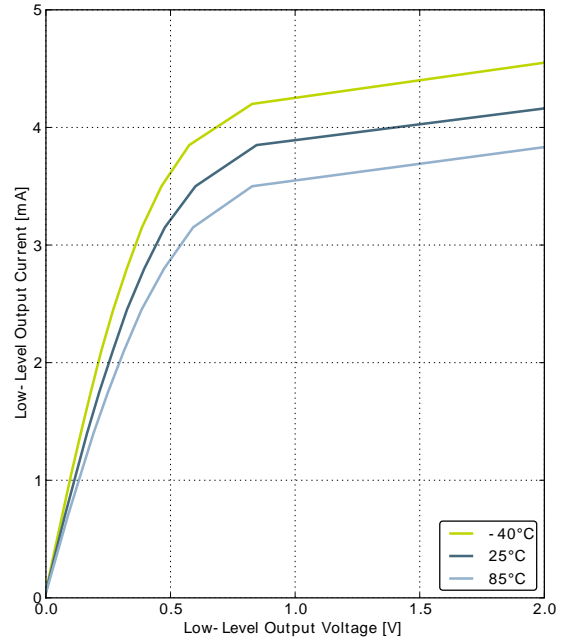

Figure 3.29. Port output current, 6 mA Drive Strength

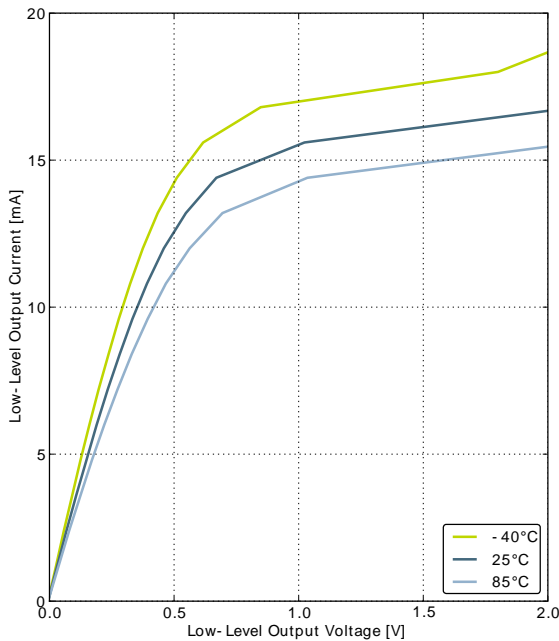
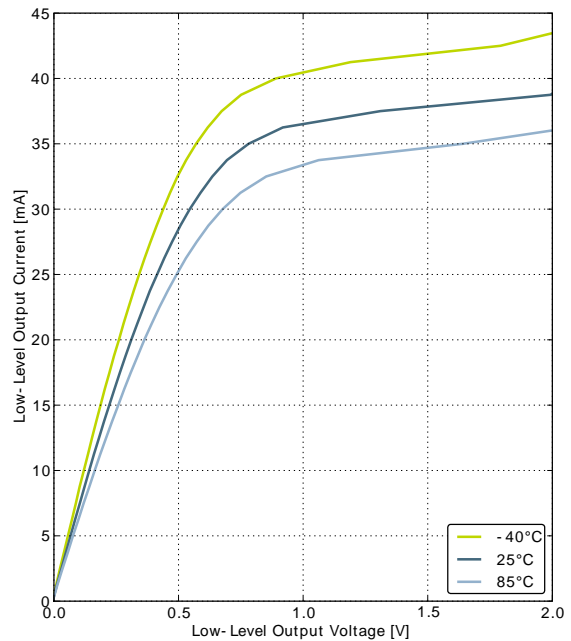

Figure 3.30. Port output current, 20 mA Drive Strength



3.8.2 Typical High-Level Output Current, 2V supply voltage

Figure 3.31. Port output current, 0.5 mA Drive Strength

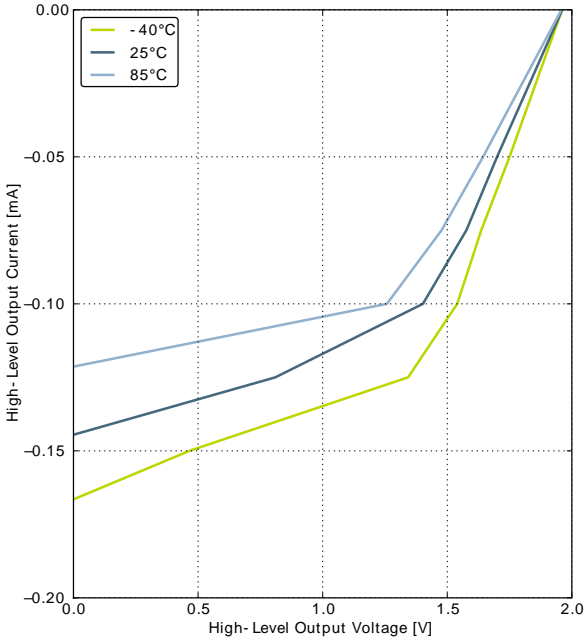

Figure 3.32. Port output current, 2 mA Drive Strength

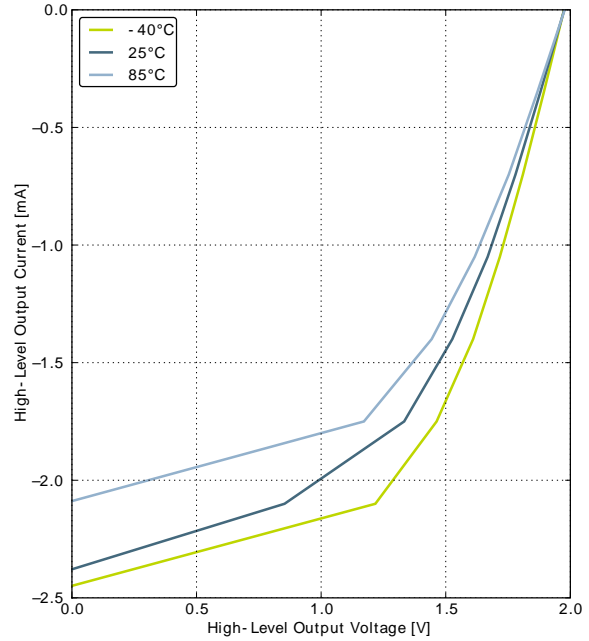

Figure 3.33. Port output current, 6 mA Drive Strength

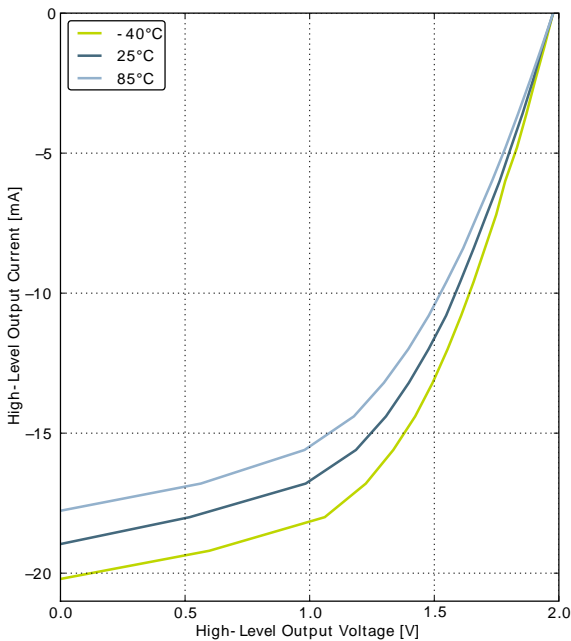
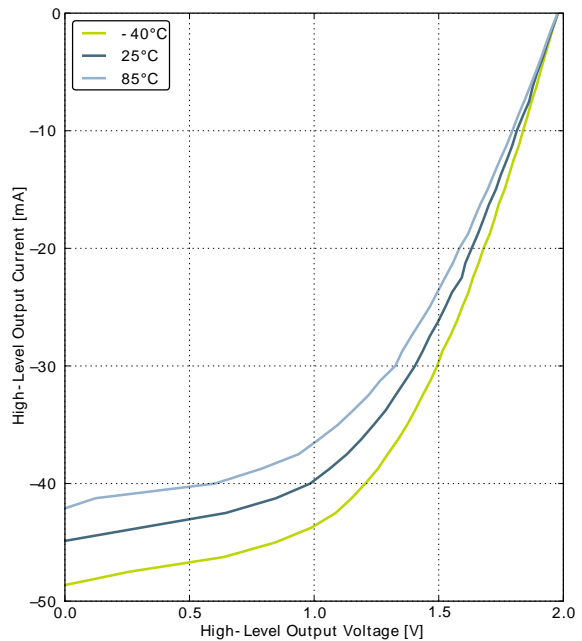

Figure 3.34. Port output current, 20 mA Drive Strength



3.8.3 Typical Low-Level Output Current, 3V supply voltage

Figure 3.35. Port output current, 0.5 mA Drive Strength

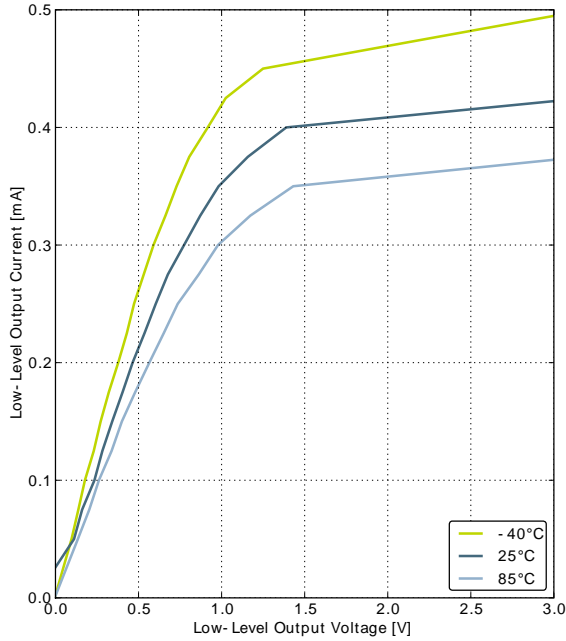

Figure 3.36. Port output current, 2 mA Drive Strength

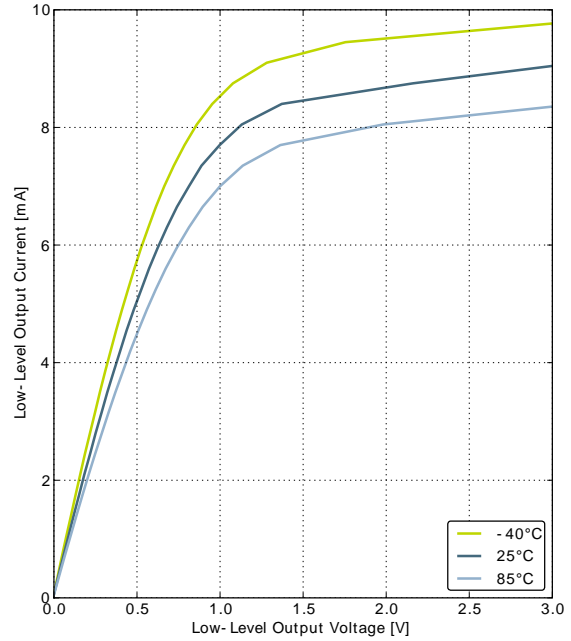

Figure 3.37. Port output current, 6 mA Drive Strength

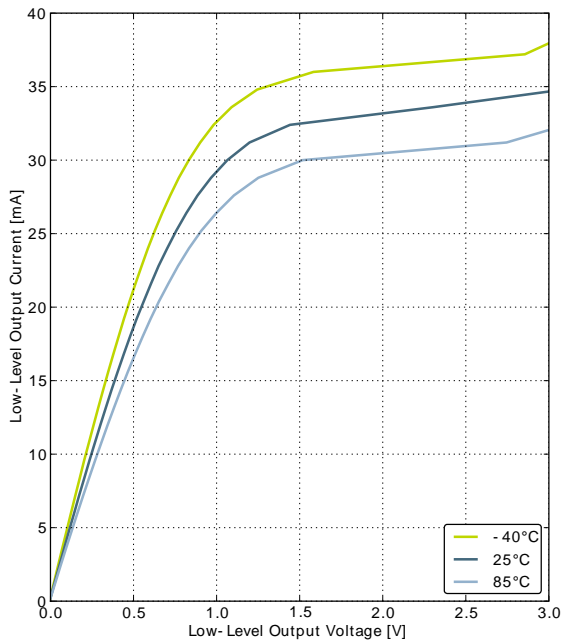
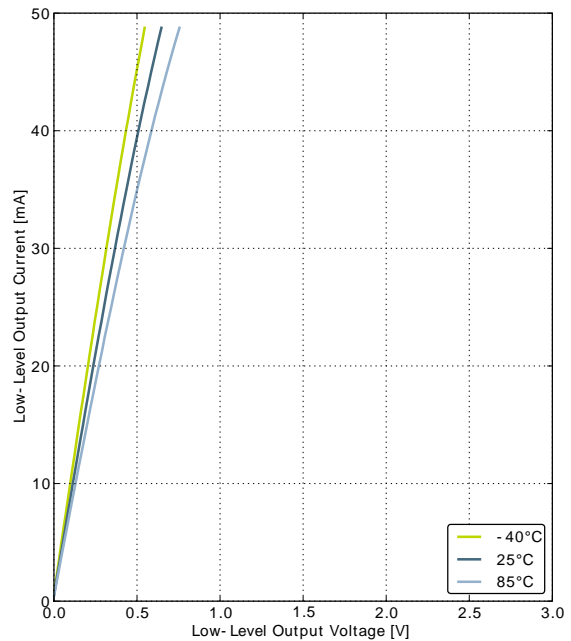

Figure 3.38. Port output current, 20 mA Drive Strength



3.8.4 Typical High-Level Output Current, 3V supply voltage

Figure 3.39. Port output current, 0.5 mA Drive Strength

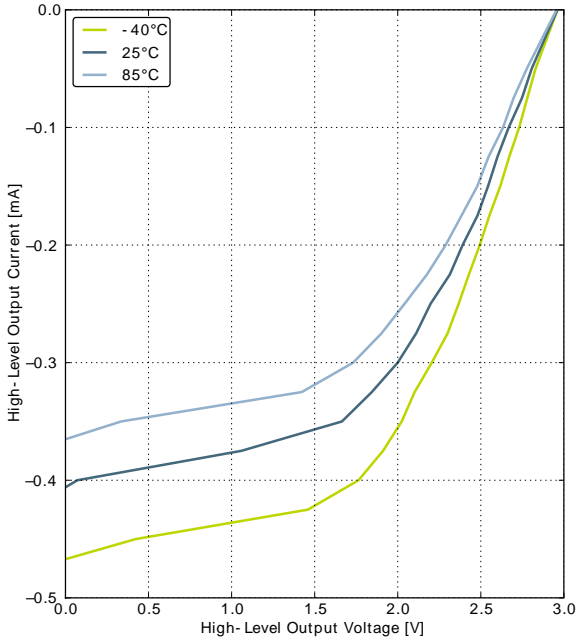

Figure 3.40. Port output current, 2 mA Drive Strength

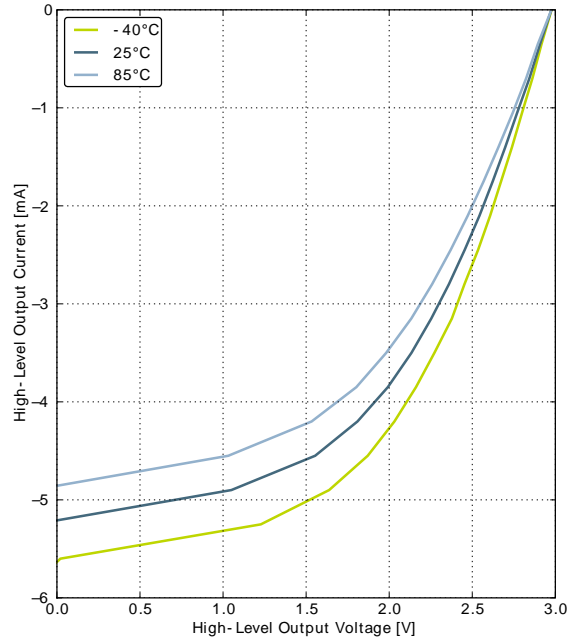

Figure 3.41. Port output current, 6 mA Drive Strength

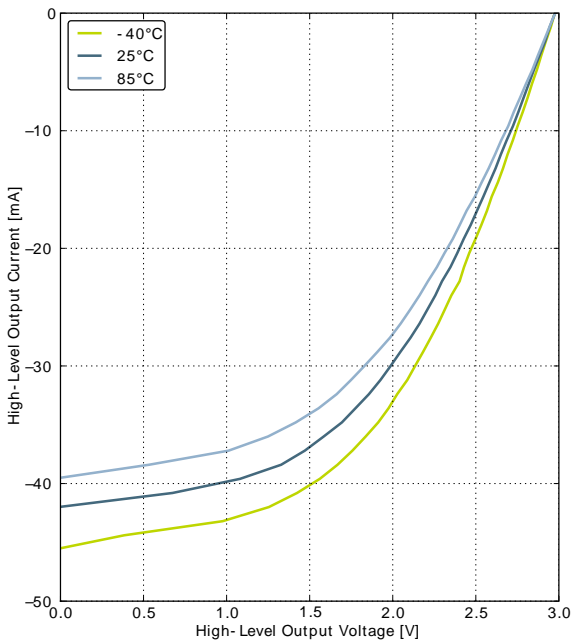
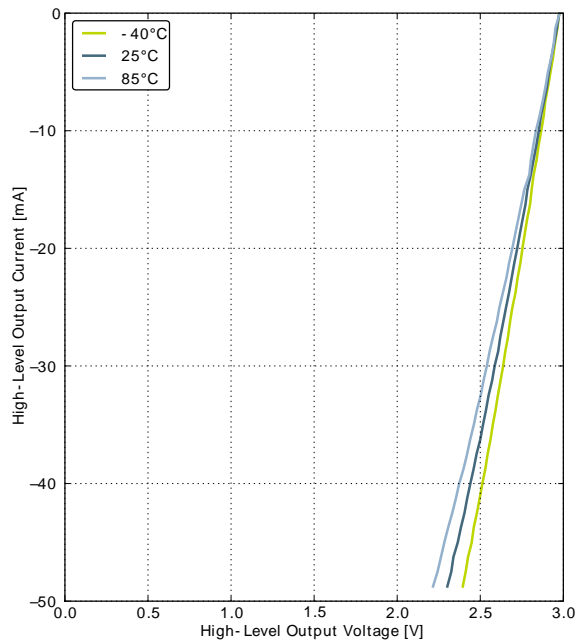

Figure 3.42. Port output current, 20 mA Drive Strength



3.8.5 Typical Low-Level Output Current, 3.8V supply voltage

Figure 3.43. Port output current, 0.5 mA Drive Strength

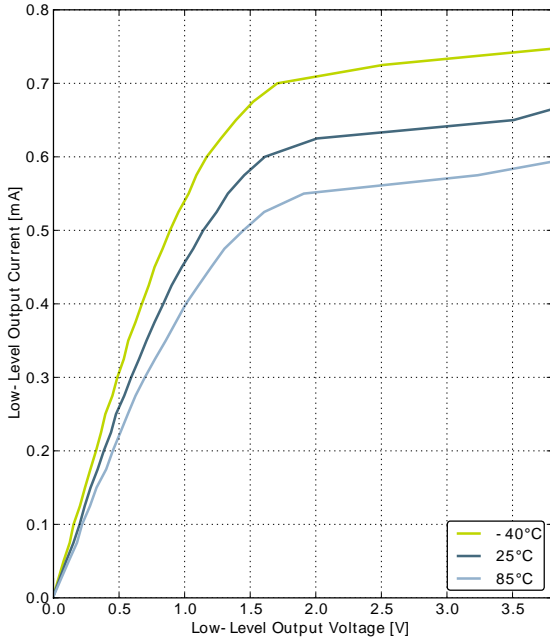

Figure 3.44. Port output current, 2 mA Drive Strength

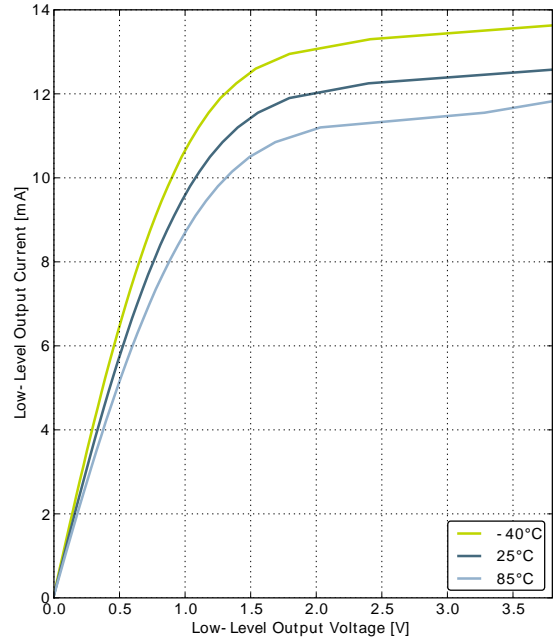

Figure 3.45. Port output current, 6 mA Drive Strength

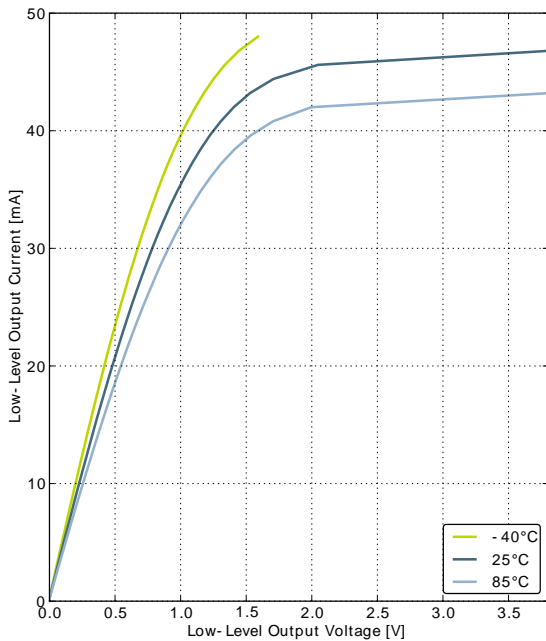
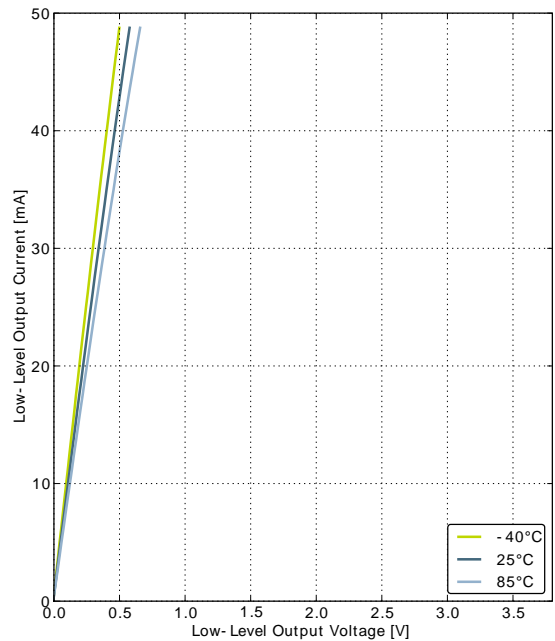

Figure 3.46. Port output current, 20 mA Drive Strength



3.8.6 Typical High-Level Output Current, 3.8V supply voltage

Figure 3.47. Port output current, 0.5 mA Drive Strength

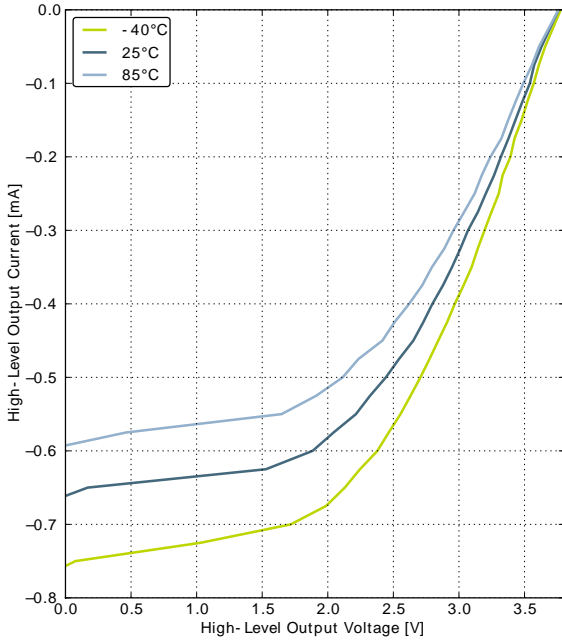

Figure 3.48. Port output current, 2 mA Drive Strength

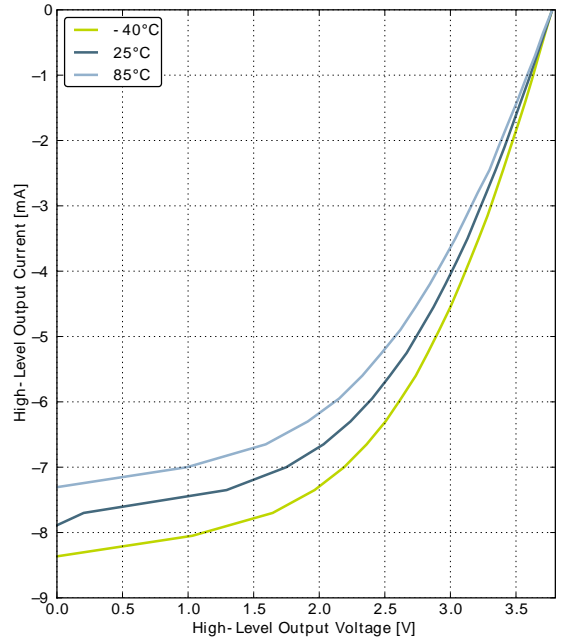

Figure 3.49. Port output current, 6 mA Drive Strength

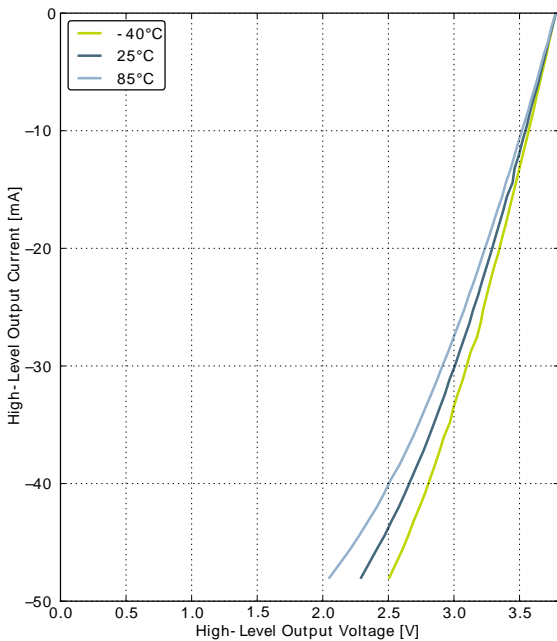
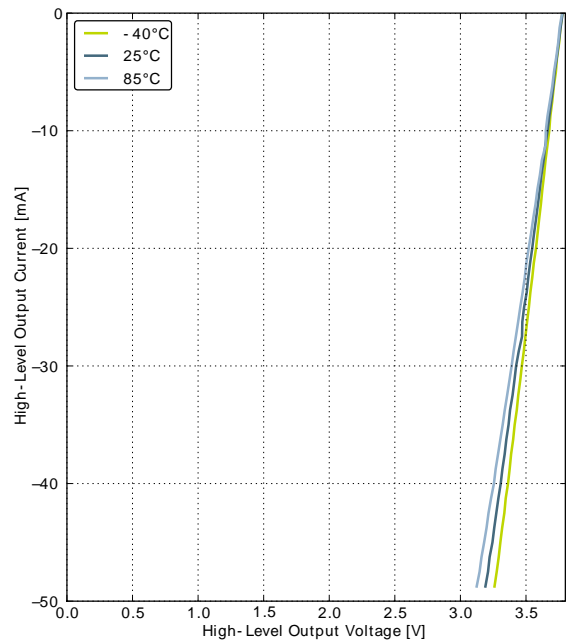

Figure 3.50. Port output current, 20 mA Drive Strength



3.9 Oscillators

3.9.1 LFXO

Table 3.9. LFXO

Symbol	Parameter	Condition	Min	Typ	Max	Unit
f_{LFXO}	Crystal frequency			32.768		kHz
ESR_{LFXO}	Supported crystal equivalent series resistance (ESR)			30	120	kOhm
C_{LFXOL}	Supported crystal external load range		5		25	pF
DC_{LFXO}	Duty cycle		48	50	53.5	%
I_{LFXO}	Current consumption for core and buffer after start-up.	ESR=30 kOhm, $C_L=10$ pF, LFXOBOOST in CMU_CTRL is 1		190		nA
t_{LFXO}	Start- up time.	ESR=30 kOhm, $C_L=10$ pF, 40% - 60% duty cycle has been reached, LFXOBOOST in CMU_CTRL is 1		400		ms

3.9.2 HFXO

Table 3.10. HFXO

Symbol	Parameter	Condition	Min	Typ	Max	Unit
f_{HFXO}	Crystal Frequency		4		32	MHz
ESR_{HFXO}	Supported crystal equivalent series resistance (ESR)	Crystal frequency 32 MHz		30	60	Ohm
		Crystal frequency 4 MHz		400	1500	Ohm
g_{mHFXO}	The transconductance of the HFXO input transistor at crystal startup	HFXOBOOST in CMU_CTRL equals 0b11	20			mS
C_{HFXOL}	Supported crystal external load range		5		25	pF
DC_{HFXO}	Duty cycle		46	50	54	%
I_{HFXO}	Current consumption for HFXO after startup	4 MHz: ESR=400 Ohm, $C_L=20$ pF, HFXOBOOST in CMU_CTRL equals 0b11		85		μ A
		32 MHz: ESR=30 Ohm, $C_L=10$ pF, HFXOBOOST in CMU_CTRL equals 0b11		165		μ A
t_{HFXO}	Startup time	32 MHz: ESR=30 Ohm, $C_L=10$ pF, HFXOBOOST in CMU_CTRL equals 0b11		400		μ s

3.9.3 LFRCO

Table 3.11. LFRCO

Symbol	Parameter	Condition	Min	Typ	Max	Unit
f_{LFRCO}	Oscillation frequency			32		kHz
t_{LFRCO}	Startup time not including software calibration			150		μ s
I_{LFRCO}	Current consumption			190		nA
TUNESTEP _{L-FR} FRCO	Frequency step for LSB change in TUNING value			1.5		%

3.9.4 HFRCO

Table 3.12. HFRCO

Symbol	Parameter	Condition	Min	Typ	Max	Unit
f_{HFRCO}	Oscillation frequency	28 MHz frequency band		28		MHz
		21 MHz frequency band		21		MHz
		14 MHz frequency band		14		MHz
		11 MHz frequency band		11		MHz
		7 MHz frequency band		7		MHz
		1 MHz frequency band		1		MHz
t_{HFRCO}	Start-up time not including software calibration	$f_{HFRCO} = 14$ MHz		0.6		μ s
I_{HFRCO}	Current consumption	$f_{HFRCO} = 28$ MHz		106		μ A
		$f_{HFRCO} = 21$ MHz		93		μ A
		$f_{HFRCO} = 14$ MHz		77		μ A
		$f_{HFRCO} = 11$ MHz		72		μ A
		$f_{HFRCO} = 7$ MHz		63		μ A
DC _{HFRCO}	Duty cycle	$f_{HFRCO} = 14$ MHz	48.5	50	51	%
TUNESTEP _{H-FR} FRCO	Frequency step for LSB change in TUNING value			0.3		%

3.9.5 ULFRCO

Table 3.13. ULFRCO

Symbol	Parameter	Condition	Min	Typ	Max	Unit
f_{ULFRCO}	Oscillation frequency	25°C, 3V	0.8		1.5	kHz
TC _{ULFRCO}	Temperature coefficient			0.05		%/°C
VC _{ULFRCO}	Supply voltage coefficient			-18.2		%/V

3.10 Analog Digital Converter (ADC)

Table 3.14. ADC

Symbol	Parameter	Condition	Min	Typ	Max	Unit
V_{ADCCM}	Analog input common mode voltage range		0		V_{DD}	V
V_{ADCIN}	Input voltage range of external reference voltage, single ended and differential		1.25		V_{DD}	V
I_{ADC}	Average active current	1 MSamples/s, 12 bit, external reference		220		μA
		10 kSamples/s 12 bit, internal 1.25 V reference, WARMUP-MODE in ADCn_CTRL set to 0b00		9		μA
		10 kSamples/s 12 bit, internal 1.25 V reference, WARMUP-MODE in ADCn_CTRL set to 0b01		6		μA
		10 kSamples/s 12 bit, internal 1.25 V reference, WARMUP-MODE in ADCn_CTRL set to 0b10		74		μA
		10 kSamples/s 12 bit, internal 1.25 V reference, WARMUP-MODE in ADCn_CTRL set to 0b11		290		μA
		6 bit 10 kSamples/s, internal 1.25 V reference, WARMUP-MODE in ADCn_CTRL set to 0b01		4		μA
I_{ADCREf}	Current consumption of internal voltage reference	Internal voltage reference		70		μA
C_{ADCIN}	Input capacitance			2		pF
R_{ADCIN}	Input ON resistance		1			MOhm
$V_{ADCCMOUT}$	Common mode output voltage range			1.65		V
f_{ADCCLK}	Frequency of ADC clock, max and min			13		MHz
$t_{ADCCONV}$	Conversion time			1		μs
t_{ADCACQ}	Acquisition time	Programmable		0.5		μs
$t_{ADCACQVDD3}$	Required sample time for VDD/3 reference			2		μs
$t_{ADCSTART}$	Startup time of reference generator in NORMAL mode and startup time ADC			5		μs
	Startup time of reference generator in KEEPAD-CWARM mode and startup time ADC			1		μs

Symbol	Parameter	Condition	Min	Typ	Max	Unit
SNR _{ADC}	Signal to Noise Ratio (SNR)	1 MSamples/s, 12 bit, single ended, internal 1.25V reference		69		dB
		1 MSamples/s, 12 bit, single ended, internal 2.5V reference		72		dB
		1 MSamples/s, 12 bit, differential, internal 1.25V reference		70		dB
		1 MSamples/s, 12 bit, differential, internal 2.5V reference		73		dB
		1 MSamples/s, 12 bit, differential, 5V reference		73		dB
		100 kSamples/s, 12 bit, single ended, internal 1.25V reference		69		dB
		100 kSamples/s, 12 bit, single ended, internal 2.5V reference		72		dB
		100 kSamples/s, 12 bit, differential, internal 1.25V reference		70		dB
		100 kSamples/s, 12 bit, differential, internal 2.5V reference		73		dB
		100 kSamples/s, 12 bit, differential, 5V reference		73		dB
		1.86 MSamples/s, 6 bit, single ended, internal 1.25V reference		37		dB
		SNDR _{ADC}	Signal to Noise-puls-Distortion Ratio (SNDR)	1 MSamples/s, 12 bit, single ended, internal 1.25V reference		68
1 MSamples/s, 12 bit, single ended, internal 2.5V reference				71		dB
1 MSamples/s, 12 bit, differential, internal 1.25V reference				69		dB
1 MSamples/s, 12 bit, differential, internal 2.5V reference				72		dB
1 MSamples/s, 12 bit, differential, 5V reference				72		dB
100 kSamples/s, 12 bit, single ended, internal 1.25V reference				68		dB
100 kSamples/s, 12 bit, single ended, internal 2.5V reference				71		dB
100 kSamples/s, 12 bit, differential, internal 1.25V reference				69		dB

Symbol	Parameter	Condition	Min	Typ	Max	Unit
		100 kSamples/s, 12 bit, differential, internal 2.5V reference		72		dB
		100 kSamples/s, 12 bit, differential, 5V reference		72		dB
		1.86 MSamples/s, 6 bit, single ended, internal 1.25V reference		37		dB
SFDR _{ADC}	Spurious-Free Dynamic Range (SFDR)	1 MSamples/s, 12 bit, single ended, internal 1.25V reference		75		dB
		1 MSamples/s, 12 bit, single ended, internal 2.5V reference		75		dB
		1 MSamples/s, 12 bit, differential, internal 1.25V reference		75		dB
		1 MSamples/s, 12 bit, differential, internal 2.5V reference		75		dB
		1 MSamples/s, 12 bit, differential, 5V reference		75		dB
		100 kSamples/s, 12 bit, single ended, internal 1.25V reference		75		dB
		100 kSamples/s, 12 bit, single ended, internal 2.5V reference		75		dB
		100 kSamples/s, 12 bit, differential, internal 1.25V reference		75		dB
		100 kSamples/s, 12 bit, differential, internal 2.5V reference		75		dB
		100 kSamples/s, 12 bit, differential, 5V reference		75		dB
V _{ADCOFFSET}	Offset voltage	Before calibration, single ended		10		mV
		After calibration, single ended		0.3		mV
		Before calibration, differential		10		mV
		After calibration, differential		0.3		mV
TGRAD _{ADCTH}	Thermometer output gradient			-1.85		mV/°C
				-6.1		ADC Codes/°C
DNL _{ADC}	Differential non-linearity (DNL)	Internal 1.25V reference		1		LSB
		Internal 2.5V reference		1		LSB
		Internal 5V reference		1		LSB

Symbol	Parameter	Condition	Min	Typ	Max	Unit
INL _{ADC}	Integral non-linearity (INL), End point method	Internal 1.25V reference		2		LSB
		Internal 2.5V reference		2		LSB
		Internal 5V reference		2		LSB
MC _{ADC}	No missing codes	12 bit, internal 1.25V reference, single ended		0		
		12 bit, internal 1.25V reference, differential		0		
		12 bit, internal 2.5V reference, single ended		0		
		12 bit, internal 2.5V reference, differential		0		
		12 bit, internal 5V reference, differential		0		

The integral non-linearity (INL) and differential non-linearity parameters are explained in Figure 3.51 (p. 31) and Figure 3.52 (p. 32) , respectively.

Figure 3.51. Integral Non-Linearity (INL)

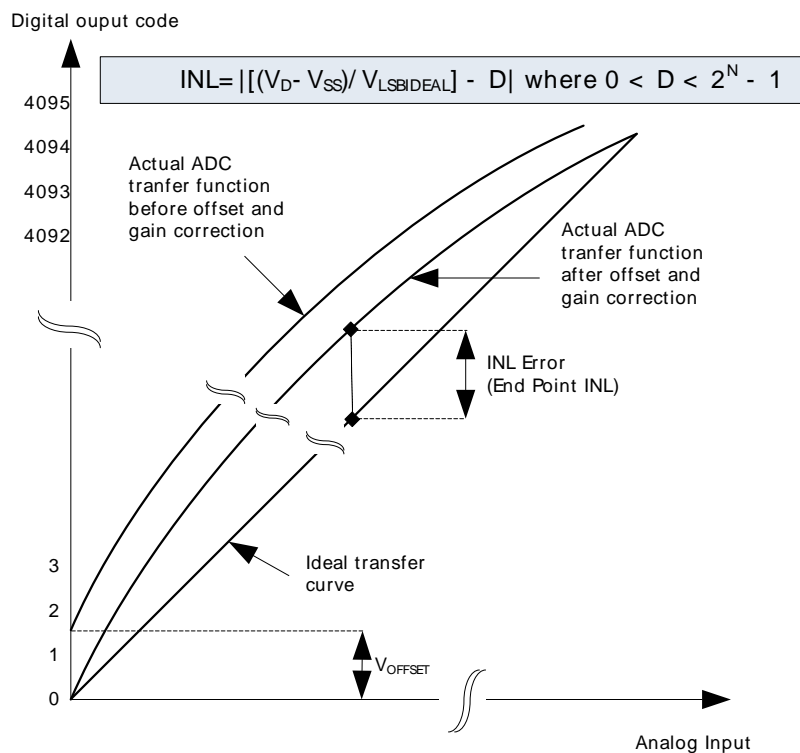
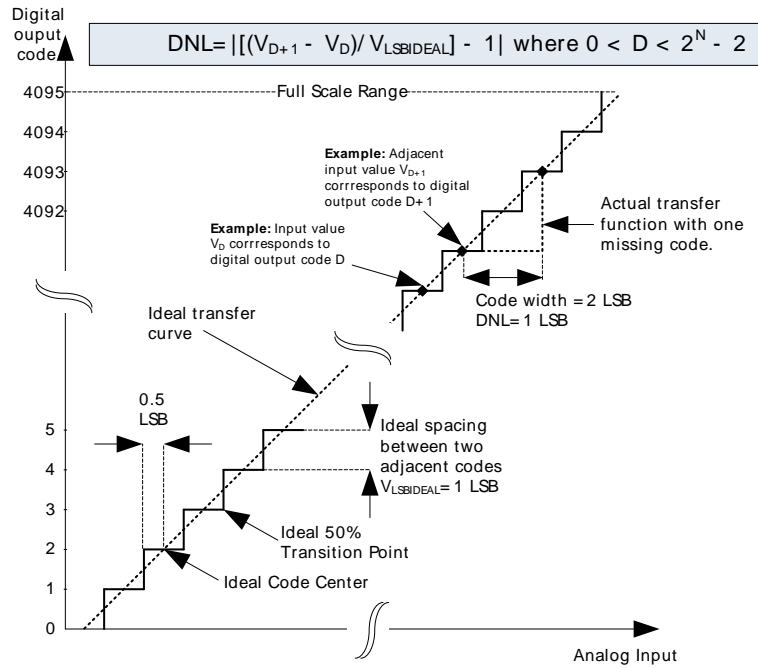

Figure 3.52. Differential Non-Linearity (DNL)



3.11 Digital Analog Converter (DAC)

Table 3.15. DAC

Symbol	Parameter	Condition	Min	Typ	Max	Unit
V_{DACOUT}	Output voltage range	External voltage reference, single ended	0		V_{DD}	V
		External voltage reference, differential	0		V_{DD}	V
V_{DACCM}	Output common mode voltage range		0		V_{DD}	V
I_{DAC}	Active current including references for 2 channels	500 kSamples/s, 12bit		400		μA
		100 kSamples/s, 12 bit		200		μA
		1 kSamples/s 12 bit NORMAL		38		μA
SR_{DAC}	DAC sample rate			500		ksamples/s
f_{DAC}	DAC clock frequency			1		MHz
$CYC_{DACCONV}$	Clock cycles per conversion			2		
$t_{DACCONV}$	DAC conversion time			2		μs
$t_{DACSETTLE}$	DAC settling time			5		μs
SNR_{DAC}	DAC Signal to Noise Ratio (SNR)	500 kSamples/s, 12 bit, single ended, internal 1.25V reference		71		dB
		500 kSamples/s, 12 bit, single ended, internal 2.5V reference		70		dB
		500 kSamples/s, 12 bit, differential, internal 1.25V reference		73		dB

Symbol	Parameter	Condition	Min	Typ	Max	Unit
		500 kSamples/s, 12 bit, differential, internal 2.5V reference		72		dB
		500 kSamples/s, 12 bit, differential, 5V reference		72		dB
		100 kSamples/s, 12 bit, single ended, internal 1.25V reference		72		dB
		100 kSamples/s, 12 bit, single ended, internal 2.5V reference		71		dB
		100 kSamples/s, 12 bit, differential, internal 1.25V reference		73		dB
		100 kSamples/s, 12 bit, differential, internal 2.5V reference		73		dB
		100 kSamples/s, 12 bit, differential, 5V reference		73		dB
SNDR _{DAC}	DAC Signal to Noise-pulse Distortion Ratio (SNDR)	500 kSamples/s, 12 bit, single ended, internal 1.25V reference		70		dB
		500 kSamples/s, 12 bit, single ended, internal 2.5V reference		69		dB
		500 kSamples/s, 12 bit, differential, internal 1.25V reference		72		dB
		500 kSamples/s, 12 bit, differential, internal 2.5V reference		71		dB
		500 kSamples/s, 12 bit, differential, 5V reference		71		dB
		100 kSamples/s, 12 bit, single ended, internal 1.25V reference		71		dB
		100 kSamples/s, 12 bit, single ended, internal 2.5V reference		70		dB
		100 kSamples/s, 12 bit, differential, internal 1.25V reference		72		dB
		100 kSamples/s, 12 bit, differential, internal 2.5V reference		72		dB
100 kSamples/s, 12 bit, differential, 5V reference		72		dB		
SFDR _{DAC}	DAC Spurious-Free Dynamic Range(SFDR)	500 kSamples/s, 12 bit, single ended, internal 1.25V reference		75		dB
		500 kSamples/s, 12 bit, single ended, internal 2.5V reference		75		dB

Symbol	Parameter	Condition	Min	Typ	Max	Unit
		500 kSamples/s, 12 bit, differential, internal 1.25V reference		75		dB
		500 kSamples/s, 12 bit, differential, internal 2.5V reference		75		dB
		500 kSamples/s, 12 bit, differential, 5V reference		75		dB
		100 kSamples/s, 12 bit, single ended, internal 1.25V reference		75		dB
		100 kSamples/s, 12 bit, single ended, internal 2.5V reference		75		dB
		100 kSamples/s, 12 bit, differential, internal 1.25V reference		75		dB
		100 kSamples/s, 12 bit, differential, internal 2.5V reference		75		dB
		100 kSamples/s, 12 bit, differential, 5V reference		75		dB
V _{DACOFFSET}	Offset voltage	Before calibration, single ended		10		mV
		Before calibration, differential		10		mV
		After calibration, single ended		0.5		mV
		After calibration, differential		0.5		mV
DNL _{DAC}	Differential non-linearity	Internal 1.25V reference		1		LSB
		Internal 2.5V reference		1		LSB
		5V reference		1		LSB
INL _{DAC}	Integral non-linearity	Internal 1.25V reference		2		LSB
		Internal 2.5V reference		2		LSB
		5V reference		2		LSB
MC _{DAC}	No missing codes	12 bit, internal 1.25V reference, single ended		0		
		12 bit, internal 1.25V reference, differential		0		
		12 bit, internal 2.5V reference, single ended		0		
		12 bit, internal 2.5V reference, differential		0		
		12 bit, internal 5V reference, differential		0		

3.12 Operational Amplifier (OPAMP)

Table 3.16. OPAMP

Symbol	Parameter	Condition	Min	Typ	Max	Unit
I _{OPAMP}	Active Current	Lowest Bias Setting		20		μA
		Highest Bias Setting		500		μA
G _{OL}	Open Loop Gain			100		dB
GBW _{OPAMP}	Gain Bandwidth Product			2.2		MHz
R _{LOAD}	Load Resistance			200		Ohm
CMRR _{OPAMP}	Common Mode Rejection Ratio			TBD		dB
PSRR _{OPAMP}	Power Supply Rejection Ratio			TBD		dB

3.13 Analog Comparators (ACMP)

Table 3.17. ACMP

Symbol	Parameter	Condition	Min	Typ	Max	Unit
V _{ACMPIN}	Input voltage range		0		V _{DD}	V
V _{ACMPCM}	ACMP Common Mode voltage range		0		V _{DD}	V
I _{ACMP}	Active current	BIASPROG=0b0000, FULL-BIAS=0 and HALFBIAS=1 in ACMPn_CTRL register		0.1		μA
		BIASPROG=0b1111, FULL-BIAS=0 and HALFBIAS=0 in ACMPn_CTRL register		2.87		μA
		BIASPROG=0b1111, FULL-BIAS=1 and HALFBIAS=0 in ACMPn_CTRL register		195		μA
I _{ACMPREF}	Current consumption of internal voltage reference	Internal voltage reference off. Using external voltage reference		0		μA
		Internal voltage reference		5		μA
V _{ACMPOFFSET}	Offset voltage	Single ended		10		mV
		Differential		10		mV
V _{ACMPHYST}	ACMP hysteresis	Programmable		17		mV
R _{CSRES}	Capacitive Sense Internal Resistance	CSRESSEL=0b00 in ACMPn_INPUTSEL		39		kOhm
		CSRESSEL=0b01 in ACMPn_INPUTSEL		71		kOhm
		CSRESSEL=0b10 in ACMPn_INPUTSEL		104		kOhm
		CSRESSEL=0b11 in ACMPn_INPUTSEL		136		kOhm

The total ACMP current is the sum of the contributions from the ACMP and its internal voltage reference as given in Equation 3.1 (p. 36) . $I_{ACMPREF}$ is zero if an external voltage reference is used.

Total ACMP Active Current

$$I_{ACMPTOTAL} = I_{ACMP} + I_{ACMPREF} \tag{3.1}$$

3.14 Voltage Comparator (VCMP)

Table 3.18. VCMP

Symbol	Parameter	Condition	Min	Typ	Max	Unit
V _{VCMPIN}	Input voltage range			V _{DD}		V
V _{VCMP_{CM}}	VCMP Common Mode voltage range			V _{DD}		V
I _{VCMP}	Active current	BIASPROG=0b0000 and HALFBIAS=1 in VCMPn_CTRL register		0.1		μA
		BIASPROG=0b1111 and HALFBIAS=0 in VCMPn_CTRL register		2.7		μA
t _{VCMPREF}	Startup time reference generator	NORMAL		10		μs
V _{VCMP_{OFFSET}}	Offset voltage	Single ended		10		mV
		Differential		10		mV
V _{VCMP_{HYST}}	VCMP hysteresis			17		mV

The V_{DD} trigger level can be configured by setting the TRIGLEVEL field of the VCMP_CTRL register in accordance with the following equation:

VCMP Trigger Level as a Function of Level Setting

$$V_{DD \text{ Trigger Level}} = 1.667V + 0.034 \times \text{TRIGLEVEL} \tag{3.2}$$

3.15 LCD

Table 3.19. LCD

Symbol	Parameter	Condition	Min	Typ	Max	Unit
f _{LCDFR}	Frame rate		30		200	Hz
NUM _{SEG}	Number of segments supported			4x40		seg
V _{LCD}	LCD supply voltage range	Internal boost circuit enabled	2.0		3.8	V
I _{LCD}	Steady state current consumption.	Display disconnected, static mode, framerate 32 Hz, all segments on.		250		nA
		Display disconnected, quadruplex mode, framerate 32 Hz, all segments on, bias mode to ONETHIRD in LCD_DISPCTRL register.		550		nA
I _{LCDBOOST}	Steady state Current contribution of internal boost.	Internal voltage boost off		0		μA
		Internal voltage boost on, boosting from 2.2 V to 3.0 V.		8.4		μA
V _{BOOST}	Boost Voltage	VBLEV of LCD_DISPCTRL register to LEVEL0		3.0		V
		VBLEV of LCD_DISPCTRL register to LEVEL1		3.08		V
		VBLEV of LCD_DISPCTRL register to LEVEL2		3.17		V
		VBLEV of LCD_DISPCTRL register to LEVEL3		3.26		V
		VBLEV of LCD_DISPCTRL register to LEVEL4		3.34		V
		VBLEV of LCD_DISPCTRL register to LEVEL5		3.43		V
		VBLEV of LCD_DISPCTRL register to LEVEL6		3.52		V
		VBLEV of LCD_DISPCTRL register to LEVEL7		3.6		V

The total LCD current is given by Equation 3.3 (p. 37) . I_{LCDBOOST} is zero if internal boost is off.

Total LCD Current Based on Operational Mode and Internal Boost

$$I_{LCDTOTAL} = I_{LCD} + I_{LCDBOOST} \tag{3.3}$$

3.16 Digital Peripherals

Table 3.20. Digital Peripherals

Symbol	Parameter	Condition	Min	Typ	Max	Unit
I _{USART}	USART current	USART idle current, clock enabled		7.5		μA/MHz
I _{UART}	UART current	UART idle current, clock enabled		5.63		μA/MHz

Symbol	Parameter	Condition	Min	Typ	Max	Unit
I _{LEUART}	LEUART current	LEUART idle current, clock enabled		150		nA
I _{I2C}	I2C current	I2C idle current, clock enabled		6.25		μA/ MHz
I _{TIMER}	TIMER current	TIMER_0 idle current, clock enabled		8.75		μA/ MHz
I _{LETIMER}	LETIMER current	LETIMER idle current, clock enabled		150		nA
I _{PCNT}	PCNT current	PCNT idle current, clock enabled		100		nA
I _{RTC}	RTC current	RTC idle current, clock enabled		100		nA
I _{LCD}	LCD current	LCD idle current, clock enabled		100		nA
I _{AES}	AES current	AES idle current, clock enabled		2.5		μA/ MHz
I _{GPIO}	GPIO current	GPIO idle current, clock enabled		5.31		μA/ MHz
I _{PRS}	PRS current	PRS idle current		2,81		μA/ MHz
I _{DMA}	DMA current	Clock enable		8.12		μA/ MHz

4 Pinout and Package

Note

Please refer to the application note "AN0002 EFM32G Hardware Design Considerations" for guidelines on designing Printed Circuit Boards (PCBs) for the EFM32TG840.

4.1 Pinout

The EFM32TG840 pinout is shown in Figure 4.1 (p. 39) and Table 4.1 (p. 39). Alternate locations are denoted by "#" followed by the location number (Multiple locations on the same pin are split with "/"). Alternate locations can be configured in the LOCATION bitfield in the *_ROUTE register in the module in question.

The OPAMP0 pins will be included in a later revision of this datasheet.

Figure 4.1. EFM32TG840 Pinout (top view, not to scale)

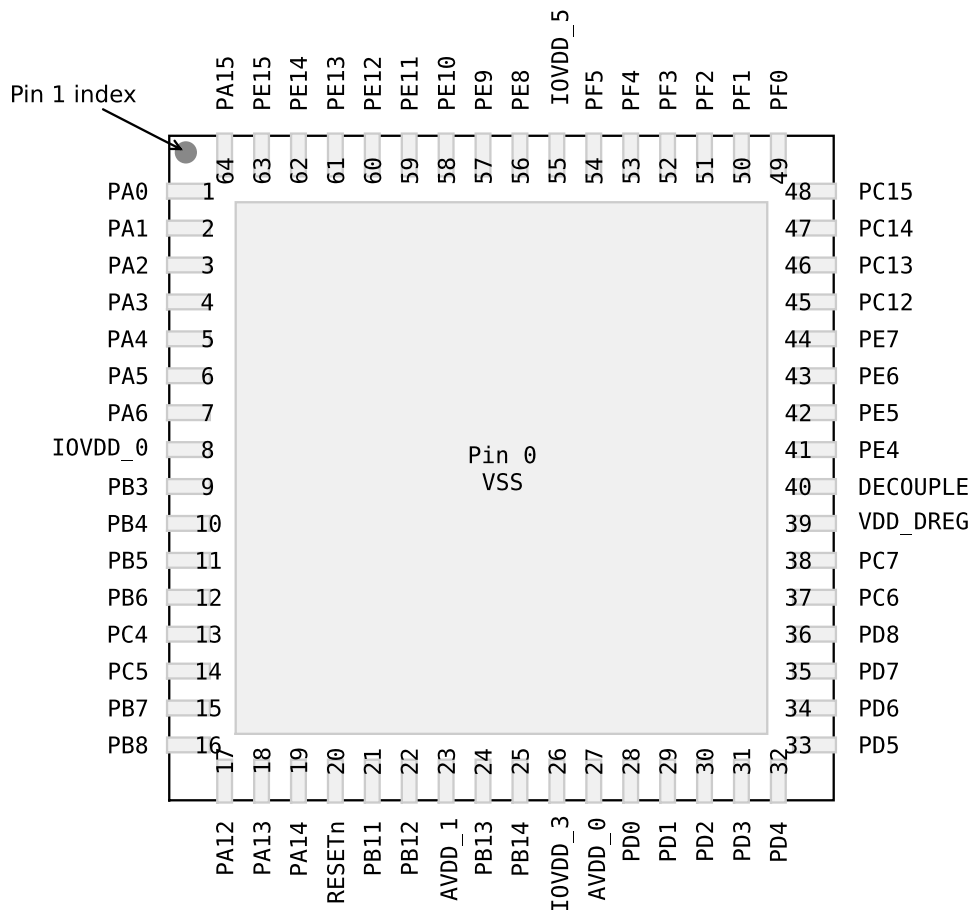

Table 4.1. Device Pinout

QFN64 Pin# and Name		Pin Alternate Functionality / Description								
Pin #	Pin Name	Analog	Debug	EBI	Timers			Communication	Other	
0	VSS	Ground								
1	PA0	LCD_SEG13	-	-	TIM0_CC0 #0/1	-	-	I2C0_SDA #0	-	-

QFN64 Pin# and Name		Pin Alternate Functionality / Description								
Pin #	Pin Name	Analog	Debug	EBI	Timers			Communication		Other
2	PA1	LCD_SEG14	-	-	TIM0_CC1 #0/1	-	-	I2C0_SCL #0	-	CMU_OUT1 #0
3	PA2	LCD_SEG15	-	-	TIM0_CC2 #0/1	-	-	-	-	CMU_OUT0 #0
4	PA3	LCD_SEG16	-	-	TIM0_CDT10 #0	-	-	U0_TX #2	-	-
5	PA4	LCD_SEG17	-	-	TIM0_CDT11 #0	-	-	U0_RX #2	-	-
6	PA5	LCD_SEG18	-	-	TIM0_CDT12 #0	-	-	-	-	-
7	PA6	LCD_SEG19	-	-	-	-	-	-	-	-
8	IOVDD_0	Digital IO power supply 0.								
9	PB3	LCD_SEG20	-	-	-	-	-	-	-	-
10	PB4	LCD_SEG21	-	-	-	-	-	-	-	-
11	PB5	LCD_SEG22	-	-	-	-	-	-	-	-
12	PB6	LCD_SEG23	-	-	-	-	-	-	-	-
13	PC4	ACMP0_CH4	-	-	LETIM0_OUT0 #3	-	-	-	-	-
14	PC5	ACMP0_CH5	-	-	LETIM0_OUT1 #3	-	-	-	-	-
15	PB7	LFXTAL_P	-	-	-	-	-	-	-	-
16	PB8	LFXTAL_N	-	-	-	-	-	-	-	-
17	PA12	LCD_BCAP_P	-	-	-	-	-	-	-	-
18	PA13	LCD_BCAP_N	-	-	-	-	-	-	-	-
19	PA14	LCD_BEXT	-	-	-	-	-	-	-	-
20	RESETn	Reset input. Active low, with internal pull-up.								
21	PB11	DAC0_OUT0	-	-	LETIM0_OUT0 #1	-	-	-	-	-
22	PB12	DAC0_OUT1	-	-	LETIM0_OUT1 #1	-	-	-	-	-
23	AVDD_1	Analog power supply 1 .								
24	PB13	HFXTAL_P	-	-	-	-	-	LEU0_TX #1	-	-
25	PB14	HFXTAL_N	-	-	-	-	-	LEU0_RX #1	-	-
26	IOVDD_3	Digital IO power supply 3.								
27	AVDD_0	Analog power supply 0.								
28	PD0	ADC0_CH0	-	-	-	-	-	-	-	-
29	PD1	ADC0_CH1	-	-	TIM0_CC0 #3	-	-	-	-	-
30	PD2	ADC0_CH2	-	-	TIM0_CC1 #3	-	-	-	-	-
31	PD3	ADC0_CH3	-	-	TIM0_CC2 #3	-	-	-	-	-
32	PD4	ADC0_CH4	-	-	-	-	-	LEU0_TX #0	-	-

QFN64 Pin# and Name		Pin Alternate Functionality / Description								
Pin #	Pin Name	Analog	Debug	EBI	Timers			Communication		Other
33	PD5	ADC0_CH5	-	-	-	-	-	LEU0_RX #0	-	-
34	PD6	ADC0_CH6	-	-	LETIM0_OUT0 #0	-	-	I2C0_SDA #1	-	-
35	PD7	ADC0_CH7	-	-	LETIM0_OUT1 #0	-	-	I2C0_SCL #1	-	-
36	PD8	-	-	-	-	-	-	-	-	CMU_OUT1 #1
37	PC6	ACMP0_CH6	-	-	-	-	-	I2C0_SDA #2	-	-
38	PC7	ACMP0_CH7	-	-	-	-	-	I2C0_SCL #2	-	-
39	VDD_DREG	Power supply for on-chip voltage regulator.								
40	DECOUPLE	Decouple output for on-chip voltage regulator, nominally at 1.8 V. An external capacitance of size C _{DECOUPLE} is required at this pin.								
41	PE4	LCD_COM0	-	-	-	-	-	US0_CS #1	-	-
42	PE5	LCD_COM1	-	-	-	-	-	US0_CLK #1	-	-
43	PE6	LCD_COM2	-	-	-	-	-	US0_RX #1	-	-
44	PE7	LCD_COM3	-	-	-	-	-	US0_TX #1	-	-
45	PC12	ACMP1_CH4	-	-	-	-	-	-	-	CMU_OUT0 #1
46	PC13	ACMP1_CH5	-	-	TIM0_CDTI0 #1/3	TIM1_CC0 #0	PCNT0_S0IN #0	-	-	-
47	PC14	ACMP1_CH6	-	-	TIM0_CDTI1 #1/3	TIM1_CC1 #0	PCNT0_S1IN #0	U0_TX #3	-	-
48	PC15	ACMP1_CH7	DBG_SWO #1	-	TIM0_CDTI2 #1/3	TIM1_CC2 #0	-	U0_RX #3	-	-
49	PF0	-	DBG_SWCLK #0/1	-	LETIM0_OUT0 #2	-	-	-	-	-
50	PF1	-	DBG_SWDIO #0/1	-	LETIM0_OUT1 #2	-	-	-	-	-
51	PF2	LCD_SEG0	DBG_SWO #0	-	-	-	-	-	-	ACMP1_O #0
52	PF3	LCD_SEG1	-	-	TIM0_CDTI0 #2	-	-	-	-	-
53	PF4	LCD_SEG2	-	-	TIM0_CDTI1 #2	-	-	-	-	-
54	PF5	LCD_SEG3	-	-	TIM0_CDTI2 #2	-	-	-	-	-
55	IOVDD_5	Digital IO power supply 5.								
56	PE8	LCD_SEG4	-	-	-	-	-	-	-	-
57	PE9	LCD_SEG5	-	-	-	-	-	-	-	-
58	PE10	LCD_SEG6	-	-	TIM1_CC0 #1	-	-	US0_TX #0	-	-
59	PE11	LCD_SEG7	-	-	TIM1_CC1 #1	-	-	US0_RX #0	-	-
60	PE12	LCD_SEG8	-	-	TIM1_CC2 #1	-	-	US0_CLK #0	-	-

QFN64 Pin# and Name		Pin Alternate Functionality / Description								
Pin #	Pin Name	Analog	Debug	EBI	Timers			Communication		Other
61	PE13	LCD_SEG9	-	-	-	-	-	US0_CS #0	-	ACMP0_O #0
62	PE14	LCD_SEG10	-	-	-	-	-	LEU0_TX #2	-	-
63	PE15	LCD_SEG11	-	-	-	-	-	LEU0_RX #2	-	-
64	PA15	LCD_SEG12	-	-	-	-	-	-	-	-

4.2 Alternate functionality pinout

A wide selection of alternate functionality is available for multiplexing to various pins. This is shown in Table 4.2 (p. 42). The table shows the name of the alternate functionality in the first column, followed by columns showing the possible LOCATION bitfield settings.

Note

Some functionality, such as analog interfaces, do not have alternate settings or a LOCATION bitfield. In these cases, the pinout is shown in the column corresponding to LOCATION 0.

Table 4.2. Alternate functionality overview

Alternate Functionality	LOCATION				Description
	0	1	2	3	
ACMP0_CH4	PC4				Analog comparator ACMP0, channel 4.
ACMP0_CH5	PC5				Analog comparator ACMP0, channel 5.
ACMP0_CH6	PC6				Analog comparator ACMP0, channel 6.
ACMP0_CH7	PC7				Analog comparator ACMP0, channel 7.
ACMP0_O	PE13				Analog comparator ACMP0, digital output.
ACMP1_CH4	PC12				Analog comparator ACMP1, channel 4.
ACMP1_CH5	PC13				Analog comparator ACMP1, channel 5.
ACMP1_CH6	PC14				Analog comparator ACMP1, channel 6.
ACMP1_CH7	PC15				Analog comparator ACMP1, channel 7.
ACMP1_O	PF2				Analog comparator ACMP1, digital output.
ADC0_CH0	PD0				Analog to digital converter ADC0, input channel number 0.
ADC0_CH1	PD1				Analog to digital converter ADC0, input channel number 1.
ADC0_CH2	PD2				Analog to digital converter ADC0, input channel number 2.
ADC0_CH3	PD3				Analog to digital converter ADC0, input channel number 3.
ADC0_CH4	PD4				Analog to digital converter ADC0, input channel number 4.
ADC0_CH5	PD5				Analog to digital converter ADC0, input channel number 5.
ADC0_CH6	PD6				Analog to digital converter ADC0, input channel number 6.
ADC0_CH7	PD7				Analog to digital converter ADC0, input channel number 7.
CMU_OUT0	PA2	PC12			Clock Management Unit, clock output number 0.
CMU_OUT1	PA1	PD8			Clock Management Unit, clock output number 1.
DAC0_OUT0	PB11				Digital to Analog Converter DAC0 output channel number 0.
DAC0_OUT1	PB12				Digital to Analog Converter DAC0 output channel number 1.

Alternate	LOCATION				Description
	0	1	2	3	
DBG_SWCLK	PF0	PF0			Debug-interface Serial Wire clock input. Note that this function is enabled to pin out of reset, and has a built-in pull down.
DBG_SWDIO	PF1	PF1			Debug-interface Serial Wire data input / output. Note that this function is enabled to pin out of reset, and has a built-in pull up.
DBG_SWO	PF2	PC15			Debug-interface Serial Wire viewer Output. Note that this function is not enabled after reset, and must be enabled by software to be used.
HFX TAL_N	PB14				High Frequency Crystal (4 - 32 MHz) negative pin. Also used as external optional clock input pin.
HFX TAL_P	PB13				High Frequency Crystal (4 - 32 MHz) positive pin.
I2C0_SCL	PA1	PD7	PC7		I2C0 Serial Clock Line input / output.
I2C0_SDA	PA0	PD6	PC6		I2C0 Serial Data input / output.
LCD_BCAP_N	PA13				LCD voltage booster (optional), boost capacitor, negative pin. If using the LCD voltage booster, connect a 22 nF capacitor between LCD_BCAP_N and LCD_BCAP_P.
LCD_BCAP_P	PA12				LCD voltage booster (optional), boost capacitor, positive pin. If using the LCD voltage booster, connect a 22 nF capacitor between LCD_BCAP_N and LCD_BCAP_P.
LCD_BEXT	PA14				LCD voltage booster (optional), boost output. If using the LCD voltage booster, connect a 1 uF capacitor between this pin and VSS. An external LCD voltage may also be applied to this pin if the booster is not enabled. If AVDD is used directly as the LCD supply voltage, this pin may be left unconnected or used as a GPIO.
LCD_COM0	PE4				LCD driver common line number 0.
LCD_COM1	PE5				LCD driver common line number 1.
LCD_COM2	PE6				LCD driver common line number 2.
LCD_COM3	PE7				LCD driver common line number 3.
LCD_SEG0	PF2				LCD segment line 0. Segments 0, 1, 2 and 3 are controlled by SEGEN0.
LCD_SEG1	PF3				LCD segment line 1. Segments 0, 1, 2 and 3 are controlled by SEGEN0.
LCD_SEG2	PF4				LCD segment line 2. Segments 0, 1, 2 and 3 are controlled by SEGEN0.
LCD_SEG3	PF5				LCD segment line 3. Segments 0, 1, 2 and 3 are controlled by SEGEN0.
LCD_SEG4	PE8				LCD segment line 4. Segments 4, 5, 6 and 7 are controlled by SEGEN1.
LCD_SEG5	PE9				LCD segment line 5. Segments 4, 5, 6 and 7 are controlled by SEGEN1.
LCD_SEG6	PE10				LCD segment line 6. Segments 4, 5, 6 and 7 are controlled by SEGEN1.
LCD_SEG7	PE11				LCD segment line 7. Segments 4, 5, 6 and 7 are controlled by SEGEN1.
LCD_SEG8	PE12				LCD segment line 8. Segments 8, 9, 10 and 11 are controlled by SEGEN2.
LCD_SEG9	PE13				LCD segment line 9. Segments 8, 9, 10 and 11 are controlled by SEGEN2.
LCD_SEG10	PE14				LCD segment line 10. Segments 8, 9, 10 and 11 are controlled by SEGEN2.
LCD_SEG11	PE15				LCD segment line 11. Segments 8, 9, 10 and 11 are controlled by SEGEN2.
LCD_SEG12	PA15				LCD segment line 12. Segments 12, 13, 14 and 15 are controlled by SEGEN3.
LCD_SEG13	PA0				LCD segment line 13. Segments 12, 13, 14 and 15 are controlled by SEGEN3.
LCD_SEG14	PA1				LCD segment line 14. Segments 12, 13, 14 and 15 are controlled by SEGEN3.
LCD_SEG15	PA2				LCD segment line 15. Segments 12, 13, 14 and 15 are controlled by SEGEN3.
LCD_SEG16	PA3				LCD segment line 16. Segments 16, 17, 18 and 19 are controlled by SEGEN4.
LCD_SEG17	PA4				LCD segment line 17. Segments 16, 17, 18 and 19 are controlled by SEGEN4.

Alternate Functionality	LOCATION				Description
	0	1	2	3	
LCD_SEG18	PA5				LCD segment line 18. Segments 16, 17, 18 and 19 are controlled by SEGEN4.
LCD_SEG19	PA6				LCD segment line 19. Segments 16, 17, 18 and 19 are controlled by SEGEN4.
LCD_SEG20	PB3				LCD segment line 20. Segments 20, 21, 22 and 23 are controlled by SEGEN5.
LCD_SEG21	PB4				LCD segment line 21. Segments 20, 21, 22 and 23 are controlled by SEGEN5.
LCD_SEG22	PB5				LCD segment line 22. Segments 20, 21, 22 and 23 are controlled by SEGEN5.
LCD_SEG23	PB6				LCD segment line 23. Segments 20, 21, 22 and 23 are controlled by SEGEN5.
LETIM0_OUT0	PD6	PB11	PF0	PC4	Low Energy Timer LETIM0, output channel 0.
LETIM0_OUT1	PD7	PB12	PF1	PC5	Low Energy Timer LETIM0, output channel 1.
LEU0_RX	PD5	PB14	PE15		LEUART0 Receive input.
LEU0_TX	PD4	PB13	PE14		LEUART0 Transmit output. Also used as receive input in half duplex communication.
LFXTAL_N	PB8				Low Frequency Crystal (typically 32.768 kHz) negative pin. Also used as an optional external clock input pin.
LFXTAL_P	PB7				Low Frequency Crystal (typically 32.768 kHz) positive pin.
PCNT0_S0IN	PC13				Pulse Counter PCNT0 input number 0.
PCNT0_S1IN	PC14				Pulse Counter PCNT0 input number 1.
TIM0_CC0	PA0	PA0		PD1	Timer 0 Capture Compare input / output channel 0.
TIM0_CC1	PA1	PA1		PD2	Timer 0 Capture Compare input / output channel 1.
TIM0_CC2	PA2	PA2		PD3	Timer 0 Capture Compare input / output channel 2.
TIM0_CDTI0	PA3	PC13	PF3	PC13	Timer 0 Complimentary Deat Time Insertion channel 0.
TIM0_CDTI1	PA4	PC14	PF4	PC14	Timer 0 Complimentary Deat Time Insertion channel 1.
TIM0_CDTI2	PA5	PC15	PF5	PC15	Timer 0 Complimentary Deat Time Insertion channel 2.
TIM1_CC0	PC13	PE10			Timer 1 Capture Compare input / output channel 0.
TIM1_CC1	PC14	PE11			Timer 1 Capture Compare input / output channel 1.
TIM1_CC2	PC15	PE12			Timer 1 Capture Compare input / output channel 2.
U0_RX			PA4	PC15	UART0 Receive input.
U0_TX			PA3	PC14	UART0 Transmit output. Also used as receive input in half duplex communication.
US0_CLK	PE12	PE5			USART0 clock input / output.
US0_CS	PE13	PE4			USART0 chip select input / output.
US0_RX	PE11	PE6			USART0 Asynchronous Receive. USART0 Synchronous mode Master Input / Slave Output (MISO).
US0_TX	PE10	PE7			USART0 Asynchronous Transmit. Also used as receive input in half duplex communication. USART0 Synchronous mode Master Output / Slave Input (MOSI).

4.3 GPIO pinout overview

The specific GPIO pins available in *EFM32TG840* is shown in Table 4.3 (p. 45). Each GPIO port is organized as 16-bit ports indicated by letters A through F, and the individual pin on this port in indicated by a number from 15 down to 0.

Table 4.3. GPIO Pinout

Port	Pin 15	Pin 14	Pin 13	Pin 12	Pin 11	Pin 10	Pin 9	Pin 8	Pin 7	Pin 6	Pin 5	Pin 4	Pin 3	Pin 2	Pin 1	Pin 0
Port A	PA15	PA14	PA13	PA12	-	-	-	-	-	PA6	PA5	PA4	PA3	PA2	PA1	PA0
Port B	-	PB14	PB13	PB12	PB11	-	-	PB8	PB7	PB6	PB5	PB4	PB3	-	-	-
Port C	PC15	PC14	PC13	PC12	-	-	-	-	PC7	PC6	PC5	PC4	-	-	-	-
Port D	-	-	-	-	-	-	-	PD8	PD7	PD6	PD5	PD4	PD3	PD2	PD1	PD0
Port E	PE15	PE14	PE13	PE12	PE11	PE10	PE9	PE8	PE7	PE6	PE5	PE4	-	-	-	-
Port F	-	-	-	-	-	-	-	-	-	-	PF5	PF4	PF3	PF2	PF1	PF0

4.4 QFN64 Package

Figure 4.2. QFN64

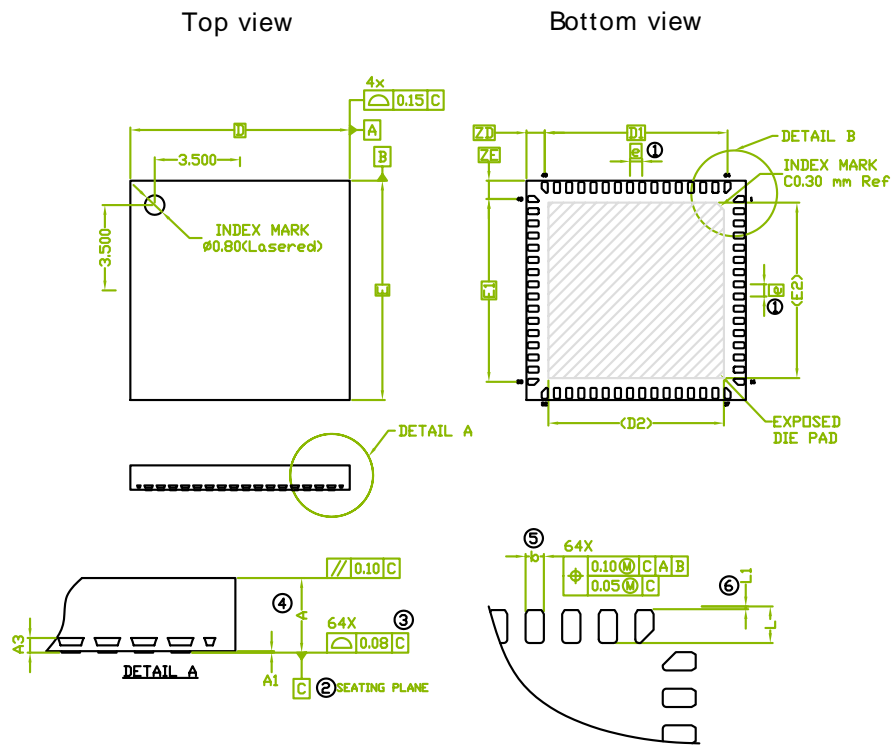

Note:

- 'e' represents the basic terminal pitch. Specifies the true geometric position of the terminal axis.
- Datum 'C' is the mounting surface with which the package is in contact
- Specifies the vertical shift of the flat part of each terminal from the mounting surface.
- Dimension 'A' includes package warpage.
- Dimension 'b' applies to metallized terminal and is measured between 0.15 mm and 0.30 mm from the terminal tip. If the terminal has the optional radius on the other end of the terminal, the dimension 'b' should not be measured in the radius area.
- Depending on the method of lead termination at the edge of the package, a maximum 0.15 mm pull back (L1) may be present. 'L' minus 'L1' is to be equal to or greater than 0.3 mm.
- Package dimensions take reference from JEDEC MO-220 rev. K, variations VJJ-2, except D2 and E2.

Table 4.4. QFN64 (Dimensions in mm)

Symbol	A	A1	A3	D	D1	E	E1	e	L1	ZD	ZE	b	L	D2	E2
Min	-	0.00							0.03			0.18	0.45	7.10	7.10
Nom	0.80	0.02	0.20	9.00	7.50	9.00	7.50	0.50	-	0.75	0.75	0.25	0.50	7.20	7.20
Max	0.90	0.05							0.15			0.30	0.55	7.30	7.30

5 Chip Marking, Revision and Errata

5.1 Chip Marking

In the illustration below package fields and position are shown.

Figure 5.1. QFN64 Chip Marking

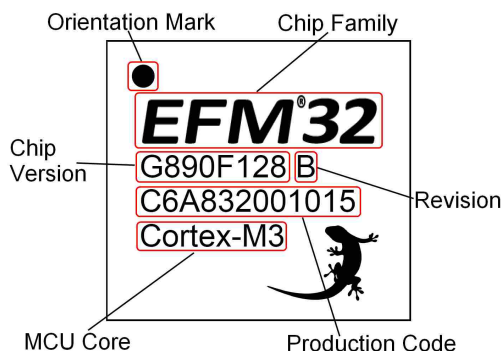

5.2 Revision

The revision of a chip can be determined from the "Revision" field in Figure 5.1 (p. 47). If the revision says "ES" (Engineering Sample), the revision must be read out electronically as specified in the reference manual.

5.3 Errata

No known errata currently exists for the EFM32TG840.

6 Revision History

6.1 Revision 0.50

May 25th, 2010

Block diagram update.

6.2 Revision 0.40

March 26th, 2010

Initial preliminary release.

A Disclaimer and Trademarks

A.1 Disclaimer

Energy Micro AS intends to provide customers with the latest, accurate, and in-depth documentation of all peripherals and modules available for system and software implementers using or intending to use the EFM32G microcontrollers. Characterization data, available modules and peripherals, memory sizes and memory addresses refer to each specific device, and “Typical” parameters provided can and do vary in different applications. Application examples described herein are for illustrative purposes only, and Energy Micro accepts no liability for inclusion and/or use in such equipment or applications resulting in personal injury, death or severe property or environmental damage. Energy Micro reserves the right to make changes without further notice and limitation to product information, specifications, and descriptions herein, and does not give warranties as to the accuracy or completeness of the included information. Energy Micro shall have no liability for the consequences of use of the information supplied herein. This document does not imply or express copyright licenses granted hereunder to design or fabricate any integrated circuits.

A.2 Trademark Information

Energy Micro, EFM32G, logo and combinations thereof, and others are the registered trademarks or trademarks of Energy Micro AS. ARM, CORTEX, THUMB are the registered trademarks of ARM Limited. Other terms and product names may be trademarks of others.

B Contact Information

B.1 Energy Micro Corporate Headquarters

Postal Address	Visitor Address	Technical Support
Energy Micro AS P.O. Box 4633 Nydalen N-0405 Oslo NORWAY	Energy Micro AS Sandakerveien 118 N-0405 Oslo NORWAY	support.energymicro.com Phone: +47 40 10 03 01

www.energymicro.com

Phone: +47 23 00 98 00

Fax: + 47 23 00 98 01

B.2 Global Contacts

Visit **www.energymicro.com** for information on global distributors and representatives or contact **sales@energymicro.com** for additional information.

Americas	Europe, Middle East and Africa	Asia and Pacific
www.energymicro.com/americas	www.energymicro.com/emea	www.energymicro.com/asia

Table of Contents

1. Ordering Information	2
1.1. Block Diagram	2
2. System Summary	3
2.1. System Introduction	3
2.2. Configuration Summary	6
2.3. Memory Map	7
3. Electrical Characteristics	8
3.1. Test Conditions	8
3.2. Absolute Maximum Ratings	8
3.3. General Operating Conditions	8
3.4. Current Consumption	10
3.5. Transition between Energy Modes	17
3.6. Power Management	18
3.7. Flash	18
3.8. General Purpose Input Output	19
3.9. Oscillators	26
3.10. Analog Digital Converter (ADC)	28
3.11. Digital Analog Converter (DAC)	32
3.12. Operational Amplifier (OPAMP)	35
3.13. Analog Comparator (ACMP)	35
3.14. Voltage Comparator (VCMP)	36
3.15. LCD	37
3.16. Digital Peripherals	37
4. Pinout and Package	39
4.1. Pinout	39
4.2. Alternate functionality pinout	42
4.3. GPIO pinout overview	44
4.4. QFN64 Package	45
5. Chip Marking, Revision and Errata	47
5.1. Chip Marking	47
5.2. Revision	47
5.3. Errata	47
6. Revision History	48
6.1. Revision 0.50	48
6.2. Revision 0.40	48
A. Disclaimer and Trademarks	49
A.1. Disclaimer	49
A.2. Trademark Information	49
B. Contact Information	50
B.1. Energy Micro Corporate Headquarters	50
B.2. Global Contacts	50

List of Figures

- 1.1. Block Diagram 2
- 2.1. EFM32TG840 Memory Map with largest RAM and Flash sizes 7
- 3.1. EM0 Current consumption vs supply voltage, executing prime number calculation code from flash with HFRCO running at 28MHz 11
- 3.2. EM0 Current consumption vs temperature, executing prime number calculation code from flash with HFRCO running at 28MHz 11
- 3.3. EM0 Current consumption vs supply voltage, executing prime number calculation code from flash with HFRCO running at 21MHz 11
- 3.4. EM0 Current consumption vs temperature, executing prime number calculation code from flash with HFRCO running at 21MHz 11
- 3.5. EM0 Current consumption vs supply voltage, executing prime number calculation code from flash with HFRCO running at 14MHz 12
- 3.6. EM0 Current consumption vs temperature, executing prime number calculation code from flash with HFRCO running at 14MHz 12
- 3.7. EM0 Current consumption vs supply voltage, executing prime number calculation code from flash with HFRCO running at 11MHz 12
- 3.8. EM0 Current consumption vs temperature, executing prime number calculation code from flash with HFRCO running at 11MHz 12
- 3.9. EM0 Current consumption vs supply voltage, executing prime number calculation code from flash with HFRCO running at 7MHz 13
- 3.10. EM0 Current consumption vs temperature, executing prime number calculation code from flash with HFRCO running at 7MHz 13
- 3.11. EM1 Current consumption vs supply voltage, all peripheral clocks disabled, HFRCO running at 28MHz 13
- 3.12. EM1 Current consumption vs temperature, all peripheral clocks disabled, HFRCO running at 28MHz 13
- 3.13. EM1 Current consumption vs supply voltage, all peripheral clocks disabled, HFRCO running at 21MHz 14
- 3.14. EM1 Current consumption vs temperature, all peripheral clocks disabled, HFRCO running at 21MHz 14
- 3.15. EM1 Current consumption vs supply voltage, all peripheral clocks disabled, HFRCO running at 14MHz 14
- 3.16. EM1 Current consumption vs temperature, all peripheral clocks disabled, HFRCO running at 14MHz 14
- 3.17. EM1 Current consumption vs supply voltage, all peripheral clocks disabled, HFRCO running at 11MHz 15
- 3.18. EM1 Current consumption vs temperature, all peripheral clocks disabled, HFRCO running at 11MHz 15
- 3.19. EM1 Current consumption vs supply voltage, all peripheral clocks disabled, HFRCO running at 7MHz 15
- 3.20. EM1 Current consumption vs temperature, all peripheral clocks disabled, HFRCO running at 7MHz 15
- 3.21. EM2 Current consumption vs supply voltage. RTC incremented each second, RTC prescaled to 1kHz, 32 kHz LFRCO. 16
- 3.22. EM2 Current consumption vs temperature. RTC incremented each second, RTC prescaled to 1kHz, 32 kHz LFRCO. 16
- 3.23. EM3 Current consumption vs supply voltage 16
- 3.24. EM3 Current consumption vs temperature 16
- 3.25. EM4 Current consumption vs supply voltage 17
- 3.26. EM4 Current consumption vs temperature 17
- 3.27. Port output current, 0.5 mA Drive Strength 20
- 3.28. Port output current, 2 mA Drive Strength 20
- 3.29. Port output current, 6 mA Drive Strength 20
- 3.30. Port output current, 20 mA Drive Strength 20
- 3.31. Port output current, 0.5 mA Drive Strength 21
- 3.32. Port output current, 2 mA Drive Strength 21
- 3.33. Port output current, 6 mA Drive Strength 21
- 3.34. Port output current, 20 mA Drive Strength 21
- 3.35. Port output current, 0.5 mA Drive Strength 22
- 3.36. Port output current, 2 mA Drive Strength 22
- 3.37. Port output current, 6 mA Drive Strength 22
- 3.38. Port output current, 20 mA Drive Strength 22
- 3.39. Port output current, 0.5 mA Drive Strength 23
- 3.40. Port output current, 2 mA Drive Strength 23
- 3.41. Port output current, 6 mA Drive Strength 23
- 3.42. Port output current, 20 mA Drive Strength 23
- 3.43. Port output current, 0.5 mA Drive Strength 24
- 3.44. Port output current, 2 mA Drive Strength 24
- 3.45. Port output current, 6 mA Drive Strength 24
- 3.46. Port output current, 20 mA Drive Strength 24
- 3.47. Port output current, 0.5 mA Drive Strength 25
- 3.48. Port output current, 2 mA Drive Strength 25
- 3.49. Port output current, 6 mA Drive Strength 25
- 3.50. Port output current, 20 mA Drive Strength 25
- 3.51. Integral Non-Linearity (INL) 31
- 3.52. Differential Non-Linearity (DNL) 32
- 4.1. EFM32TG840 Pinout (top view, not to scale) 39
- 4.2. QFN64 45
- 5.1. QFN64 Chip Marking 47

List of Tables

1.1. Ordering Information	2
2.1. Configuration Summary	6
3.1. Absolute Maximum Ratings	8
3.2. General Operating Conditions	8
3.3. Environmental	9
3.4. Current Consumption	10
3.5. Energy Modes Transitions	17
3.6. Power Management	18
3.7. Flash	18
3.8. GPIO	19
3.9. LFXO	26
3.10. HFXO	26
3.11. LFRCO	27
3.12. HFRCO	27
3.13. ULFRCO	27
3.14. ADC	28
3.15. DAC	32
3.16. OPAMP	35
3.17. ACMP	35
3.18. VCMP	36
3.19. LCD	37
3.20. Digital Peripherals	37
4.1. Device Pinout	39
4.2. Alternate functionality overview	42
4.3. GPIO Pinout	45
4.4. QFN64 (Dimensions in mm)	46

List of Equations

3.1. Total ACMP Active Current	36
3.2. VCMP Trigger Level as a Function of Level Setting	36
3.3. Total LCD Current Based on Operational Mode and Internal Boost	37

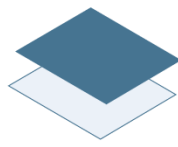

ENERGY[®]
micro

*Energy Micro AS
Sandakerveien 118
P.O. Box 4633 Nydalen
N-0405 Oslo
Norway*

www.energymicro.com