

## LM330

### 3-Terminal Positive Regulator

#### General Description

The LM330 5V 3-terminal positive voltage regulator features an ability to source 150 mA of output current with an input-output differential of 0.6V or less. Familiar regulator features such as current limit and thermal overload protection are also provided.

The low dropout voltage makes the LM330 useful for certain battery applications since this feature allows a longer battery discharge before the output falls out of regulation. For example, a battery supplying the regulator input voltage may discharge to 5.6V and still properly regulate the system and load voltage. Supporting this feature, the LM330 protects both itself and regulated systems from negative voltage inputs resulting from reverse installations of batteries.

Other protection features include line transient protection up to 26V, when the output actually shuts down to avoid damaging internal and external circuits. Also, the LM330 regulator cannot be harmed by a temporary mirror-image insertion.

#### Features

- Input-output differential less than 0.6V
- Output current of 150 mA
- Reverse battery protection
- Line transient protection
- Internal short circuit current limit
- Internal thermal overload protection
- Mirror-image insertion protection
- P+ Product Enhancement tested

#### Schematic and Connection Diagrams

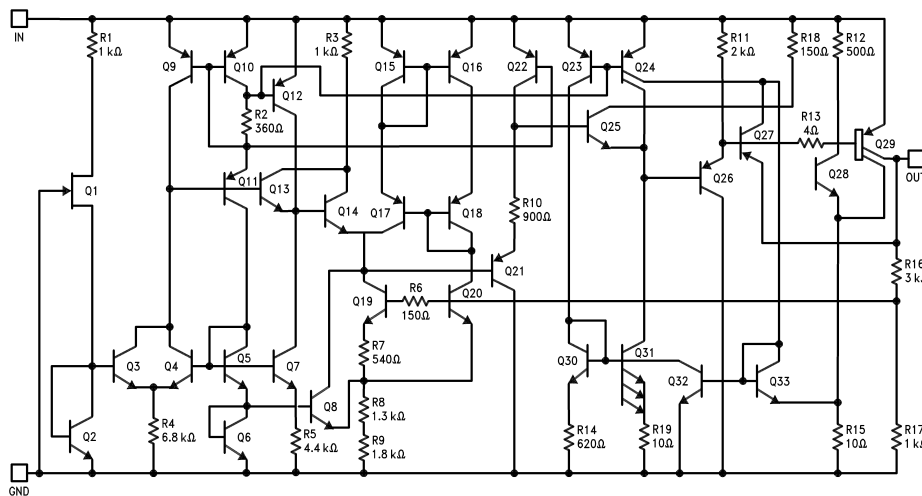

DS009306-1

(TO-220)  
Plastic Package

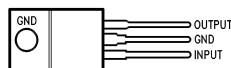

DS009306-2

Front View  
Order Number LM330T-5.0  
See NS Package Number T03B

### Absolute Maximum Ratings (Note 1)

If Military/Aerospace specified devices are required, please contact the National Semiconductor Sales Office/Distributors for availability and specifications.

Input Voltage	
Operating Range	26V
Line Transient Protection (1000 ms)	40V

Internal Power Dissipation	Internally Limited
Operating Temperature Range	0°C to +70°C
Maximum Junction Temperature	+125°C
Storage Temperature Range	-65°C to +150°C
Lead Temperature (Soldering, 10 sec.)	+300°C

### Electrical Characteristics (Note 2)

Symbol	Parameter	Conditions	Min	Typ	Max	Units
V <sub>o</sub>	Output Voltage	T <sub>j</sub> = 25°C	4.8	5	5.2	V
	Output Voltage Over Temp	5 < I <sub>o</sub> < 150 mA 6 < V <sub>IN</sub> < 26V; 0°C ≤ T <sub>j</sub> ≤ 100°C	4.75		5.25	
ΔV <sub>o</sub>	Line Regulation	9 < V <sub>IN</sub> < 16V, I <sub>o</sub> = 5 mA		7	25	mV
		6 < V <sub>IN</sub> < 26V, I <sub>o</sub> = 5 mA		30	60	
	Load Regulation	5 < I <sub>o</sub> < 150 mA		14	50	
	Long Term Stability			20		mV/1000 hrs
I <sub>o</sub>	Quiescent Current	I <sub>o</sub> = 10 mA		3.5	7	mA
		I <sub>o</sub> = 50 mA		5	11	
I <sub>o</sub> = 150 mA			18	40		
	Line Transient Reverse Polarity	V <sub>IN</sub> = 40V, R <sub>L</sub> = 100Ω, 1s V <sub>IN</sub> = -6V, R <sub>L</sub> = 100Ω		14 -80		
ΔI <sub>o</sub>	Quiescent Current Change	6 < V <sub>IN</sub> < 26V		10		%
V <sub>IN</sub>	Overvoltage Shutdown Voltage		26	38		V
	Max Line Transient			60		
		1s, V <sub>o</sub> ≤ 5.5V		50		
	Reverse Polarity Input Voltage	DC V <sub>o</sub> > -0.3V, R <sub>L</sub> = 100Ω		-30		
	Output Noise Voltage	10 Hz-100 kHz		50		μV
	Output Impedance	I <sub>o</sub> = 100 mADC + 10 mArms		200		mΩ
	Ripple Rejection			56		dB
	Current Limit		150	400	700	mA
	Dropout Voltage	I <sub>o</sub> = 150 mA		0.32	0.6	V
	Thermal Resistance	Junction to Case		4		°C/W
		Junction to Ambient		50		

**Note 1:** "Absolute Maximum Ratings" indicate limits beyond which damage to the device may occur. Operating Ratings indicate conditions for which the device is functional, but do not guarantee specific performance limits.

**Note 2:** Unless otherwise specified: V<sub>IN</sub> = 14V, I<sub>o</sub> = 150 mA, T<sub>j</sub> = 25°C, C1 = 0.1 μF, C2 = 10 μF. All characteristics except noise voltage and ripple rejection are measured using pulse techniques (t<sub>w</sub> ≤ 10 ms, duty cycle ≤ 5%). Output voltage changes due to changes in internal temperature must be taken into account separately.

# Typical Performance Characteristics

**Dropout Voltage**

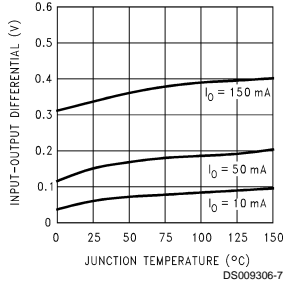

**Dropout Voltage**

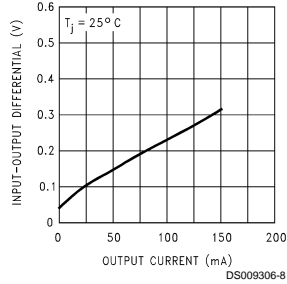

**Low Voltage Behavior**

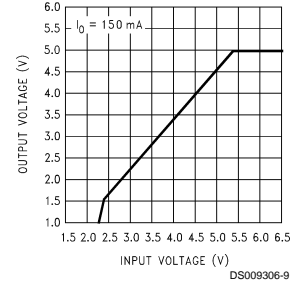

**High Voltage Behavior**

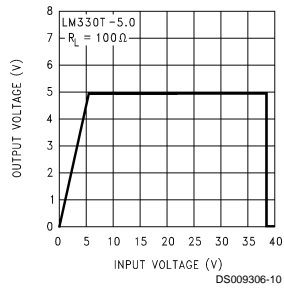

**Line Transient Response**

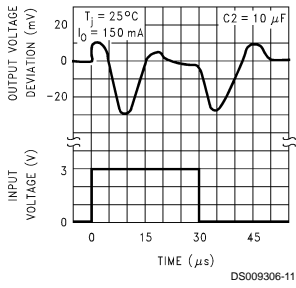

**Load Transient Response**

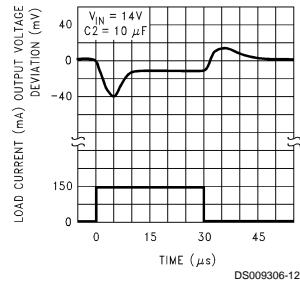

**Peak Output Current**

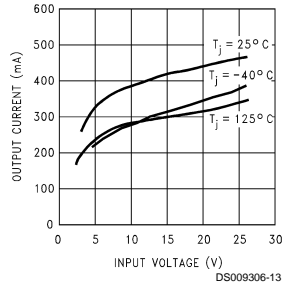

**Quiescent Current**

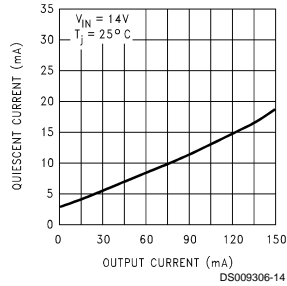

**Quiescent Current**

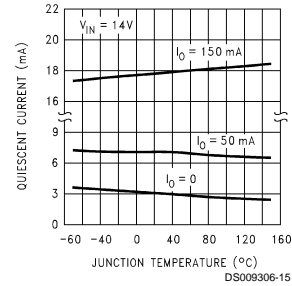

**Quiescent Current**

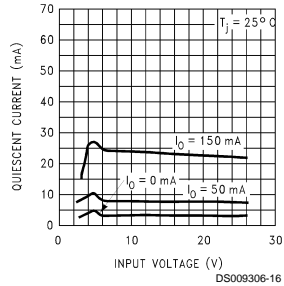

**Ripple Rejection**

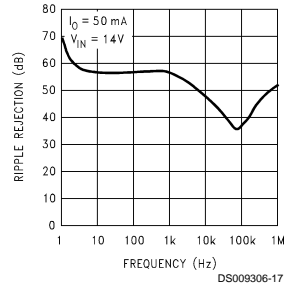

**Ripple Rejection**

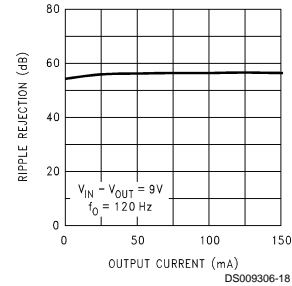

## Typical Performance Characteristics (Continued)

**Output Impedance**

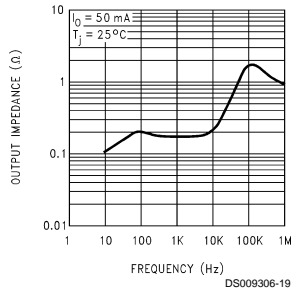

**Overvoltage Supply Current**

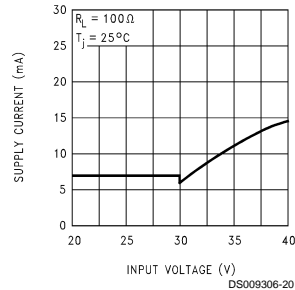

**Reverse Supply Current**

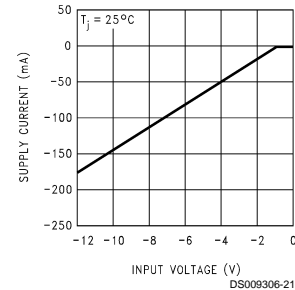

**Output at Reverse Supply**

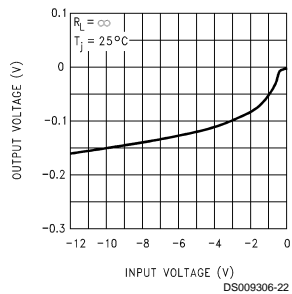

**Output at Overvoltage**

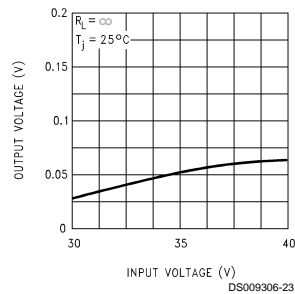

**Output Voltage (Normalized to 5V at T<sub>J</sub> = 25°C)**

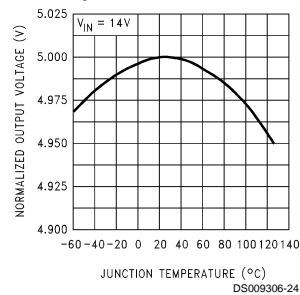

## Typical Applications

The LM330 is designed specifically to operate at lower input to output voltages. The device is designed utilizing a power lateral PNP transistor which reduces dropout voltage from 2.0V to 0.3V when compared to IC regulators using NPN pass transistors. Since the LM330 can operate at a much lower input voltage, the device power dissipation is reduced, heat sinking can be simpler and device reliability improved through lower chip operating temperature. Also, a cost savings can be utilized through use of lower power/voltage components. In applications utilizing battery power, the LM330 allows the battery voltage to drop to within 0.3V of output voltage prior to the voltage regulator dropping out of regulation.

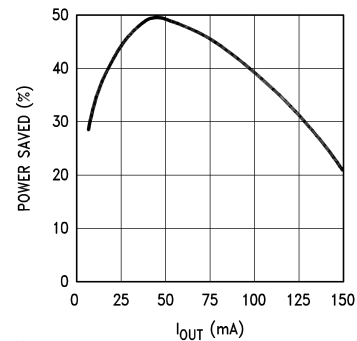

Note: Compared to IC regulator with 2.0V dropout voltage and  $I_{Omax} = 6.0$  mA.

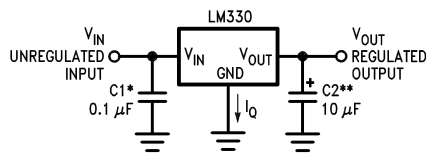

\* Required if regulator is located far from power supply filter.

\*\* C2 may be either an Aluminum or Tantalum type capacitor but must be rated to operate at  $-40^{\circ}\text{C}$  to guarantee regulator stability to that temperature extreme. 10  $\mu\text{F}$  is the minimum value required for stability and may be increased without bound. Locate as close as possible to the regulation.

**Physical Dimensions** inches (millimeters) unless otherwise noted

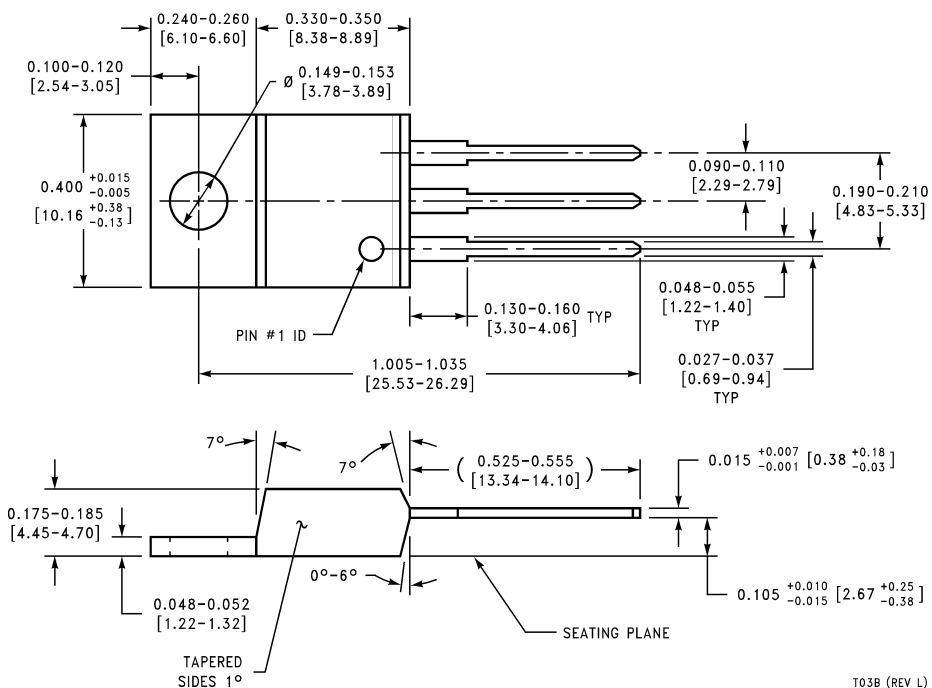

**TO Plastic Package**  
**Order Number LM330T-5.0**  
**NS Package Number T03B**

**LIFE SUPPORT POLICY**

NATIONAL'S PRODUCTS ARE NOT AUTHORIZED FOR USE AS CRITICAL COMPONENTS IN LIFE SUPPORT DEVICES OR SYSTEMS WITHOUT THE EXPRESS WRITTEN APPROVAL OF THE PRESIDENT AND GENERAL COUNSEL OF NATIONAL SEMICONDUCTOR CORPORATION. As used herein:

1. Life support devices or systems are devices or systems which, (a) are intended for surgical implant into the body, or (b) support or sustain life, and whose failure to perform when properly used in accordance with instructions for use provided in the labeling, can be reasonably expected to result in a significant injury to the user.
2. A critical component is any component of a life support device or system whose failure to perform can be reasonably expected to cause the failure of the life support device or system, or to affect its safety or effectiveness.

 **National Semiconductor Corporation**  
 Americas  
 Tel: 1-800-272-9959  
 Fax: 1-800-737-7018  
 Email: support@nsc.com  
 www.national.com

**National Semiconductor Europe**  
 Fax: +49 (0) 1 80-530 85 86  
 Email: europe.support@nsc.com  
 Deutsch Tel: +49 (0) 1 80-530 85 85  
 English Tel: +49 (0) 1 80-532 78 32  
 Français Tel: +49 (0) 1 80-532 93 58  
 Italiano Tel: +49 (0) 1 80-534 16 80

**National Semiconductor Asia Pacific Customer Response Group**  
 Tel: 65-2544466  
 Fax: 65-2504466  
 Email: sea.support@nsc.com

**National Semiconductor Japan Ltd.**  
 Tel: 81-3-5639-7560  
 Fax: 81-3-5639-7507