

LM7301

Low Power, 4 MHz GBW, Rail-to-Rail Input-Output Operational Amplifier in TinyPak™ Package

General Description

The LM7301 provides high performance in a wide range of applications. The LM7301 offers greater than rail-to-rail input range, full rail-to-rail output swing, large capacitive load driving ability and low distortion.

With only 0.6 mA supply current, the 4 MHz gain-bandwidth of this device supports new portable applications where higher power devices unacceptably drain battery life.

The LM7301 can be driven by voltages that exceed both power supply rails, thus eliminating concerns over exceeding the common-mode voltage range. The rail-to-rail output swing capability provides the maximum possible dynamic range at the output. This is particularly important when operating on low supply voltages.

Operating on supplies of 1.8V–32V, the LM7301 is excellent for a very wide range of applications in low power systems.

Placing the amplifier right at the signal source reduces board size and simplifies signal routing. The LM7301 fits easily on low profile PCMCIA cards.

Features

- at $V_S = 5V$ (Typ unless otherwise noted)
 - Tiny 5-pin SOT23 package saves space
 - Greater than Rail-to-Rail Input CMVR $-0.25V$ to $5.25V$
 - Rail-to-Rail Output Swing $0.07V$ to $4.93V$
 - Wide Gain-Bandwidth 4 MHz
 - Low Supply Current 0.60 mA
 - Wide Supply Range $1.8V$ to $32V$
 - High PSRR 104 dB
 - High CMRR 93 dB
 - Excellent Gain 97 dB

Applications

- Portable instrumentation
- Signal conditioning amplifiers/ADC buffers
- Active filters
- Modems
- PCMCIA cards

Connection Diagrams

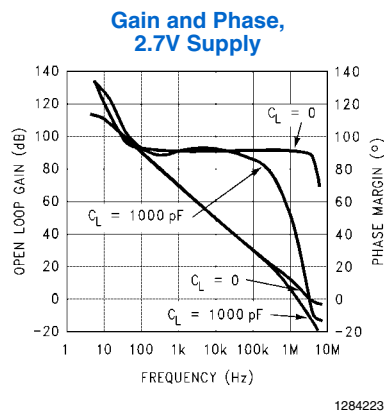
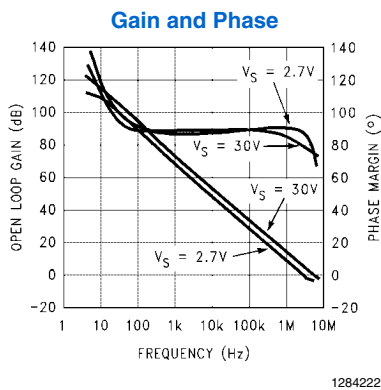
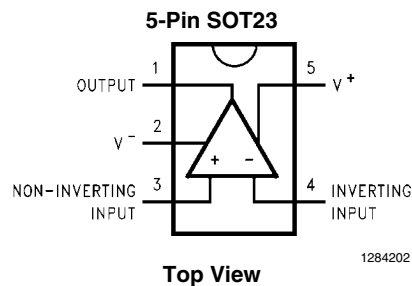
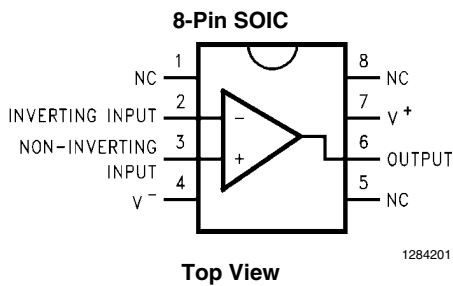

TinyPak™ is a trademark of National Semiconductor Corporation.

Absolute Maximum Ratings (Note 1)

If Military/Aerospace specified devices are required, please contact the National Semiconductor Sales Office/Distributors for availability and specifications.

ESD Tolerance (Note 2)	
Human Body Model	2500V
Differential Input Voltage	15V
Voltage at Input/Output Pin	(V+) + 0.3V, (V-) -0.3V
Supply Voltage (V+ - V-)	35V
Current at Input Pin	±10 mA
Current at Output Pin (Note 3)	±20 mA
Current at Power Supply Pin	25 mA
Soldering Information	
Infrared or Convection (20 sec)	235°C

Wave Soldering Lead Temp. (10 sec)	260°C
Storage Temperature Range	-65°C to +150°C
Junction Temperature (Note 4)	150°C

Operating Ratings (Note 1)

Supply Voltage	$1.8V \leq V_S \leq 32V$
Operating Temperature Range (Note 4)	-40°C to +85°C
Package Thermal Resistance (θ_{JA}) (Note 4)	
5-Pin SOT23	325°C/W
8-Pin SOIC	165°C/W

5.0V DC Electrical Characteristics (Note 7)

Unless otherwise specified, all limits guaranteed for $T_A = 25^\circ\text{C}$, $V^+ = 5V$, $V^- = 0V$, $V_{CM} = V_O = V^+/2$ and $R_L > 1M\Omega$ to $V^+/2$.

Boldface limits apply at the temperature extremes.

Symbol	Parameter	Conditions	LM7301		Units
			Typ (Note 5)	Limit (Note 6)	
V_{OS}	Input Offset Voltage		0.03	6 8	mV max
TCV_{OS}	Input Offset Voltage Average Drift		2		$\mu\text{V}/^\circ\text{C}$
I_B	Input Bias Current	$V_{CM} = 0V$	90	200 250	nA max
		$V_{CM} = 5V$	-40	-75 -85	nA min
I_{OS}	Input Offset Current	$V_{CM} = 0V$	0.7	70 80	nA max
		$V_{CM} = 5V$	0.7	55 65	
R_{IN}	Input Resistance, CM	$0V \leq V_{CM} \leq 5V$	39		M Ω
CMRR	Common Mode Rejection Ratio	$0V \leq V_{CM} \leq 5V$	88	70 67	dB min
		$0V \leq V_{CM} \leq 3.5V$	93		
PSRR	Power Supply Rejection Ratio	$2.2V \leq V^+ \leq 30V$	104	87 84	
V_{CM}	Input Common-Mode Voltage Range	CMRR ≥ 65 dB	5.1		V
			-0.1		V
A_V	Large Signal Voltage Gain	$R_L = 10\text{ k}\Omega$ $V_O = 4.0V_{PP}$	71	14 10	V/mV min
V_O	Output Swing	$R_L = 10\text{ k}\Omega$	0.07	0.12 0.15	V max
			4.93	4.88 4.85	V min
		$R_L = 2\text{ k}\Omega$	0.14	0.20 0.22	V max
			4.87	4.80 4.78	V min

Symbol	Parameter	Conditions	LM7301		Units
			Typ (Note 5)	Limit (Note 6)	
I_{SC}	Output Short Circuit Current	Sourcing	11.0	8.0 5.5	mA min
		Sinking	9.5	6.0 5.0	mA min
I_S	Supply Current		0.60	1.10 1.24	mA max

AC Electrical Characteristics (Note 7)

$T_A = 25^\circ\text{C}$, $V^+ = 2.2\text{V}$ to 30V , $V^- = 0\text{V}$, $V_{CM} = V_O = V^+/2$ and $R_L > 1\text{M}\Omega$ to $V^+/2$

Symbol	Parameter	Conditions	Typ (Note 5)	Units
SR	Slew Rate	$\pm 4\text{V}$ Step @ $V_S \pm 6\text{V}$	1.25	$\text{V}/\mu\text{s}$
GBW	Gain-Bandwidth Product	$f = 100\text{ kHz}$, $R_L = 10\text{ k}\Omega$	4	MHz
e_n	Input-Referred Voltage Noise	$f = 1\text{ kHz}$	36	$\frac{\text{nV}}{\sqrt{\text{Hz}}}$
i_n	Input-Referred Current Noise	$f = 1\text{ kHz}$	0.24	$\frac{\text{pA}}{\sqrt{\text{Hz}}}$
T.H.D.	Total Harmonic Distortion	$f = 10\text{ kHz}$	0.006	%

2.2V DC Electrical Characteristics (Note 7)

Unless otherwise specified, all limits guaranteed for $T_A = 25^\circ\text{C}$, $V^+ = 2.2\text{V}$, $V^- = 0\text{V}$, $V_{\text{CM}} = V_O = V^+/2$ and $R_L > 1\text{M}\Omega$ to $V^+/2$.

Boldface limits apply at the temperature extremes.

Symbol	Parameter	Conditions	LM7301		Units
			Typ (Note 5)	Limit (Note 6)	
V_{OS}	Input Offset Voltage		0.04	6 8	mV max
TCV_{OS}	Input Offset Voltage Average Drift		2		$\mu\text{V}/^\circ\text{C}$
I_{B}	Input Bias Current	$V_{\text{CM}} = 0\text{V}$	89	200 250	nA max
		$V_{\text{CM}} = 2.2\text{V}$	-35	-75 -85	nA min
I_{OS}	Input Offset Current	$V_{\text{CM}} = 0\text{V}$	0.8	70 80	nA max
		$V_{\text{CM}} = 2.2\text{V}$	0.4	55 65	
R_{IN}	Input Resistance	$0\text{V} \leq V_{\text{CM}} \leq 2.2\text{V}$	18		$\text{M}\Omega$
CMRR	Common Mode Rejection Ratio	$0\text{V} \leq V_{\text{CM}} \leq 2.2\text{V}$	82	60 56	dB min
			PSRR	Power Supply Rejection Ratio	$2.2\text{V} \leq V^+ \leq 30\text{V}$
V_{CM}	Input Common-Mode Voltage Range	CMRR > 60 dB	2.3		V
			-0.1		V
A_{V}	Large Signal Voltage Gain	$R_L = 10\text{ k}\Omega$ $V_O = 1.6\text{V}_{\text{PP}}$	46	6.5 5.4	V/mV min
			V_{O}	Output Swing	$R_L = 10\text{ k}\Omega$
2.15	2.10 2.00	V min			
$R_L = 2\text{ k}\Omega$	0.09	0.13 0.14			V max
	2.10	2.07 2.00			V min
I_{SC}	Output Short Circuit Current	Sourcing	10.9	8.0 5.5	mA min
		Sinking	7.7	6.0 5.0	mA min
I_{S}	Supply Current		0.57	0.97 1.24	mA max

30V DC Electrical Characteristics (Note 7)

Unless otherwise specified, all limits guaranteed for $T_A = 25^\circ\text{C}$, $V^+ = 30\text{V}$, $V^- = 0\text{V}$, $V_{CM} = V_O = V^+/2$ and $R_L > 1\text{M}\Omega$ to $V^+/2$.

Boldface limits apply at the temperature extremes.

Symbol	Parameter	Conditions	LM7301		Units
			Typ (Note 5)	Limit (Note 6)	
V_{OS}	Input Offset Voltage		0.04	6 8	mV max
TCV_{OS}	Input Offset Voltage Average Drift		2		$\mu\text{V}/^\circ\text{C}$
I_B	Input Bias Current	$V_{CM} = 0\text{V}$	103	300 500	nA max
		$V_{CM} = 30\text{V}$	-50	-100 -200	nA min
I_{OS}	Input Offset Current	$V_{CM} = 0\text{V}$	1.2	90 190	nA max
		$V_{CM} = 30\text{V}$	0.5	65 135	nA max
R_{IN}	Input Resistance	$0\text{V} \leq V_{CM} \leq 30\text{V}$	200		$\text{M}\Omega$
CMRR	Common Mode Rejection Ratio	$0\text{V} \leq V_{CM} \leq 30\text{V}$	104	80 78	dB min
		$0\text{V} \leq V_{CM} \leq 27\text{V}$	115	90 88	
PSRR	Power Supply Rejection Ratio	$2.2\text{V} \leq V^+ \leq 30\text{V}$	104	87 84	
V_{CM}	Input Common-Mode Voltage Range	CMRR > 80 dB	30.1		V
			-0.1		V
A_V	Large Signal Voltage Gain	$R_L = 10\text{ k}\Omega$ $V_O = 28V_{PP}$	105	30 20	V/mV min
V_O	Output Swing	$R_L = 10\text{ k}\Omega$	0.16	0.275 0.375	V max
			29.8	29.75 28.65	V min
I_{SC}	Output Short Circuit Current	Sourcing (Note 4)	11.7	8.8 6.5	mA min
		Sinking (Note 4)	11.5	8.2 6.0	mA min
I_S	Supply Current		0.72	1.30 1.35	mA max

Note 1: Absolute Maximum Ratings indicate limits beyond which damage to the device may occur. Operating Ratings indicate conditions for which the device is intended to be functional, but specific performance is not guaranteed. For guaranteed specifications and the test conditions, see the Electrical Characteristics.

Note 2: Human Body Model, applicable std. MIL-STD-883, Method 3015.7.

Note 3: Applies to both single-supply and split-supply operation. Continuous short circuit operation at elevated ambient temperature can result in exceeding the maximum allowed junction temperature of 150°C .

Note 4: The maximum power dissipation is a function of $T_{J(\text{MAX})}$, θ_{JA} , and T_A . The maximum allowable power dissipation at any ambient temperature is $P_D = (T_{J(\text{MAX})} - T_A)/\theta_{JA}$. All numbers apply for packages soldered directly into a PC board.

Note 5: Typical values represent the most likely parametric norm as determined at the time of characterization. Actual typical values may vary over time and will also depend on the application and configuration. The typical values are not tested and are not guaranteed on shipped production material.

Note 6: All limits are guaranteed by testing or statistical analysis.

Note 7: Electrical Table values apply only for factory testing conditions at the temperature indicated. Factory testing conditions result in very limited self-heating of the devices such that $T_J = T_A$. No guarantee of parametric performance is indicated in the electrical tables under conditions of internal self-heating where $T_J > T_A$.

Typical Performance Characteristics $T_A = 25^\circ\text{C}$, $R_L = 1\text{ M}\Omega$ unless otherwise specified

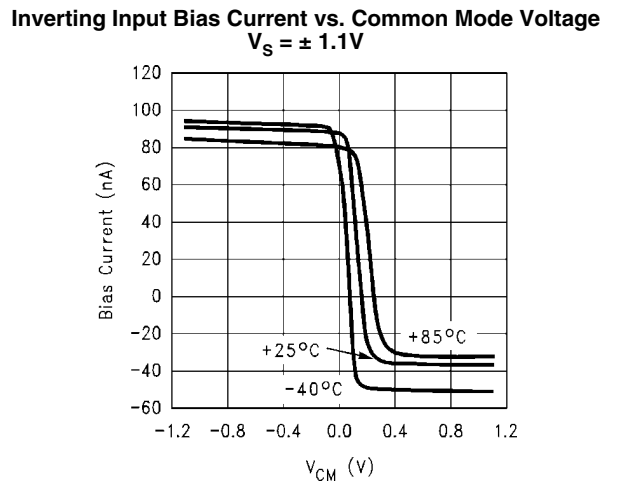
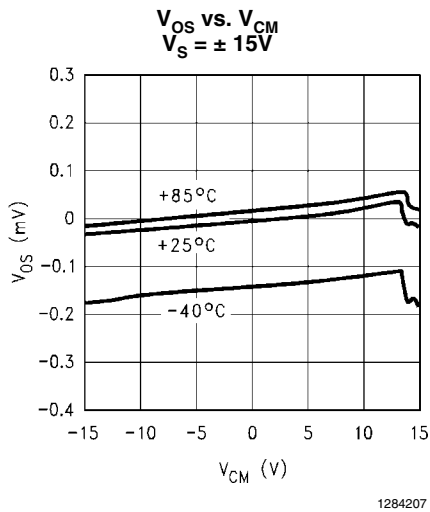
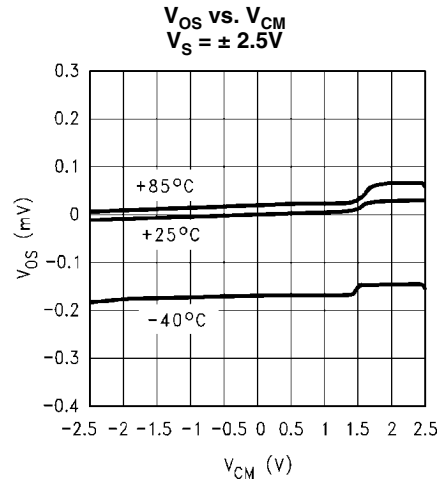
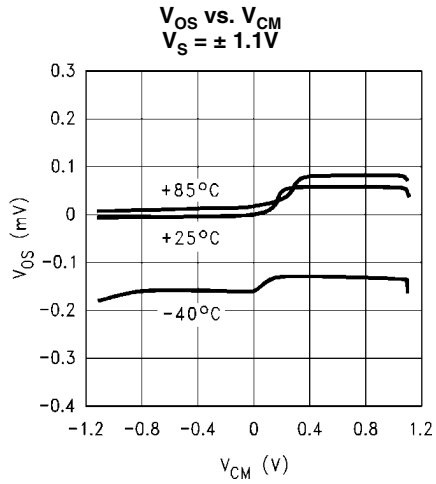
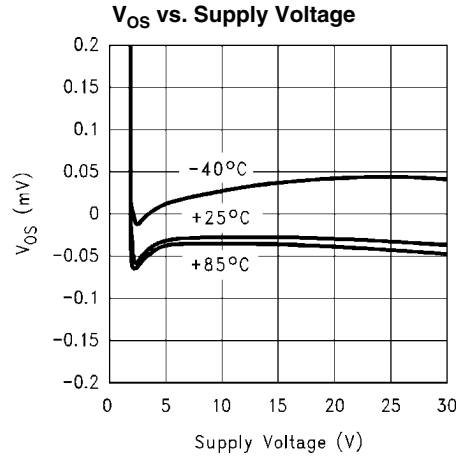
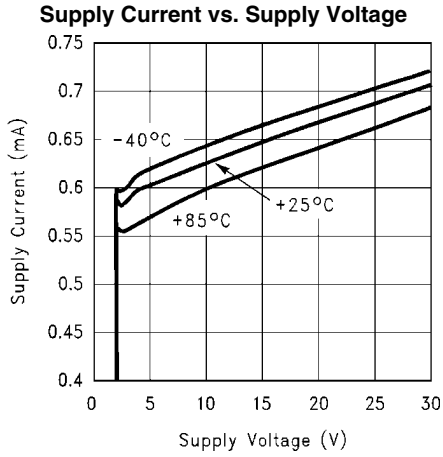

Non-Inverting Input Bias Current vs. Common Mode Voltage
 $V_S = \pm 1.1V$

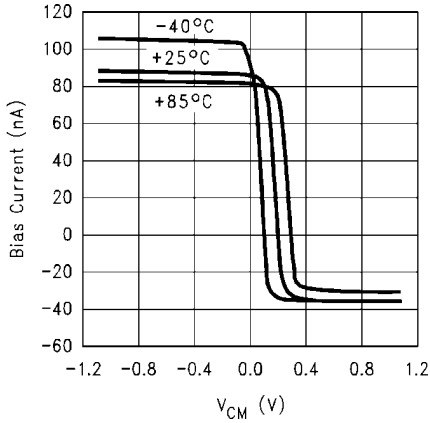

1284209

Inverting Input Bias Current vs. Common Mode Voltage
 $V_S = \pm 2.5V$

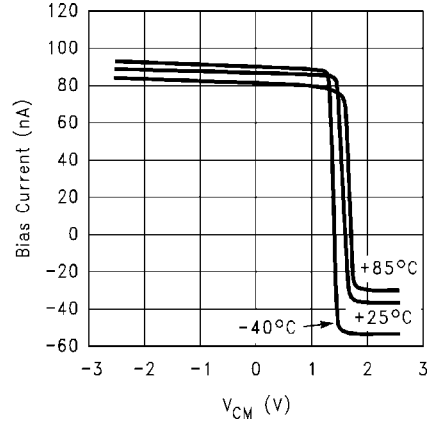

1284210

Non-Inverting Input Bias Current vs. Common Mode Voltage
 $V_S = \pm 2.5V$

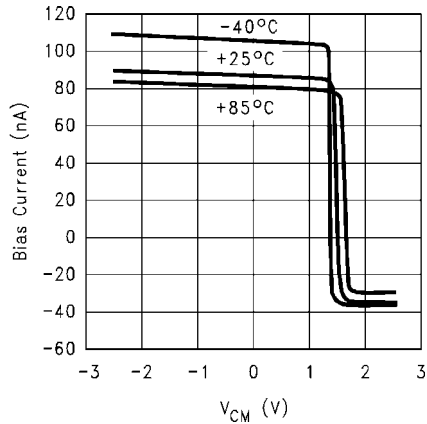

1284211

Non-Inverting Input Bias Current vs. Common Mode Voltage
 $V_S = \pm 15V$

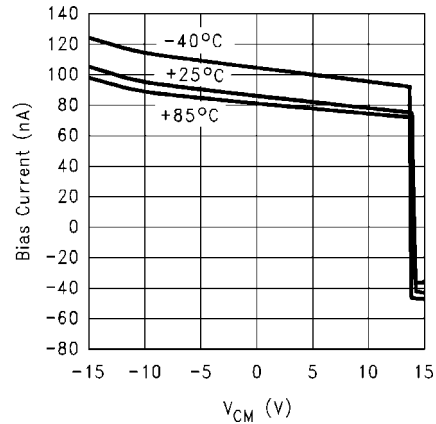

1284212

Inverting Input Bias Current vs. Common Mode Voltage
 $V_S = \pm 15V$

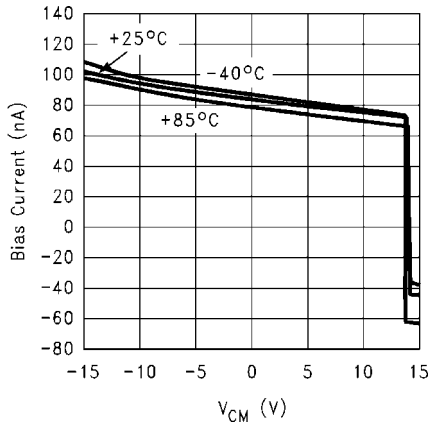

1284213

V_O vs. I_O
 $V_S = \pm 1.1V$

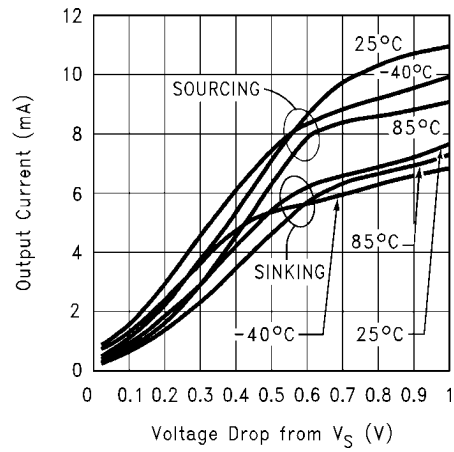

1284224

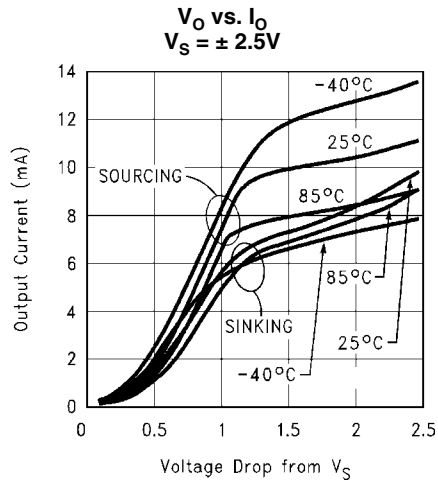

1284225

Short Circuit Current vs. Supply Voltage

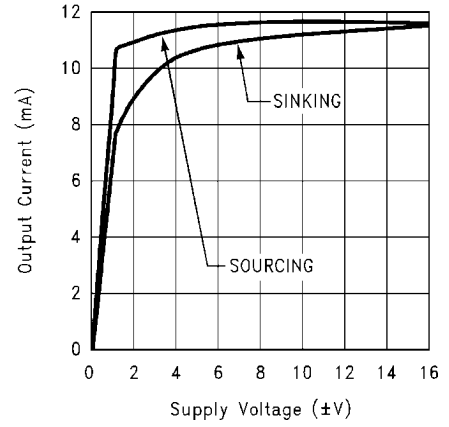

1284226

Voltage Noise vs. Frequency

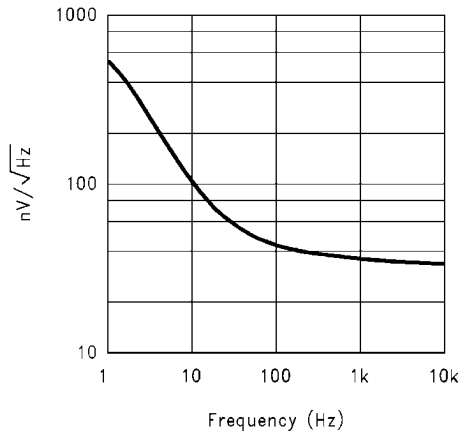

1284214

Current Noise vs. Frequency

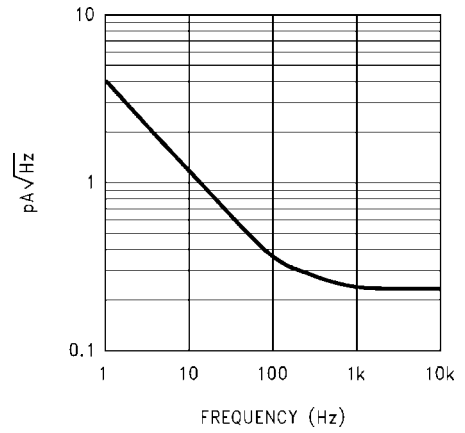

1284215

Gain and Phase

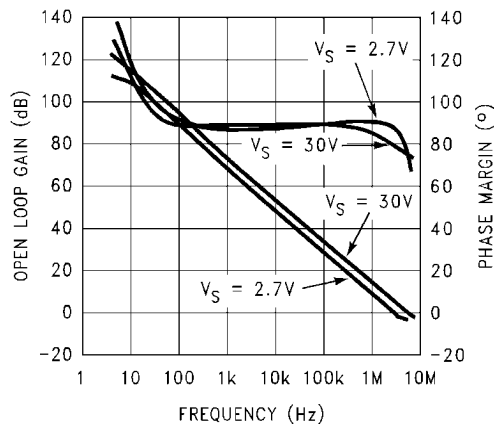

1284222

Gain and Phase, 2.7V Supply

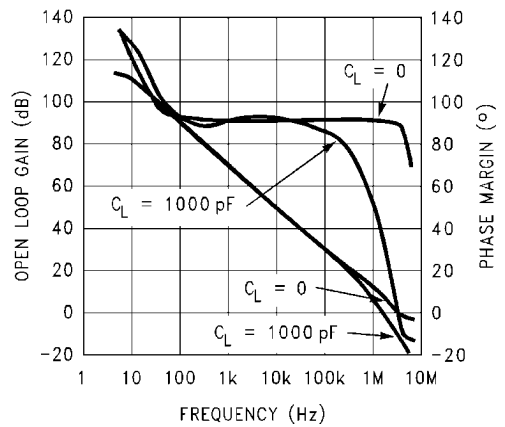

1284223

Applications Information

GENERAL INFORMATION

Low supply current and wide bandwidth, greater than rail-to-rail input range, full rail-to-rail output, good capacitive load driving ability, wide supply voltage and low distortion all make the LM7301 ideal for many diverse applications.

The high common-mode rejection ratio and full rail-to-rail input range provides precision performance when operated in non-inverting applications where the common-mode error is added directly to the other system errors.

CAPACITIVE LOAD DRIVING

The LM7301 has the ability to drive large capacitive loads. For example, 1000 pF only reduces the phase margin to about 25 degrees.

TRANSIENT RESPONSE

The LM7301 offers a very clean, well-behaved transient response. *Figures 1, 2, 3, 4, 5, 6* show the response when operated at gains of +1 and -1 when handling both small and large signals. The large phase margin, typically 70 to 80 degrees, assures clean and symmetrical response. In the large signal scope photos, *Figure 1* and *Figure 4*, the input signal is set to 4.8V. Note that the output goes to within 100 mV of the supplies cleanly and without overshoot. In the small signal samples, the response is clean, with only slight overshoot when used as a follower. *Figure 3* and *Figure 6* are the circuits used to make these photos.

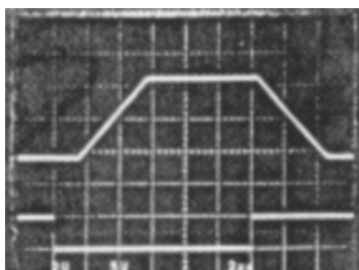

1284216

FIGURE 1.

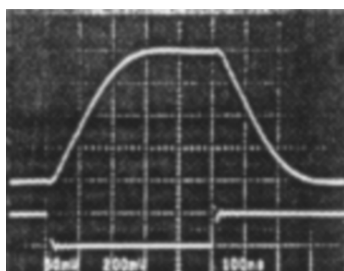

1284217

FIGURE 2.

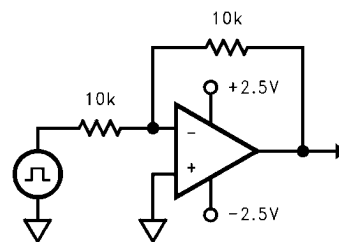

1284218

FIGURE 3.

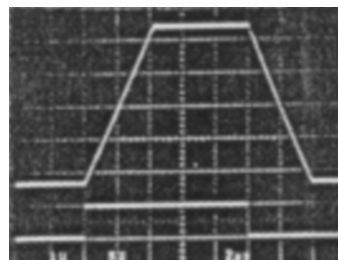

1284219

FIGURE 4.

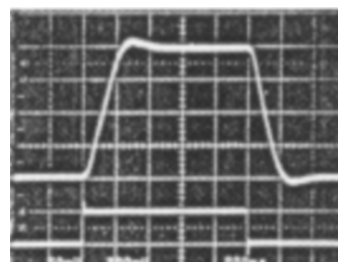

1284220

FIGURE 5.

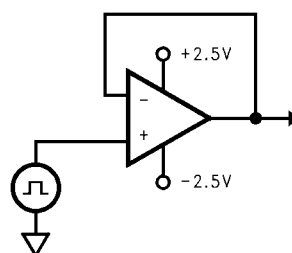

1284221

FIGURE 6.

POWER DISSIPATION

Although the LM7301 has internal output current limiting, shorting the output to ground when operating on a +30V power supply will cause the op amp to dissipate about 350 mW. This is a worst-case example. In the 8-pin SOIC package, this will cause a temperature rise of 58°C. In the 5-pin SOT23 package, the higher thermal resistance will cause a calculated rise of 113°C. This can raise the junction temperature to above the absolute maximum temperature of 150°C.

Operating from split supplies greatly reduces the power dissipated when the output is shorted. Operating on $\pm 15V$ supplies can only cause a temperature rise of 29°C in the 8-pin SOIC and 57°C in the 5-pin SOT23 package, assuming the short is to ground.

SPICE Macromodel

A SPICE macromodel for this and many other National Semiconductor operational amplifiers is available, at no charge, from the NSC Customer Support Center at 800-272-9959 or on the World Wide Web at <http://www.national.com/models>.

WIDE SUPPLY RANGE

The high power-supply rejection ratio (PSRR) and common-mode rejection ratio (CMRR) provide precision performance when operated on battery or other unregulated supplies. This advantage is further enhanced by the very wide supply range (2.2V–30V, guaranteed) offered by the LM7301. In situations where highly variable or unregulated supplies are present, the excellent PSRR and wide supply range of the LM7301 benefit the system designer with continued precision performance, even in such adverse supply conditions.

SPECIFIC ADVANTAGES OF 5-Pin SOT23 (TinyPak)

The obvious advantage of the 5-pin SOT23, TinyPak, is that it can save board space, a critical aspect of any portable or miniaturized system design. The need to decrease overall system size is inherent in any handheld, portable, or lightweight system application.

Furthermore, the low profile can help in height limited designs, such as consumer hand-held remote controls, sub-notebook computers, and PCMCIA cards.

An additional advantage of the tiny package is that it allows better system performance due to ease of package placement. Because the tiny package is so small, it can fit on the board right where the op amp needs to be placed for optimal performance, unconstrained by the usual space limitations. This optimal placement of the tiny package allows for many system enhancements, not easily achieved with the constraints of a larger package. For example, problems such as system noise due to undesired pickup of digital signals can be easily reduced or mitigated. This pick-up problem is often caused by long wires in the board layout going to or from an op amp. By placing the tiny package closer to the signal

source and allowing the LM7301 output to drive the long wire, the signal becomes less sensitive to such pick-up. An overall reduction of system noise results.

Often times system designers try to save space by using dual or quad op amps in their board layouts. This causes a complicated board layout due to the requirement of routing several signals to and from the same place on the board. Using the tiny op amp eliminates this problem.

Additional space savings parts are available in tiny packages from National Semiconductor, including low power amplifiers, precision voltage references, and voltage regulators.

LOW DISTORTION, HIGH OUTPUT DRIVE CAPABILITY

The LM7301 offers superior low-distortion performance, with a total-harmonic-distortion-plus-noise of 0.06% at $f = 10\text{ kHz}$. The advantage offered by the LM7301 is its low distortion levels, even at high output current and low load resistance.

Typical Applications

HANDHELD REMOTE CONTROLS

The LM7301 offers outstanding specifications for applications requiring good speed/power trade-off. In applications such as remote control operation, where high bandwidth and low power consumption are needed. The LM7301 performance can easily meet these requirements.

OPTICAL LINE ISOLATION FOR MODEMS

The combination of the low distortion and good load driving capabilities of the LM7301 make it an excellent choice for driving opto-coupler circuits to achieve line isolation for modems. This technique prevents telephone line noise from coupling onto the modem signal. Superior isolation is achieved by coupling the signal optically from the computer modem to the telephone lines; however, this also requires a low distortion at relatively high currents. Due to its low distortion at high output drive currents, the LM7301 fulfills this need, in this and in other telecom applications.

REMOTE MICROPHONE IN PERSONAL COMPUTERS

Remote microphones in Personal Computers often utilize a microphone at the top of the monitor which must drive a long cable in a high noise environment. One method often used to reduce the noise is to lower the signal impedance, which reduces the noise pickup. In this configuration, the amplifier usually requires 30 db–40 db of gain, at bandwidths higher than most low-power CMOS parts can achieve. The LM7301 offers the tiny package, higher bandwidths, and greater output drive capability than other rail-to-rail input/output parts can provide for this application.

Ordering Information

Package	Part Number	Package Marking	Transport Media	NSC Drawing
8-Pin SOIC	LM7301IM	LM7301IM	95 Units/Rail	M08A
	LM7301IMX		2.5k Units Tape and Reel	
5-Pin SOT23	LM7301IM5	A04A	1k Units Tape and Reel	MF05A
	LM7301IM5X		3k Units Tape and Reel	

Physical Dimensions inches (millimeters) unless otherwise noted

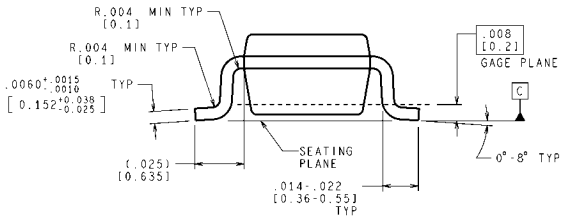
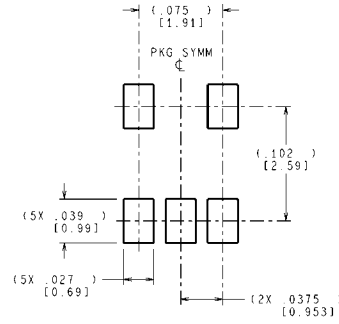
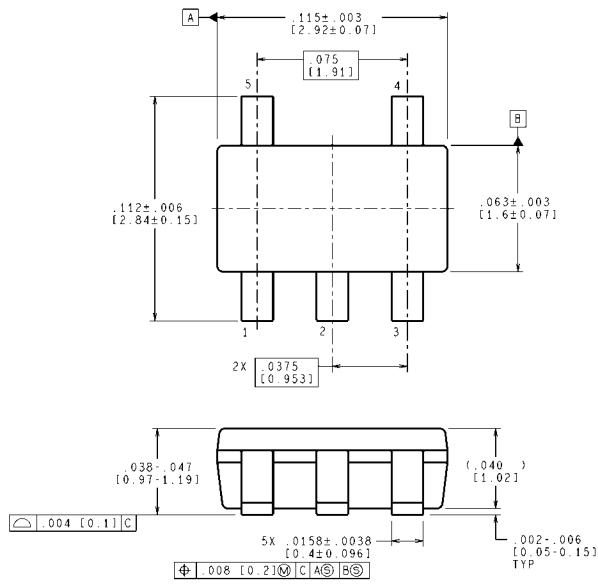

CONTROLLING DIMENSION IS INCH
VALUES IN [] ARE MILLIMETERS
DIMENSIONS IN () FOR REFERENCE ONLY

MF05A (Rev D)

5-Pin SOT23 Package
NS Package Number MF05A

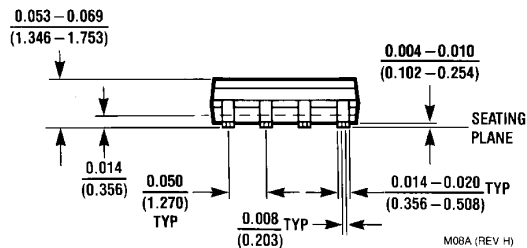
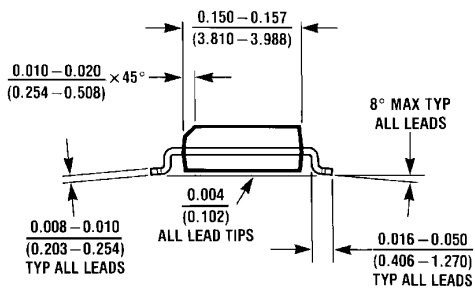
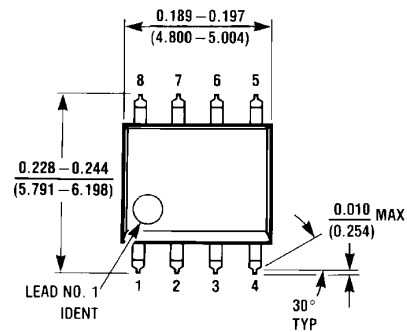

M08A (REV H)

8-Pin SOIC
NS Package Number M08A

Notes

For more National Semiconductor product information and proven design tools, visit the following Web sites at:

Products		Design Support	
Amplifiers	www.national.com/amplifiers	WEBENCH® Tools	www.national.com/webench
Audio	www.national.com/audio	App Notes	www.national.com/appnotes
Clock and Timing	www.national.com/timing	Reference Designs	www.national.com/refdesigns
Data Converters	www.national.com/adc	Samples	www.national.com/samples
Interface	www.national.com/interface	Eval Boards	www.national.com/evalboards
LVDS	www.national.com/lvds	Packaging	www.national.com/packaging
Power Management	www.national.com/power	Green Compliance	www.national.com/quality/green
Switching Regulators	www.national.com/switchers	Distributors	www.national.com/contacts
LDOs	www.national.com/ldo	Quality and Reliability	www.national.com/quality
LED Lighting	www.national.com/led	Feedback/Support	www.national.com/feedback
Voltage Reference	www.national.com/vref	Design Made Easy	www.national.com/easy
PowerWise® Solutions	www.national.com/powerwise	Solutions	www.national.com/solutions
Serial Digital Interface (SDI)	www.national.com/sdi	Mil/Aero	www.national.com/milaero
Temperature Sensors	www.national.com/tempensors	SolarMagic™	www.national.com/solarmagic
Wireless (PLL/VCO)	www.national.com/wireless	PowerWise® Design University	www.national.com/training

THE CONTENTS OF THIS DOCUMENT ARE PROVIDED IN CONNECTION WITH NATIONAL SEMICONDUCTOR CORPORATION ("NATIONAL") PRODUCTS. NATIONAL MAKES NO REPRESENTATIONS OR WARRANTIES WITH RESPECT TO THE ACCURACY OR COMPLETENESS OF THE CONTENTS OF THIS PUBLICATION AND RESERVES THE RIGHT TO MAKE CHANGES TO SPECIFICATIONS AND PRODUCT DESCRIPTIONS AT ANY TIME WITHOUT NOTICE. NO LICENSE, WHETHER EXPRESS, IMPLIED, ARISING BY ESTOPPEL OR OTHERWISE, TO ANY INTELLECTUAL PROPERTY RIGHTS IS GRANTED BY THIS DOCUMENT.

TESTING AND OTHER QUALITY CONTROLS ARE USED TO THE EXTENT NATIONAL DEEMS NECESSARY TO SUPPORT NATIONAL'S PRODUCT WARRANTY. EXCEPT WHERE MANDATED BY GOVERNMENT REQUIREMENTS, TESTING OF ALL PARAMETERS OF EACH PRODUCT IS NOT NECESSARILY PERFORMED. NATIONAL ASSUMES NO LIABILITY FOR APPLICATIONS ASSISTANCE OR BUYER PRODUCT DESIGN. BUYERS ARE RESPONSIBLE FOR THEIR PRODUCTS AND APPLICATIONS USING NATIONAL COMPONENTS. PRIOR TO USING OR DISTRIBUTING ANY PRODUCTS THAT INCLUDE NATIONAL COMPONENTS, BUYERS SHOULD PROVIDE ADEQUATE DESIGN, TESTING AND OPERATING SAFEGUARDS.

EXCEPT AS PROVIDED IN NATIONAL'S TERMS AND CONDITIONS OF SALE FOR SUCH PRODUCTS, NATIONAL ASSUMES NO LIABILITY WHATSOEVER, AND NATIONAL DISCLAIMS ANY EXPRESS OR IMPLIED WARRANTY RELATING TO THE SALE AND/OR USE OF NATIONAL PRODUCTS INCLUDING LIABILITY OR WARRANTIES RELATING TO FITNESS FOR A PARTICULAR PURPOSE, MERCHANTABILITY, OR INFRINGEMENT OF ANY PATENT, COPYRIGHT OR OTHER INTELLECTUAL PROPERTY RIGHT.

LIFE SUPPORT POLICY

NATIONAL'S PRODUCTS ARE NOT AUTHORIZED FOR USE AS CRITICAL COMPONENTS IN LIFE SUPPORT DEVICES OR SYSTEMS WITHOUT THE EXPRESS PRIOR WRITTEN APPROVAL OF THE CHIEF EXECUTIVE OFFICER AND GENERAL COUNSEL OF NATIONAL SEMICONDUCTOR CORPORATION. As used herein:

Life support devices or systems are devices which (a) are intended for surgical implant into the body, or (b) support or sustain life and whose failure to perform when properly used in accordance with instructions for use provided in the labeling can be reasonably expected to result in a significant injury to the user. A critical component is any component in a life support device or system whose failure to perform can be reasonably expected to cause the failure of the life support device or system or to affect its safety or effectiveness.

National Semiconductor and the National Semiconductor logo are registered trademarks of National Semiconductor Corporation. All other brand or product names may be trademarks or registered trademarks of their respective holders.

Copyright© 2009 National Semiconductor Corporation

For the most current product information visit us at www.national.com



National Semiconductor Americas Technical Support Center
Email: support@nsc.com
Tel: 1-800-272-9959

National Semiconductor Europe Technical Support Center
Email: europe.support@nsc.com

National Semiconductor Asia Pacific Technical Support Center
Email: ap.support@nsc.com

National Semiconductor Japan Technical Support Center
Email: jpn.feedback@nsc.com