

1.5V to 3.6V, 312.5ksps, 1-Channel True-Differential/ 2-Channel Single-Ended, 12-Bit, SAR ADCs

General Description

The MAX1393/MAX1396 micropower, serial-output, 12-bit, analog-to-digital converters (ADCs) operate with a single power supply from +1.5V to +3.6V. These ADCs feature automatic shutdown, fast wake-up, and a high-speed 3-wire interface. Power consumption is only 0.734mW ($V_{DD} = +1.5V$) at the maximum conversion rate of 312.5ksps. AutoShutdown™ between conversions reduces power consumption at slower throughput rates.

The MAX1393/MAX1396 require an external reference V_{REF} that has a wide range from 0.6V to V_{DD} . The MAX1393 provides one true-differential analog input that accepts signals ranging from 0 to V_{REF} (unipolar mode) or $\pm V_{REF}/2$ (bipolar mode). The MAX1396 provides two single-ended inputs that accept signals ranging from 0 to V_{REF} . Analog conversion results are available through a 5MHz 3-wire SPI™-/QSPI™-/MICROWIRE™-/digital signal processor (DSP)-compatible serial interface. Excellent dynamic performance, low voltage, low power, ease of use, and small package sizes make these converters ideal for portable battery-powered data-acquisition applications, and for other applications that demand low power consumption and minimal space.

The MAX1393/MAX1396 are available in a space-saving (3mm x 3mm) 10-pin TDFN package. The parts operate over the extended (-40°C to +85°C) and military (-55°C to +125°C) temperature ranges.

Applications

Portable Datalogging
Data Acquisition
Medical Instruments
Battery-Powered Instruments
Process Control

Features

- ◆ 312.5ksps, 12-Bit Successive-Approximation Register (SAR) ADCs
- ◆ Single True-Differential Analog Input Channel with Unipolar-/Bipolar-Select Input (MAX1393)
- ◆ Dual Single-Ended Input Channel with Channel-Select Input (MAX1396)
- ◆ ± 1 LSB INL, ± 1 LSB DNL, No Missing Codes
- ◆ ± 2 LSB Total Unadjusted Error (TUE)
- ◆ 70dB SINAD at 75kHz Input Frequency
- ◆ External Reference (0.6V to V_{DD})
- ◆ Single-Supply Voltage (+1.5V to +3.6V)
- ◆ 0.915mW at 300ksps, 1.8V
- ◆ 0.305mW at 100ksps, 1.8V
- ◆ 3.1 μ W at 1ksps, 1.8V
- ◆ < 1 μ A Shutdown Current
- ◆ AutoShutdown Between Conversions
- ◆ SPI-/QSPI-/MICROWIRE-/DSP-Compatible, 3- or 4-Wire Serial Interface
- ◆ Small (3mm x 3mm) 10-Pin TDFN Package

Typical Operating Circuit and Pin Configurations appear at end of data sheet.

AutoShutdown is a trademark of Maxim Integrated Products, Inc.
SPI/QSPI are trademarks of Motorola, Inc.
MICROWIRE is a trademark of National Semiconductor Corp.

Ordering Information

PART	TEMP RANGE	PIN-PACKAGE	ANALOG INPUTS	TOP MARK	PKG CODE
MAX1393ETB	-40°C to +85°C	10 TDFN-EP**	1-CH DIFF	AOZ	T1033-1
MAX1393MTB*	-55°C to +125°C	10 TDFN-EP**	1-CH DIFF	—	T1033-1
MAX1396ETB	-40°C to +85°C	10 TDFN-EP**	2-CH S/E	APC	T1033-1
MAX1396MTB*	-55°C to +125°C	10 TDFN-EP**	2-CH S/E	—	T1033-1

*Future product—contact factory for availability.

**EP = Exposed pad.

1.5V to 3.6V, 312.5ksps, 1-Channel True-Differential/ 2-Channel Single-Ended, 12-Bit, SAR ADCs

ABSOLUTE MAXIMUM RATINGS

V_{DD} to GND-0.3V to +4V
 SCLK, CS, OE, CH1/CH2, UNI/BIP,
 DOUT to GND.....-0.3V to (V_{DD} + 0.3V)
 AIN+, AIN-, AIN1, AIN2, REF to GND-0.3V to (V_{DD} + 0.3V)
 Maximum Current into Any Pin±50mA
 Continuous Power Dissipation (T_A = +70°C)
 10-Pin TDFN (derate 18.5mW/°C above +70°C) 1481.5mW

Operating Temperature Ranges

MAX139_E_-40°C to +85°C
 MAX139_M_-55°C to +125°C
 Junction Temperature+150°C
 Storage Temperature Range-60°C to +150°C
 Lead Temperature (soldering, 10s)+300°C

Stresses beyond those listed under "Absolute Maximum Ratings" may cause permanent damage to the device. These are stress ratings only, and functional operation of the device at these or any other conditions beyond those indicated in the operational sections of the specifications is not implied. Exposure to absolute maximum rating conditions for extended periods may affect device reliability.

ELECTRICAL CHARACTERISTICS

(V_{DD} = +1.5V to +3.6V, V_{REF} = V_{DD}, C_{REF} = 0.1μF, f_{SCLK} = 5MHz, T_A = T_{MIN} to T_{MAX}, unless otherwise noted. Typical values are at T_A = +25°C.)

PARAMETER	SYMBOL	CONDITIONS	MIN	TYP	MAX	UNITS
DC ACCURACY (Note 1)						
Resolution			12			Bits
Integral Nonlinearity	INL				±1	LSB
Differential Nonlinearity	DNL	No missing code overtemperature			±1	LSB
Offset Error				0.5	±2	LSB
Gain Error		Offset nulled		0.5	±2	LSB
Total Unadjusted Error	TUE				±2	LSB
Offset-Error Temperature Coefficient				±0.004		LSB/°C
Gain-Error Temperature Coefficient				±0.001		LSB/°C
Channel-to-Channel Offset Matching		MAX1396 only		±0.1		LSB
Channel-to-Channel Gain Matching		MAX1396 only		±0.1		LSB
Input Common-Mode Rejection	CMR	V _{CM} = 0 to V _{DD} , MAX1393 only		±0.1		mV/V
DYNAMIC SPECIFICATIONS (Note 2)						
Signal-to-Noise Plus Distortion	SINAD	V _{REF} = V _{DD} = 1.6		70		dB
		V _{REF} = V _{DD} = 1.8–2.5	69			
		V _{REF} = V _{DD} = 2.5–3.6	70			
Signal-to-Noise Ratio	SNR	V _{REF} = V _{DD} = 1.6		70.5		dB
		V _{REF} = V _{DD} = 1.8–2.5	70	71		
		V _{REF} = V _{DD} = 2.5–3.6	71			
Total Harmonic Distortion	THD			-83	-75	dBc
Spurious-Free Dynamic Range	SFDR			-85	-76	dBc
Intermodulation Distortion	IMD	f _{IN1} = 73kHz at -6.5dBFS, f _{IN2} = 77kHz at -6.5dBFS		-78		dB
Channel-to-Channel Crosstalk		MAX1396 only		-70		dB

1.5V to 3.6V, 312.5ksps, 1-Channel True-Differential/ 2-Channel Single-Ended, 12-Bit, SAR ADCs

MAX1393/MAX1396

ELECTRICAL CHARACTERISTICS (continued)

(V_{DD} = +1.5V to +3.6V, V_{REF} = V_{DD}, C_{REF} = 0.1μF, f_{SCLK} = 5MHz, T_A = T_{MIN} to T_{MAX}, unless otherwise noted. Typical values are at T_A = +25°C.)

PARAMETER	SYMBOL	CONDITIONS	MIN	TYP	MAX	UNITS
Full-Power Bandwidth		-3dB point		4		MHz
Full-Linear Bandwidth		SINAD > 68dB	MAX1393	200		kHz
			MAX1396	150		
CONVERSION RATE						
Conversion Time	t _{CONV}	13 clock cycles	2.6			μs
Throughput Rate		16 clock cycles per conversion; includes power-up, acquisition, and conversion time		312.5		ksps
Power-Up and Acquisition Time	t _{ACQ}	Three SCLK cycles	600			ns
Aperture Delay	t _{AD}			8		ns
Aperture Jitter	t _{AJ}			30		ps
Serial Clock Frequency	f _{CLK}		0.1		5.0	MHz
ANALOG INPUTS (AIN+, AIN-, AIN1, AIN2)						
Input Voltage Range	V _{IN}	Unipolar	0		V _{REF}	V
		Bipolar, MAX1393 only, (AIN+ - AIN-)	-V _{REF} /2		+V _{REF} /2	
Common-Mode Input Voltage Range	V _{CM}	Bipolar, MAX1393 only, [(AIN+) + (AIN-)] / 2	0		V _{DD}	V
Input Leakage Current		Channel not selected, or conversion stopped, or in shutdown mode			±1	μA
Input Capacitance				16		pF
REFERENCE INPUT (REF)						
REF Input Voltage Range	V _{REF}		0.6		V _{DD} + 0.05	V
REF Input Capacitance				24		pF
REF DC Leakage Current				0.025	±2.5	μA
REF Input Dynamic Current		312.5ksps		20	60	μA
DIGITAL INPUTS (SCLK, CS, OE, CH1/CH2, UNI/BIP)						
Input-Voltage Low	V _{IL}				0.3 x V _{DD}	V
Input-Voltage High	V _{IH}		0.7 x V _{DD}			V
Input Hysteresis				0.06 x V _{DD}		V
Input Leakage Current	I _{IL}	Inputs at GND or V _{DD}			±1	μA
Input Capacitance	C _{IN}	CS, OE		1		pF
		CH1/CH2, UNI/BIP		12.5		
DIGITAL OUTPUT (DOUT)						
Output-Voltage Low	V _{OL}	I _{SINK} = 2mA			0.1 x V _{DD}	V
Output-Voltage High	V _{OH}	I _{SOURCE} = 2mA	0.9 x V _{DD}			V

1.5V to 3.6V, 312.5ksps, 1-Channel True-Differential/ 2-Channel Single-Ended, 12-Bit, SAR ADCs

ELECTRICAL CHARACTERISTICS (continued)

($V_{DD} = +1.5V$ to $+3.6V$, $V_{REF} = V_{DD}$, $C_{REF} = 0.1\mu F$, $f_{SCLK} = 5MHz$, $T_A = T_{MIN}$ to T_{MAX} , unless otherwise noted. Typical values are at $T_A = +25^\circ C$.)

PARAMETER	SYMBOL	CONDITIONS	MIN	TYP	MAX	UNITS
Tri-State Leakage Current	I_{LT}	$\overline{OE} = V_{DD}$			± 1	μA
Tri-State Output Capacitance	C_{OUT}	$\overline{OE} = V_{DD}$		10		pF
POWER SUPPLY						
Positive Supply Voltage	V_{DD}		1.5		3.6	V
Positive Supply Current (Note 3)	I_{DD}	$f_{SAMPLE} = 100ksps$	$V_{DD} = 1.6V$	176	200	μA
			$V_{DD} = 3V$	225	260	
		$f_{SAMPLE} = 312.5ksps$	$V_{DD} = 1.6V$	520	600	
			$V_{DD} = 3V$	710	800	
		Power-down mode (Note 4)		5	10	
Power-down mode (Note 5)		0.2	± 2.5			
Power-Supply Rejection	PSR	$V_{DD} = 1.5V$ to $3.6V$, full-scale input (Note 6)		± 150	± 1000	$\mu V/V$

TIMING CHARACTERISTICS

($V_{DD} = +1.5V$ to $+3.6V$, $V_{REF} = V_{DD}$, $C_{REF} = 0.1\mu F$, $f_{SCLK} = 5MHz$, $T_A = T_{MIN}$ to T_{MAX} , unless otherwise noted. Typical values are at $T_A = +25^\circ C$.) (Figure 1)

PARAMETER	SYMBOL	CONDITIONS	MIN	TYP	MAX	UNITS
SCLK Clock Period	t_{CP}		200		10,000	ns
SCLK Pulse-Width High	t_{CH}		90			ns
SCLK Pulse-Width Low	t_{CL}		90			ns
\overline{CS} Fall to SCLK Rise Setup	t_{CSS}		80			ns
SCLK Rise to \overline{CS} Fall Ignore	t_{CSO}		0			ns
SCLK Fall to DOUT Valid	t_{DOV}	$C_{LOAD} = 0$ to $30pF$	10		80	ns
\overline{OE} Rise to DOUT Disable	t_{DOD}			6	20	ns
\overline{OE} Fall to DOUT Enable	t_{DOE}			9	20	ns
\overline{CS} Pulse-Width High or Low	t_{CSW}		80			ns
\overline{OE} Pulse-Width High or Low	$t_{OE W}$		80			ns
$\overline{CH1}/CH2$ Setup Time (to the First SCLK)	t_{CHS}	MAX1396 only	10			ns
$\overline{CH1}/CH2$ Hold Time (to the First SCLK)	t_{CHH}	MAX1396 only	0			ns
UNI/ \overline{BIP} Setup Time (to the First SCLK)	t_{UBS}	MAX1393 only	10			ns
UNI/ \overline{BIP} Hold Time (to the First SCLK)	t_{UBH}	MAX1393 only	0			ns

Note 1: $V_{DD} = 1.5V$, $V_{REF} = 1.5V$, and $V_{AIN} = 1.5V$.

Note 2: $V_{DD} = 1.5V$, $V_{REF} = 1.5V$, $V_{AIN} = 1.5V_{P-P}$, $f_{SCLK} = 5MHz$, $f_{SAMPLE} = 312.5ksps$, and f_{IN} (sine wave) = $75kHz$.

Note 3: All digital inputs swing between V_{DD} and GND. $V_{REF} = V_{DD}$, $f_{IN} = 75kHz$ sine wave, $V_{AIN} = V_{REF_{P-P}}$, $C_{LOAD} = 30pF$ on DOUT.

Note 4: $\overline{CS} = V_{DD}$, $\overline{OE} = UNI/\overline{BIP} = \overline{CH1}/CH2 = V_{DD}$ or GND, SCLK is active.

Note 5: $\overline{CS} = V_{DD}$, $\overline{OE} = UNI/\overline{BIP} = \overline{CH1}/CH2 = V_{DD}$ or GND, SCLK is inactive.

Note 6: Change in V_{AIN} at code boundary 4094.5.

1.5V to 3.6V, 312.5ksp/s, 1-Channel True-Differential/ 2-Channel Single-Ended, 12-Bit, SAR ADCs

MAX1393/MAX1396

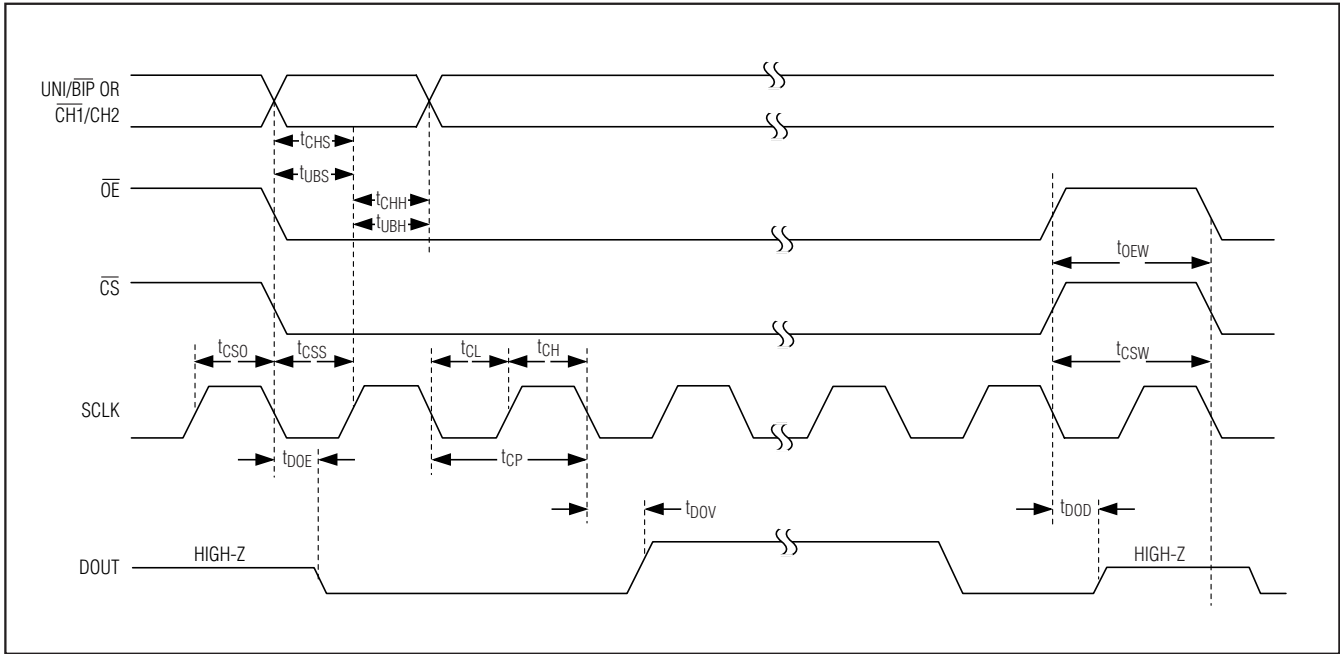

Figure 1. Detailed Serial-Interface Timing Diagram

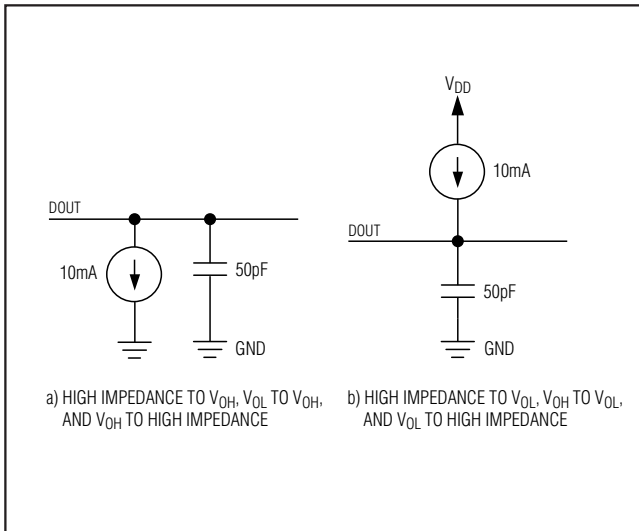
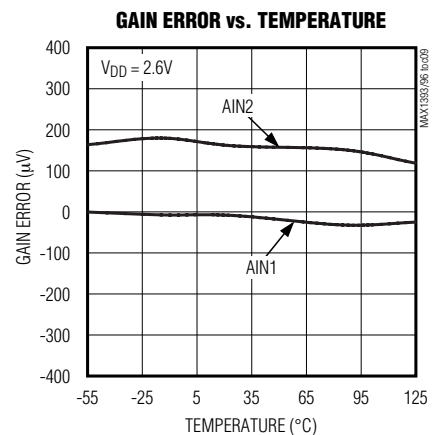
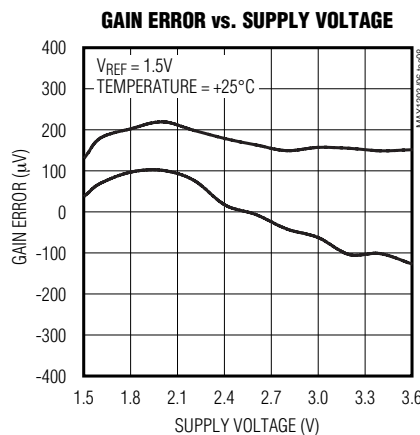
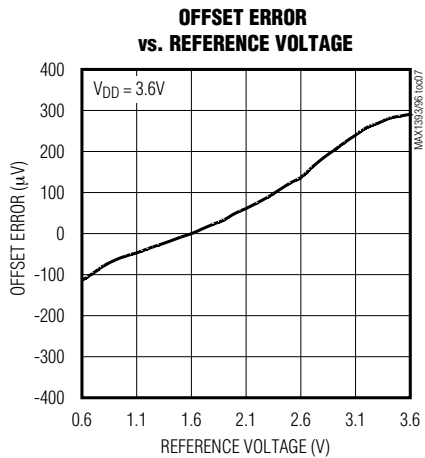
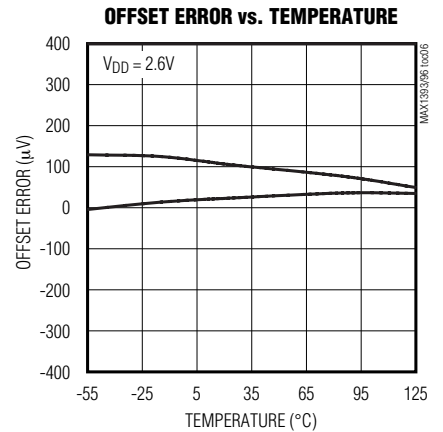
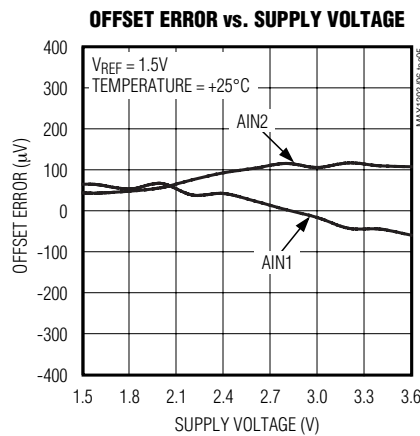
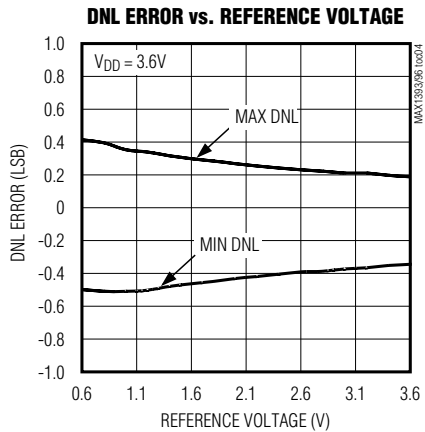
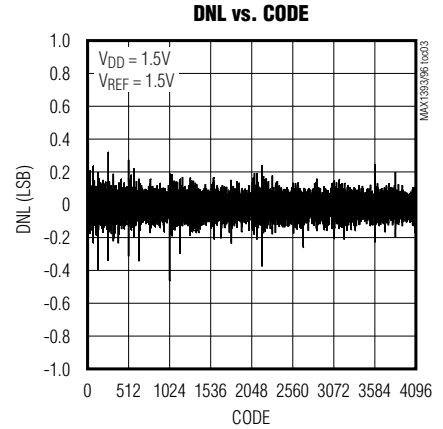
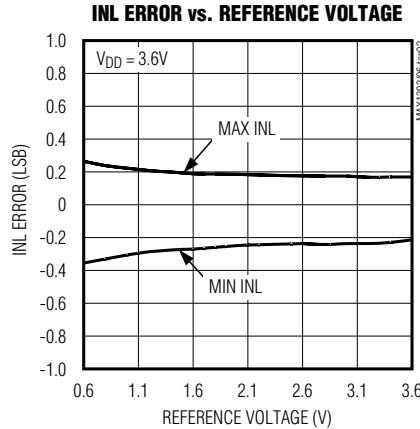
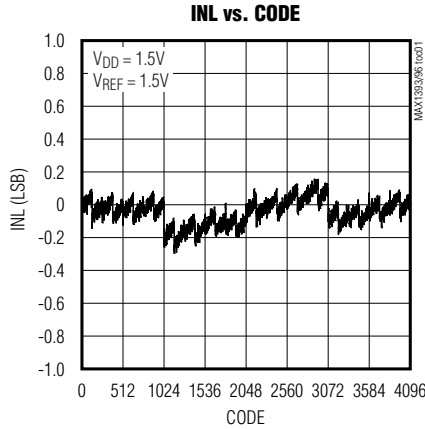

Figure 2. Load Circuits for Enable/Disable Times

1.5V to 3.6V, 312.5ksp/s, 1-Channel True-Differential/ 2-Channel Single-Ended, 12-Bit, SAR ADCs

Typical Operating Characteristics

($V_{DD} = +1.5V$, $V_{REF} = +1.5V$, $C_{REF} = 0.1\mu F$, $C_L = 30pF$, $f_{SCLK} = 5MHz$, $T_A = +25^\circ C$, unless otherwise noted.)



1.5V to 3.6V, 312.5ksps, 1-Channel True-Differential/ 2-Channel Single-Ended, 12-Bit, SAR ADCs

Typical Operating Characteristics (continued)

($V_{DD} = +1.5V$, $V_{REF} = +1.5V$, $C_{REF} = 0.1\mu F$, $C_L = 30pF$, $f_{SCLK} = 5MHz$, $T_A = +25^\circ C$, unless otherwise noted.)

MAX1393/MAX1396

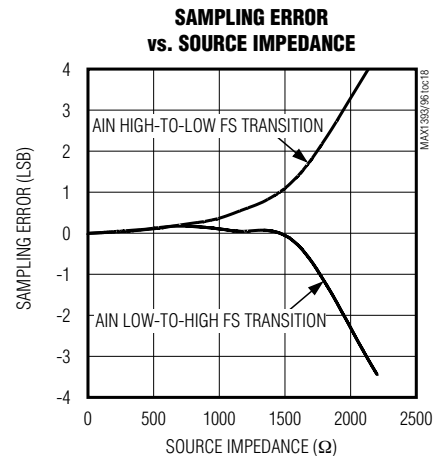
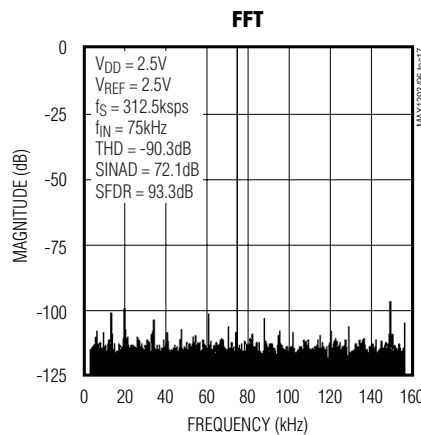
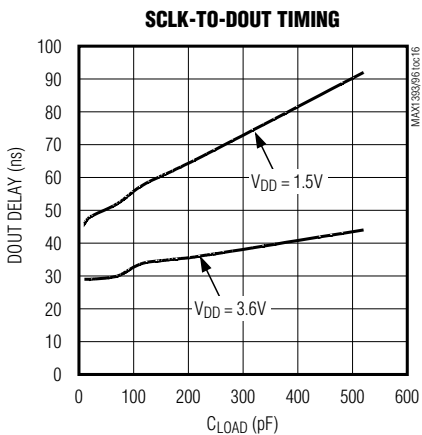
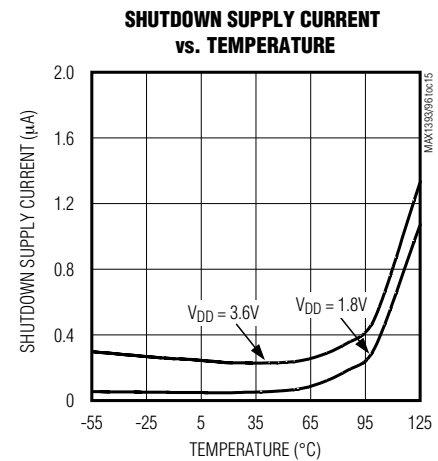
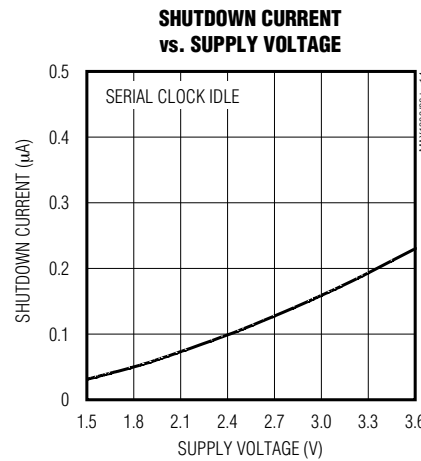
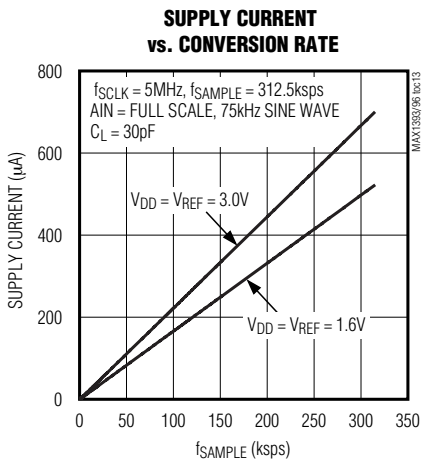
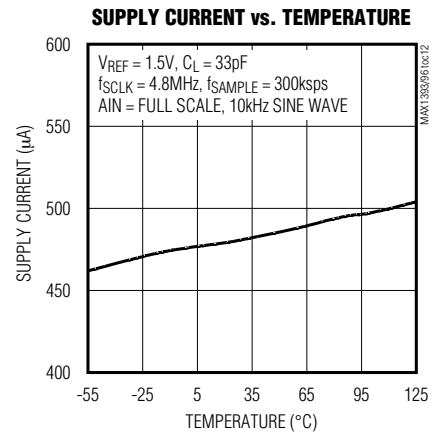
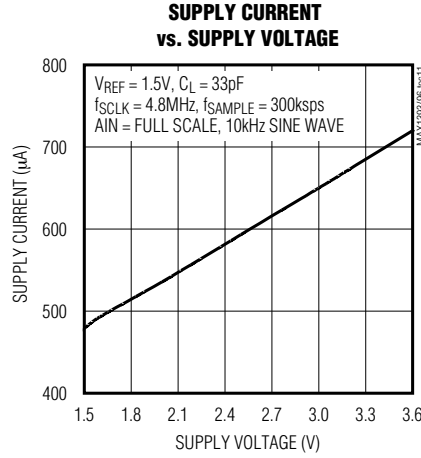
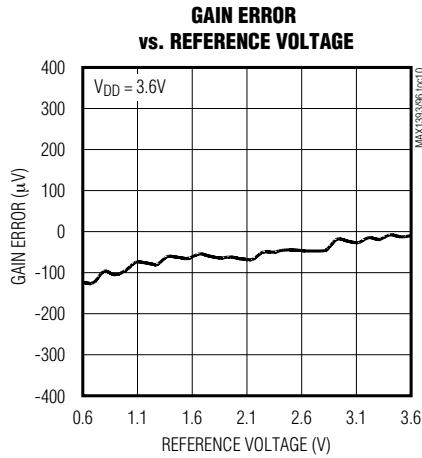

1.5V to 3.6V, 312.5ksps, 1-Channel True-Differential/ 2-Channel Single-Ended, 12-Bit, SAR ADCs

Pin Description

PIN		NAME	FUNCTION
MAX1393	MAX1396		
1	1	V _{DD}	Positive Supply Voltage. Connect V _{DD} to a 1.5V to 3.6V power supply. Bypass V _{DD} to GND with a 0.1μF capacitor as close to the device as possible.
2	—	AIN-	Negative Analog Input
—	2	AIN2	Analog Input Channel 2
3	—	AIN+	Positive Analog Input
—	3	AIN1	Analog Input Channel 1
4	4	GND	Ground
5	5	REF	External Reference Voltage Input. V _{REF} = 0.6V to (V _{DD} + 0.05V). Bypass REF to GND with a 0.1μF capacitor as close to the device as possible.
6	—	UNI/ $\overline{\text{BIP}}$	Input-Mode Select. Drive UNI/ $\overline{\text{BIP}}$ high to select unipolar input mode. Pull UNI/ $\overline{\text{BIP}}$ low to select bipolar input mode. In unipolar mode, the output data is in straight binary format. In bipolar mode, the output data is in two's complement format.
—	6	$\overline{\text{CH1/CH2}}$	Channel-Select Input. Pull $\overline{\text{CH1/CH2}}$ low to select channel 1. Drive $\overline{\text{CH1/CH2}}$ high to select channel 2.
7	7	$\overline{\text{OE}}$	Active-Low Output Enable. Pull $\overline{\text{OE}}$ low to enable DOUT. Drive $\overline{\text{OE}}$ high to disable DOUT. Connect to $\overline{\text{CS}}$ to interface with SPI, QSPI, and MICROWIRE devices or set low to interface with DSP devices.
8	8	$\overline{\text{CS}}$	Active-Low Chip-Select Input. A falling edge on $\overline{\text{CS}}$ initiates power-up and acquisition.
9	9	DOUT	Serial-Data Output. DOUT changes state on the falling edge of SCLK. DOUT is high impedance when $\overline{\text{OE}}$ is high.
10	10	SCLK	Serial-Clock Input. SCLK drives the conversion process and clocks data out. Acquisition ends on the 3rd falling edge after the $\overline{\text{CS}}$ falling edge. The LSB is clocked out on the SCLK 15th falling edge and the device enters AutoShutdown mode (see Figures 8, 9, and 10).
—	—	EP	Exposed Pad. Not internally connected. Connect the exposed pad to GND or leave floating.

Detailed Description

The MAX1393/MAX1396 use an input track and hold (T/H) circuit along with a SAR to convert an analog input signal to a serial 12-bit digital output data stream. The serial interface provides easy interfacing to microprocessors and DSPs. Figure 3 shows the simplified functional diagram for the MAX1393 (1 channel, true differential) and the MAX1396 (2 channels, single ended).

True-Differential Analog Input T/H

The equivalent input circuit of Figure 4 shows the MAX1393/MAX1396 input architecture, which is composed of a T/H, a comparator, and a switched-capacitor DAC. The T/H enters its tracking mode on the falling edge of $\overline{\text{CS}}$ (while $\overline{\text{OE}}$ is held low). The positive input capacitor is connected to AIN+ (MAX1393), or to AIN1 or AIN2 (MAX1396). The negative input capacitor is connected to AIN- (MAX1393) or GND (MAX1396). The T/H enters its hold mode on the 3rd falling edge of SCLK

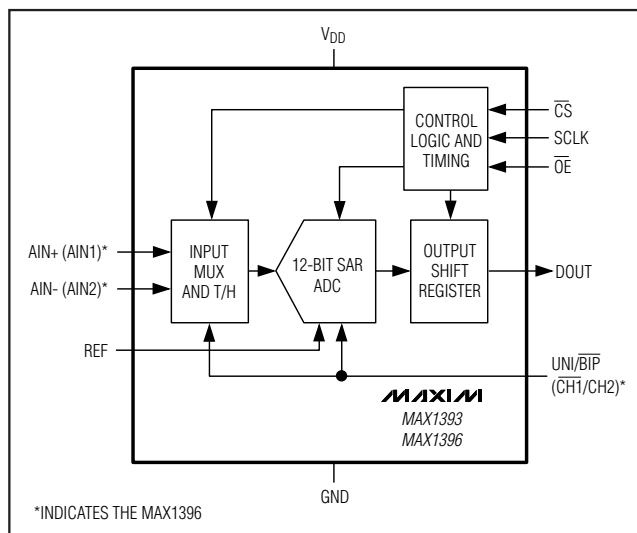

Figure 3. Simplified Functional Diagram

1.5V to 3.6V, 312.5ksps, 1-Channel True-Differential/ 2-Channel Single-Ended, 12-Bit, SAR ADCs

and the difference between the sampled positive and negative input voltages is converted. The time required for the T/H to acquire an input signal is determined by how quickly its input capacitance is charged. The required acquisition time lengthens as the input signal's source impedance increases. The acquisition time, t_{ACQ} , is the minimum time needed for the signal to be acquired. It is calculated by the following equation:

$$t_{ACQ} \geq 9 \times (R_{SOURCE} + R_{IN}) \times C_{IN} + t_{PU}$$

where:

R_{SOURCE} is the source impedance of the input signal.

$R_{IN} = 500\Omega$, which is the equivalent differential analog input resistance.

$C_{IN} = 16\text{pF}$, which is the equivalent differential analog input capacitance.

$t_{PU} = 400\text{ns}$.

Note: t_{ACQ} is never less than 600ns and any source impedance below 400Ω does not significantly affect the ADC's AC performance.

Analog Input Bandwidth

The ADC's input-tracking circuitry has a 4MHz full-power bandwidth, making it possible to digitize high-speed transient events and measure periodic signals with bandwidths exceeding the ADC's sampling rate by using undersampling techniques.

Use anti-alias filtering to avoid high-frequency signals being aliased into the frequency band of interest.

Analog Input Range and Protection

The MAX1393/MAX1396 produce a digital output that corresponds to the analog input voltage as long as the analog inputs are within their specified range. When operating the MAX1393 in unipolar mode ($UNI/BIP = 1$), the specified differential analog input range is from 0 to V_{REF} . When operating in bipolar mode ($UNI/BIP = 0$), the differential analog input range is from $-V_{REF}/2$ to $+V_{REF}/2$ with a common-mode range of 0 to V_{DD} . The MAX1396 has an input range from 0 to V_{REF} .

Internal protection diodes confine the analog input voltage within the region of the analog power input rails (V_{DD} , GND) and allow the analog input voltage to swing from $GND - 0.3V$ to $V_{DD} + 0.3V$ without damage. Input voltages beyond $GND - 0.3V$ and $V_{DD} + 0.3V$ forward bias the internal protection diodes. In this situation, limit the forward diode current to less than 50mA to avoid damage to the MAX1393/MAX1396.

Output Data Format

Figures 8, 9, and 10 illustrate the conversion timing for the MAX1393/MAX1396. Sixteen SCLK cycles are required to read the conversion result and data on DOUT transitions on the falling edge of SCLK. The conversion result contains 4 zeros, followed by 12 data bits with the data in MSB-first format. For the MAX1393, data is straight binary for unipolar mode and two's complement for bipolar mode. For the MAX1396, data is always straight binary.

Transfer Function

Figure 5 shows the unipolar transfer function for the MAX1393/MAX1396. Figure 6 shows the bipolar transfer function for the MAX1393. Code transitions occur halfway between successive-integer LSB values.

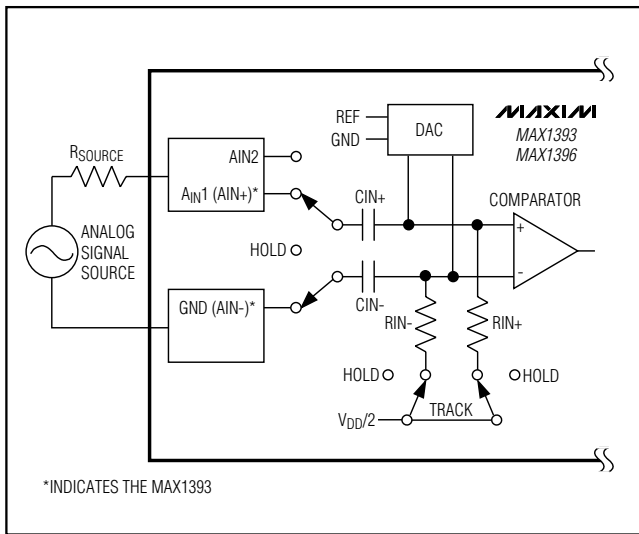

Figure 4. Equivalent Input Circuit

1.5V to 3.6V, 312.5ksp/s, 1-Channel True-Differential/ 2-Channel Single-Ended, 12-Bit, SAR ADCs

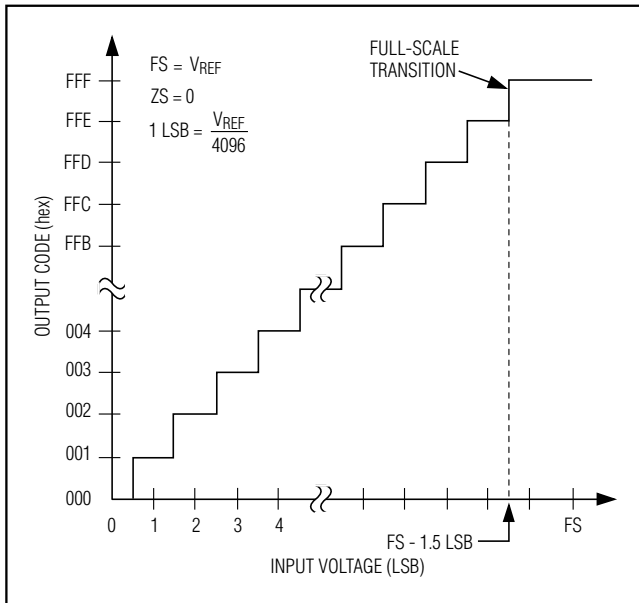

Figure 5. Unipolar Transfer Function

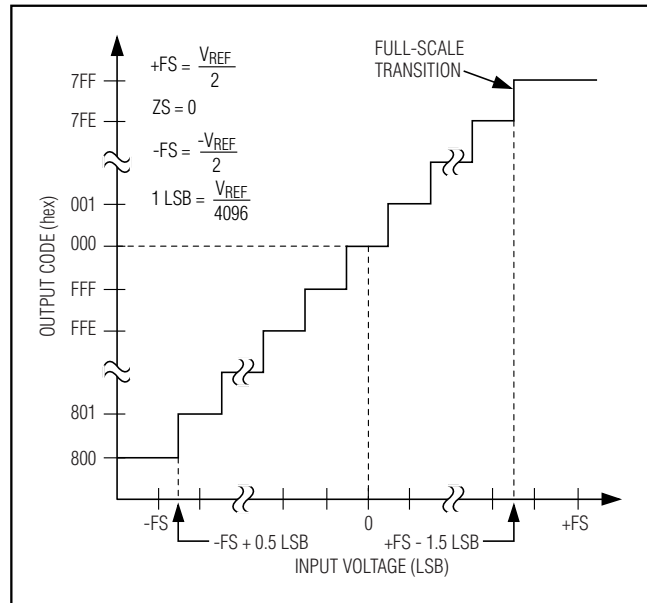

Figure 6. Bipolar Transfer Function

Applications Information

Starting a Conversion

A falling edge on \overline{CS} initiates the power-up sequence and begins acquiring the analog input as long as \overline{OE} is also asserted low. On the 3rd SCLK falling edge, the analog input is held for conversion. The most significant bit (MSB) decision is made and clocked onto DOUT on the 4th SCLK falling edge. Valid DOUT data is available to be clocked into the master (microcontroller (μC)) on the following SCLK rising edge. The rest of the bits are decided and clocked out to DOUT on each successive SCLK falling edge. See Figures 8 and 9 for conversion timing diagrams.

Once a conversion has been initiated, \overline{CS} can go high at any time. Further falling edges of \overline{CS} do not reinitiate an acquisition cycle until the current conversion completes. Once a conversion completes, the first falling edge of \overline{CS} begins another acquisition/conversion cycle.

Selecting Unipolar or Bipolar Mode (MAX1393 Only)

Drive $\overline{UNI/BIP}$ high to select unipolar mode or pull $\overline{UNI/BIP}$ low to select bipolar mode. $\overline{UNI/BIP}$ can be connected to V_{DD} for logic high, to GND for logic low, or actively driven. $\overline{UNI/BIP}$ needs to be stable for t_{UBS} prior to the first rising edge of SCLK after the \overline{CS} falling edge (see Figure 1) for a valid conversion result when being actively driven.

Selecting Analog Input AIN1 or AIN2 (MAX1396 Only)

Pull $\overline{CH1/CH2}$ low to select AIN1 or drive $\overline{CH1/CH2}$ high to select AIN2 for conversion. $\overline{CH1/CH2}$ can be connected to V_{DD} for logic high, to GND for logic low, or actively driven. $\overline{CH1/CH2}$ needs to be stable for t_{CHS} prior to the first rising edge of SCLK after the \overline{CS} falling edge (see Figure 1) for a valid conversion result when being actively driven.

1.5V to 3.6V, 312.5kps, 1-Channel True-Differential/ 2-Channel Single-Ended, 12-Bit, SAR ADCs

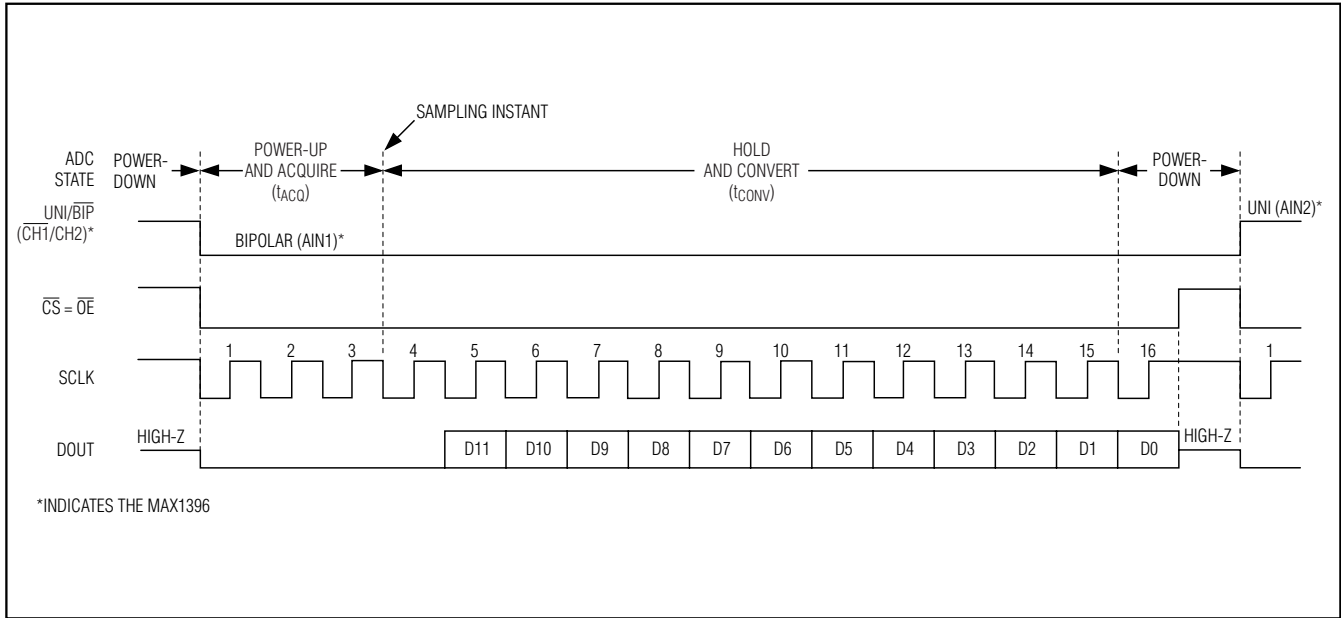

Figure 8. Serial-Interface Timing for SPI/QSPI (CPOL = CPHA = 1) and MICROWIRE (G6 = 0, G5 = 1)

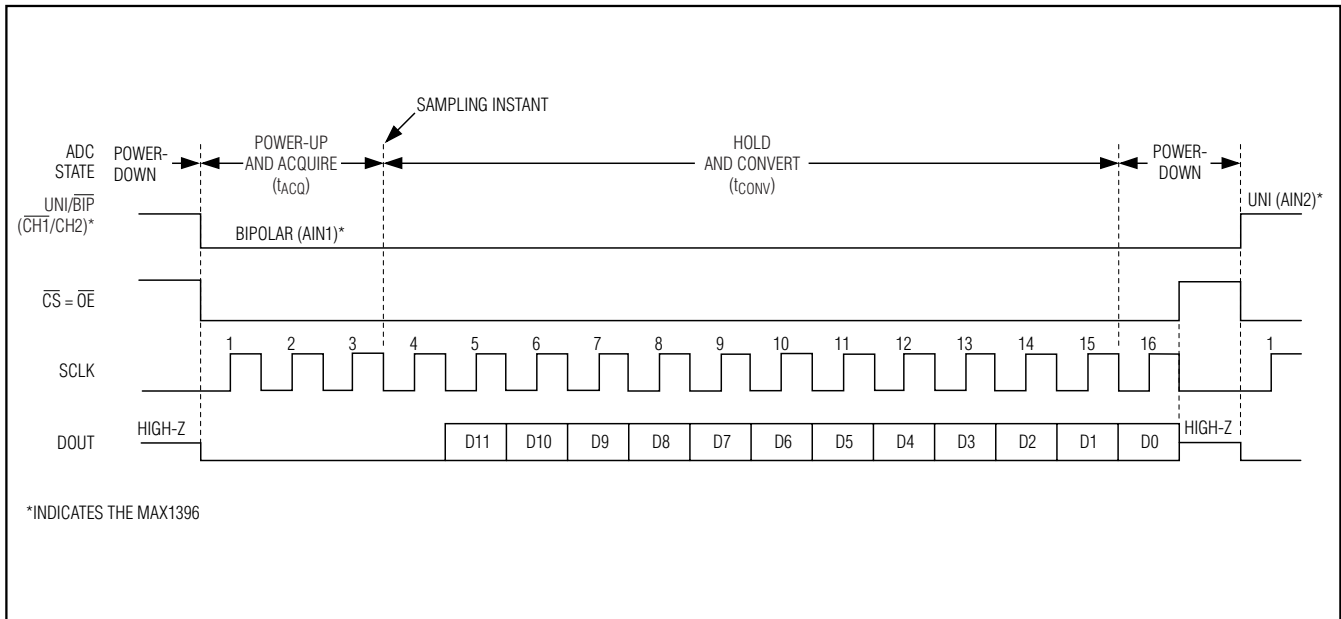

Figure 9. Serial-Interface Timing for SPI/QSPI (CPOL = CPHA = 0) and MICROWIRE (G6 = 0, G5 = 0)

1.5V to 3.6V, 312.5ksps, 1-Channel True-Differential/ 2-Channel Single-Ended, 12-Bit, SAR ADCs

MAX1393/MAX1396

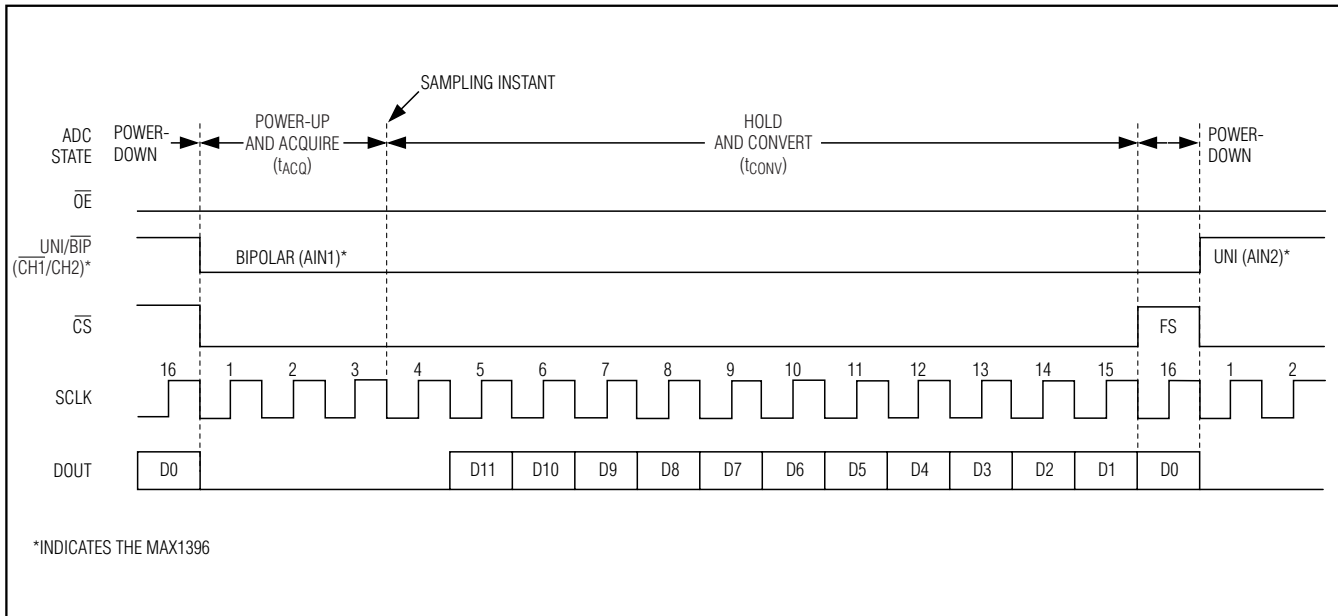

Figure 10. DSP Serial-Timing Diagram

As shown in Figure 11, drive the MAX1393/MAX1396 chip-select input (\overline{CS}) with the DSP's frame-sync signal. \overline{OE} may be connected to GND or driven independently. For continuous conversion operation, keep \overline{OE} low and make the \overline{CS} falling edge coincident with the 16th falling edge of the SCLK.

Unregulated Two-Cell or Single Lithium LiMnO₂ Cell Operation

Low operating voltage (1.5V to 3.6V) and ultra-low-power consumption make the MAX1393/MAX1396 ideal for low cost, unregulated, battery-powered applications without the need for a DC-DC converter. Power the MAX1393/MAX1396 directly from two alkaline/NiMH/NiCd cells in series or a single lithium coin cell as shown in the *Typical Operating Circuit*.

Fresh alkaline cells have a voltage of approximately 1.5V per cell (3V with 2 cells in series) and approach end of life at 0.8V (1.6V with 2 cells in series). A typical 2xAA alkaline discharge curve is shown in Figure 12a. A typical CR2032 lithium (LiMnO₂) coin cell discharge curve is shown in Figure 12b.

Layout, Grounding, and Bypassing

For best performance, use PC boards. Board layout must ensure that digital and analog signal lines are separated from each other. Do not run analog and digital (especially clock) lines parallel to one another, or digital lines underneath the ADC package.

Figure 13 shows the recommended system ground connections. Establish a single-point analog ground (star ground point) at the MAX1393/MAX1396s' GND pin or use the ground plane.

High-frequency noise in the power supply (V_{DD}) degrades the ADC's performance. Bypass V_{DD} to GND with a 0.1 μ F capacitor as close to the device as possible. Minimize capacitor lead lengths for best supply noise rejection. To reduce the effects of supply noise, a 10 Ω resistor can be connected as a lowpass filter to attenuate supply noise.

Exposed Pad

The MAX1393/MAX1396 TDFN package has an exposed pad on the bottom of the package. This pad is not internally connected. Connect the exposed pad to the GND pin on the MAX1393/MAX1396 or leave floating for proper electrical performance.

Definitions

Integral Nonlinearity (INL)

INL is the deviation of the values on an actual transfer function from a straight line. For the MAX1393/MAX1396, this straight line is between the end points of the transfer function once offset and gain errors have been nullified. INL deviations are measured at every step and the worst-case deviation is reported in the *Electrical Characteristics* section.

1.5V to 3.6V, 312.5ksps, 1-Channel True-Differential/ 2-Channel Single-Ended, 12-Bit, SAR ADCs

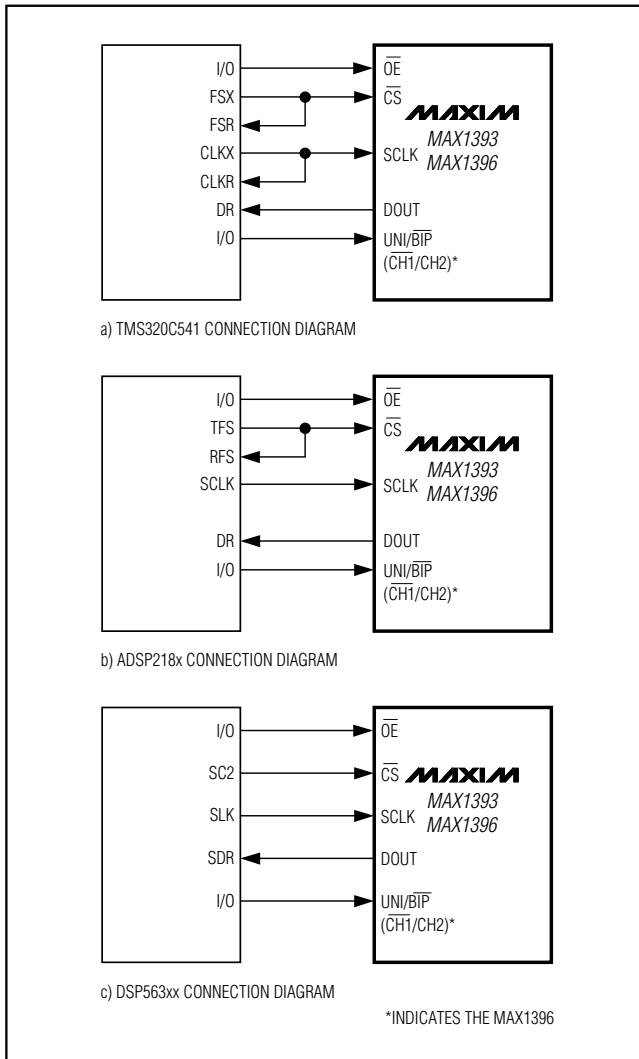

Figure 11. Common DSP Connections to the MAX1393/MAX1396

Differential Nonlinearity (DNL)

DNL is the difference between an actual step width and the ideal value of 1 LSB. A DNL error specification of less than ± 1 LSB guarantees no missing codes and a monotonic transfer function. For the MAX1393/MAX1396, DNL deviations are measured at every step and the worst-case deviation is reported in the *Electrical Characteristics* section.

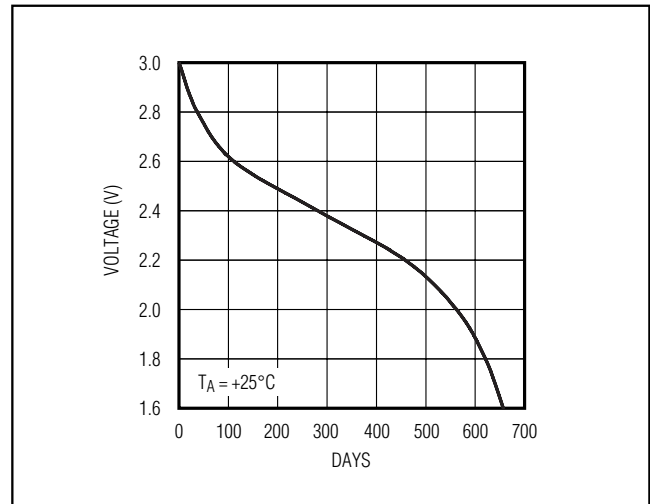

Figure 12a. Typical 2xAA Discharge Curve at 100ksps

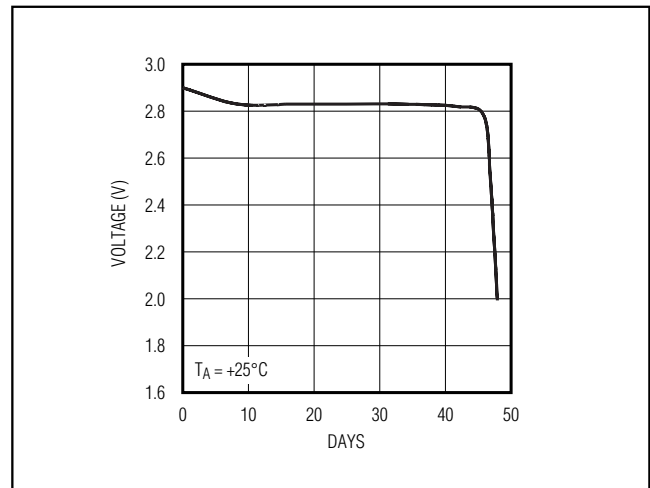

Figure 12b. Typical CR2032 Discharge Curve at 100ksps

Signal-to-Noise Plus Distortion (SINAD)

SINAD is computed by taking the ratio of the RMS signal to the RMS noise plus the RMS distortion. RMS noise includes all spectral components to the Nyquist frequency excluding the fundamental, the first five harmonics (HD2–HD6), and the DC offset. RMS distortion includes the first five harmonics (HD2–HD6):

$$\text{SINAD} = 20 \times \log \left(\frac{\text{SIGNAL}_{\text{RMS}}}{\sqrt{\text{NOISE}_{\text{RMS}}^2 + \text{DISTORTION}_{\text{RMS}}^2}} \right)$$

1.5V to 3.6V, 312.5ksps, 1-Channel True-Differential/ 2-Channel Single-Ended, 12-Bit, SAR ADCs

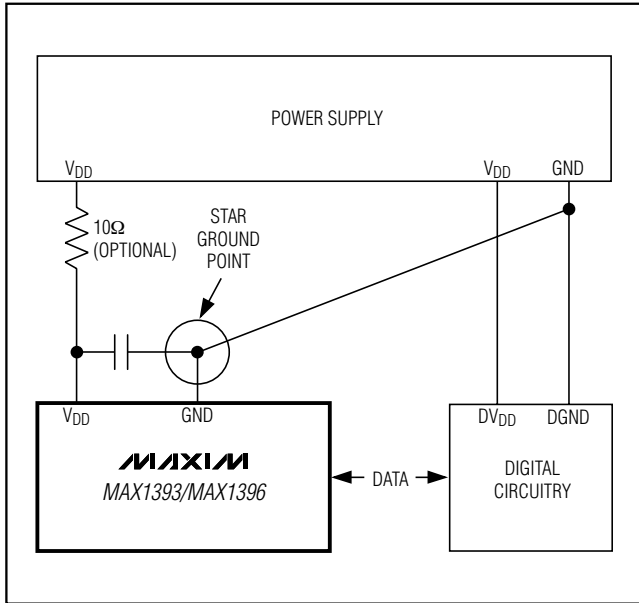

Figure 13. Power-Supply Grounding Connections

Signal-to-Noise Ratio (SNR)

SNR is a dynamic figure of merit that indicates the converter's noise performance. For a waveform perfectly reconstructed from digital samples, the theoretical maximum SNR is the ratio of the full-scale analog input (RMS value) to the RMS quantization error (residual error). The ideal, theoretical minimum analog-to-digital noise is caused by quantization error only and results directly from the ADC's resolution (N bits):

$$SNR_{dB[max]} = 6.02dB \times N + 1.76dB$$

In reality, there are other noise sources such as thermal noise, reference noise, and clock jitter that also degrade SNR. SNR is computed by taking the ratio of the RMS signal to the RMS noise. RMS noise includes all spectral components to the Nyquist frequency excluding the fundamental, the first five harmonics, and the DC offset.

Total Harmonic Distortion (THD)

THD is a dynamic figure of merit that indicates how much harmonic distortion the converter adds to the signal.

THD is the ratio of the RMS sum of the first five harmonics of the fundamental signal to the fundamental itself. This is expressed as:

$$THD = 20 \times \log \left(\frac{\sqrt{V_2^2 + V_3^2 + V_4^2 + V_5^2 + V_6^2}}{V_1} \right)$$

where V_1 is the fundamental amplitude, and V_2 through V_6 are the amplitudes of the 2nd- through 6th-order harmonics.

Spurious-Free Dynamic Range (SFDR)

SFDR is a dynamic figure of merit that indicates the lowest usable input signal amplitude. SFDR is the ratio of the RMS amplitude of the fundamental (maximum signal component) to the RMS value of the next-largest spurious component, excluding DC offset. SFDR is specified in decibels relative to the carrier (dBc).

Intermodulation Distortion (IMD)

IMD is the ratio of the RMS sum of the intermodulation products to the RMS sum of the two fundamental input tones. This is expressed as:

$$IMD = 20 \times \log \left(\frac{\sqrt{V_{IM1}^2 + V_{IM2}^2 + \dots + V_{IM3}^2 + V_{IMN}^2}}{\sqrt{V_1^2 + V_2^2}} \right)$$

The fundamental input tone amplitudes (V_1 and V_2) are at -6.5dBFS. Fourteen intermodulation products ($V_{IM_}$) are used in the MAX1393/MAX1396 IMD calculation. The intermodulation products are the amplitudes of the output spectrum at the following frequencies, where f_{IN1} and f_{IN2} are the fundamental input tone frequencies:

- 2nd-order intermodulation products:
 $f_{IN1} + f_{IN2}$, $f_{IN2} - f_{IN1}$
- 3rd-order intermodulation products:
 $2 \times f_{IN1} - f_{IN2}$, $2 \times f_{IN2} - f_{IN1}$, $2 \times f_{IN1} + f_{IN2}$, $2 \times f_{IN2} + f_{IN1}$
- 4th-order intermodulation products:
 $3 \times f_{IN1} - f_{IN2}$, $3 \times f_{IN2} - f_{IN1}$, $3 \times f_{IN1} + f_{IN2}$, $3 \times f_{IN2} + f_{IN1}$
- 5th-order intermodulation products:
 $3 \times f_{IN1} - 2 \times f_{IN2}$, $3 \times f_{IN2} - 2 \times f_{IN1}$, $3 \times f_{IN1} + 2 \times f_{IN2}$, $3 \times f_{IN2} + 2 \times f_{IN1}$

Channel-to-Channel Crosstalk

Channel-to-channel crosstalk indicates how well each analog input is isolated from the others. The channel-to-channel crosstalk for the MAX1396 is measured by applying DC to channel 2 while an AC sine wave is applied to channel 1. An FFT is taken for channel 1 and channel 2 and the difference (in dB) is reported as the channel-to-channel crosstalk.

1.5V to 3.6V, 312.5ksp/s, 1-Channel True-Differential/ 2-Channel Single-Ended, 12-Bit, SAR ADCs

Aperture Delay

The MAX1393/MAX1396 sample data on the falling edge of its third SCLK cycle (Figure 14). In actuality, there is a small delay between the falling edge of the sampling clock and the actual sampling instant. Aperture delay (t_{AD}) is the time defined between the falling edge of the sampling clock and the instant when an actual sample is taken.

Aperture Jitter

Aperture jitter (t_{AJ}) is the sample-to-sample variation in the aperture delay (Figure 14).

DC Power-Supply Rejection Ratio (PSRR)

DC PSRR is defined as the change in the positive full-scale transfer function point caused by a full range variation in the analog power-supply voltage (V_{DD}).

Chip Information

TRANSISTOR COUNT: 9106

PROCESS: BiCMOS

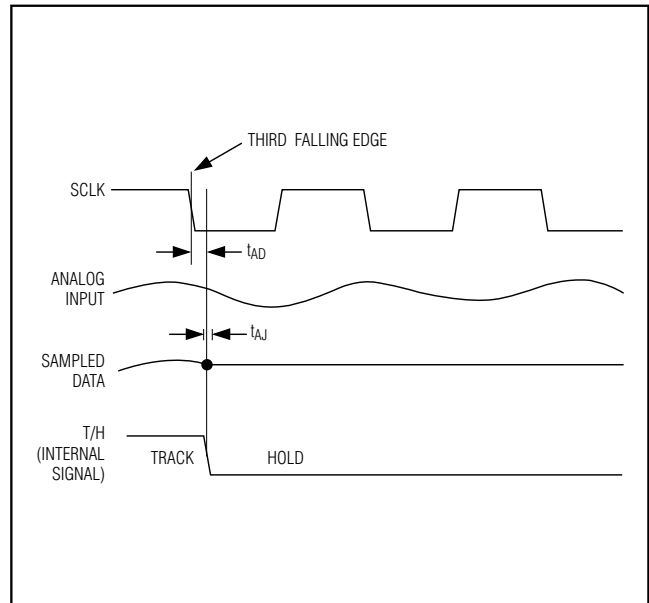
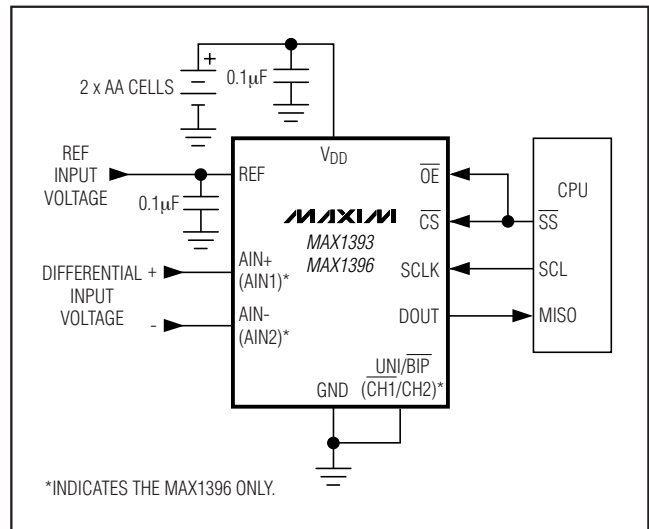

Figure 14. T/H Aperture Timing

Typical Operating Circuit



1.5V to 3.6V, 312.5ksp/s, 1-Channel True-Differential/ 2-Channel Single-Ended, 12-Bit, SAR ADCs

Pin Configurations

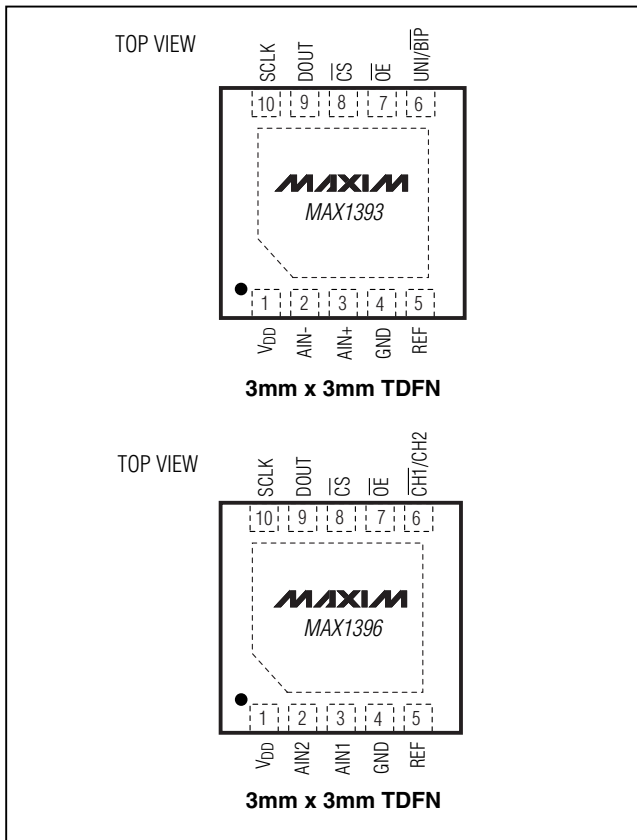

MAX1393/MAX1396

