



# 38V, Low-Noise, MOS-Input, Low-Power Op Amp

MAX9945

## General Description

The MAX9945 operational amplifier features an excellent combination of low operating power and low input voltage noise. In addition, MOS inputs enable the MAX9945 to feature low input bias currents and low input current noise. The device accepts a wide supply voltage range from 4.75V to 38V and draws a low 400 $\mu$ A quiescent current. The MAX9945 is unity-gain stable and is capable of rail-to-rail output voltage swing.

The MAX9945 is ideal for portable medical and industrial applications that require low noise analog front-ends for performance applications such as photodiode transimpedance and chemical sensor interface circuits.

The MAX9945 is available in both an 8-pin  $\mu$ MAX<sup>®</sup> and a space-saving, 6-pin TDFN package, and is specified over the automotive operating temperature range (-40°C to +125°C).

## Applications

Medical Pulse Oximetry  
 Photodiode Sensor Interface  
 Industrial Sensors and Instrumentation  
 Chemical Sensor Interface  
 High-Performance Audio Line Out  
 Active Filters and Signal Processing

$\mu$ MAX is a registered trademark of Maxim Integrated Products, Inc.

## Features

- ◆ +4.75V to +38V Single-Supply Voltage Range
- ◆  $\pm$ 2.4V to  $\pm$ 19V Dual-Supply Voltage Range
- ◆ Rail-to-Rail Output Voltage Swing
- ◆ 400 $\mu$ A Low Quiescent Current
- ◆ 50fA Low Input Bias Current
- ◆ 1fA/ $\sqrt{\text{Hz}}$  Low Input Current Noise
- ◆ 15nV/ $\sqrt{\text{Hz}}$  Low Noise
- ◆ 3MHz Unity-Gain Bandwidth
- ◆ Wide Temperature Range from -40°C to +125°C
- ◆ Available in Space-Saving, 6-Pin TDFN Package (3mm x 3mm)

## Ordering Information

| PART        | TEMP RANGE      | PIN-PACKAGE | TOP MARK |
|-------------|-----------------|-------------|----------|
| MAX9945ATT+ | -40°C to +125°C | 6 TDFN-EP*  | AUE      |
| MAX9945AUA+ | -40°C to +125°C | 8 $\mu$ MAX | —        |

+ Denotes a lead(Pb)-free/RoHS-compliant package.

\*EP = Exposed pad.

## Typical Operating Circuit

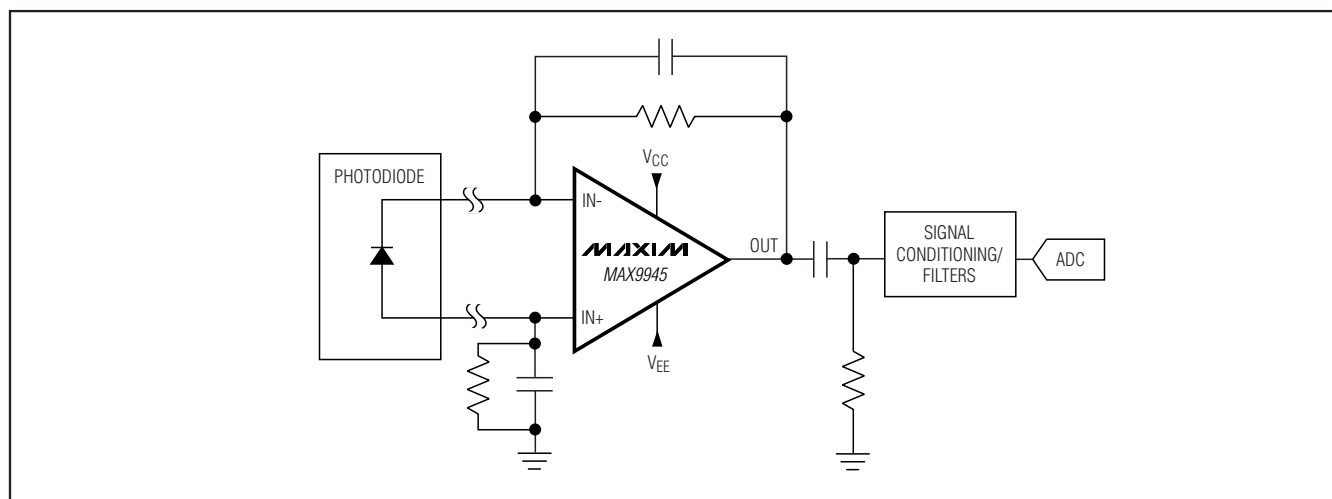

# 38V, Low-Noise, MOS-Input, Low-Power Op Amp

## ABSOLUTE MAXIMUM RATINGS

|   |  |
|---|--|
| Supply Voltage ( $V_{CC}$ to $V_{EE}$ )                         | -0.3V to +40V                              |
| IN+, IN-, OUT Voltage   | ( $V_{EE} - 0.3V$ ) to ( $V_{CC} + 0.3V$ ) |
| IN+ to IN-  | $\pm 12V$                                  |
| OUT Short Circuit to Ground Duration                            | 10s  |
| Continuous Input Current into Any Pin                           | $\pm 20mA$                                 |
| Continuous Power Dissipation ( $T_A = +70^\circ C$ )            |  |
| 6-Pin TDFN-EP (derate 23.8mW/ $^\circ C$ above +70 $^\circ C$ ) |  |
| Multilayer Board  | 1904.8mW                                   |
| Package Thermal Resistance (Note 1)                             |  |
| $\theta_{JA}$   | 42 $^\circ C/W$                            |
| $\theta_{JC}$   | 9 $^\circ C/W$                             |

|  |                                   |
|--|-----------------------------------|
| 8-Pin $\mu$ MAX (derate 4.8mW/ $^\circ C$ above +70 $^\circ C$ ) |                                   |
| Multilayer Board   | 387.8mW                           |
| Package Thermal Resistance (Note 1)                              |                                   |
| $\theta_{JA}$  | 206.3 $^\circ C/W$                |
| $\theta_{JC}$  | 42 $^\circ C/W$                   |
| Operating Temperature Range                                      | -40 $^\circ C$ to +125 $^\circ C$ |
| Junction Temperature   | +150 $^\circ C$                   |
| Storage Temperature Range  | -65 $^\circ C$ to +150 $^\circ C$ |
| Lead Temperature (soldering, 10s)                                | +300 $^\circ C$                   |

**Note 1:** Package thermal resistances were obtained using the method described in JEDEC specification JESD51-7, using a four-layer board. For detailed information on package thermal considerations, refer to [www.maxim-ic.com/thermal-tutorial](http://www.maxim-ic.com/thermal-tutorial).

Stresses beyond those listed under "Absolute Maximum Ratings" may cause permanent damage to the device. These are stress ratings only, and functional operation of the device at these or any other conditions beyond those indicated in the operational sections of the specifications is not implied. Exposure to absolute maximum rating conditions for extended periods may affect device reliability.

## ELECTRICAL CHARACTERISTICS

( $V_{CC} = +15V$ ,  $V_{EE} = -15V$ ,  $V_{IN+} = V_{IN-} = GND = 0$ ,  $R_{OUT} = 100k\Omega$  to GND,  $T_A = -40^\circ C$  to +125 $^\circ C$ , typical values are at  $T_A = +25^\circ C$ , unless otherwise noted.) (Note 2)

| PARAMETER                            | SYMBOL                | CONDITIONS  | MIN                          | TYP       | MAX            | UNITS            |
|--------------------------------------|-----------------------|---|------------------------------|-----------|----------------|------------------|
| <b>DC ELECTRICAL CHARACTERISTICS</b> |                       |   |                              |           |                |                  |
| Input Voltage Range                  | $V_{IN+}$ , $V_{IN-}$ | Guaranteed by CMRR  | $T_A = +25^\circ C$          | $V_{EE}$  | $V_{CC} - 1.2$ | V                |
|                                      |                       |   | $T_A = T_{MIN}$ to $T_{MAX}$ | $V_{EE}$  | $V_{CC} - 1.4$ |                  |
| Input Offset Voltage                 | $V_{OS}$              | $T_A = +25^\circ C$   |                              | $\pm 0.6$ | $\pm 5$        | mV               |
|                                      |                       | $T_A = T_{MIN}$ to $T_{MAX}$  |                              |           | $\pm 8$        |                  |
| Input Offset Voltage Drift           | $V_{OS} - T_C$        |   |                              | 2         |                | $\mu V/^\circ C$ |
| Input Bias Current (Note 3)          | $I_B$                 |   |                              | 50        |                | fA               |
| Common-Mode Rejection Ratio          | CMRR                  | $V_{CM} = V_{EE}$ to $V_{CC} - 1.2V$ ,<br>$T_A = +25^\circ C$                       | 78                           | 94        |                | dB               |
|                                      |                       | $V_{CM} = V_{EE}$ to $V_{CC} - 1.4V$ ,<br>$T_A = T_{MIN}$ to $T_{MAX}$              | 78                           | 94        |                |                  |
| Open-Loop Gain                       | $A_{OL}$              | $V_{EE} + 0.3V \leq V_{OUT} \leq V_{CC} - 0.3V$ ,<br>$R_{OUT} = 100k\Omega$ to GND  | 110                          | 130       |                | dB               |
|                                      |                       | $V_{EE} + 0.75V \leq V_{OUT} \leq V_{CC} - 0.75V$ ,<br>$R_{OUT} = 10k\Omega$ to GND | 110                          | 130       |                |                  |
| Output Short-Circuit Current         | $I_{SC}$              |   |                              | 25        |                | mA               |

# 38V, Low-Noise, MOS-Input, Low-Power Op Amp

MAX9945

## ELECTRICAL CHARACTERISTICS (continued)

( $V_{CC} = +15V$ ,  $V_{EE} = -15V$ ,  $V_{IN+} = V_{IN-} = GND = 0$ ,  $R_{OUT} = 100k\Omega$  to GND,  $T_A = -40^\circ C$  to  $+125^\circ C$ , typical values are at  $T_A = +25^\circ C$ , unless otherwise noted.) (Note 2)

| PARAMETER                                      | SYMBOL            | CONDITIONS   |                              | MIN             | TYP             | MAX             | UNITS          |
|--|-------------------|--|------------------------------|-----------------|-----------------|-----------------|----------------|
| Output Voltage Low                             | $V_{OL}$          | $R_{OUT} = 10k\Omega$ to GND   | $T_A = T_{MIN}$ to $T_{MAX}$ |                 | $V_{EE} + 0.26$ | $V_{EE} + 0.45$ | V              |
|  |                   | $R_{OUT} = 100k\Omega$ to GND  | $T_A = T_{MIN}$ to $T_{MAX}$ |                 | $V_{EE} + 0.05$ | $V_{EE} + 0.15$ |                |
| Output Voltage High                            | $V_{OH}$          | $R_{OUT} = 10k\Omega$ to GND   | $T_A = T_{MIN}$ to $T_{MAX}$ | $V_{CC} - 0.45$ | $V_{CC} - 0.24$ |                 | V              |
|  |                   | $R_{OUT} = 100k\Omega$ to GND  | $T_A = T_{MIN}$ to $T_{MAX}$ | $V_{CC} - 0.15$ | $V_{CC} - 0.03$ |                 |                |
| <b>AC ELECTRICAL CHARACTERISTICS</b>           |                   |  |                              |                 |                 |                 |                |
| Input Current-Noise Density                    | $I_N$             | $f = 1kHz$   |                              |                 | 1               |                 | $fA/\sqrt{Hz}$ |
| Input Voltage Noise                            | $V_{NP-P}$        | $f = 0.1Hz$ to $10Hz$  |                              |                 | 2               |                 | $\mu VP-P$     |
| Input Voltage-Noise Density                    | $V_N$             | $f = 100Hz$  |                              |                 | 25              |                 | $nV/\sqrt{Hz}$ |
|  |                   | $f = 1kHz$   |                              |                 | 16.5            |                 |                |
|  |                   | $f = 10kHz$  |                              |                 | 15              |                 |                |
| Gain Bandwidth                                 | GBW               |  |                              |                 | 3               |                 | MHz            |
| Slew Rate                                      | SR                |  |                              |                 | 2.2             |                 | $V/\mu s$      |
| Capacitive Loading (Note 4)                    | $C_{LOAD}$        | No sustained oscillations  |                              |                 | 120             |                 | pF             |
| Total Harmonic Distortion                      | THD               | $V_{OUT} = 4.5VP-P$ , $A_V = 1V/V$ ,<br>$f = 10kHz$ , $R_{OUT} = 10k\Omega$ to GND |                              |                 | 97              |                 | dB             |
| <b>POWER-SUPPLY ELECTRICAL CHARACTERISTICS</b> |                   |  |                              |                 |                 |                 |                |
| Power-Supply Voltage Range                     | $V_{CC} - V_{EE}$ | Guaranteed by PSRR, $V_{EE} = 0$   |                              | +4.75           |                 | +38             | V              |
| Power-Supply Rejection Ratio                   | PSRR              | $V_{CC} - V_{EE} = +4.75V$ to $+38V$   |                              | 82              | 100             |                 | dB             |
| Quiescent Supply Current                       | $I_{CC}$          | $T_A = +25^\circ C$  |                              |                 | 400             | 700             | $\mu A$        |
|  |                   | $T_A = T_{MIN}$ to $T_{MAX}$   |                              |                 |                 | 850             |                |

**Note 2:** All devices are 100% production tested at  $T_A = +25^\circ C$ . All temperature limits are guaranteed by design.

**Note 3:**  $IN+$  and  $IN-$  are internally connected to the gates of CMOS transistors. CMOS GATE leakage is so small that it is impractical to test in production. Devices are screened during production testing to eliminate defective units.

**Note 4:** Specified over all temperatures and process variation by circuit simulation.

# 38V, Low-Noise, MOS-Input, Low-Power Op Amp

## Typical Operating Characteristics

( $V_{CC} = +15V$ ,  $V_{EE} = -15V$ ,  $V_{IN+} = V_{IN-} = GND = 0$ ,  $R_{OUT} = 100k\Omega$  to GND,  $T_A = -40^\circ C$  to  $+125^\circ C$ , typical values are at  $T_A = +25^\circ C$ , unless otherwise noted.)

**QUIESCENT SUPPLY CURRENT vs. SUPPLY VOLTAGE AND TEMPERATURE**

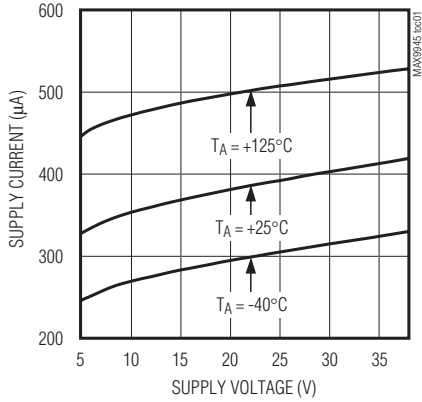

**OUTPUT VOLTAGE SWING LOW vs. TEMPERATURE**

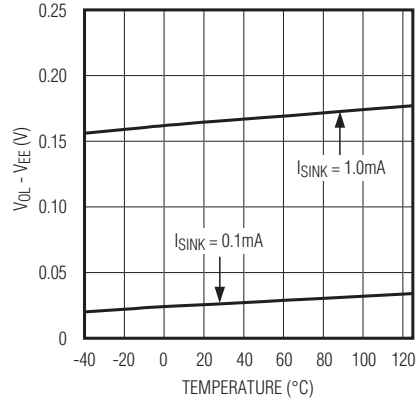

**OUTPUT VOLTAGE SWING HIGH vs. TEMPERATURE**

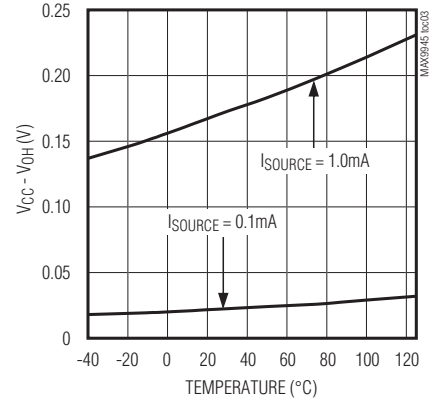

**INPUT BIAS CURRENT vs. TEMPERATURE**

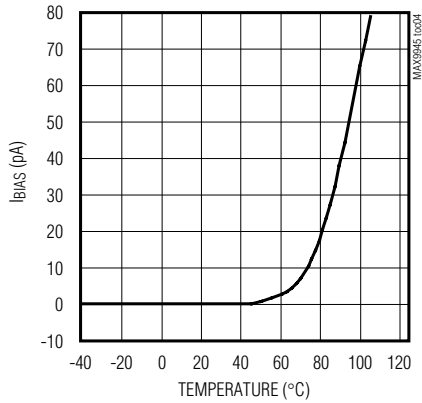

**INPUT VOLTAGE 0.1Hz TO 10Hz NOISE**

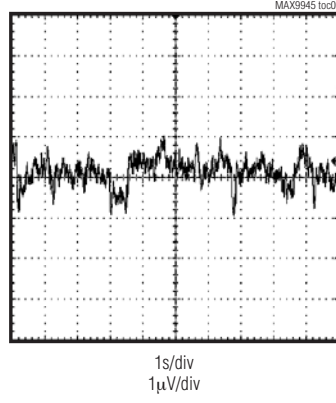

**INPUT VOLTAGE-NOISE DENSITY vs. FREQUENCY**

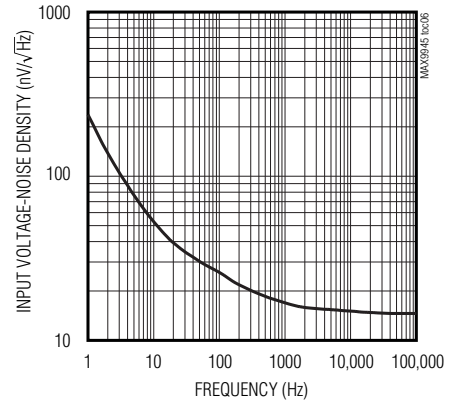

**TOTAL HARMONIC DISTORTION vs. FREQUENCY**

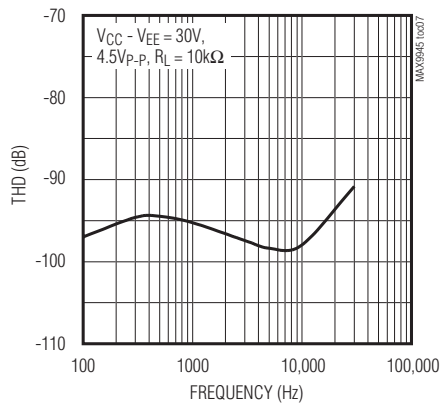

**TOTAL HARMONIC DISTORTION + NOISE vs. FREQUENCY**

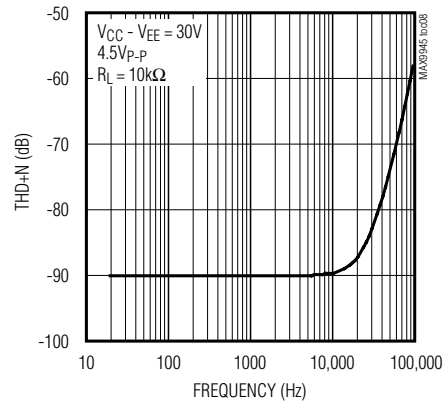

# 38V, Low-Noise, MOS-Input, Low-Power Op Amp

MAX9945

## Typical Operating Characteristics (continued)

( $V_{CC} = +15V$ ,  $V_{EE} = -15V$ ,  $V_{IN+} = V_{IN-} = GND = 0$ ,  $R_{OUT} = 100k\Omega$  to GND,  $T_A = -40^\circ C$  to  $+125^\circ C$ , typical values are at  $T_A = +25^\circ C$ , unless otherwise noted.)

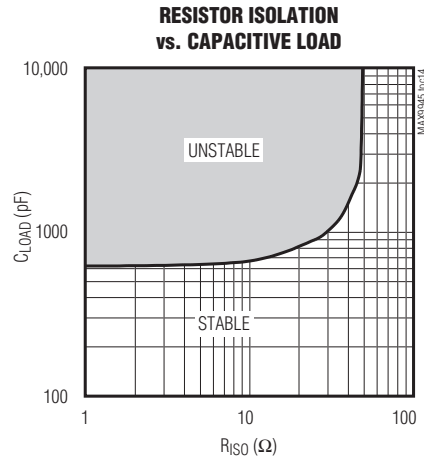
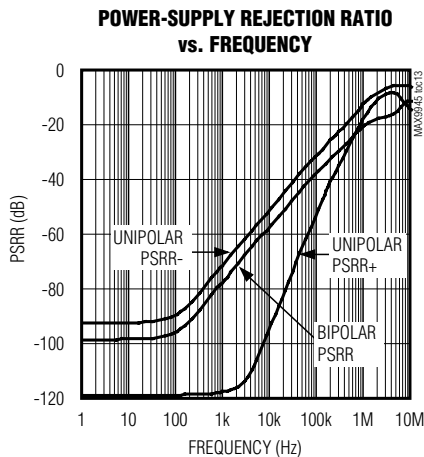
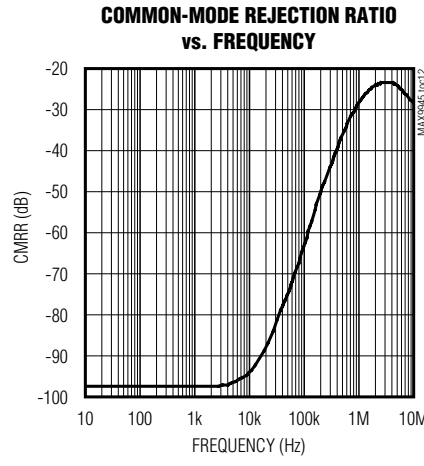
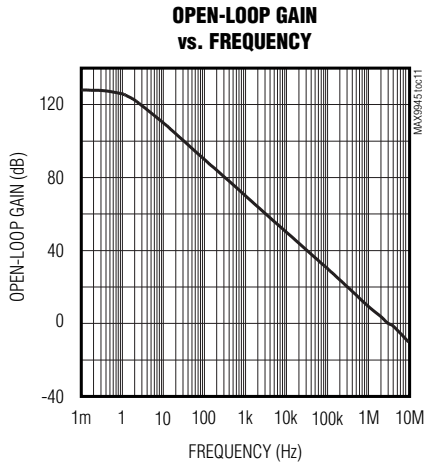
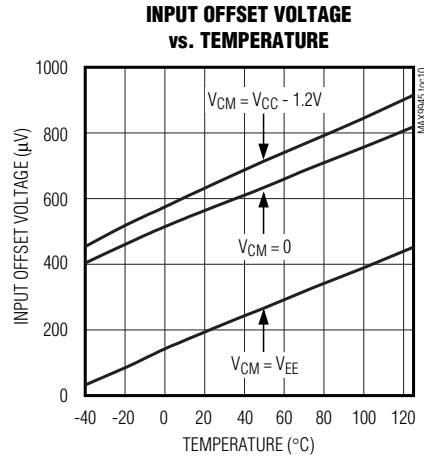
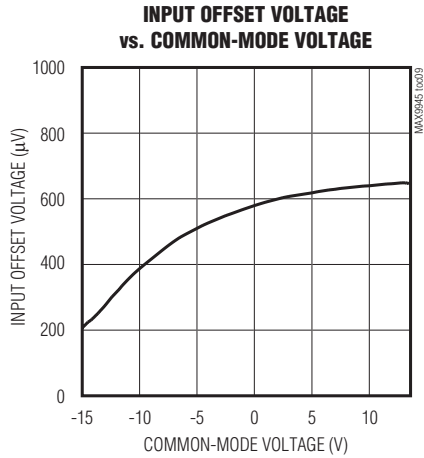

# 38V, Low-Noise, MOS-Input, Low-Power Op Amp

## Typical Operating Characteristics (continued)

( $V_{CC} = +15V$ ,  $V_{EE} = -15V$ ,  $V_{IN+} = V_{IN-} = GND = 0$ ,  $R_{OUT} = 100k\Omega$  to GND,  $T_A = -40^\circ C$  to  $+125^\circ C$ , typical values are at  $T_A = +25^\circ C$ , unless otherwise noted.)

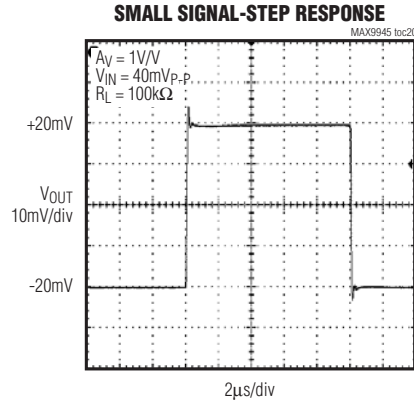
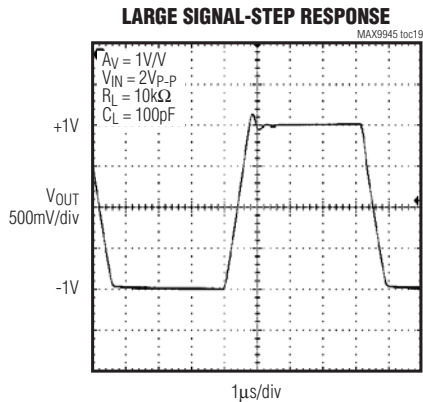
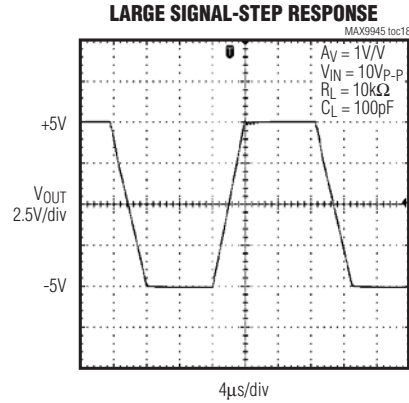
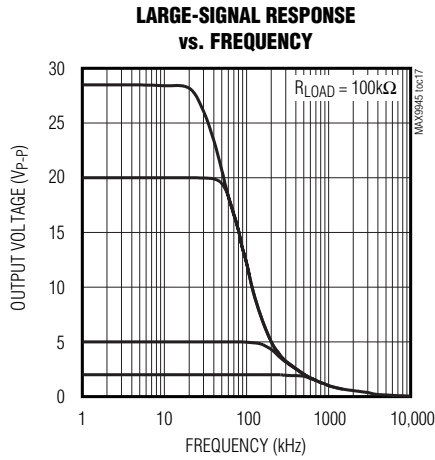
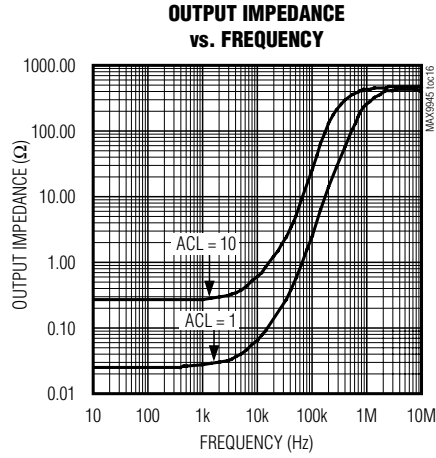
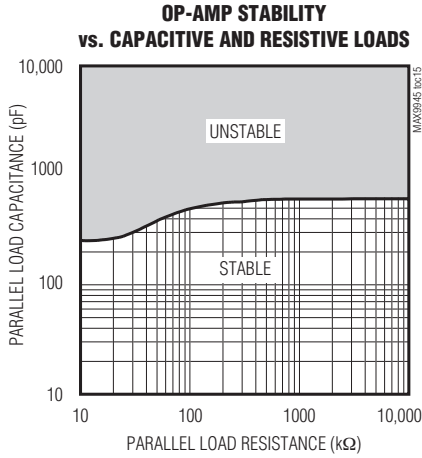

# 38V, Low-Noise, MOS-Input, Low-Power Op Amp

MAX9945

## Pin Description

| PIN     |         | NAME            | FUNCTION   |
|---------|---------|-----------------|--|
| TDFN-EP | μMAX    |                 |  |
| 1       | 6       | OUT             | Amplifier Output   |
| 2       | 4       | V <sub>EE</sub> | Negative Power Supply. Bypass V <sub>EE</sub> with 0.1μF ceramic and 4.7μF electrolytic capacitors to quiet ground plane if different from V <sub>EE</sub> .               |
| 3       | 3       | IN+             | Noninverting Amplifier Input   |
| 4       | 2       | IN-             | Inverting Amplifier Input  |
| 5       | 1, 5, 8 | N.C.            | No Connection. Not internally connected.   |
| 6       | 7       | V <sub>CC</sub> | Positive Power Supply. Bypass V <sub>CC</sub> with 0.1μF ceramic and 4.7μF electrolytic capacitors to quiet ground plane or V <sub>EE</sub> .                              |
| —       | —       | EP              | Exposed Pad. Connect to V <sub>EE</sub> externally. Connect to a large copper plane to maximize thermal performance. Not intended as an electrical connection (TDFN only). |

## Detailed Description

The MAX9945 features a combination of low input current and voltage noise, rail-to-rail output voltage swing, wide supply voltage range, and low-power operation. The MOS inputs on the MAX9945 make it ideal for use as transimpedance amplifiers and high-impedance sensor interface front-ends in medical and industrial applications. The MAX9945 can interface with small signals from either current-sources or high-output impedance voltage sources. Applications include photodiode pulse oximeters, pH sensors, capacitive pressure sensors, chemical analysis equipment, smoke detectors, and humidity sensors.

A high 130dB open-loop gain (typ) and a wide supply voltage range, allow high signal-gain implementations prior to signal conditioning circuitry. Low quiescent supply current makes the MAX9945 compatible with portable systems and applications that operate under tight power budgets. The combination of excellent THD, low voltage noise, and MOS inputs also make the MAX9945 ideal for use in high-performance active filters for data acquisition systems and audio equipment.

### Low-Current, Low-Noise Input Stage

The MAX9945 features a MOS-input stage with only 50fA (typ) of input bias current and a low 1fA/√Hz (typ) input current-noise density. The low-frequency input voltage noise is a low 2μV<sub>P-P</sub> (typ). The input stage accepts a wide common-mode range, extending from the negative supply, V<sub>EE</sub>, to within 1.2V of the positive supply, V<sub>CC</sub>.

### Rail-to-Rail Output Stage

The MAX9945 output stage swings to within 50mV (typ) of either power-supply rail with a 100kΩ load and provides a 3MHz GBW with a 2.2V/μs slew rate. The device is unity-gain stable, and unlike other devices with a low quiescent current, can drive a 120pF capacitive load without compromising stability.

## Applications Information

### High-Impedance Sensor Front Ends

High-impedance sensors can output signals of interest in either current or voltage form. The MAX9945 interfaces to both current-output sensors such as photodiodes and potentiostat sensors, and high-impedance voltage sources such as pH sensors.

For current-output sensors, a transimpedance amplifier is the most noise-efficient method for converting the input signal to a voltage. High-value feedback resistors are commonly chosen to create large gains, while feedback capacitors help stabilize the amplifier by canceling any zeros in the transfer function created by a highly capacitive sensor or cabling. A combination of low-current noise and low-voltage noise is important for these applications. Take care to calibrate out photodiode dark current if DC accuracy is important. The high bandwidth and slew rate also allows AC signal processing in certain medical photodiode sensor applications such as pulse oximetry.

# 38V, Low-Noise, MOS-Input, Low-Power Op Amp

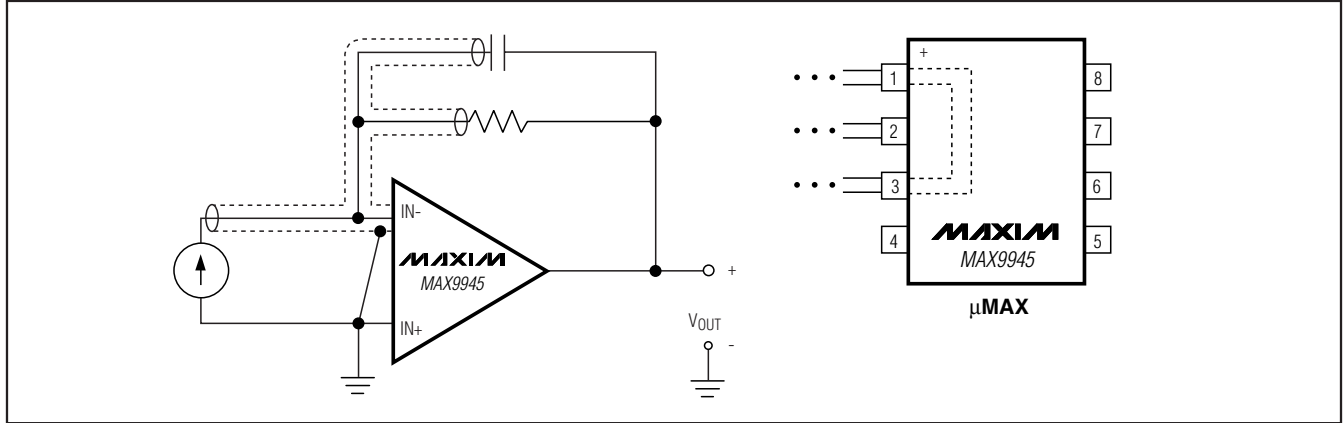

Figure 1. Shielding the Inverting Input to Reduce Leakage

For voltage-output sensors, a noninverting amplifier is typically used to buffer and/or apply a small gain to the input voltage signal. Due to the extremely high impedance of the sensor output, a low input bias current with a small temperature variation is very important for these applications.

### Power-Supply Decoupling

The MAX9945 operates from a +4.75V to +38V,  $V_{EE}$  referenced power supply. Bypass the power-supply inputs  $V_{CC}$  and  $V_{EE}$  to a quiet copper ground plane, with a 0.1 $\mu$ F ceramic capacitor in parallel with a 4.7 $\mu$ F electrolytic capacitor, placed close to the leads.

### Layout Techniques

A good layout is critical to obtaining high performance especially when interfacing with high-impedance sensors. Use shielding techniques to guard against parasitic leakage paths. For transimpedance applications, for example, surround the inverting input, and the traces connecting to it, with a buffered version of its own voltage. A convenient source of this voltage is the noninverting input pin. Pins 1, 5, and 8 on the  $\mu$ MAX package are unconnected, and can be connected to an analog common potential, or to the driven guard potential, to reduce leakage on the inverting input.

A good layout guard rail isolates sensitive nodes, such as the inverting input of the MAX9945 and the traces connecting to it (see Figure 1), from varying or large voltage differentials that otherwise occur in the rest of the circuit board. This reduces leakage and noise effects, allowing sensitive measurements to be made accurately.

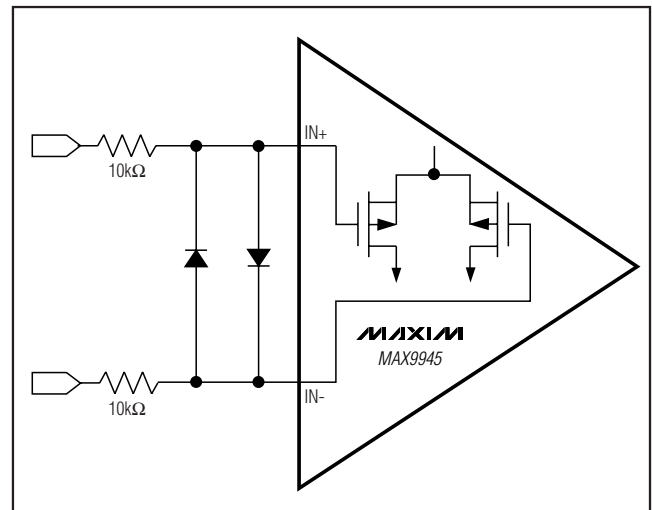

Figure 2. Input Differential Voltage Protection

Take care to also decrease the amount of stray capacitance at the op amp's inputs to improve stability. To achieve this, minimize trace lengths and resistor leads by placing external components as close as possible to the package. If the sensor is inherently capacitive, or is connected to the amplifier through a long cable, use a low-value feedback capacitor to control high-frequency gain and peaking to stabilize the feedback loop.



# 38V, Low-Noise, MOS-Input, Low-Power Op Amp

## **Input Differential Voltage Protection**

During normal op-amp operation, the inverting and non-inverting inputs of the MAX9945 are at approximately the same voltage. The  $\pm 12\text{V}$  absolute maximum input differential voltage rating offers sufficient protection for most applications. If there is a possibility of exceeding the input differential voltage specification, in the presence of extremely fast input voltage transients or due to certain application-specific fault conditions, use external low-leakage pico-amp diodes and series resistors to protect the input stage of the amplifier (see Figure 2). The extremely low input bias current of the MAX9945 allows a wide range of input series resistors to be used. If low input voltage noise is critical to the application, size the input series resistors appropriately.

## **Chip Information**

PROCESS: BiCMOS

**MAX9945**

# 38V, Low-Noise, MOS-Input, Low-Power Op Amp

## Pin Configurations

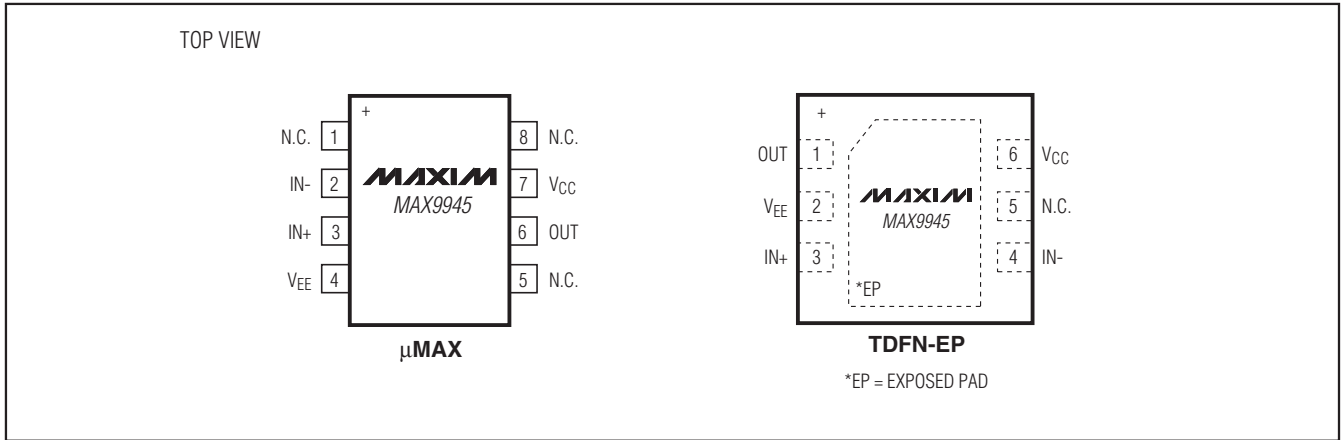

# 38V, Low-Noise, MOS-Input, Low-Power Op Amp

## Package Information

For the latest package outline information and land patterns, go to [www.maxim-ic.com/packages](http://www.maxim-ic.com/packages).

MAX9945

| PACKAGE TYPE | PACKAGE CODE | DOCUMENT NO.            |
|--------------|--------------|-------------------------|
| 6 TDFN-EP    | T633-2       | <a href="#">21-0137</a> |
| 8 $\mu$ MAX  | U8-1         | <a href="#">21-0036</a> |

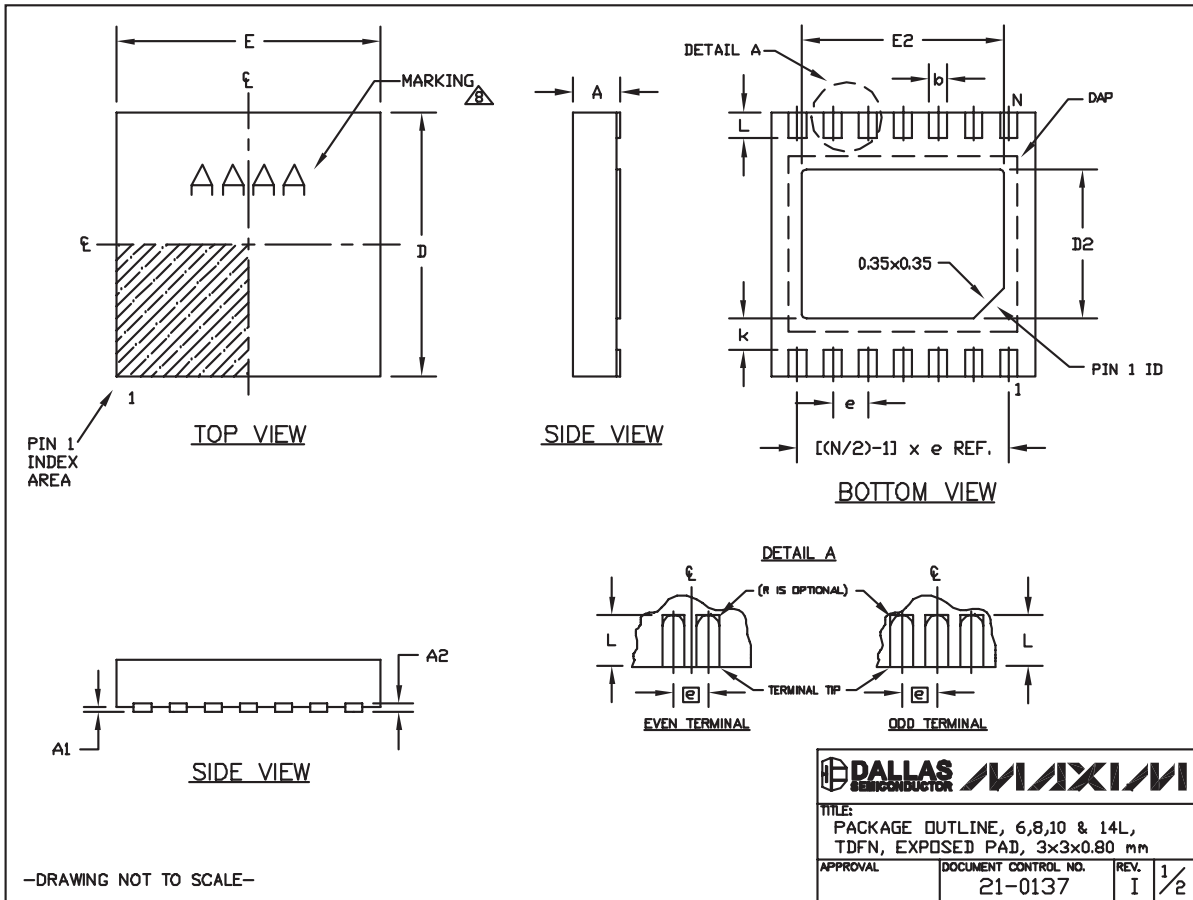

# 38V, Low-Noise, MOS-Input, Low-Power Op Amp

## Package Information (continued)

For the latest package outline information and land patterns, go to [www.maxim-ic.com/packages](http://www.maxim-ic.com/packages).



| COMMON DIMENSIONS |           |      |
|-------------------|-----------|------|
| SYMBOL            | MIN.      | MAX. |
| A                 | 0.70      | 0.80 |
| D                 | 2.90      | 3.10 |
| E                 | 2.90      | 3.10 |
| A1                | 0.00      | 0.05 |
| L                 | 0.20      | 0.40 |
| k                 | 0.25 MIN. |      |
| A2                | 0.20 REF. |      |

| PACKAGE VARIATIONS |    |           |           |          |                |           |               |  |
|--------------------|----|-----------|-----------|----------|----------------|-----------|---------------|--|
| PKG. CODE          | N  | D2        | E2        | e        | JEDEC SPEC     | b         | [(N/2)-1] x e |  |
| T633-2             | 6  | 1.50±0.10 | 2.30±0.10 | 0.95 BSC | MO229 / WEEA   | 0.40±0.05 | 1.90 REF      |  |
| T833-2             | 8  | 1.50±0.10 | 2.30±0.10 | 0.65 BSC | MO229 / WEEC   | 0.30±0.05 | 1.95 REF      |  |
| T833-3             | 8  | 1.50±0.10 | 2.30±0.10 | 0.65 BSC | MO229 / WEEC   | 0.30±0.05 | 1.95 REF      |  |
| T1033-1            | 10 | 1.50±0.10 | 2.30±0.10 | 0.50 BSC | MO229 / WEED-3 | 0.25±0.05 | 2.00 REF      |  |
| T1033-2            | 10 | 1.50±0.10 | 2.30±0.10 | 0.50 BSC | MO229 / WEED-3 | 0.25±0.05 | 2.00 REF      |  |
| T1433-1            | 14 | 1.70±0.10 | 2.30±0.10 | 0.40 BSC | ----           | 0.20±0.05 | 2.40 REF      |  |
| T1433-2            | 14 | 1.70±0.10 | 2.30±0.10 | 0.40 BSC | ----           | 0.20±0.05 | 2.40 REF      |  |

**NOTES:**

1. ALL DIMENSIONS ARE IN mm. ANGLES IN DEGREES.
  2. COPLANARITY SHALL NOT EXCEED 0.08 mm.
  3. WARPAGE SHALL NOT EXCEED 0.10 mm.
  4. PACKAGE LENGTH/PACKAGE WIDTH ARE CONSIDERED AS SPECIAL CHARACTERISTIC(S).
  5. DRAWING CONFORMS TO JEDEC MO229, EXCEPT DIMENSIONS "D2" AND "E2", AND T1433-1 & T1433-2.
  6. "N" IS THE TOTAL NUMBER OF LEADS.
  7. NUMBER OF LEADS SHOWN ARE FOR REFERENCE ONLY.
-  MARKING IS FOR PACKAGE ORIENTATION REFERENCE ONLY.

—DRAWING NOT TO SCALE—

|   |  |                      |
|---|--|----------------------|
|   |  |                      |
| <b>TITLE:</b><br>PACKAGE OUTLINE, 6,8,10 & 14L,<br>TDFN, EXPOSED PAD, 3x3x0.80 mm   |  |                      |
| <b>APPROVAL</b>   | <b>DOCUMENT CONTROL NO.</b><br>21-0137 | <b>REV.</b><br>I 2/2 |

# 38V, Low-Noise, MOS-Input, Low-Power Op Amp

## Package Information (continued)

For the latest package outline information and land patterns, go to [www.maxim-ic.com/packages](http://www.maxim-ic.com/packages).

MAX9945

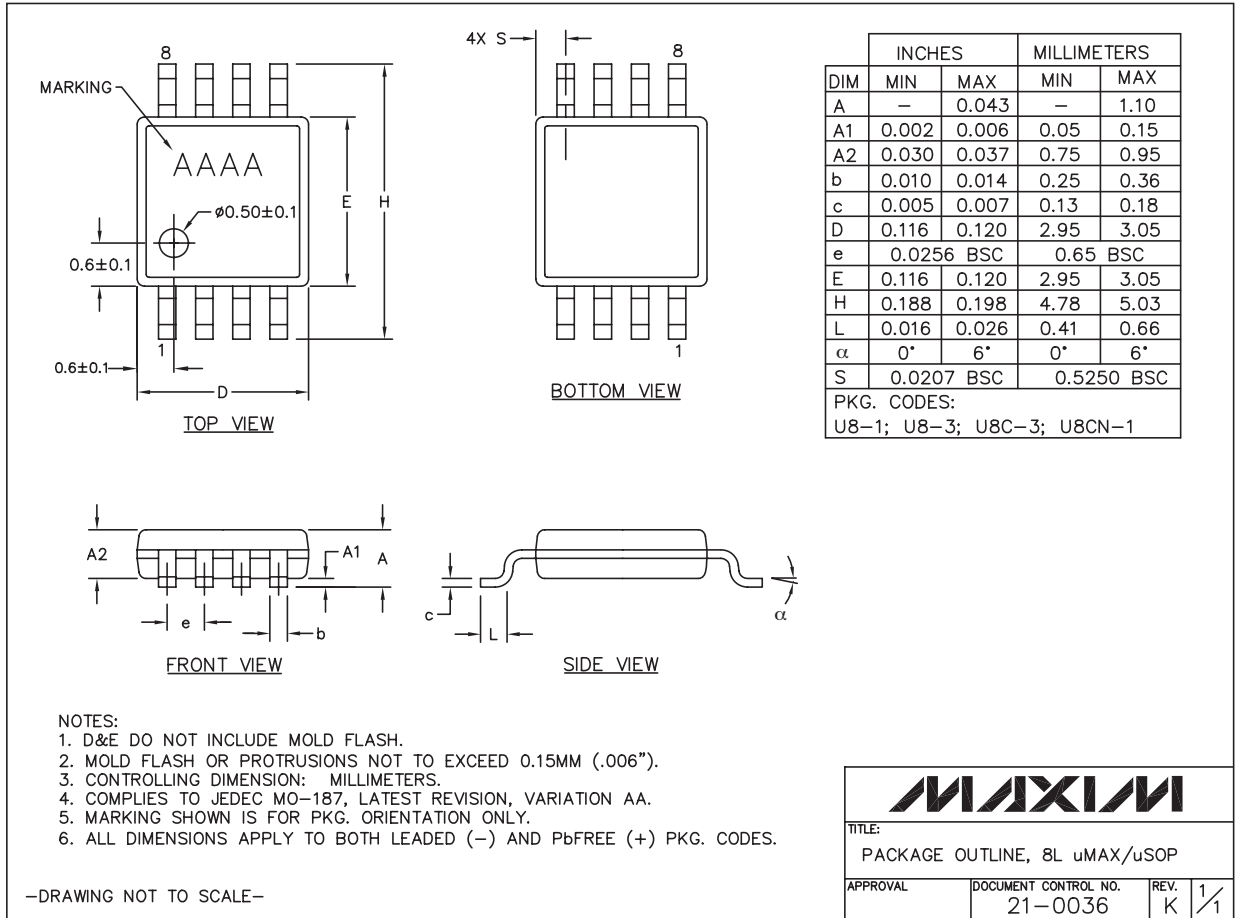

8LUMAXD.EPS

**MAXIM**

|   |                                 |           |     |
|---|---------------------------------|-----------|-----|
| TITLE:<br>PACKAGE OUTLINE, 8L uMAX/uSOP |                                 |           |     |
| APPROVAL                                | DOCUMENT CONTROL NO.<br>21-0036 | REV.<br>K | 1/1 |

Maxim cannot assume responsibility for use of any circuitry other than circuitry entirely embodied in a Maxim product. No circuit patent licenses are implied. Maxim reserves the right to change the circuitry and specifications without notice at any time.

Maxim Integrated Products, 120 San Gabriel Drive, Sunnyvale, CA 94086 408-737-7600 \_\_\_\_\_ 13