



# MICROCHIP MCP1790/MCP1791

## 70 mA, High Voltage Regulator

### Features

- 48V (43.5V  $\pm$ 10%) load dump protected for 180ms with a 30 second repetition rate (FORD Test Pulse G Loaded)
- Wide steady state supply voltage, 6.0V - 30.0V
- Extended Junction Temperature Range: -40 to +125°C
- Fixed output voltages: 3.0V, 3.3V, 5.0V
- Low quiescent current: 70  $\mu$ A typical
- Low shutdown quiescent current: 10  $\mu$ A typical
- Output Voltage Tolerances of  $\pm$ 2.5% over the temperature range
- Maximum output current of 70 mA @ +125°C Junction Temperature
- Maximum continuous input voltage of 30V
- Internal thermal overload protection, +157°C (typical) Junction Temperature
- Internal short circuit current limit, 120 mA (typical) for +5V option.
- Short Circuit Current Foldback
- Shutdown Input option (MCP1791)
- Power Good Output option (MCP1791)
- High PSRR, -90 dB@100 Hz (typical)
- Stable with 1  $\mu$ F to 1000  $\mu$ F Tantalum and Electrolytic Capacitors
- Stable with 4.7  $\mu$ F to 1000  $\mu$ F Ceramic Capacitors

### Applications

- Low Voltage A/C powered (24VAC) Fire Alarms, CO<sub>2</sub> Sensors, HVAC Controls
- Automotive Electronics
- Automotive Accessory Power Adapters
- Electronic Thermostat Controls
- Microcontroller power

### General Description

The MCP1790/MCP1791 regulator provides up to 70 mA of current. The input operating voltage range is specified from 6.0V to 30V continuous, 48V absolute max, making it ideal for automotive and commercial 12/24 VDC systems.

The MCP1790/MCP1791 has a tight tolerance output voltage load regulation of  $\pm$ 0.2% (typical) and a very good line regulation at  $\pm$ 0.0002%/V (typical). The regulator output is stable with ceramic, tantalum, and electrolytic capacitors. The MCP1790/MCP1791 regulator incorporates both thermal and short circuit protection.

The MCP1790 is the 3-pin version of the MCP1790/MCP1791 family. The MCP1791 is the 5-pin version and incorporates a Shutdown input signal and a Power Good output signal.

The regulator is specifically designed to operate in the automotive environment and will survive +48V (43.5V  $\pm$ 10%) load dump transients and double-battery jumps. The device is designed to meet the stringent quiescent current requirements of the automotive industry. The device is also designed for the commercial low voltage fire alarm/detector systems which use 24 VDC to supply the required alarms throughout buildings. The low ground current, 110  $\mu$ A (typ.), of the CMOS device will provide a power cost savings to the end users over similar bipolar devices. Typical buildings using hundreds of 24V powered fire and smoke detectors can see substantial savings on energy consumption and wiring gage reduction compared to bipolar regulators.

The MCP1790 device will be offered in the 3-pin DD-PAK, and SOT-223 packages.

The MCP1791 device will be offered in the 5-pin DD-PAK, and SOT-223 packages.

The MCP1790/MCP1791 will have a junction temperature operating range of -40°C to +125°C.

# MCP1790/MCP1791

## Package Types

MCP1790

DDPAK-3

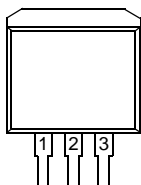

SOT-223-3

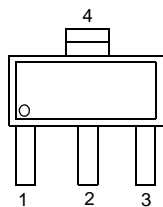

Pin	
1	$V_{IN}$
2	GND (TAB)
3	$V_{OUT}$
4	GND (TAB)

MCP1791

DDPAK-5

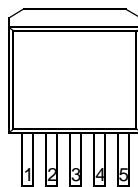

SOT-223-5

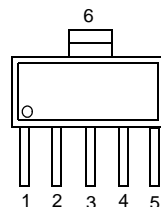

Pin	
1	SHDN
2	$V_{IN}$
3	GND (TAB)
4	$V_{OUT}$
5	PWRGD
6	GND (TAB)

# MCP1790/MCP1791

## TYPICAL APPLICATION

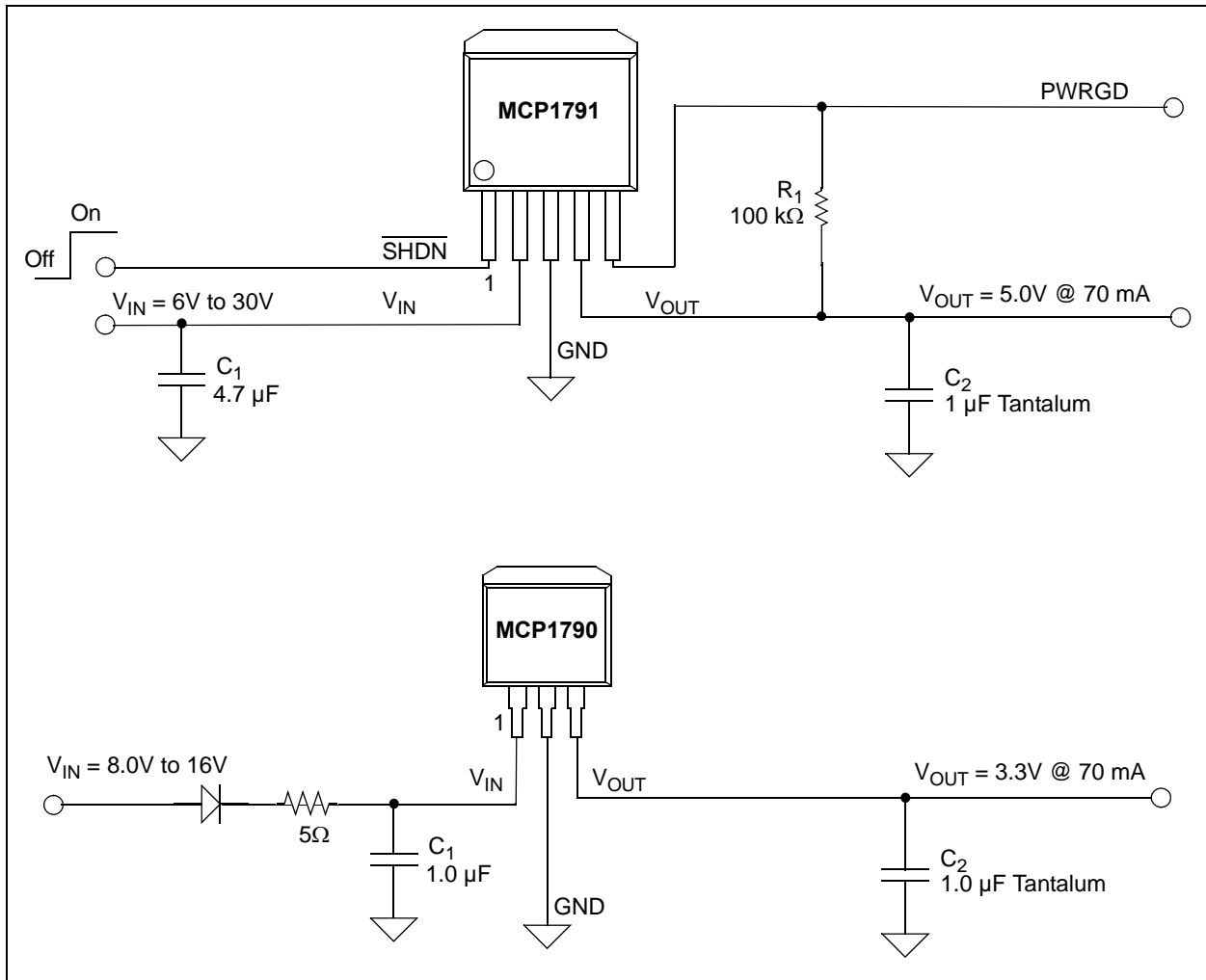

# MCP1790/MCP1791

## 1.0 ELECTRICAL CHARACTERISTICS

### Absolute Maximum Ratings †

Input Voltage, $V_{IN}$ .....	+48.0V
$V_{IN}$ , PWRGD, $\overline{SHDN}$ .....	(GND-0.3V) to ( $V_{IN}$ +0.3V)
$V_{OUT}$ .....	(GND-0.3V) to (+5.5V)
Internal Power Dissipation .....	Internally-Limited ( <b>Note 4</b> )
Output Short Circuit Current.....	Continuous
Storage temperature .....	-55°C to +150°C
Maximum Junction Temperature.....	165°C ( <b>Note 7</b> )
Operating Junction Temperature.....	-40°C to +125°C
ESD protection on all pins.....	≥ 6 kV HBM and ≥ 400V MM

† **Notice:** Stresses above those listed under “Maximum Ratings” may cause permanent damage to the device. This is a stress rating only and functional operation of the device at those or any other conditions above those indicated in the operational listings of this specification is not implied. Exposure to maximum rating conditions for extended periods may affect device reliability.

### AC/DC CHARACTERISTICS

<b>Electrical Specifications:</b> Unless otherwise noted, $V_{IN} = V_{OUT(MAX)} + V_{DROPOUT(MAX)}$ , ( <b>Note 1</b> ), $I_{OUT} = 1$ mA, $C_{OUT} = 4.7$ $\mu$ F (X7R Ceramic), $C_{IN} = 4.7$ $\mu$ F (X7R Ceramic), $T_A = +25^\circ\text{C}$ , $\overline{SHDN} > 2.4\text{V}$ . <b>Boldface</b> type applies for junction temperatures, $T_J$ ( <b>Note 5</b> ) of <b>-40°C to +125°C</b> .						
Parameters	Symbol	Min	Typ	Max	Units	Conditions
Input Operating Voltage	$V_{IN}$	<b>6.0</b>	—	<b>30.0</b>	V	+48V <sub>DC</sub> Load Dump Peak < 500 ms
Input Quiescent Current	$I_q$	—	70	<b>130</b>	$\mu$ A	$I_L = 0$ mA
Input Quiescent Current for $\overline{SHDN}$ Mode	$I_{\overline{SHDN}}$	—	10	<b>25</b>	$\mu$ A	$\overline{SHDN} = \text{GND}$
Ground Current	$I_{GND}$	—	110	<b>210</b>	$\mu$ A	$I_L = 70$ mA
Maximum Output Current	$I_{OUT}$	<b>70</b>	—	—	mA	
Line Regulation	$\frac{\Delta V_{OUT}}{(V_{OUT} \times \Delta V_{IN})}$	—	±0.0002	<b>±0.05</b>	%/V	6.0V < $V_{IN}$ < 30V
Load Regulation	$\Delta V_{OUT}/V_{OUT}$	<b>-0.45</b>	±0.2	<b>0.45</b>	%	$I_{OUT} = 1$ mA to 70 mA ( <b>Note 3</b> )
Output Peak Short Circuit Current	$I_{OUT\_SC}$	—	$V_R/10$	—	A	$R_{LOAD} < 0.1 \Omega$ , Peak Current
Output Voltage Regulation	$V_{OUT}$	<b><math>V_R - 2.5\%</math></b>	$V_R$	<b><math>V_R + 2.5\%</math></b>	V	6.0V < $V_{IN}$ < 30V
$V_{OUT}$ Temperature Coefficient	$TCV_{OUT}$	—	65	—	ppm/°C	<b>Note 9</b>
Input Voltage to Turn On Output	$V_{ON}$	—	5.5	<b>6.0</b>	V	Rising $V_{IN}$

- Note 1:** The minimum  $V_{IN}$ ,  $V_{IN(MIN)}$  must meet two conditions:  $V_{IN} \geq 6.0\text{V}$  and  $V_{IN} \geq V_{OUT(MAX)} + V_{DROPOUT(MAX)}$ .
- 2:**  $V_R$  is the nominal regulator output voltage.
- 3:** Load regulation is measured at a constant junction temperature using low duty cycle pulse testing. Load regulation is tested over a load range from 1 mA to the maximum specified output current.
- 4:** The maximum allowable power dissipation is a function of ambient temperature, the maximum allowable junction temperature and the thermal resistance from junction to air. (i.e.,  $T_A$ ,  $T_J$ ,  $\theta_{JA}$ ). Exceeding the maximum allowable power dissipation will cause the device operating junction temperature to exceed the maximum 165°C rating. Sustained junction temperatures above 165°C can impact the device reliability.
- 5:** The junction temperature is approximated by soaking the device under test at an ambient temperature equal to the desired Junction temperature. The test time is small enough such that the rise in the Junction temperature over the ambient temperature is not significant.
- 6:** Dropout voltage is defined as the input-to-output voltage differential at which the output voltage drops 2% below its nominal value that was measured with an input voltage of  $V_{IN} = V_R + V_{DROPOUT(MAX)}$ .
- 7:** Sustained junction temperatures above 165°C can impact the device reliability.
- 8:** The Short Circuit Recovery Time test is done by placing the device into a short circuit condition and then removing the short circuit condition before the device die temperature reaches 125 °C. If the device goes into thermal shutdown, then the Short Circuit Recovery Time will depend upon the thermal dissipation properties of the package and circuit board.
- 9:**  $TCV_{OUT} = (V_{OUT-HIGH} - V_{OUT-LOW}) * 10^6 / (V_R * \Delta\text{Temperature})$ ,  $V_{OUT-HIGH}$  = highest voltage measured over the temperature range.  $V_{OUT-LOW}$  = lowest voltage measured over the temperature range.

## AC/DC CHARACTERISTICS (CONTINUED)

**Electrical Specifications:** Unless otherwise noted,  $V_{IN} = V_{OUT(MAX)} + V_{DROPOUT(MAX)}$ , (**Note 1**),  $I_{OUT} = 1 \text{ mA}$ ,  $C_{OUT} = 4.7 \mu\text{F}$  (X7R Ceramic),  $C_{IN} = 4.7 \mu\text{F}$  (X7R Ceramic),  $T_A = +25^\circ\text{C}$ , SHDN > 2.4V.  
**Boldface type applies for junction temperatures,  $T_J$  (**Note 5**) of  $-40^\circ\text{C}$  to  $+125^\circ\text{C}$ .**

Parameters	Symbol	Min	Typ	Max	Units	Conditions
Short Circuit Foldback Voltage Corner	$V_{FOLDBACK}$	—	4.2	—	V	$V_R = 5.0\text{V}$ Falling $V_{OUT}$ , $R_{LOAD} < 0.1 \Omega$
		—	3.0	—	V	$V_R = 3.3\text{V}$ Falling $V_{OUT}$ , $R_{LOAD} < 0.1 \Omega$
		—	2.7	—	V	$V_R = 3.0\text{V}$ Falling $V_{OUT}$ , $R_{LOAD} < 0.1 \Omega$
Short Circuit Foldback Current		—	105	—	mA	$V_{OUT} \approx 0\text{V}$ , $R_{LOAD} < 0.1 \Omega$ , $V_R = 5.0\text{V}$ ( <b>Note 2</b> )
		—	99	—	mA	$V_R = 3.3\text{V}$ ( <b>Note 2</b> )
		—	99	—	mA	$V_R = 3.0\text{V}$ ( <b>Note 2</b> )
Startup Voltage Overshoot	$V_{OVER}$	—	0.10	—	% $V_{OUT}$	$V_{IN} = 0\text{V}$ to $6.0\text{V}$
Dropout Voltage	$V_{DROPOUT}$	—	700	<b>1300</b>	mV	$I_{OUT} = 70 \text{ mA}$ , ( <b>Note 6</b> )
Dropout Current $I_{OUT} = 0 \text{ mA}$	$I_{DO}$	—	130	—	$\mu\text{A}$	$V_R = 5.0\text{V}$ , $V_{IN} = 4.500\text{V}$
		—	75	—	$\mu\text{A}$	$V_R = 3.3\text{V}$ , $V_{IN} = 4.500\text{V}$
		—	75	—	$\mu\text{A}$	$V_R = 3.0\text{V}$ , $V_{IN} = 4.500\text{V}$
<b>Shutdown Input</b>						
Logic High Input	$V_{SHDN-HIGH}$	<b>2.4</b>	—	$V_{IN(MAX)}$	V	
Logic Low Input	$V_{SHDN-LOW}$	0	—	<b>0.8</b>	V	
Shutdown Input Leakage Current	$SHDN_{ILK}$	—	0.100	<b>0.500</b>	$\mu\text{A}$	SHDN = GND
		—	3.0	<b>5.0</b>		SHDN = 6V
<b>Power Good Characteristics</b>						
PWRGD Input Voltage Operating Range	$V_{PWRGD\_VIN}$	<b>2.8</b>	—	—	V	
PWRGD Threshold Voltage (Referenced to $V_{OUT}$ )	$V_{PWRGD\_TH}$	<b>88</b>	90	<b>92</b>	% $V_{OUT}$	Falling Edge of $V_{OUT}$
PWRGD Threshold Hysteresis	$V_{PWRGD\_HYS}$	<b>1.0</b>	2.0	<b>3.0</b>	% $V_{OUT}$	Rising Edge of $V_{OUT}$
PWRGD Output Voltage LOW	$V_{PWRGD\_L}$	—	0.2	<b>0.4</b>	V	$I_{PWRGD\_SINK} = 5.0 \text{ mA}$ , $V_{OUT} = 0\text{V}$
PWRGD Output Sink Current	$I_{PWRGD\_L}$	5.0	—	—	mA	$V_{PWRGD} \leq 0.4\text{V}$
PWRGD Leakage	$I_{PWRGD\_LK}$	—	1.0	—	nA	$V_{PWRGD} = V_{IN} = 6.0\text{V}$
PWRGD Time Delay	$T_{PG}$	—	30	—	$\mu\text{s}$	Rising Edge

- Note 1:** The minimum  $V_{IN}$ ,  $V_{IN(MIN)}$  must meet two conditions:  $V_{IN} \geq 6.0\text{V}$  and  $V_{IN} \geq V_{OUT(MAX)} + V_{DROPOUT(MAX)}$ .
- 2:**  $V_R$  is the nominal regulator output voltage.
- 3:** Load regulation is measured at a constant junction temperature using low duty cycle pulse testing. Load regulation is tested over a load range from 1 mA to the maximum specified output current.
- 4:** The maximum allowable power dissipation is a function of ambient temperature, the maximum allowable junction temperature and the thermal resistance from junction to air. (i.e.,  $T_A$ ,  $T_J$ ,  $\theta_{JA}$ ). Exceeding the maximum allowable power dissipation will cause the device operating junction temperature to exceed the maximum  $165^\circ\text{C}$  rating. Sustained junction temperatures above  $165^\circ\text{C}$  can impact the device reliability.
- 5:** The junction temperature is approximated by soaking the device under test at an ambient temperature equal to the desired Junction temperature. The test time is small enough such that the rise in the Junction temperature over the ambient temperature is not significant.
- 6:** Dropout voltage is defined as the input-to-output voltage differential at which the output voltage drops 2% below its nominal value that was measured with an input voltage of  $V_{IN} = V_R + V_{DROPOUT(MAX)}$ .
- 7:** Sustained junction temperatures above  $165^\circ\text{C}$  can impact the device reliability.
- 8:** The Short Circuit Recovery Time test is done by placing the device into a short circuit condition and then removing the short circuit condition before the device die temperature reaches  $125^\circ\text{C}$ . If the device goes into thermal shutdown, then the Short Circuit Recovery Time will depend upon the thermal dissipation properties of the package and circuit board.
- 9:**  $TCV_{OUT} = (V_{OUT-HIGH} - V_{OUT-LOW}) * 10^6 / (V_R * \Delta\text{Temperature})$ ,  $V_{OUT-HIGH}$  = highest voltage measured over the temperature range.  $V_{OUT-LOW}$  = lowest voltage measured over the temperature range.

# MCP1790/MCP1791

## AC/DC CHARACTERISTICS (CONTINUED)

<b>Electrical Specifications:</b> Unless otherwise noted, $V_{IN} = V_{OUT(MAX)} + V_{DROPOUT(MAX)}$ , ( <b>Note 1</b> ), $I_{OUT} = 1 \text{ mA}$ , $C_{OUT} = 4.7 \mu\text{F}$ (X7R Ceramic), $C_{IN} = 4.7 \mu\text{F}$ (X7R Ceramic), $T_A = +25^\circ\text{C}$ , $\text{SHDN} > 2.4\text{V}$ . <b>Boldface type</b> applies for junction temperatures, $T_J$ ( <b>Note 5</b> ) of <b>-40°C to +125°C</b> .						
Parameters	Symbol	Min	Typ	Max	Units	Conditions
Detect Threshold to PWRGD Active Time Delay	$T_{V_{DET-PWRGD}}$	—	235	—	$\mu\text{s}$	$V_{OUT} = V_{PWRGD\_TH} + 100 \text{ mV}$ to $V_{PWRGD\_TH} - 100 \text{ mV}$
<b>AC Performance</b>						
Output Delay From $\overline{\text{SHDN}}$	$T_{OR}$	—	200	—	$\mu\text{s}$	$\text{SHDN} = \text{GND}$ to $V_{IN}$ , $V_{OUT} = \text{GND}$ to 95% $V_R$ , $C_{OUT} = 1.0 \mu\text{F}$
PWRGD Delay from $\overline{\text{SHDN}}$	$T_{\text{SHDN\_PG}}$	—	400	—	ns	$\text{SHDN} = V_{IN}$ to GND, $C_{OUT} = 1.0 \mu\text{F}$
Output Noise	$e_N$	—	1.2	—	$\mu\text{V}/\sqrt{\text{Hz}}$	$I_{OUT} = 50 \text{ mA}$ , $f = 1 \text{ kHz}$
Power Supply Ripple Rejection Ratio	PSRR	—	90	—	dB	$V_{IN} = 7.0\text{V}$ , $C_{IN} = 0 \mu\text{F}$ , $I_{OUT} = 10 \text{ mA}$ , $V_{INAC} = 400 \text{ mVpp}$
		—	75	—		$f = 100 \text{ Hz}$
		—	80	—		$f = 1 \text{ kHz}$ , $V_R = 5.0\text{V}$
		—	80	—		$f = 1 \text{ kHz}$ , $V_R = < 5.0\text{V}$
Thermal Shutdown Temperature	$T_{SD}$	—	157	—	$^\circ\text{C}$	Rising Temperature
Thermal Shutdown Hysteresis	$\Delta T_{SD}$	—	20	—	$^\circ\text{C}$	Falling Temperature
Short Circuit Recovery Time	$t_{THERM}$	—	0	—	ms	<b>(Note 8)</b>

- Note 1:** The minimum  $V_{IN}$ ,  $V_{IN(MIN)}$  must meet two conditions:  $V_{IN} \geq 6.0\text{V}$  and  $V_{IN} \geq V_{OUT(MAX)} + V_{DROPOUT(MAX)}$ .
- 2:**  $V_R$  is the nominal regulator output voltage.
- 3:** Load regulation is measured at a constant junction temperature using low duty cycle pulse testing. Load regulation is tested over a load range from 1 mA to the maximum specified output current.
- 4:** The maximum allowable power dissipation is a function of ambient temperature, the maximum allowable junction temperature and the thermal resistance from junction to air. (i.e.,  $T_A$ ,  $T_J$ ,  $\theta_{JA}$ ). Exceeding the maximum allowable power dissipation will cause the device operating junction temperature to exceed the maximum 165°C rating. Sustained junction temperatures above 165°C can impact the device reliability.
- 5:** The junction temperature is approximated by soaking the device under test at an ambient temperature equal to the desired Junction temperature. The test time is small enough such that the rise in the Junction temperature over the ambient temperature is not significant.
- 6:** Dropout voltage is defined as the input-to-output voltage differential at which the output voltage drops 2% below its nominal value that was measured with an input voltage of  $V_{IN} = V_R + V_{DROPOUT(MAX)}$ .
- 7:** Sustained junction temperatures above 165°C can impact the device reliability.
- 8:** The Short Circuit Recovery Time test is done by placing the device into a short circuit condition and then removing the short circuit condition before the device die temperature reaches 125 °C. If the device goes into thermal shutdown, then the Short Circuit Recovery Time will depend upon the thermal dissipation properties of the package and circuit board.
- 9:**  $TCV_{OUT} = (V_{OUT-HIGH} - V_{OUT-LOW}) * 10^6 / (V_R * \Delta\text{Temperature})$ ,  $V_{OUT-HIGH}$  = highest voltage measured over the temperature range.  $V_{OUT-LOW}$  = lowest voltage measured over the temperature range.

# MCP1790/MCP1791

## TEMPERATURE SPECIFICATIONS

Parameters	Symbol	Min	Typ	Max	Units	Conditions
<b>Temperature Ranges</b>						
Specified Temperature Range	$T_J$	-40		+125	°C	
Operating Temperature Range	$T_J$	-40		+125	°C	
Storage Temperature Range	$T_J$	-55		+150	°C	
<b>Package Thermal Resistances</b>						
Thermal Resistance, 3LD DDPAK	$\theta_{JA}$ $\theta_{JC}$	—	31.4 3	—	°C/W	EIA/JEDEC JESD51-751-7 4 Layer Board
Thermal Resistance, 3LD SOT-223	$\theta_{JA}$ $\theta_{JC}$	—	62 15	—	°C/W	EIA/JEDEC JESD51-751-7 4 Layer Board
Thermal Resistance, 5LD DDPAK	$\theta_{JA}$ $\theta_{JC}$	—	31.4 3	—	°C/W	EIA/JEDEC JESD51-751-7 4 Layer Board
Thermal Resistance, 5LD SOT-223	$\theta_{JA}$ $\theta_{JC}$	—	62 15	—	°C/W	EIA/JEDEC JESD51-751-7 4 Layer Board

# MCP1790/MCP1791

## 2.0 TYPICAL PERFORMANCE CHARACTERISTICS

**Note:** The graphs and tables provided following this note are a statistical summary based on a limited number of samples and are provided for informational purposes only. The performance characteristics listed herein are not tested or guaranteed. In some graphs or tables, the data presented may be outside the specified operating range (e.g., outside specified power supply range) and therefore outside the warranted range.

**Note:** Unless otherwise indicated,  $C_{OUT} = 4.7 \mu\text{F}$  Ceramic (X7R),  $C_{IN} = 10.0 \mu\text{F}$  Ceramic (X7R),  $I_{OUT} = 1 \text{ mA}$ , Temperature =  $+25^\circ\text{C}$ ,  $V_{IN} = 6.0\text{V}$ ,  $R_{PWRGD\_PULLUP} = 10 \text{ k}\Omega$  To  $V_{OUT}$ ,  $\overline{V_{SHDN}} = V_{IN}$ , and device is MCP1790.

**Note:** Junction Temperature ( $T_J$ ) is approximated by soaking the device under test to an ambient temperature equal to the desired junction temperature. The test time is small enough such that the rise in Junction Temperature over the Ambient temperature is not significant.

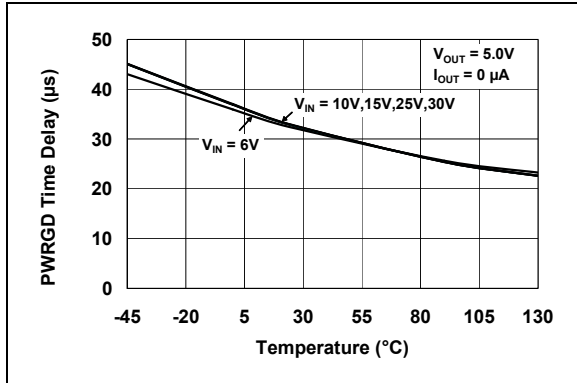

**FIGURE 2-1:** Power Good Time Delay vs. Temperature (MCP1791).

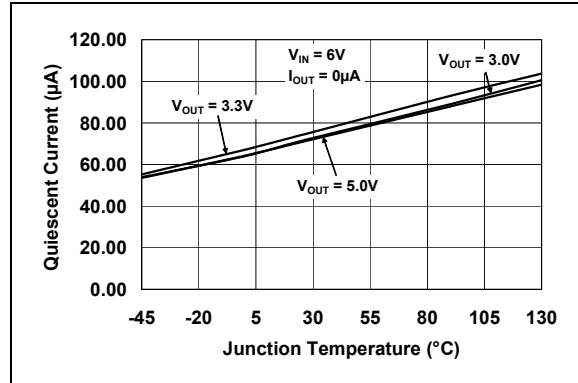

**FIGURE 2-4:** Quiescent Current vs. Junction Temperature.

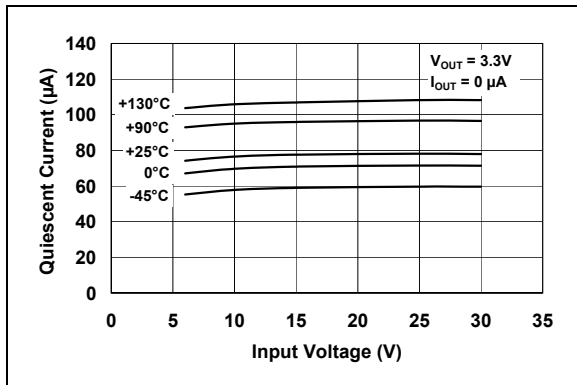

**FIGURE 2-2:** Quiescent Current vs. Input Voltage.

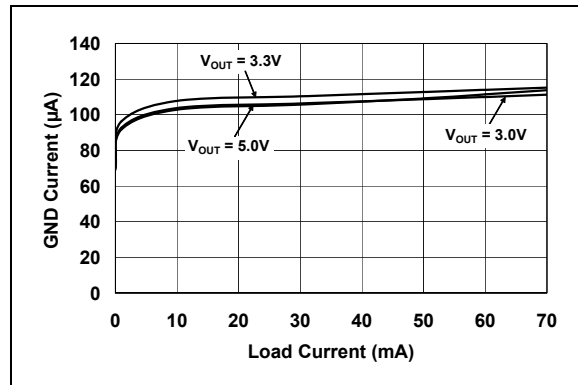

**FIGURE 2-5:** Ground Current vs. Load Current.

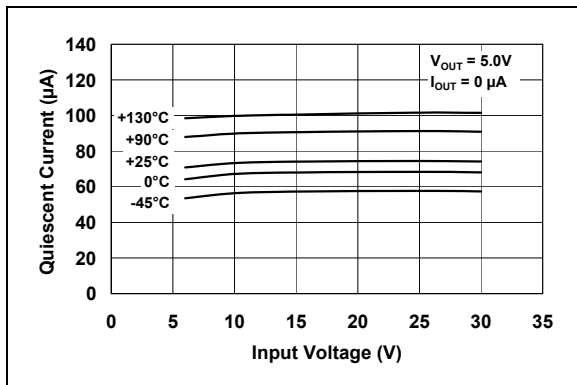

**FIGURE 2-3:** Quiescent Current vs. Input Voltage.

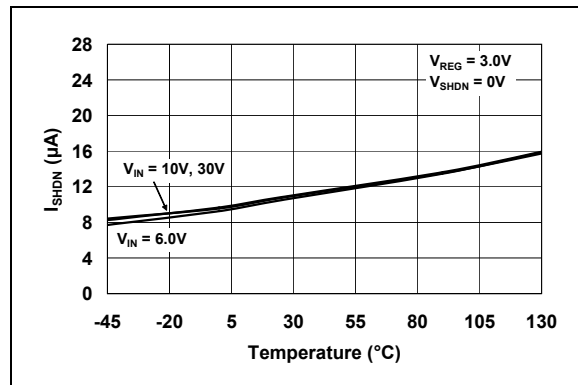
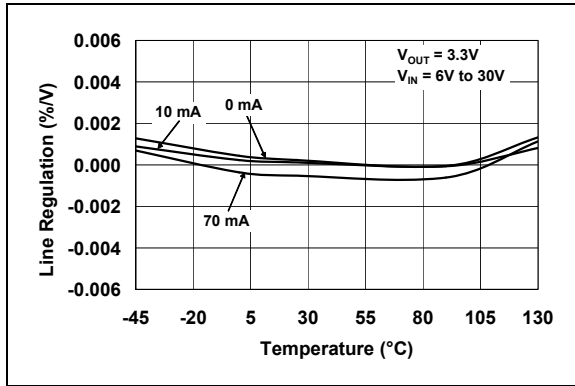

**FIGURE 2-6:**  $\overline{I_{SHDN}}$  vs Temperature.



# MCP1790/MCP1791

**Note:** Unless otherwise indicated,  $C_{OUT} = 4.7 \mu\text{F}$  Ceramic (X7R),  $C_{IN} = 10.0 \mu\text{F}$  Ceramic (X7R),  $I_{OUT} = 1 \text{ mA}$ , Temperature =  $+25^\circ\text{C}$ ,  $V_{IN} = 6.0\text{V}$ ,  $R_{PWRGD\_PULLUP} = 10 \text{ k}\Omega$  To  $V_{OUT}$ ,  $\overline{V}_{SHDN} = V_{IN}$ , and device is MCP1790.



**FIGURE 2-7:** Line Regulation vs. Temperature.

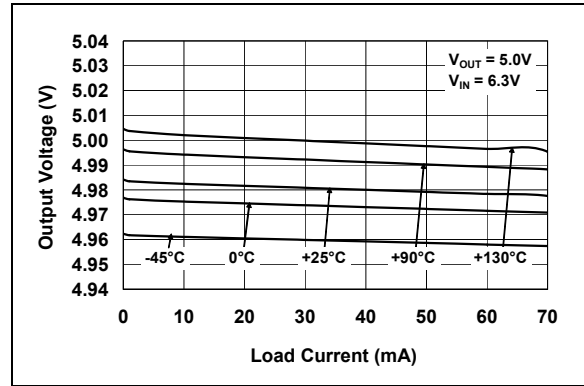

**FIGURE 2-10:** Output Voltage vs. Load Current.

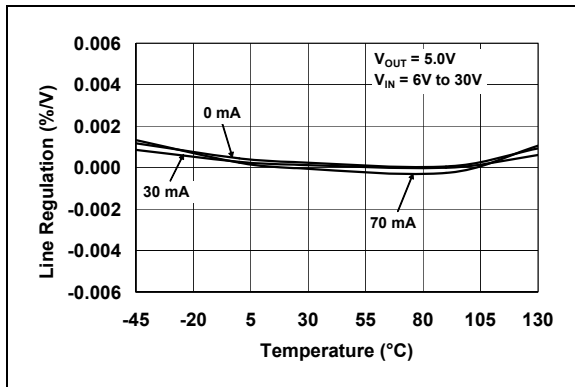

**FIGURE 2-8:** Line Regulation vs. Temperature.

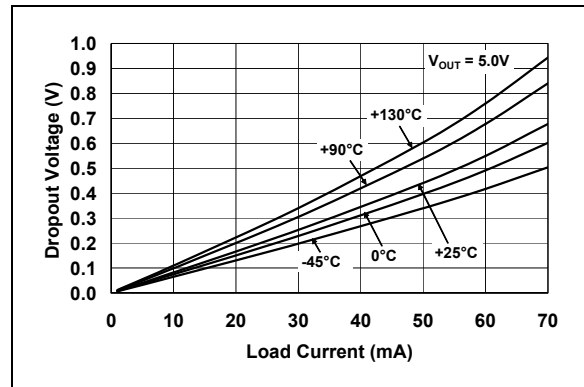

**FIGURE 2-11:** Dropout Voltage vs. Load Current.

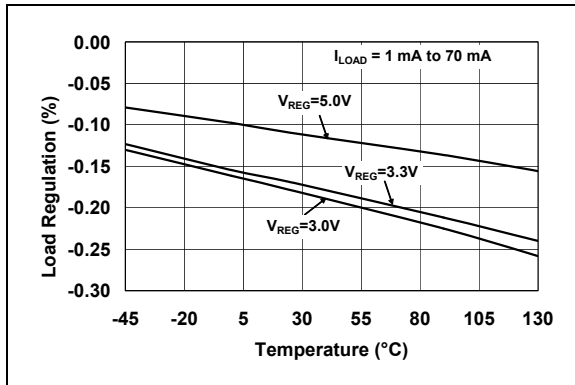

**FIGURE 2-9:** Load Regulation vs. Temperature.

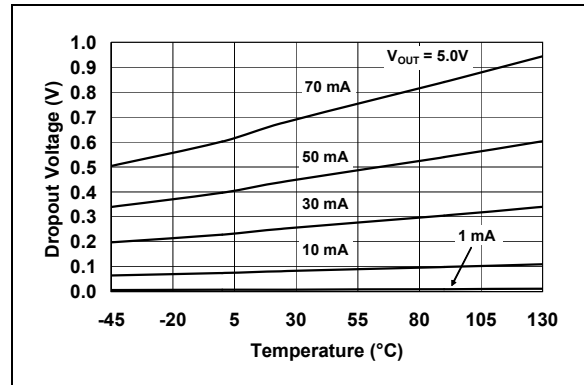

**FIGURE 2-12:** Dropout Voltage vs. Temperature.

# MCP1790/MCP1791

**Note:** Unless otherwise indicated,  $C_{OUT} = 4.7 \mu\text{F}$  Ceramic (X7R),  $C_{IN} = 10.0 \mu\text{F}$  Ceramic (X7R),  $I_{OUT} = 1 \text{ mA}$ , Temperature =  $+25^\circ\text{C}$ ,  $V_{IN} = 6.0\text{V}$ ,  $R_{PWRGD\_PULLUP} = 10 \text{ k}\Omega$  To  $V_{OUT}$ ,  $\overline{V}_{SHDN} = V_{IN}$ , and device is MCP1790.

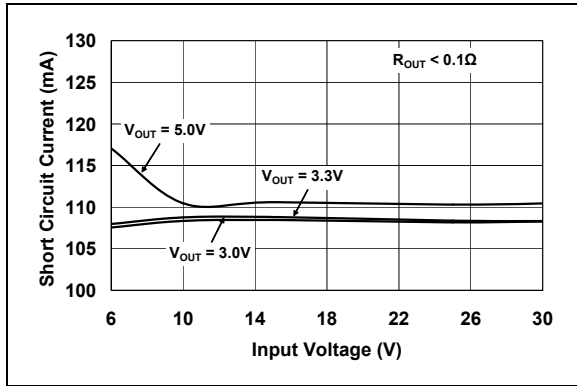

**FIGURE 2-13:** Short Circuit Current vs Input Voltage.

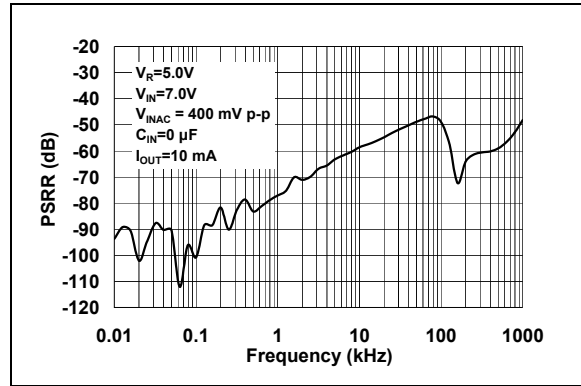

**FIGURE 2-16:** Power Supply Ripple Rejection vs. Frequency.

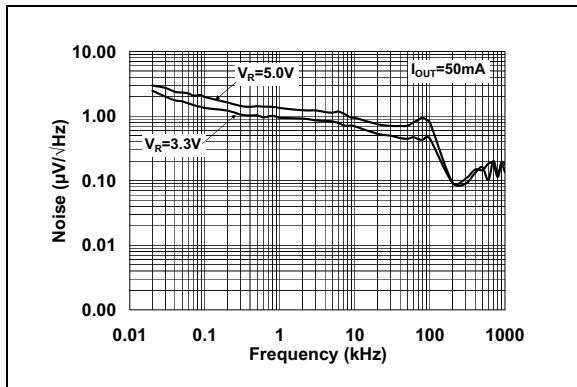

**FIGURE 2-14:** Output Noise Voltage Density vs. Frequency.

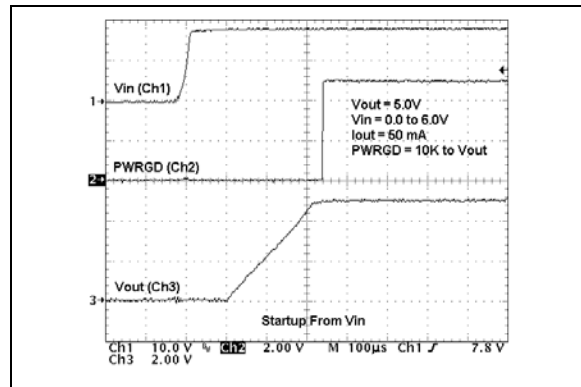

**FIGURE 2-17:** Startup from  $V_{IN}$  (MCP1791).

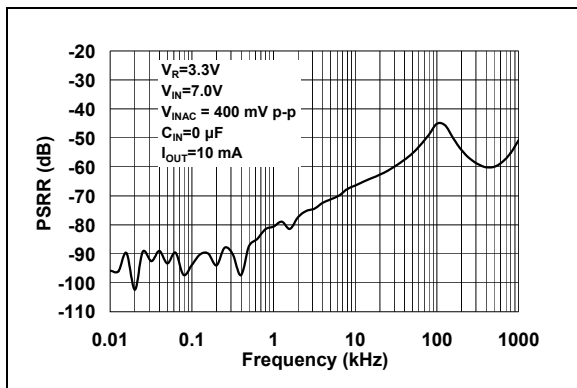

**FIGURE 2-15:** Power Supply Ripple Rejection vs. Frequency.

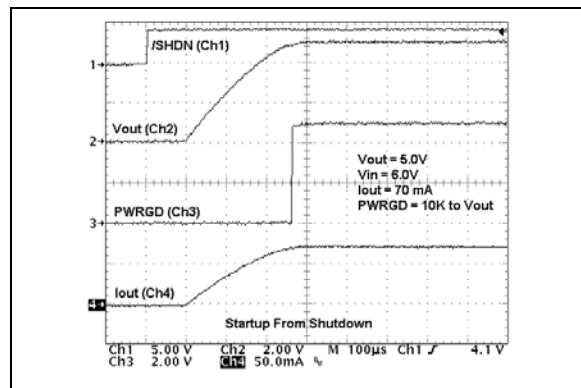

**FIGURE 2-18:** Startup from Shutdown (MCP1791).

# MCP1790/MCP1791

**Note:** Unless otherwise indicated,  $C_{OUT} = 4.7 \mu\text{F}$  Ceramic (X7R),  $C_{IN} = 10.0 \mu\text{F}$  Ceramic (X7R),  $I_{OUT} = 1 \text{ mA}$ , Temperature =  $+25^\circ\text{C}$ ,  $V_{IN} = 6.0\text{V}$ ,  $R_{PWRGD\_PULLUP} = 10 \text{ k}\Omega$  To  $V_{OUT}$ ,  $\overline{V_{SHDN}} = V_{IN}$ , and device is MCP1790.

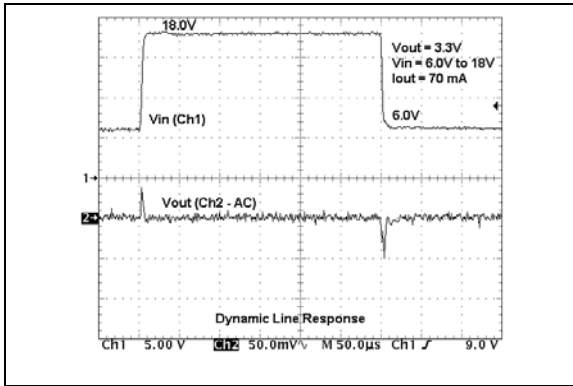

**FIGURE 2-19:** Dynamic Line Response.

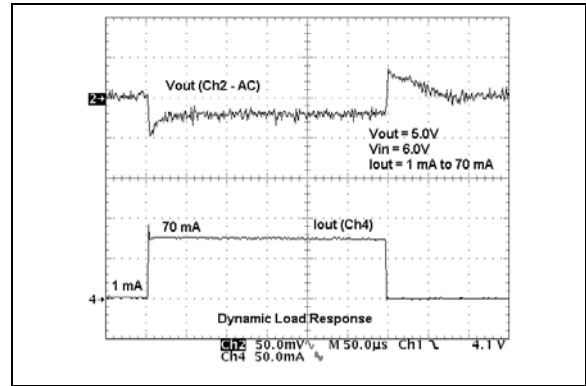

**FIGURE 2-22:** Dynamic Load Response.

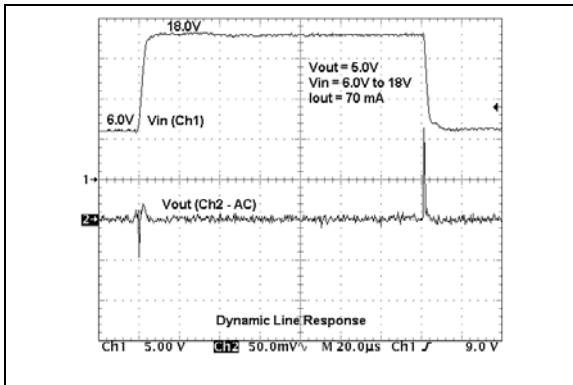

**FIGURE 2-20:** Dynamic Line Response.

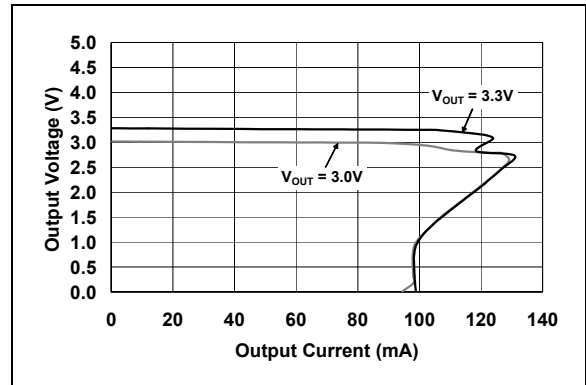

**FIGURE 2-23:** Short Circuit Response.

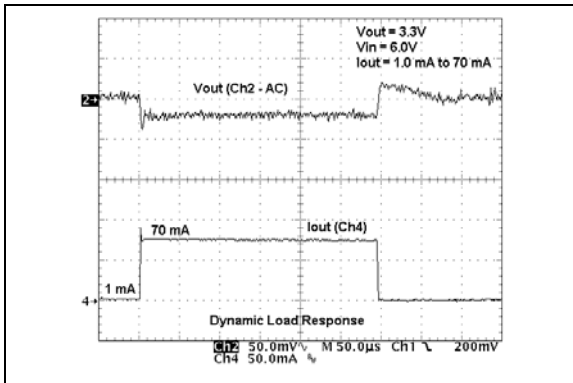

**FIGURE 2-21:** Dynamic Load Response.

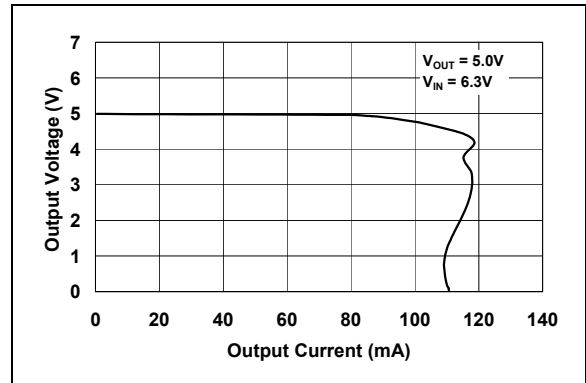

**FIGURE 2-24:** Short Circuit Response.

# MCP1790/MCP1791

**Note:** Unless otherwise indicated,  $C_{OUT} = 4.7 \mu\text{F}$  Ceramic (X7R),  $C_{IN} = 10.0 \mu\text{F}$  Ceramic (X7R),  $I_{OUT} = 1 \text{ mA}$ , Temperature =  $+25^\circ\text{C}$ ,  $V_{IN} = 6.0\text{V}$ ,  $R_{PWRGD\_PULLUP} = 10 \text{ k}\Omega$  To  $V_{OUT}$ ,  $\overline{V_{SHDN}} = V_{IN}$ , and device is MCP1790.

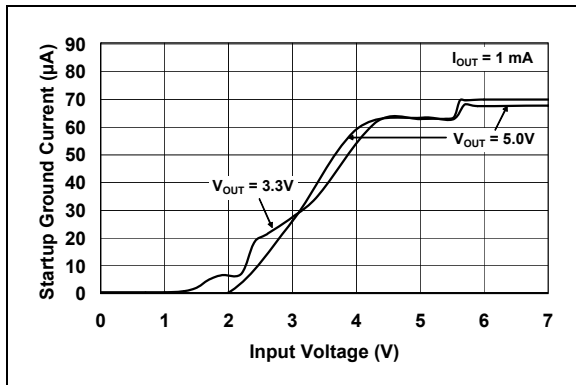

**FIGURE 2-25:** Startup Ground Current.

## 3.0 PIN DESCRIPTIONS

The descriptions of the pins are listed in [Table 3-1](#) and [Table 3-2](#).

**TABLE 3-1: MCP1790 PIN FUNCTION TABLE**

Pin No. SOT-223-3	Pin No. DDPAK-3	Symbol	Function
1	1	$V_{IN}$	Unregulated Supply Voltage
2, Tab	2, Tab	GND	Ground Terminal
3	3	$V_{OUT}$	Regulated Output Voltage

**TABLE 3-2: MCP1791 PIN FUNCTION TABLE**

Pin No. SOT-223-5	Pin No. DDPAK-5	Symbol	Function
1	1	$\overline{\text{SHDN}}$	Shutdown Input
2	2	$V_{IN}$	Unregulated Supply Voltage
3	3	GND	Ground Terminal
4	4	$V_{OUT}$	Regulated Output Voltage
5	5	PWRGD	Power Good Open-Drain Output
Tab	Tab	—	Connected to Ground
—	—	N/C	no connection

### 3.1 Input Voltage Supply ( $V_{IN}$ )

Connect the unregulated or regulated input voltage source to  $V_{IN}$ . If the input voltage source is located several inches away from the regulator or the input source is a battery, it is recommended that an input capacitor is used. A typical input capacitance value of 1  $\mu\text{F}$  to 10  $\mu\text{F}$  should be sufficient for most applications. The type of capacitor used can be ceramic, tantalum or aluminum electrolytic. The low ESR characteristics of the ceramic will yield better noise and PSRR performance at high-frequency.

### 3.2 Ground (GND)

Tie GND to the negative side of the output and the negative side of the input capacitor. Only the regulator bias current flows out of this pin; there is no high current. The regulator output regulation is referenced to this pin. Minimize voltage drops between this pin and the negative side of the load.

### 3.3 Regulated Output Voltage ( $V_{OUT}$ )

The  $V_{OUT}$  pin is the regulated output voltage of the regulator. A minimum output capacitance of 1.0  $\mu\text{F}$  tantalum, 1.0  $\mu\text{F}$  electrolytic, or 4.7  $\mu\text{F}$  ceramic is required for stability. The MCP1790 is stable with ceramic, tantalum, and electrolytic capacitors. See [Section 4.7 “Output Capacitor”](#) for output capacitor selection guidance.

### 3.4 Shutdown ( $\overline{\text{SHDN}}$ )

The  $\overline{\text{SHDN}}$  pin is an active-low input signal that turns the regulator output voltage on and off. When the  $\overline{\text{SHDN}}$  input is at a logic-high level, the regulator output voltage is enabled. When the  $\overline{\text{SHDN}}$  input is pulled to a logic-low level, the regulator output voltage is disabled. When the  $\overline{\text{SHDN}}$  input is pulled low, the PWRGD output signal also goes low and the regulator enters a low quiescent current shutdown state where the typical quiescent current is 10  $\mu\text{A}$ . The  $\overline{\text{SHDN}}$  pin is bonded to  $V_{IN}$  in the 3-pin versions of the regulator. See [Table 4-1](#).

### 3.5 Power Good Output (PWRGD)

The PWRGD pin is an open-drain output signal that is used to indicate when the regulator output voltage is within 90% (typically) of its nominal regulation value. The PWRGD threshold has a typical hysteresis value of 2%. The typical PWRGD delay time due to  $V_{OUT}$  rising above 90% +3% (maximum hysteresis) is 30  $\mu\text{s}$ . The typical PWRGD delay time due to  $V_{OUT}$  falling below 90% is 235  $\mu\text{s}$ . These delay times are internally fixed.

### 3.6 Exposed Pad (EP)

The DDPAK package has an exposed tab on the package. A heat sink may be mounted to the tab to aid in the removal of heat from the package during operation.

The exposed tab or pad of all of the available packages is at the ground potential of the regulator.

# MCP1790/MCP1791

## 4.0 DEVICE OVERVIEW

The MCP1790/MCP1791 are high input voltage regulators capable of providing up to 70 mA of current at output voltages up to 5.0V. The devices have an input voltage operating range from 6.0V to 30V, 48V absolute max. The MCP1790 devices are 3-pin devices consisting of  $V_{IN}$ ,  $V_{OUT}$ , and GND. The MCP1791 devices have 5 or more pins which add Shutdown and Power-Good functions to the MCP1790 device.

### 4.1 Startup

In the start phase, the device must see at least 6.0V to initiate operation during power up. In the Power-down mode, the  $V_{IN}$  monitor will be turned off.

### 4.2 Thermal Shutdown

The regulator has a thermal shutdown. If the thermal protection circuit detects an over temperature condition, typically 157°C junction temperature, the regulator will shut down. The device will recover from the thermal shutdown when the junction temperature drops to 137°C (typical).

### 4.3 Regulator Output Voltage

The MCP1790/MCP1791 regulators are available in fixed output voltage configurations. The standard output voltages are 3.0V, 3.3V, and 5.0V.

## 4.4 External Protection

### 4.4.1 TRANSIENT VOLTAGE PROTECTION (LOAD DUMP)

The regulator is capable of withstanding a 48V (43.5V  $\pm$ 10) load dump transient for a duration of 180 ms and a repetition rate of 30 seconds (ES-XW7T-1A278-AC, Ford Motor Company, Test Pulse G Loaded).

While not necessary, good design practice dictates adding an external transient suppressor, between  $V_{BB}$  and ground, with a low value resistor in series with the battery supply and the  $V_{IN}$  pin, to limit currents and voltages due to electrical transients. Because of the regulator startup current, the resistor value should be less than  $(V_{BAT} - 6V) / 200 \text{ mA}$ . For a 12V battery voltage, the resistor value should be less than 30 ohms.

### 4.4.2 REVERSE BATTERY PROTECTION

An external reverse battery blocking diode may be used to provide polarity protection.

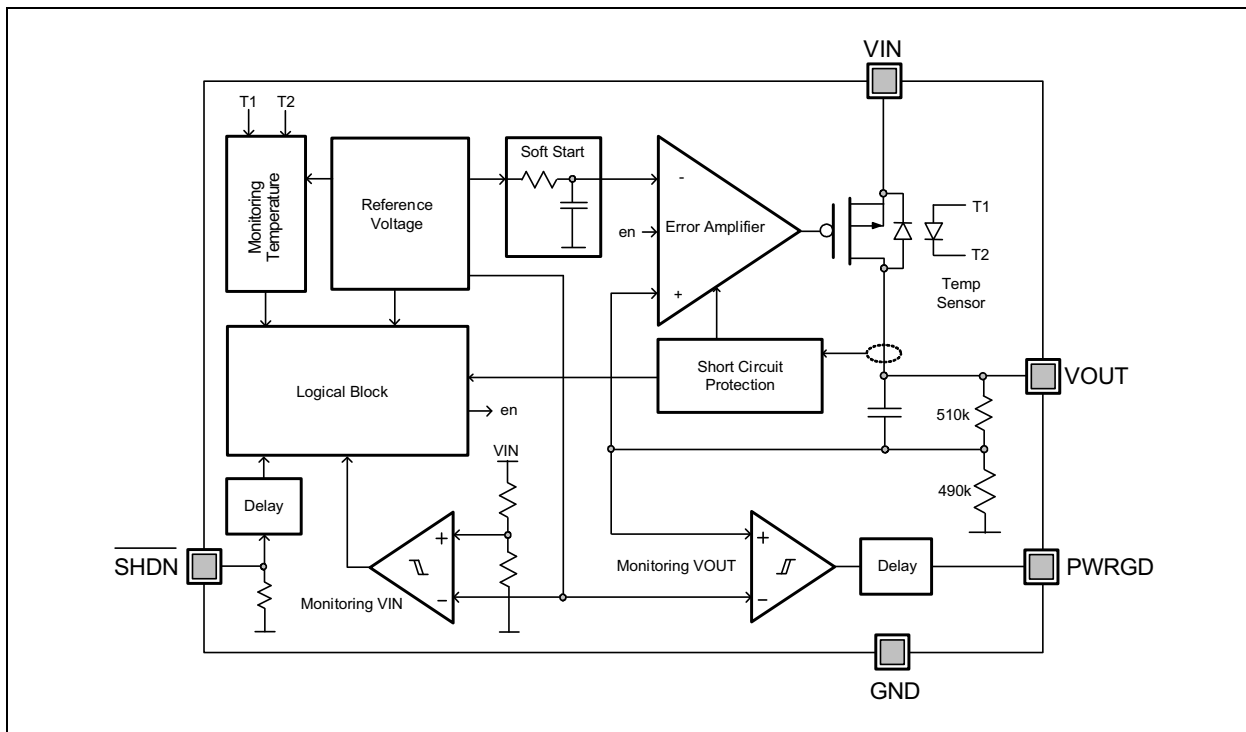

FIGURE 4-1: MCP1790/MCP1791 Block Diagram.

## 4.5 Shutdown ( $\overline{\text{SHDN}}$ )

The MCP1791 has a Shutdown ( $\overline{\text{SHDN}}$ ) input signal that enables or disables the regulator output voltage. When the  $\overline{\text{SHDN}}$  input signal is greater than 2.40V, the regulator output voltage is enabled. Note that the regulator output may still be disabled by the undervoltage lockout incorporated within the  $V_{\text{IN}}$  circuitry.

The value of the  $\overline{\text{SHDN}}$  signal to put the regulator into Shutdown mode is  $\leq 0.8\text{V}$ . The  $\overline{\text{SHDN}}$  pin is pulled low by an internal resistor. If the  $\overline{\text{SHDN}}$  pin is left floating, the internal pull-down resistor will put the regulator into shutdown mode.

When the  $\overline{\text{SHDN}}$  input signal is pulled to a logic-low, the PWRGD output signal will also go low and the regulator will enter a low quiescent current state where the typical quiescent current is 10  $\mu\text{A}$ . There is a short time delay (approximately 400 ns) when the  $\overline{\text{SHDN}}$  input signal transitions from high to low to prevent signal noise from disabling the regulator. The  $\overline{\text{SHDN}}$  pin will ignore low-going pulses that are up to 400 ns in pulse width. If the  $\overline{\text{SHDN}}$  input is pulled low for more than 400 ns, the regulator will enter Shutdown mode. This small bit of filtering helps to reject any system noise spikes on the  $\overline{\text{SHDN}}$  input signal.

On the rising edge of the  $\overline{\text{SHDN}}$  input, the shutdown circuitry will have a 100  $\mu\text{s}$  delay before allowing the regulator output to turn on. This delay helps to reject any false turn-on signals or noise on the  $\overline{\text{SHDN}}$  input signal. After the 100  $\mu\text{s}$  delay, the regulator will start charging the output capacitor as the regulator output voltage rises from 0V to its final regulated value. The charging current will be limited by the short circuit current value of the device. If the  $\overline{\text{SHDN}}$  input signal is pulled low during the 100  $\mu\text{s}$  delay period, the timer will be reset and the delay time will start over again on the next rising edge of the  $\overline{\text{SHDN}}$  input. The total time from the  $\overline{\text{SHDN}}$  input going high (turn-on) to the regulator output being in regulation shall typically be 200  $\mu\text{s}$  (100  $\mu\text{s}$  + 100  $\mu\text{s}$ ) for a  $C_{\text{LOAD}} = 1.0 \mu\text{F}$ .

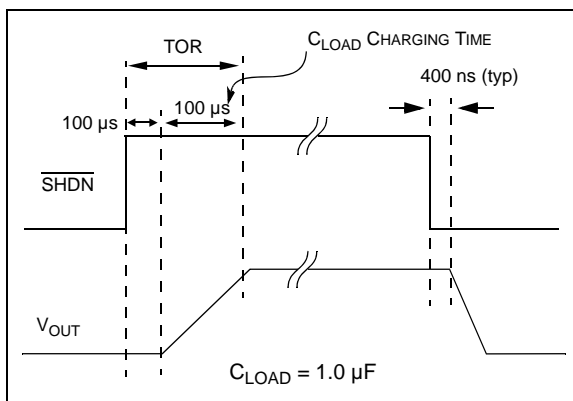

**FIGURE 4-2:** Shutdown Input Timing Diagram.

## 4.6 Low Voltage Shutdown

The MCP1790/MCP1791 incorporates a Low Voltage Shutdown circuit that turns off the output of the regulator whenever the input voltage,  $V_{\text{IN}}$ , is below the specified turn off voltage,  $V_{\text{OFF}}$ . When the input voltage ( $V_{\text{B}}$ ) drops below the differential needed to provide stable regulation, the output voltage ( $V_{\text{REG}}$ ) shall track the input down to approximately +4.00V. The regulator will turn off the output at this point.

The output will turn on when  $V_{\text{IN}}$  rises above the  $V_{\text{ON}}$  value specified in the data sheet. This feature is independent of the Shutdown input signal ( $\overline{\text{SHDN}}$ ) that is provided for external regulator control. If the  $\overline{\text{SHDN}}$  input signal is active (LOW), then the output of the regulator shall be disabled regardless of input voltage.

**TABLE 4-1: SHUTDOWN LOGIC**

$V_{\text{IN}}$	$\overline{\text{SHDN}}$	$V_{\text{OUT}}$
$< V_{\text{OFF}}$	L	OFF
$< V_{\text{OFF}}$	H	OFF
$> V_{\text{ON}}$	L	OFF
$> V_{\text{ON}}$	H	ON

## 4.7 Output Capacitor

The MCP1790/MCP1791 requires a minimum output capacitance of 1  $\mu\text{F}$  tantalum or electrolytic capacitance. The minimum value for ceramic capacitors is 4.7  $\mu\text{F}$ . The regulator is stable for all three types of capacitors from 4.7  $\mu\text{F}$  to 1000  $\mu\text{F}$  (see Figure 4-3). The MCP1790/MCP1791 regulator may be used with a 1  $\mu\text{F}$  ceramic output capacitor if a 0.300  $\Omega$  resistor is placed in series with the capacitor. The low ESR and corresponding pole of the ceramic capacitor causes the instability below 4.7  $\mu\text{F}$ .

The Equivalent Series Resistance (ESR) of the output capacitor must be no greater than 3 ohms. The output capacitor should be located as close to the regulator output as is practical. Ceramic materials X7R and X5R have low temperature coefficients and are recommended because of their size, cost, and environmental robustness qualities.

# MCP1790/MCP1791

## 4.8 Output Current and Current Limiting

The MCP1790/MCP1791 devices are tested and ensured to supply a minimum of 70 mA of output current.

The MCP1790/MCP1791 also incorporate an output current limit foldback. When the regulator is in an overcurrent condition,  $V_{OUT}$  will decrease with increasing load. When  $V_{OUT}$  falls below 30% (typical) of  $V_R$ , the output current will start to fold back. The output current will fold back to less than 100 mA (typical) when  $V_{OUT}$  is near 0 volts.

The 5.0V regulator has an overload current limiting of approximately 120 mA. If  $V_{REG}$  is lower than 3.5V,  $I_{OUT}$  will start to fold back and decrease along with  $V_{REG}$  until  $I_{OUT}$  is less than 105 mA and  $V_{REG}$  is near 0 volts.

The 3.3V regulator has an overload current limiting of approximately 130 mA. If  $V_{REG}$  is lower than 2.5V,  $I_{OUT}$  will start to fold back and decrease along with  $V_{REG}$  until  $I_{OUT}$  is less than 99 mA and  $V_{REG}$  is near 0 volts.

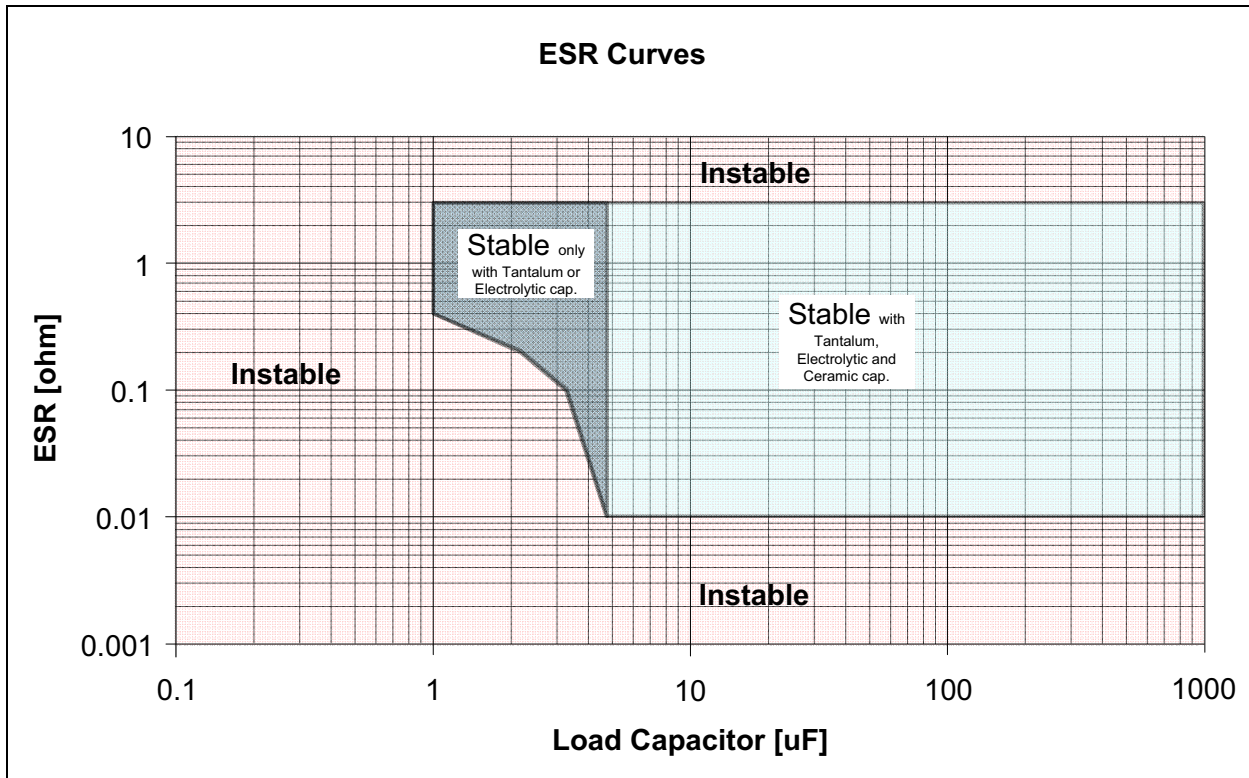

FIGURE 4-3: ESR Curves For Load Capacitor Selection.



## 4.9 Power Good Output (PWRGD)

The MCP1791 has an open-drain Power Good (PWRGD) output signal capable of sinking a minimum of 5.0 mA of current while maintaining a PWRGD output voltage of 0.4V or less.

As the output voltage of the LDO rises, the PWRGD output will be held low until the output voltage has exceeded the power good threshold ( $V_{PWRGD\_TH}$ ) level by an amount equal to the power good hysteresis value ( $V_{PWRGD\_HYS}$ ), typically 2% of  $V_R$ . Once this threshold has been exceeded, the power good output signal will be pulled high by an external pull-up resistor, indicating that the output voltage is stable and within regulation limits.

If the output voltage of the LDO falls below the power good threshold ( $V_{PWRGD\_TH}$ ) level, the power good output will transition low. The power good circuitry has a 235  $\mu\text{s}$  delay when detecting a falling output voltage, which helps to increase noise immunity of the power good output and avoid false triggering of the power good output during fast output transients. See Figure 4-4 for power good timing characteristics.

When the LDO is put into Shutdown mode using the SHDN input, the power good output is pulled low within 400 ns typical, indicating that the output voltage will be out of regulation. The timing diagram for the power good output when using the shutdown input is shown in Figure 4-5.

The PWRGD output may be pulled up to either  $V_{IN}$  or  $V_{OUT}$ . When pulled to  $V_{OUT}$ , the PWRGD output will sink very little current during shutdown. When PWRGD is pulled up to  $V_{IN}$ , the PWRGD output will sink current during shutdown. That is because  $V_{OUT}$  is 0 during shutdown while  $V_{IN}$  is still active. When the PWRGD output is pulled to  $V_{IN}$ , the PWRGD output signal will track  $V_{IN}$  at startup until the threshold of the PWRGD circuitry has been reached and the PWRGD circuitry pulls the signal back low. Therefore, when pulling PWRGD to  $V_{IN}$  instead of  $V_{OUT}$ , the designer must be aware of the PWRGD signal going high while the input voltage is rising at startup. Pulling PWRGD to  $V_{OUT}$  removes the startup pulse.

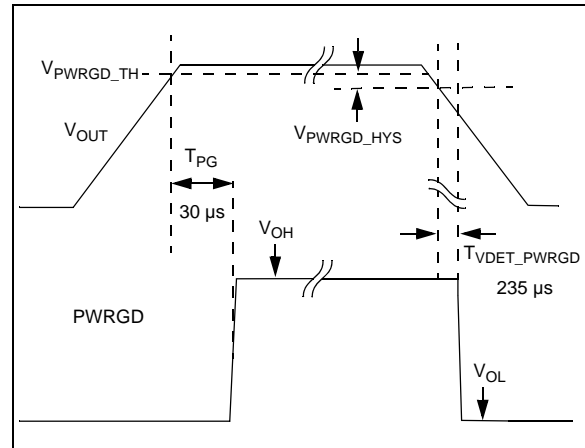

**FIGURE 4-4:** Power Good Timing.

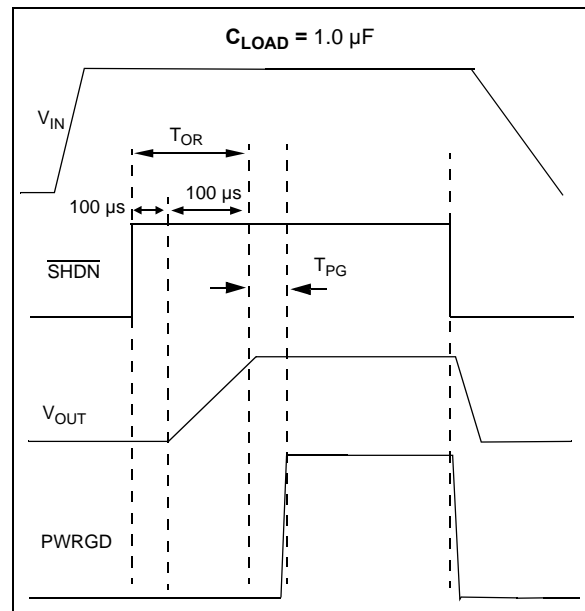

**FIGURE 4-5:** Power Good Timing from Shutdown.

# MCP1790/MCP1791

## 5.0 APPLICATION CIRCUITS / ISSUES

### 5.1 Typical Application

The MCP1790/MCP1791 is most commonly used as a voltage regulator. It's high voltage input capability and thermal protection make it ideal for automotive and 24V industrial applications.

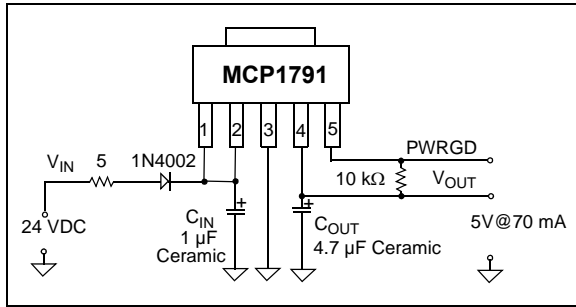

**FIGURE 5-1:** Typical Application.

#### 5.1.1 APPLICATION INPUT CONDITIONS

- Package Type = SOT-223-5
- Input Voltage Range = 8V to 24V
- $V_{IN}$  maximum = 24V
- $V_{OUT}$  typical = 5.0V
- $I_{OUT}$  = 70 mA maximum

## 5.2 Power Calculations

### 5.2.1 POWER DISSIPATION

The internal power dissipation of the MCP1790/MCP1791 is a function of input voltage, output voltage and output current. The power dissipation, as a result of the quiescent current draw, is so low, it is insignificant ( $70.0 \mu A \times V_{IN}$ ). The following equation can be used to calculate the internal power dissipation of the LDO.

#### EQUATION 5-1:

$$P_{LDO} = (V_{IN(MAX)} - V_{OUT(MIN)}) \times I_{OUT(MAX)}$$

$P_{LDO}$  = LDO Pass device internal power dissipation

$V_{IN(MAX)}$  = Maximum input voltage

$V_{OUT(MIN)}$  = LDO minimum output voltage

The maximum continuous operating junction temperature specified for the MCP1790/MCP1791 is +125°C. To estimate the internal junction temperature of the MCP1790/MCP1791, the total internal power dissipation is multiplied by the thermal resistance from junction to ambient ( $R\theta_{JA}$ ). The thermal resistance from junction to ambient for the SOT-223-5 package is estimated at 62°C/W.

#### EQUATION 5-2:

$$T_{J(MAX)} = P_{TOTAL} \times R\theta_{JA} + T_{AMAX}$$

$T_{J(MAX)}$  = Maximum continuous junction temperature.

$P_{TOTAL}$  = Total device power dissipation.

$R\theta_{JA}$  = Thermal resistance from junction to ambient.

$T_{AMAX}$  = Maximum ambient temperature.

The maximum power dissipation capability for a package can be calculated given the junction-to-ambient thermal resistance and the maximum ambient temperature for the application. The following equation can be used to determine the package maximum internal power dissipation.

#### EQUATION 5-3:

$$P_{D(MAX)} = \frac{(T_{J(MAX)} - T_{A(MAX)})}{R\theta_{JA}}$$

$P_{D(MAX)}$  = Maximum device power dissipation.

$T_{J(MAX)}$  = Maximum continuous junction temperature.

$T_{A(MAX)}$  = Maximum ambient temperature.

$R\theta_{JA}$  = Thermal resistance from junction to ambient.

#### EQUATION 5-4:

$$T_{J(RISE)} = P_{D(MAX)} \times R\theta_{JA}$$

$T_{J(RISE)}$  = Rise in device junction temperature over the ambient temperature.

$P_{TOTAL}$  = Maximum device power dissipation.

$R\theta_{JA}$  = Thermal resistance from junction-to-ambient.

#### EQUATION 5-5:

$$T_J = T_{J(RISE)} + T_A$$

$T_J$  = Junction Temperature.

$T_{J(RISE)}$  = Rise in device junction temperature over the ambient temperature.

$T_A$  = Ambient temperature.

## 5.3 Power Dissipation Example

Internal power dissipation, junction temperature rise, junction temperature and maximum power dissipation are calculated in the following example. The power dissipation, as a result of ground current, is small enough to be neglected.

### 5.3.1 POWER DISSIPATION EXAMPLE

#### Package:

Package Type = SOT-223-5

#### Input Voltage:

$$V_{IN} = 8V \text{ to } 24V$$

#### LDO Output Voltages and Currents:

$$V_{OUT} = 5.0V$$

$$I_{OUT} = 50 \text{ mA}$$

#### Maximum Ambient Temperature:

$$T_{A(MAX)} = +40^{\circ}C$$

#### Internal Power Dissipation:

Internal Power dissipation is the product of the LDO output current times the voltage across the LDO ( $V_{IN}$  to  $V_{OUT}$ ).

$$P_{LDO(MAX)} = (V_{IN(MAX)} - V_{OUT(MIN)}) \times I_{OUT(MAX)}$$

$$P_{LDO} = (24V - (0.98 \times 5.0V)) \times 50 \text{ mA}$$

$$P_{LDO} = 955 \text{ milli-Watts}$$

#### 5.3.1.1 Device Junction Temperature Rise

The internal junction temperature rise is a function of internal power dissipation and the thermal resistance from junction to ambient for the application. The thermal resistance from junction to ambient ( $R_{\theta JA}$ ) is derived from an EIA/JEDEC standard for measuring thermal resistance for small surface mount packages. The EIA/JEDEC specification is JESD51-7, "High Effective Thermal Conductivity Test Board for Leaded Surface Mount Packages". The standard describes the test method and board specifications for measuring the thermal resistance from junction to ambient. The actual thermal resistance for a particular application can vary depending on many factors, such as copper area and thickness. Refer to AN792, "A Method to Determine How Much Power a SOT23 Can Dissipate in an Application", (DS00792), for more information regarding this subject.

$$T_{J(RISE)} = P_{TOTAL} \times R_{qJA}$$

$$T_{J(RISE)} = 955 \text{ milli-Watts} \times 62^{\circ}C/Watt$$

$$T_{J(RISE)} = 59.2^{\circ}C$$

#### 5.3.1.2 Junction Temperature Estimate

To estimate the internal junction temperature, the calculated temperature rise is added to the ambient or offset temperature. For this example, the worst-case junction temperature is estimated below.

$$T_J = T_{J(RISE)} + T_{A(MAX)}$$

$$T_J = 99.2^{\circ}C$$

#### 5.3.1.3 Maximum Package Power Dissipation at +40°C Ambient Temperature

SOT-223-5 ( $62^{\circ}C/Watt = R_{\theta JA}$ )

$$P_{D(MAX)} = (125^{\circ}C - 40^{\circ}C) / 62^{\circ}C/W$$

$$P_{D(MAX)} = 1.371 \text{ Watts}$$

DDPAK-5 ( $32^{\circ}C/Watt = R_{\theta JA}$ )

$$P_{D(MAX)} = (125^{\circ}C - 40^{\circ}C) / 32^{\circ}C/W$$

$$P_{D(MAX)} = 2.656 \text{ Watts}$$

## 5.4 Pulsed Load Applications

For some applications, there are pulsed load current events that may exceed the specified 70 mA maximum specification of the MCP1790/MCP1791. The internal current foldback feature of the MCP1790/MCP1791 will prevent high peak load demands from causing non-recoverable damage. The Current Foldback feature of the device will limit the output voltage and output current during pulsed applications. As the current rises above the foldback current threshold, the output voltage will decrease.

# MCP1790/MCP1791

## 6.0 PACKAGING INFORMATION

### 6.1 Package Marking Information

#### 3-Lead DDPAK (MCP1790)

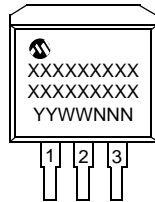

#### Example:

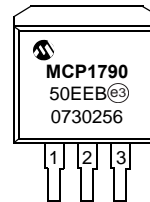

#### 3-Lead SOT-223 (MCP1790)

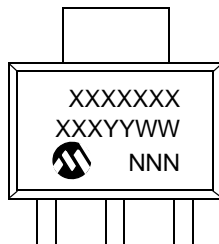

#### Example:

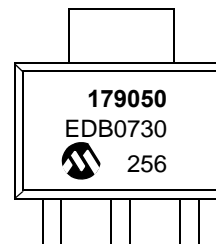

<b>Legend:</b>	XX...X	Customer-specific information
	Y	Year code (last digit of calendar year)
	YY	Year code (last 2 digits of calendar year)
	WW	Week code (week of January 1 is week '01')
	NNN	Alphanumeric traceability code
	Ⓔ3	Pb-free JEDEC designator for Matte Tin (Sn)
	*	This package is Pb-free. The Pb-free JEDEC designator (Ⓔ3) can be found on the outer packaging for this package.

**Note:** In the event the full Microchip part number cannot be marked on one line, it will be carried over to the next line, thus limiting the number of available characters for customer-specific information.

## 6.1 Package Marking Information (Continued)

### 5-Lead DDPAK (Fixed) (MCP1791)

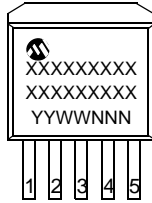

### Example:

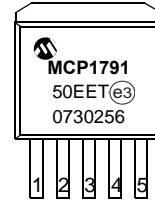

### 5-Lead SOT-223 (MCP1791)

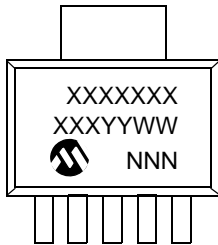

### Example:

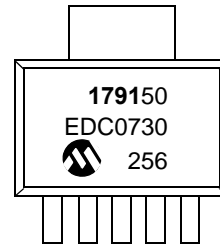

<b>Legend:</b>	XX...X	Customer-specific information
	Y	Year code (last digit of calendar year)
	YY	Year code (last 2 digits of calendar year)
	WW	Week code (week of January 1 is week '01')
	NNN	Alphanumeric traceability code
	(e3)	Pb-free JEDEC designator for Matte Tin (Sn)
	*	This package is Pb-free. The Pb-free JEDEC designator (e3) can be found on the outer packaging for this package.

**Note:** In the event the full Microchip part number cannot be marked on one line, it will be carried over to the next line, thus limiting the number of available characters for customer-specific information.

# MCP1790/MCP1791

## 3-Lead Plastic (EB) [DDPAK]

**Note:** For the most current package drawings, please see the Microchip Packaging Specification located at <http://www.microchip.com/packaging>

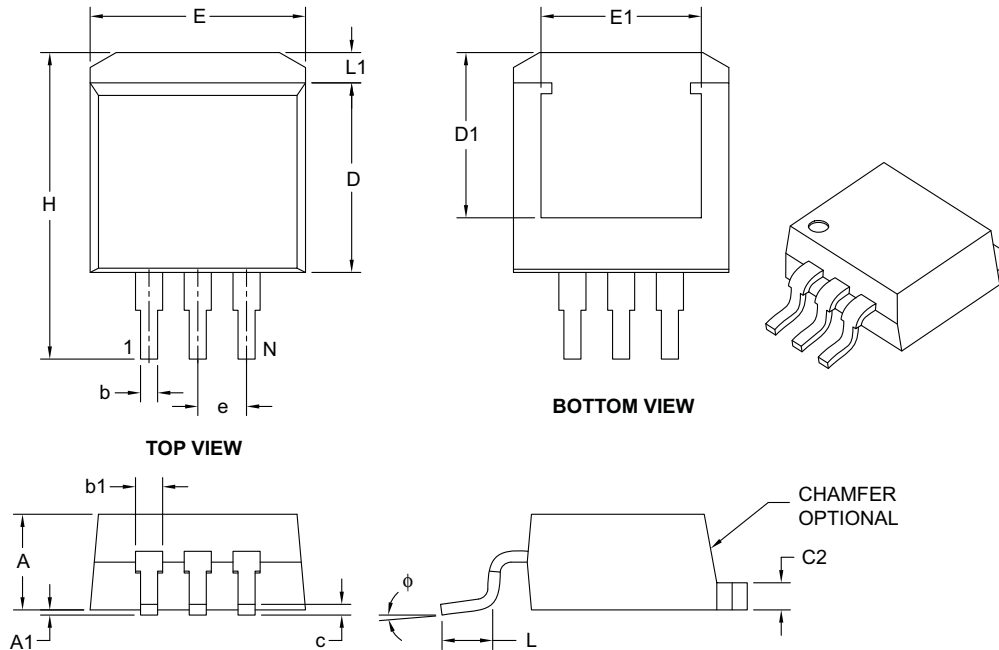

Dimension Limits	Units	INCHES		
		MIN	NOM	MAX
Number of Pins	N	3		
Pitch	e	.100 BSC		
Overall Height	A	.160	–	.190
Standoff §	A1	.000	–	.010
Overall Width	E	.380	–	.420
Exposed Pad Width	E1	.245	–	–
Molded Package Length	D	.330	–	.380
Overall Length	H	.549	–	.625
Exposed Pad Length	D1	.270	–	–
Lead Thickness	c	.014	–	.029
Pad Thickness	C2	.045	–	.065
Lower Lead Width	b	.020	–	.039
Upper Lead Width	b1	.045	–	.070
Foot Length	L	.068	–	.110
Pad Length	L1	–	–	.067
Foot Angle	φ	0°	–	8°

**Notes:**

- § Significant Characteristic.
- Dimensions D and E do not include mold flash or protrusions. Mold flash or protrusions shall not exceed .005" per side.
- Dimensioning and tolerancing per ASME Y14.5M.

BSC: Basic Dimension. Theoretically exact value shown without tolerances.

Microchip Technology Drawing C04-011B

# MCP1790/MCP1791

## 3-Lead Plastic Small Outline Transistor (DB) [SOT-223]

**Note:** For the most current package drawings, please see the Microchip Packaging Specification located at <http://www.microchip.com/packaging>

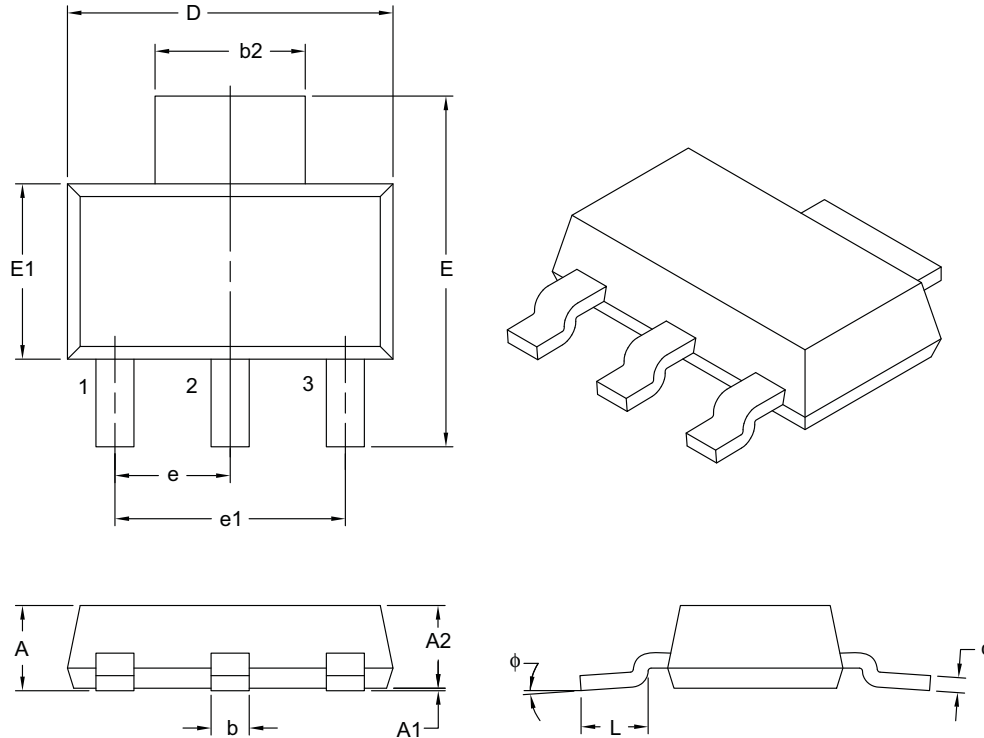

Dimension Limits	Units	MILLIMETERS		
		MIN	NOM	MAX
Number of Leads	N	3		
Lead Pitch	e	2.30 BSC		
Outside Lead Pitch	e1	4.60 BSC		
Overall Height	A	–	–	1.80
Standoff	A1	0.02	–	0.10
Molded Package Height	A2	1.50	1.60	1.70
Overall Width	E	6.70	7.00	7.30
Molded Package Width	E1	3.30	3.50	3.70
Overall Length	D	6.30	6.50	6.70
Lead Thickness	c	0.23	0.30	0.35
Lead Width	b	0.60	0.76	0.84
Tab Lead Width	b2	2.90	3.00	3.10
Foot Length	L	0.75	–	–
Lead Angle	$\phi$	0°	–	10°

**Notes:**

- Dimensions D and E1 do not include mold flash or protrusions. Mold flash or protrusions shall not exceed 0.127 mm per side.
- Dimensioning and tolerancing per ASME Y14.5M.

BSC: Basic Dimension. Theoretically exact value shown without tolerances.

Microchip Technology Drawing C04-032B

# MCP1790/MCP1791

## 3-Lead Plastic Small Outline Transistor (DB) [SOT-223]

**Note:** For the most current package drawings, please see the Microchip Packaging Specification located at <http://www.microchip.com/packaging>

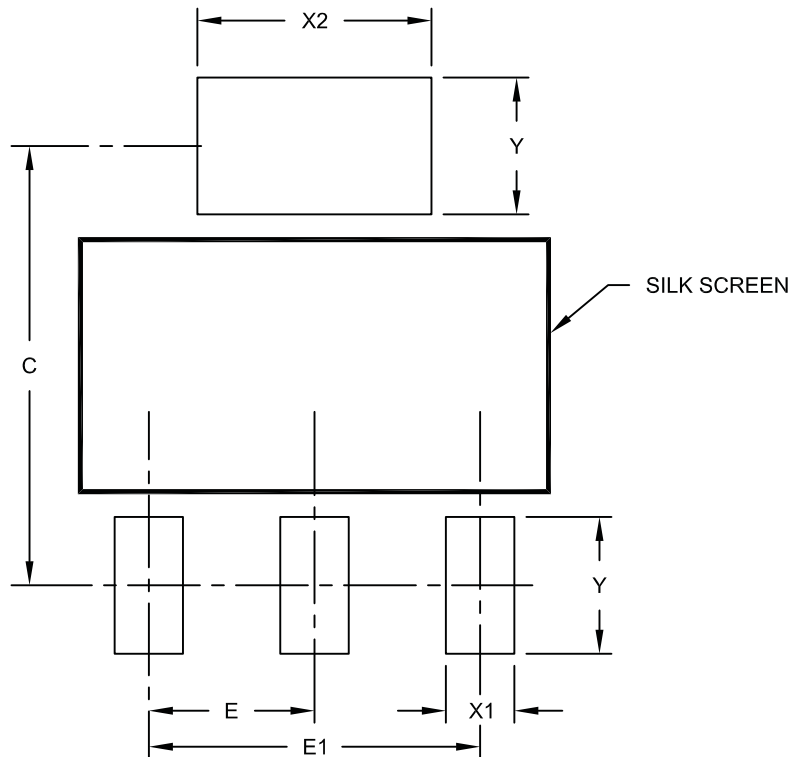

RECOMMENDED LAND PATTERN

Dimension Limits	Units	MILLIMETERS		
		MIN	NOM	MAX
Contact Pitch	E	2.30 BSC		
Overall Pitch	E1	4.60 BSC		
Contact Pad Spacing	C		6.10	
Contact Pad Width	X1			0.95
Contact Pad Width	X2			3.25
Contact Pad Length	Y			1.90

**Notes:**

1. Dimensioning and tolerancing per ASME Y14.5M

BSC: Basic Dimension. Theoretically exact value shown without tolerances.

Microchip Technology Drawing No. C04-2032A



# MCP1790/MCP1791

## 5-Lead Plastic (ET) [DDPAK]

**Note:** For the most current package drawings, please see the Microchip Packaging Specification located at <http://www.microchip.com/packaging>

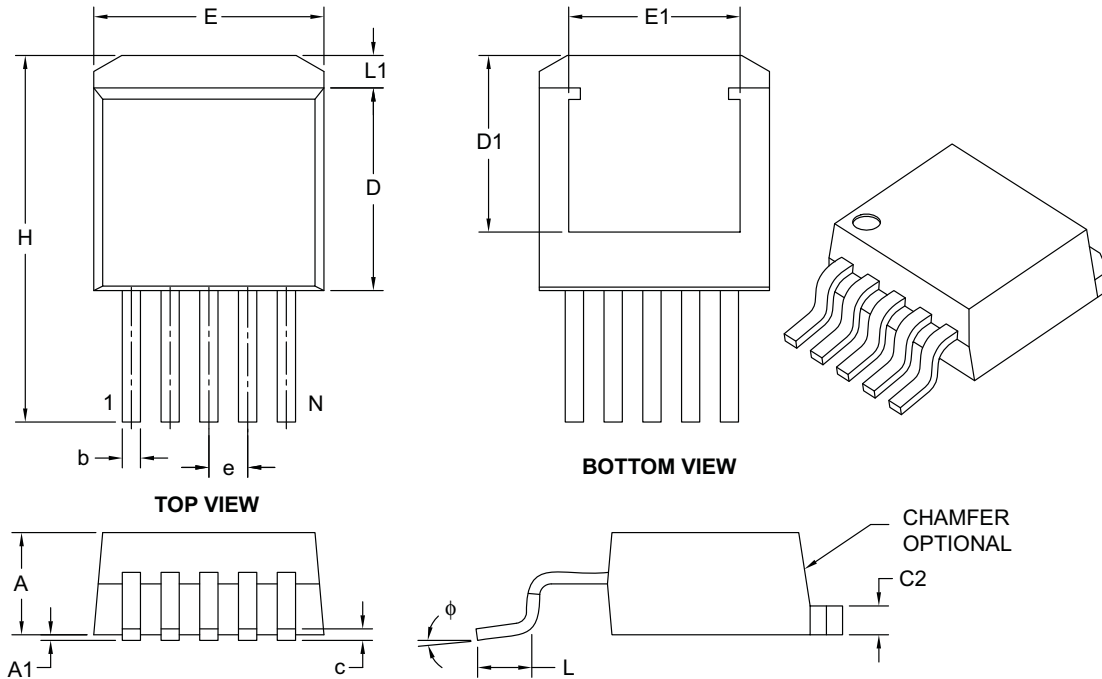

Dimension Limits	Units	INCHES		
		MIN	NOM	MAX
Number of Pins	N	5		
Pitch	e	.067 BSC		
Overall Height	A	.160	–	.190
Standoff §	A1	.000	–	.010
Overall Width	E	.380	–	.420
Exposed Pad Width	E1	.245	–	–
Molded Package Length	D	.330	–	.380
Overall Length	H	.549	–	.625
Exposed Pad Length	D1	.270	–	–
Lead Thickness	c	.014	–	.029
Pad Thickness	C2	.045	–	.065
Lead Width	b	.020	–	.039
Foot Length	L	.068	–	.110
Pad Length	L1	–	–	.067
Foot Angle	φ	0°	–	8°

**Notes:**

- § Significant Characteristic.
- Dimensions D and E do not include mold flash or protrusions. Mold flash or protrusions shall not exceed .005" per side.
- Dimensioning and tolerancing per ASME Y14.5M.

BSC: Basic Dimension. Theoretically exact value shown without tolerances.

Microchip Technology Drawing C04-012B

# MCP1790/MCP1791

## 5-Lead Plastic Small Outline Transistor (DC) [SOT-223]

**Note:** For the most current package drawings, please see the Microchip Packaging Specification located at <http://www.microchip.com/packaging>

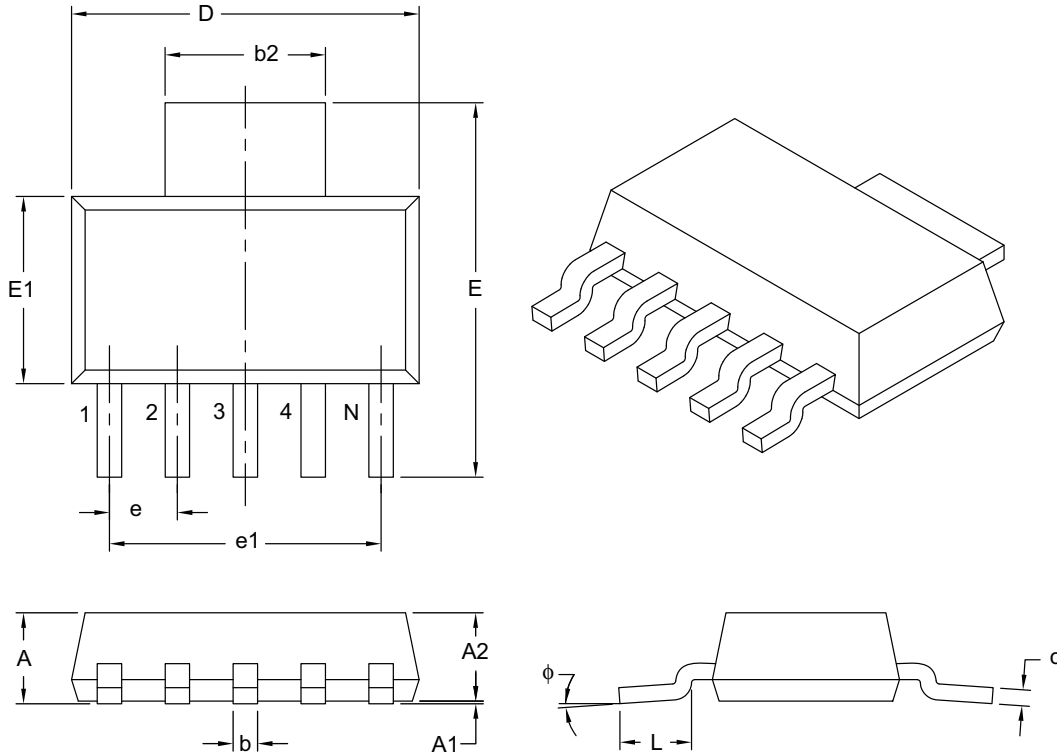

Dimension Limits	Units	MILLIMETERS		
		MIN	NOM	MAX
Number of Leads	N	5		
Lead Pitch	e	1.27 BSC		
Outside Lead Pitch	e1	5.08 BSC		
Overall Height	A	–	–	1.80
Standoff	A1	0.02	0.06	0.10
Molded Package Height	A2	1.55	1.60	1.65
Overall Width	E	6.86	7.00	7.26
Molded Package Width	E1	3.45	3.50	3.55
Overall Length	D	6.45	6.50	6.55
Lead Thickness	c	0.24	0.28	0.32
Lead Width	b	0.41	0.457	0.51
Tab Lead Width	b2	2.95	3.00	3.05
Foot Length	L	0.91	–	1.14
Lead Angle	$\phi$	0°	4°	8°

**Notes:**

- Dimensions D and E1 do not include mold flash or protrusions. Mold flash or protrusions shall not exceed 0.127 mm per side.
- Dimensioning and tolerancing per ASME Y14.5M.

BSC: Basic Dimension. Theoretically exact value shown without tolerances.

Microchip Technology Drawing C04-137B

## 5-Lead Plastic Small Outline Transistor (DC) [SOT-223]

**Note:** For the most current package drawings, please see the Microchip Packaging Specification located at <http://www.microchip.com/packaging>

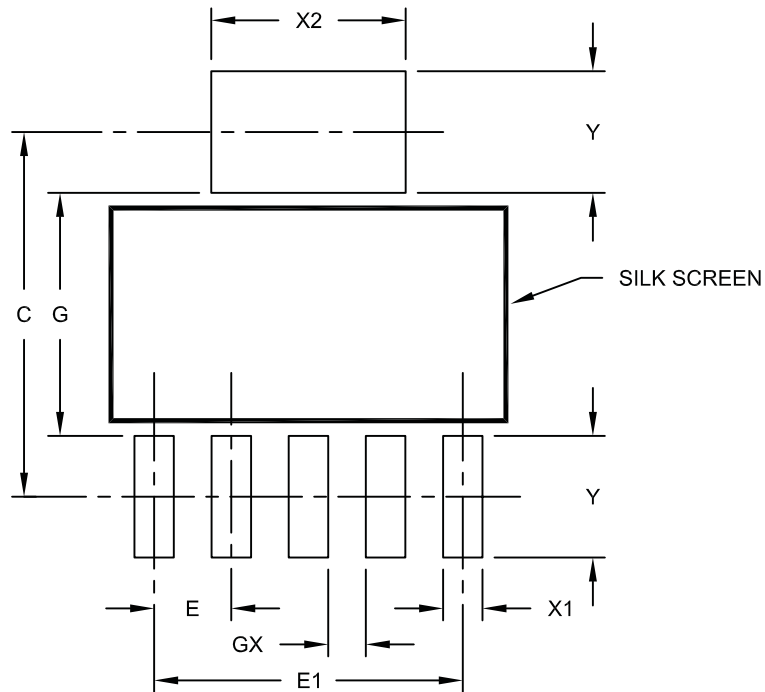

RECOMMENDED LAND PATTERN

Dimension Limits	Units	MILLIMETERS		
		MIN	NOM	MAX
Pad Pitch	E	1.27 BSC		
Overall Pad Pitch	E1	5.08 BSC		
Pad Spacing	C	6.00		
Pad Width	X1			0.65
Pad Width	X2			3.20
Pad Length	Y			2.00
Distance Between Pads	G	4.00		
Distance Between Pads	GX	0.62		

Notes:

1. Dimensioning and tolerancing per ASME Y14.5M

BSC: Basic Dimension. Theoretically exact value shown without tolerances.

Microchip Technology Drawing No. C04-2137A

# MCP1790/MCP1791

---

NOTES:

## APPENDIX A: REVISION HISTORY

### Revision A (March 2008)

- Original Release of this Document.

# MCP1790/MCP1791

---

NOTES:

# MCP1790/MCP1791

## PRODUCT IDENTIFICATION SYSTEM

To order or obtain information, e.g., on pricing or delivery, refer to the factory or the listed sales office.

<b>PART NO.</b>	<b>XX</b>	<b>X</b>	<b>X</b>	<b>X/</b>	<b>XX</b>
<b>Device</b>	<b>Output Voltage</b>	<b>Feature Code</b>	<b>Tolerance</b>	<b>Temp.</b>	<b>Package</b>
Device:	MCP1790:	70 mA High Voltage Regulator			
	MCP1790T:	70 mA High Voltage Regulator Tape and Reel			
	MCP1791:	70 mA High Voltage Regulator			
	MCP1791T:	70 mA High Voltage Regulator Tape and Reel			
Output Voltage *:	30	= 3.0V "Standard"			
	33	= 3.3V "Standard"			
	50	= 5.0V "Standard"			
		*Contact factory for other output voltage options			
Extra Feature Code:	0	= Fixed			
Tolerance:	2	= 2.5% (Standard)			
Temperature:	E	= -40°C to +125°C			
Package Type:	EB	= Plastic, DDPAK, 3-lead			
	ET	= Plastic, DDPAK, 5-lead			
	DB	= Plastic Transistor Outline, SOT-223, 3-lead			
	DC	= Plastic Transistor Outline, SOT-223, 5-lead			

<b>Examples:</b>	
a)	MCP1790-3002E/EB: 3.0V LDO Regulator, 3LD DDPAK
b)	MCP1790-3302E/EB: 3.3V LDO Regulator, 3LD DDPAK
c)	MCP1790-5002E/EB: 5.0V LDO Regulator, 3LD DDPAK
d)	MCP1790-3002E/DB: 3.0V LDO Regulator, 3LD SOT-223
e)	MCP1790-3302E/DB: 3.3V LDO Regulator, 3LD SOT-223
f)	MCP1790-5002E/DB: 5.0V LDO Regulator, 3LD SOT-223
a)	MCP1791-3002E/ET: 3.0V LDO Regulator 5LD DDPAK
b)	MCP1791-3302E/ET 3.3V LDO Regulator 5LD DDPAK
c)	MCP1791-5002E/ET: 5.0V LDO Regulator 5LD DDPAK
d)	MCP1791-3002E/DC 3.0V LDO Regulator 5LD SOT-223
e)	MCP1791-3302E/DC 3.3V LDO Regulator 5LD SOT-223
f)	MCP1791-5002E/DC 5.0V LDO Regulator 5LD SOT-223

# MCP1790/MCP1791

---

NOTES:



---

**Note the following details of the code protection feature on Microchip devices:**

- Microchip products meet the specification contained in their particular Microchip Data Sheet.
- Microchip believes that its family of products is one of the most secure families of its kind on the market today, when used in the intended manner and under normal conditions.
- There are dishonest and possibly illegal methods used to breach the code protection feature. All of these methods, to our knowledge, require using the Microchip products in a manner outside the operating specifications contained in Microchip's Data Sheets. Most likely, the person doing so is engaged in theft of intellectual property.
- Microchip is willing to work with the customer who is concerned about the integrity of their code.
- Neither Microchip nor any other semiconductor manufacturer can guarantee the security of their code. Code protection does not mean that we are guaranteeing the product as “unbreakable.”

Code protection is constantly evolving. We at Microchip are committed to continuously improving the code protection features of our products. Attempts to break Microchip's code protection feature may be a violation of the Digital Millennium Copyright Act. If such acts allow unauthorized access to your software or other copyrighted work, you may have a right to sue for relief under that Act.

---

Information contained in this publication regarding device applications and the like is provided only for your convenience and may be superseded by updates. It is your responsibility to ensure that your application meets with your specifications. MICROCHIP MAKES NO REPRESENTATIONS OR WARRANTIES OF ANY KIND WHETHER EXPRESS OR IMPLIED, WRITTEN OR ORAL, STATUTORY OR OTHERWISE, RELATED TO THE INFORMATION, INCLUDING BUT NOT LIMITED TO ITS CONDITION, QUALITY, PERFORMANCE, MERCHANTABILITY OR FITNESS FOR PURPOSE. Microchip disclaims all liability arising from this information and its use. Use of Microchip devices in life support and/or safety applications is entirely at the buyer's risk, and the buyer agrees to defend, indemnify and hold harmless Microchip from any and all damages, claims, suits, or expenses resulting from such use. No licenses are conveyed, implicitly or otherwise, under any Microchip intellectual property rights.

**Trademarks**

The Microchip name and logo, the Microchip logo, Accuron, dsPIC, KEELOQ, KEELOQ logo, MPLAB, PIC, PICmicro, PICSTART, PRO MATE, rPIC and SmartShunt are registered trademarks of Microchip Technology Incorporated in the U.S.A. and other countries.

FilterLab, Linear Active Thermistor, MXDEV, MXLAB, SEEVAL, SmartSensor and The Embedded Control Solutions Company are registered trademarks of Microchip Technology Incorporated in the U.S.A.

Analog-for-the-Digital Age, Application Maestro, CodeGuard, dsPICDEM, dsPICDEM.net, dsPICworks, dsSPEAK, ECAN, ECONOMONITOR, FanSense, In-Circuit Serial Programming, ICSP, ICEPIC, Mindi, MiWi, MPASM, MPLAB Certified logo, MPLIB, MPLINK, mTouch, PICkit, PICDEM, PICDEM.net, PICtail, PIC<sup>32</sup> logo, PowerCal, PowerInfo, PowerMate, PowerTool, REAL ICE, rLAB, Select Mode, Total Endurance, UNI/O, WiperLock and ZENA are trademarks of Microchip Technology Incorporated in the U.S.A. and other countries.

SQTP is a service mark of Microchip Technology Incorporated in the U.S.A.

All other trademarks mentioned herein are property of their respective companies.

© 2008, Microchip Technology Incorporated, Printed in the U.S.A., All Rights Reserved.

 Printed on recycled paper.

**QUALITY MANAGEMENT SYSTEM  
CERTIFIED BY DNV  
== ISO/TS 16949:2002 ==**

*Microchip received ISO/TS-16949:2002 certification for its worldwide headquarters, design and wafer fabrication facilities in Chandler and Tempe, Arizona; Gresham, Oregon and design centers in California and India. The Company's quality system processes and procedures are for its PIC® MCUs and dsPIC® DSCs, KEELOQ® code hopping devices, Serial EEPROMs, microperipherals, nonvolatile memory and analog products. In addition, Microchip's quality system for the design and manufacture of development systems is ISO 9001:2000 certified.*



---

---

## WORLDWIDE SALES AND SERVICE

---

---

### AMERICAS

**Corporate Office**  
2355 West Chandler Blvd.  
Chandler, AZ 85224-6199  
Tel: 480-792-7200  
Fax: 480-792-7277  
Technical Support:  
<http://support.microchip.com>  
Web Address:  
[www.microchip.com](http://www.microchip.com)

**Atlanta**  
Duluth, GA  
Tel: 678-957-9614  
Fax: 678-957-1455

**Boston**  
Westborough, MA  
Tel: 774-760-0087  
Fax: 774-760-0088

**Chicago**  
Itasca, IL  
Tel: 630-285-0071  
Fax: 630-285-0075

**Dallas**  
Addison, TX  
Tel: 972-818-7423  
Fax: 972-818-2924

**Detroit**  
Farmington Hills, MI  
Tel: 248-538-2250  
Fax: 248-538-2260

**Kokomo**  
Kokomo, IN  
Tel: 765-864-8360  
Fax: 765-864-8387

**Los Angeles**  
Mission Viejo, CA  
Tel: 949-462-9523  
Fax: 949-462-9608

**Santa Clara**  
Santa Clara, CA  
Tel: 408-961-6444  
Fax: 408-961-6445

**Toronto**  
Mississauga, Ontario,  
Canada  
Tel: 905-673-0699  
Fax: 905-673-6509

### ASIA/PACIFIC

**Asia Pacific Office**  
Suites 3707-14, 37th Floor  
Tower 6, The Gateway  
Harbour City, Kowloon  
Hong Kong  
Tel: 852-2401-1200  
Fax: 852-2401-3431

**Australia - Sydney**  
Tel: 61-2-9868-6733  
Fax: 61-2-9868-6755

**China - Beijing**  
Tel: 86-10-8528-2100  
Fax: 86-10-8528-2104

**China - Chengdu**  
Tel: 86-28-8665-5511  
Fax: 86-28-8665-7889

**China - Hong Kong SAR**  
Tel: 852-2401-1200  
Fax: 852-2401-3431

**China - Nanjing**  
Tel: 86-25-8473-2460  
Fax: 86-25-8473-2470

**China - Qingdao**  
Tel: 86-532-8502-7355  
Fax: 86-532-8502-7205

**China - Shanghai**  
Tel: 86-21-5407-5533  
Fax: 86-21-5407-5066

**China - Shenyang**  
Tel: 86-24-2334-2829  
Fax: 86-24-2334-2393

**China - Shenzhen**  
Tel: 86-755-8203-2660  
Fax: 86-755-8203-1760

**China - Wuhan**  
Tel: 86-27-5980-5300  
Fax: 86-27-5980-5118

**China - Xiamen**  
Tel: 86-592-2388138  
Fax: 86-592-2388130

**China - Xian**  
Tel: 86-29-8833-7252  
Fax: 86-29-8833-7256

**China - Zhuhai**  
Tel: 86-756-3210040  
Fax: 86-756-3210049

### ASIA/PACIFIC

**India - Bangalore**  
Tel: 91-80-4182-8400  
Fax: 91-80-4182-8422

**India - New Delhi**  
Tel: 91-11-4160-8631  
Fax: 91-11-4160-8632

**India - Pune**  
Tel: 91-20-2566-1512  
Fax: 91-20-2566-1513

**Japan - Yokohama**  
Tel: 81-45-471- 6166  
Fax: 81-45-471-6122

**Korea - Daegu**  
Tel: 82-53-744-4301  
Fax: 82-53-744-4302

**Korea - Seoul**  
Tel: 82-2-554-7200  
Fax: 82-2-558-5932 or  
82-2-558-5934

**Malaysia - Kuala Lumpur**  
Tel: 60-3-6201-9857  
Fax: 60-3-6201-9859

**Malaysia - Penang**  
Tel: 60-4-227-8870  
Fax: 60-4-227-4068

**Philippines - Manila**  
Tel: 63-2-634-9065  
Fax: 63-2-634-9069

**Singapore**  
Tel: 65-6334-8870  
Fax: 65-6334-8850

**Taiwan - Hsin Chu**  
Tel: 886-3-572-9526  
Fax: 886-3-572-6459

**Taiwan - Kaohsiung**  
Tel: 886-7-536-4818  
Fax: 886-7-536-4803

**Taiwan - Taipei**  
Tel: 886-2-2500-6610  
Fax: 886-2-2508-0102

**Thailand - Bangkok**  
Tel: 66-2-694-1351  
Fax: 66-2-694-1350

### EUROPE

**Austria - Wels**  
Tel: 43-7242-2244-39  
Fax: 43-7242-2244-393

**Denmark - Copenhagen**  
Tel: 45-4450-2828  
Fax: 45-4485-2829

**France - Paris**  
Tel: 33-1-69-53-63-20  
Fax: 33-1-69-30-90-79

**Germany - Munich**  
Tel: 49-89-627-144-0  
Fax: 49-89-627-144-44

**Italy - Milan**  
Tel: 39-0331-742611  
Fax: 39-0331-466781

**Netherlands - Drunen**  
Tel: 31-416-690399  
Fax: 31-416-690340

**Spain - Madrid**  
Tel: 34-91-708-08-90  
Fax: 34-91-708-08-91

**UK - Wokingham**  
Tel: 44-118-921-5869  
Fax: 44-118-921-5820