

Data Sheet



SCA830-D06 1-AXIS HIGH PERFORMANCE ACCELEROMETER WITH DIGITAL SPI INTERFACE

Features

- 3.3V supply voltage
- ± 2 g measurement range
- Single axis measurement in Y direction
- ± 50 mg offset accuracy over temp range
- Internal temperature sensor
- SPI digital interface
- Enhanced self diagnostics features
- Size 7.6 x 3.3 x 8.6 mm (w x h x l)
- Qualified according to the AEC-Q100 standard
- Package, pin-out and SPI protocol compatible with VTI digital accelerometer product family
- RoHS compliant Dual Flat Lead (DFL) plastic package suitable for lead-free soldering process and SMD mounting
- Proven capacitive 3D-MEMS technology

Applications

The SCA830-D06 is targeted to automotive applications. Typical applications include

- Hill Start Aid (HSA)
- Electronic Parking Brake (EPB)
- Roll Over detection
- Suspension control
- Motion and position measurements

General Description

The SCA830-D06 is a single axis inclinometer component based on VTI's capacitive 3D-MEMS technology. The component integrates high accuracy micromechanical acceleration sensing together with a flexible SPI digital interface. Dual Flat Lead (DFL) housing guarantees reliable operation over product lifetime.

The SCA830-D06 is designed, manufactured and tested for high stability, reliability and quality requirements of automotive applications. The inclinometer has an extremely stable output over wide ranges of temperature, humidity and mechanical noise. The component is qualified to the AEC-Q100 standard and has several advanced self diagnostics features. The DFL housing is suitable for SMD mounting and the component is compatible with the RoHS and ELV directives.

The SCA830-D06 is a part of VTI's digital accelerometer family and fully compatible with its multi axis accelerometers (SCA2100 series and SCA3100 series) and other single axis accelerometers (SCA800 series).

Performance Characteristics

V_{dd}=3.3 V and ambient temperature unless otherwise specified.

Parameter	Condition				Units
		Min	Typ ^{A)}	Max	
Analog and digital V _{dd}		3.0		3.6	V
Current consumption	Active mode		5	6.3	mA
	Power down mode			0.1	mA
Measurement range	Measurement axes (Y)	-2		2	g
Operating temperature		-40		125	°C
Offset total error ^{B)}	Temperature range -40 ... +125 °C	-70		70	mg
Offset calibration error ^{C)}	@25 °C ±5°C	-40	±25	40	mg
Offset temperature drift	Temperature range -40 ... +125 °C	-30 ^{D)}	±22 ^{E)}	30 ^{D)}	mg
	Temperature range -20 ... +85 °C		±13		mg
Sensitivity	12 bit output		900		Count/g
	Between ±3°		0.0637		%/Count
Total sensitivity error	Temperature range -40 ... +125 °C	-4		4	% FS
Sensitivity calibration error	@25 °C ±5°C		±1		% FS
Sensitivity temperature drift	Temperature range -40 ... +125 °C		±1		% FS
Linearity error	+1g ... -1g range, end point fit	-20		20	mg
	+2g ... -2g range, end point fit	-40		40	mg
Cross-Axis sensitivity				±3.5	%
Zero acceleration output	2-complement		0		Counts
Amplitude response	-3dB frequency	30		80	Hz
Noise				5	mg RMS
Power on setup time				0.1	s
Output data rate			2000		Hz
Output load				50	pF
SPI clock rate				8	MHz
ESD	Human Body Model			2	kV
	Charge Device Model			1	kV
Solderability	IPC/JEDEC J-STD-020C, +245 °C, 40 s				
Moisture level	IPC/JEDEC J-STD-020C, Level 3				
Mechanical shock				20 000	g
ID register value	Customer readable ID register (27hex)		05		

- A) Typical ± values are ±3 sigma variation limits from validation test population.
 B) Includes offset deviation from 0g value including calibration error and drift over lifetime, temperature and supply voltage.
 C) Includes offset deviation from 0g value including calibration error and drift over lifetime.
 D) Offset drift due to temperature. Value is a relative value and has not been centered to 0g. Error defined as maximum change of offset in temperature range. Offset (max)-Offset (Min). 100% tested in production.
 E) Biggest change of output from RT value due temperature.

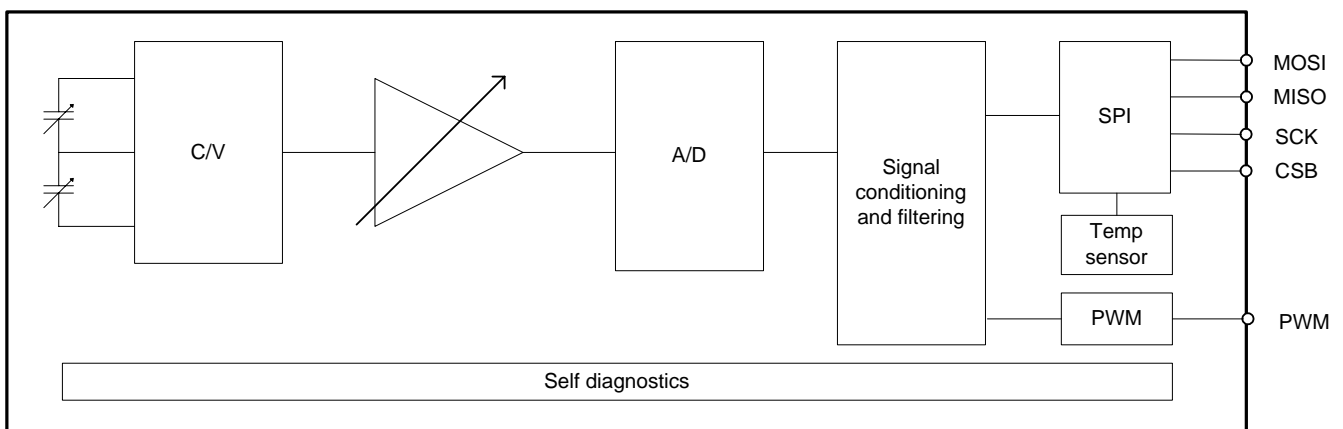
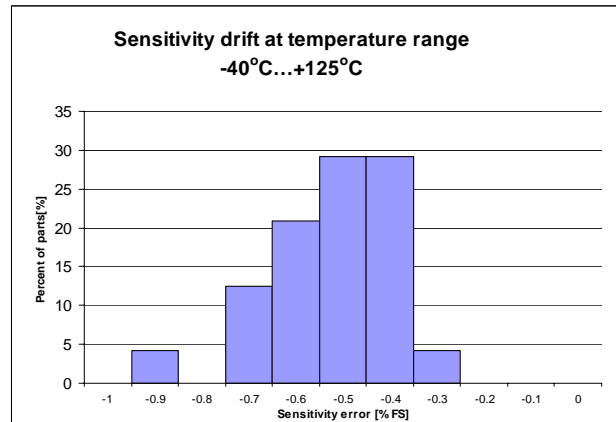
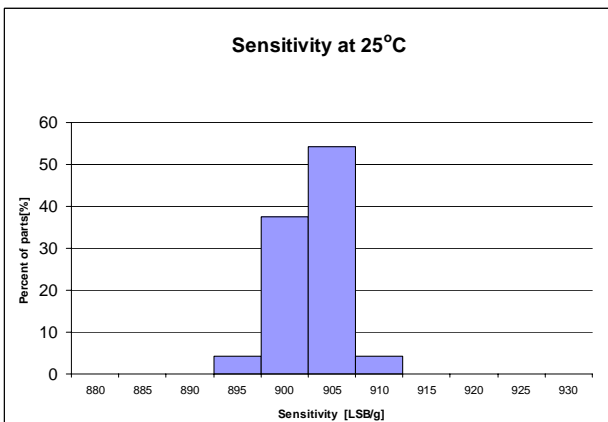
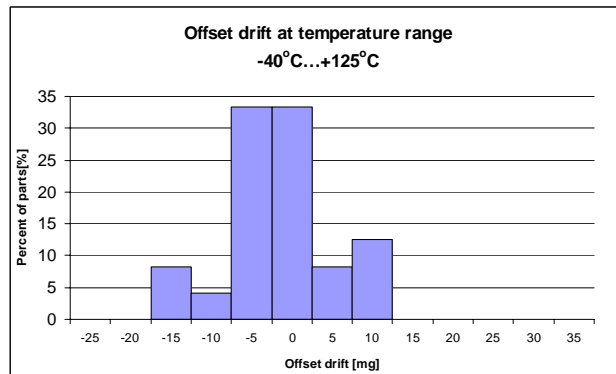
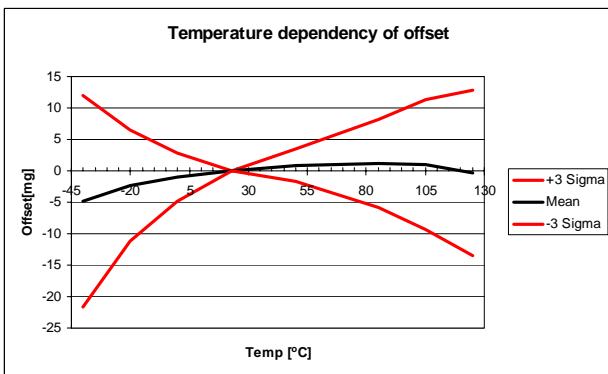
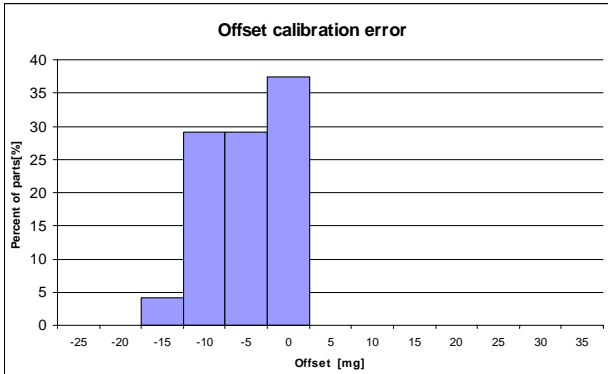

Figure 1. SCA810-D02 Block diagram

Typical Performance characteristics



Measurement directions

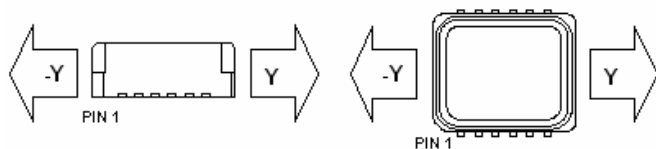

Figure 1. Accelerometer measuring directions

Housing dimensions

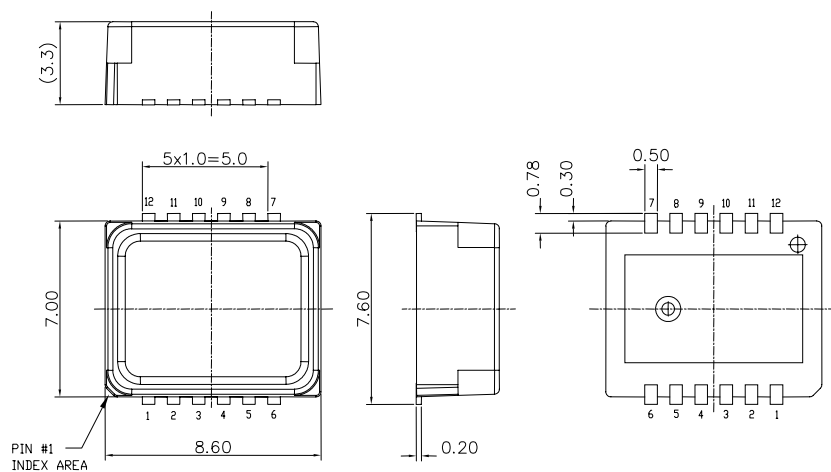

Figure 2. Housing dimensions

Contact Information

<p>Finland (head office) VTI Technologies Oy P.O. Box 27 Myllynkivenkuja 6 FI-01621 Vantaa Finland Tel. +358 9 879 181 Fax +358 9 8791 8791 E-mail: sales@vti.fi</p>	<p>Germany VTI Technologies Oy Branch Office Frankfurt Rennbahnstrasse 72-74 D-60528 Frankfurt am Main, Germany Tel. +49 69 6786 880 Fax +49 69 6786 8829 E-mail: sales.de@vti.fi</p>	<p>USA VTI Technologies, Inc. One Parklane Blvd. Suite 804 - East Tower Dearborn, MI 48126 USA Tel. +1 313 425 0850 Fax +1 313 425 0860 E-mail sales@vtitechnologies.com</p>
<p>Japan Akebono Brake Industry Co.,Ltd. 5-4-71 Higashi, Hanyu-city Saitama Pref., 348-8501 Japan Tel. +81 48 560 1470 Fax +81 48 560 1469 www.akebono-brake.co.jp E-mail: forename.surname@vti.fi</p>	<p>China VTI Technologies Shanghai Office 6th floor, Room 618 780 Cailun Lu Pudong New Area 201203 Shanghai P.R. China Tel. +86 21 5132 0418 or +86 21 5132 0400 *112 Fax +86 21 513 20 416 E-mail: forename.surname@vti.fi</p>	<p>To find out your local sales representative visit www.vti.fi</p>