

## +3V to +5V RS-232 Line Driver/Receiver

- Operates from 3.3V or 5V Power Supply
- Meets All EIA-232D and V.28 Specifications at 5V
- Meets EIA-562 Specifications at 3.3V
- Two Drivers and Receivers
- Operates with 0.1 $\mu$ F to 10 $\mu$ F Capacitors
- High Data Rate — 120kbps Under Load
- Low Power Shutdown  $\leq 1\mu$ A
- 3-State TTL/CMOS Receiver Outputs
- Low Power CMOS — 5mA Operation  
Now Available in Lead Free



### DESCRIPTION...

The **Sipex SP385A** is an enhanced version of the **Sipex SP200** family of RS232 line drivers/receivers. The **SP385A** offers +3.3V operation for EIA-562 and EIA-232 applications. The **SP385A** maintains the same performance features offered in its predecessors. The **SP385A** is available in plastic SOIC or SSOP packages operating over the commercial and industrial temperature ranges. The **SP385A** is pin compatible to the LTC1385 EIA-562 transceiver, except the drivers in the **SP385A** can only be disabled with the ON/OFF pin.

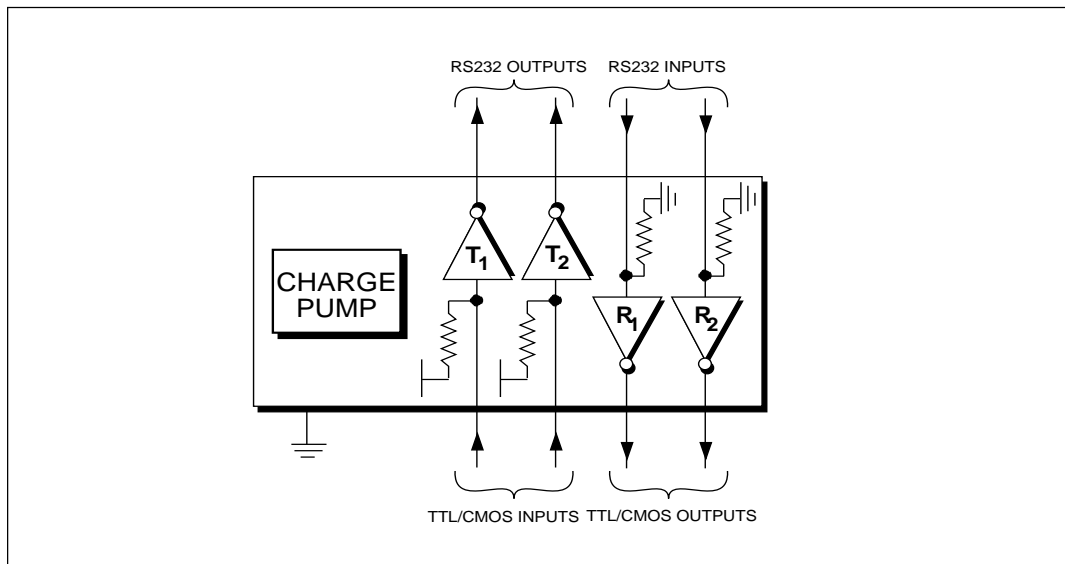

## ABSOLUTE MAXIMUM RATINGS

This is a stress rating only and functional operation of the device at these or any other conditions above those indicated in the operation sections of this specification is not implied. Exposure to absolute maximum rating conditions for extended periods of time may affect reliability.

$V_{CC}$	.....	+6V
$V^+$	.....	( $V_{CC}-0.3V$ ) to +13.2V
$V^-$	.....	13.2V
Input Voltages		
$T_{IN}$	.....	-0.3 to ( $V_{CC}+0.3V$ )
$R_{IN}$	.....	$\pm 15V$

## Output Voltages

$T_{OUT}$	.....	( $V^+$ , +0.3V) to ( $V^-$ , -0.3V)
$R_{OUT}$	.....	-0.3V to ( $V_{CC}+0.3V$ )
Short Circuit Duration		
$T_{OUT}$	.....	Continuous
Power Dissipation		
CERDIP	.....	675mW (derate 9.5mW/°C above +70°C)
Plastic DIP	.....	375mW (derate 7mW/°C above +70°C)
Small Outline	.....	375mW (derate 7mW/°C above +70°C)

## SPECIFICATIONS

$V_{CC}=+3.3V\pm 10\%$ ; 0.1 $\mu$ F charge pump capacitors;  $T_{MIN}$  to  $T_{MAX}$  unless otherwise noted.

PARAMETERS	MIN.	TYP.	MAX.	UNITS	CONDITIONS
<b>TTL INPUT</b>					
Logic Threshold			0.8	Volts	$T_{IN}$ ; ON/OFF $V_{CC} = 3.3V$ $T_{IN}$ ; ON/OFF $V_{CC} = 3.3V$ $T_{IN} = 0V$ $C_L = 2500pF$ , $R_L = 3k\Omega$
Low	2.0			Volts	
High		15	200	$\mu$ A	
Logic Pullup Current				kbps	
Maximum Data Rate	120				
<b>TTL OUTPUT</b>					
TTL/CMOS Output			0.5	Volts	$I_{OUT} = 3.2mA$ ; $V_{CC} = 3.3V$ $I_{OUT} = -1.0mA$ ON/OFF=0V, $0V \leq V_{OUT} \leq V_{CC}$
Voltage, Low	2.4			Volts	
Voltage, High		0.05	$\pm 10$	$\mu$ A	
Leakage Current; $T_A = +25^\circ C$					
<b>EIA-562 OUTPUT</b>					
Output Voltage Swing	$\pm 3.7$	$\pm 4.2$		Volts	All transmitter outputs loaded with 3k $\Omega$ to ground $V_{CC} = 0V$ ; $V_{OUT} = \pm 2V$ Infinite duration
Power-Off Output Resistance	300			$\Omega$	
Output Short Circuit Current		$\pm 10$		mA	
<b>EIA-562 INPUT</b>					
Voltage Range	-15		+15	Volts	$V_{CC} = 3.3V$ , $T_A = +25^\circ C$ $V_{CC} = 3.3V$ , $T_A = +25^\circ C$ $V_{CC} = 3.3V$ , $T_A = +25^\circ C$ $V_{IN} = 15V$ to -15V
Voltage Threshold					
Low	0.8	1.2		Volts	
High		1.7	2.4	Volts	
Hysteresis	0.2	0.5	1.0	Volts	
Resistance	3	5	7	k $\Omega$	
<b>DYNAMIC CHARACTERISTICS</b>					
Driver Propagation Delay		4.0		$\mu$ s	TTL to RS-562 RS-562 to TTL $C_L = 10pF$ , $R_L = 3k\Omega - 7k\Omega$ ; $T_A = +25^\circ C$ $C_L = 2500pF$ , $R_L = 3k\Omega$ ; measured from +2V to -2V or -2V to +2V
Receiver Propagation Delay		1.5		$\mu$ s	
Instantaneous Slew Rate			30	V/ $\mu$ s	
Transition Region Slew Rate		10		V/ $\mu$ s	
Output Enable Time		300		ns	
Output Disable Time		1000		ns	
<b>POWER REQUIREMENTS</b>					
$V_{CC}$ Power Supply Current		3 8	6	mA mA	No load, $T_A = +25^\circ C$ ; $V_{CC} = 3.3V$ All transmitters $R_L = 3k\Omega$ $T_A = +25^\circ C$ $V_{CC} = 3.3V$ , $T_A = +25^\circ C$
Shutdown Supply Current		0.010	5	$\mu$ A	

# SPECIFICATIONS

$V_{CC} = +5V \pm 10\%$ ; 0.1  $\mu F$  charge pump capacitors;  $T_{MIN}$  to  $T_{MAX}$  unless otherwise noted.

PARAMETERS	MIN.	TYP.	MAX.	UNITS	CONDITIONS
<b>TTL INPUT</b>					
Logic Threshold					
Low			0.8	Volts	$T_{IN}$ ; ON/OFF
High	2.0			Volts	$T_{IN}$ ; ON/OFF
Logic Pullup Current		15	200	$\mu A$	$T_{IN} = 0V$
Maximum Data Rate	120			kbps	$C_L = 2500pF, R_L = 3k\Omega$
<b>TTL OUTPUT</b>					
TTL/CMOS Output					
Voltage, Low			0.4	Volts	$I_{OUT} = 3.2mA; V_{CC} = +5V$
Voltage, High	3.5			Volts	$I_{OUT} = -1.0mA$
Leakage Current; $T_A = +25^\circ C$		0.05	$\pm 10$	$\mu A$	ON/OFF = $\emptyset, 0V \leq V_{OUT} \leq V_{CC}$
<b>EIA-232 OUTPUT</b>					
Output Voltage Swing	$\pm 5$	$\pm 9$		Volts	All transmitter outputs loaded with $3k\Omega$ to ground
Power-Off Output Resistance	300			$\Omega$	$V_{CC} = 0V; V_{OUT} = \pm 2V$
Output Short Circuit Current		$\pm 18$		mA	Infinite duration
<b>EIA-232 INPUT</b>					
Voltage Range	-15		+15	Volts	
Voltage Threshold					
Low	0.8	1.2		Volts	$V_{CC} = 5V, T_A = +25^\circ C$
High		1.7	2.4	Volts	$V_{CC} = 5V, T_A = +25^\circ C$
Hysteresis	0.2	0.5	1.0	Volts	$V_{CC} = 5V, T_A = +25^\circ C$
Resistance	3	5	7	$k\Omega$	$V_{IN} = 15V$ to $-15V$
<b>DYNAMIC CHARACTERISTICS</b>					
Driver Propagation Delay		4.0		$\mu s$	TTL to RS-232
Receiver Propagation Delay		1.5		$\mu s$	RS-232 to TTL
Instantaneous Slew Rate			30	V/ $\mu s$	$C_L = 10pF, R_L = 3k\Omega - 7k\Omega;$ $T_A = +25^\circ C$
Transition Region Slew Rate		10		V/ $\mu s$	$C_L = 2500pF, R_L = 3k\Omega;$ measured from +3V to -3V or -3V to +3V
Output Enable Time		400		ns	
Output Disable Time		250		ns	
<b>POWER REQUIREMENTS</b>					
$V_{CC}$ Power Supply Current		10 25	15	mA mA	No load, $T_A = +25^\circ C; V_{CC} = 5V$ All transmitters $R_L = 3k\Omega;$ $T_A = +25^\circ C$
Shutdown Supply Current		1	10	$\mu A$	$V_{CC} = 5V, T_A = +25^\circ C$

## PERFORMANCE CURVES

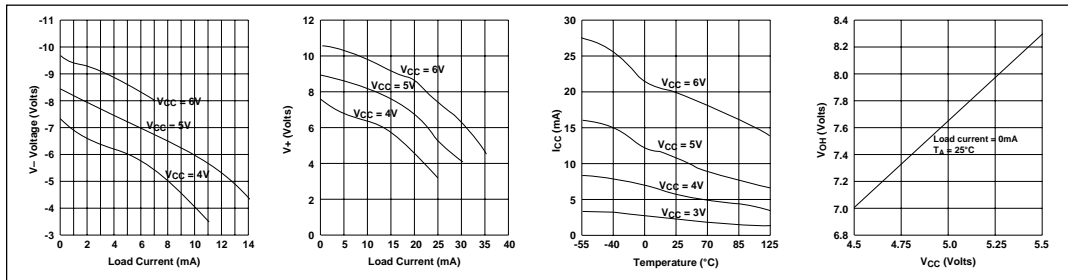



## FEATURES...

The **Sipex SP385A** is a +3V to +5V EIA-232/EIA-562 line transceiver. It is a pin-for-pin alternative for the SP310A and will operate in the same socket with capacitors ranging from 0.1 $\mu$ F to 10 $\mu$ F, either polarized or non-polarized, in +3V supplies. The **SP385A** offers the same features such as 120kbps guaranteed transmission rate, increased drive current for longer and more flexible cable configurations, low power dissipation and overall ruggedized construction for commercial and industrial environments. The **SP385A** also includes a shutdown feature that tri-states the drivers and the receivers.

The **SP385A** includes a charge pump voltage converter which allows it to operate from a single +3.3V or +5V supply. These converters double the  $V_{CC}$  voltage input in order to generate the EIA-232 or EIA-562 output levels. For +5V operation, the **SP385A** driver outputs adhere to all EIA-232D and CCITT V.28 specifications. While at +3.3V operation, the outputs adhere to EIA-562 specifications. Due to **Sipex's** efficient charge pump design, the charge pump levels and the driver outputs are less noisy than other 3V EIA-232 transceivers.

The **SP385A** has a single control line which simultaneously shuts down the internal DC/DC converter and puts all transmitter and receiver outputs into a high impedance state.

The **SP385A** is available in 18-pin plastic SOIC and 20-pin plastic SSOP packages for operation over commercial and industrial temperature ranges. Please consult the factory for surface-mount packaged parts supplied on tape-on-reel as well as parts screened to MIL-M-38510.

The **SP385A** is ideal for +3.3V battery applications requiring low power operation. The charge pump strength allows the drivers to provide  $\pm 4.0V$  signals, plenty for typical EIA-232 applications since the EIA-232 receivers have input sensitivity levels of less than  $\pm 3V$ .

## THEORY OF OPERATION

The **SP385A** device is made up of three basic circuit blocks — 1) a driver/transmitter, 2) a receiver and 3) a charge pump.

## Driver/Transmitter

The drivers are inverting transmitters, which accept TTL or CMOS inputs and output the RS-232 signals with an inverted sense relative to the input logic levels. Typically the RS-232 output voltage swing is  $\pm 9V$  for 5V supply and  $\pm 4.2V$  for 3.3V supply. Even under worst case loading conditions of 3k $\Omega$  and 2500pF, the output is guaranteed to be  $\pm 5V$  for a 5V supply and  $\pm 3.7V$  for a 3.3V supply which adheres to EIA-232 and EIA-562 specifications, respectively. The transmitter outputs are protected against infinite short-circuits to ground without degradation in reliability.

The instantaneous slew rate of the transmitter output is internally limited to a maximum of 30V/ $\mu$ s in order to meet the standards [EIA 232-D 2.1.7, Paragraph (5)]. However, the transition region slew rate of these enhanced products is typically 10V/ $\mu$ s. The smooth transition of the loaded output from  $V_{OL}$  to  $V_{OH}$  clearly meets the monotonicity requirements of the standard [EIA 232-D 2.1.7, Paragraphs (1) & (2)].

## Receivers

The receivers convert RS-232 input signals to inverted TTL signals. Since the input is usually from a transmission line, where long cable lengths and system interference can degrade the signal, the inputs have a typical hysteresis margin of 500mV. This ensures that the receiver is virtually immune to noisy transmission lines.

The input thresholds are 0.8V minimum and 2.4V maximum, again well within the  $\pm 3V$  RS-232 requirements. The receiver inputs are also protected against voltages up to  $\pm 15V$ . Should an input be left unconnected, a 5k $\Omega$  pull-down resistor to ground will commit the output of the receiver to a high state.

In actual system applications, it is quite possible for signals to be applied to the receiver inputs before power is applied to the receiver circuitry. This occurs for example when a PC user attempts to print only to realize the printer wasn't turned on. In this case an RS-232 signal from the PC will appear on the receiver input at the printer. When the printer power is turned on, the receiver will operate normally. All of these enhanced devices are fully protected.

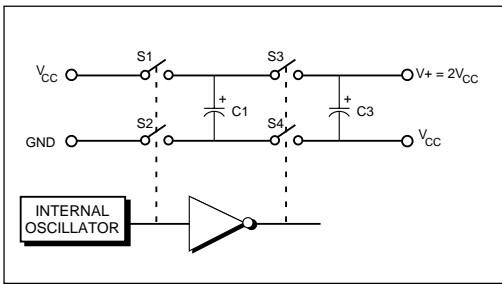

Figure 1. Charge Pump Voltage Doubler

## Charge Pump

The charge pump section of these devices allows the circuit to operate from a single +5V  $\pm 10\%$  power supply by generating the required operating voltages internal to the devices. The charge pump consists of two sections — 1) a voltage doubler and 2) a voltage inverter.

As shown in *Figure 1*, an internal oscillator triggers the charge accumulation and voltage inversion. The voltage doubler momentarily stores a charge on capacitor  $C_1$  equal to  $V_{cc}$ , referenced to ground. During the next transition of the oscillator this charge is boot-strapped to transfer charge to capacitor  $C_3$ . The voltage across  $C_3$  is now from  $V_{cc}$  to  $V^+$ .

In the inverter section (*Figure 2*), the voltage across  $C_3$  is transferred to  $C_2$  forcing a range of 0V to  $V^+$  across  $C_2$ . Boot-strapping of  $C_2$  will then transfer charge to  $C_4$  to generate  $V^-$ .

One of the significant enhancements over previous products of this type is that the values of the capacitors are no longer critical and have been decreased in size considerably to 0.1 $\mu$ F. Because the charge pump runs at a higher frequency, the 0.1 $\mu$ F capacitors are sufficient to transfer and sustain charges to the two transmitters.

## APPLICATION HINTS

### Protection From Shorts to $\pm 15V$

The driver outputs are protected against shorts to ground, other driver outputs, and  $V^+$  or  $V^-$ . If the possibility exists that the outputs could be inadvertently connected to voltages higher than  $\pm 15V$ , then it is recommended that external protection be provided. For protection against

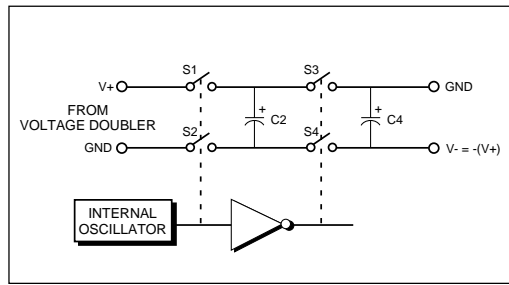

Figure 2. Charge Pump Voltage Inverter

voltages exceeding  $\pm 15V$ , two back-to-back zener diodes connected from each output to ground will clamp the outputs to an acceptable voltage level.

## Shutdown ( $ON/\overline{OFF}$ )

The **SP385A** has a shut-down/standby mode to conserve power in battery-powered systems. To activate the shutdown mode, which stops the operation of the charge pump, a logic "0" is applied to the appropriate control line. The shutdown mode is controlled on the **SP385A** by a logic "0" on the  $ON/\overline{OFF}$  control line (pin 18 for the SOIC and pin 20 for the SSOP packages); this puts the transmitter outputs in a tri-state mode.

**PACKAGE: PLASTIC  
SMALL OUTLINE (SOIC)  
(WIDE)**

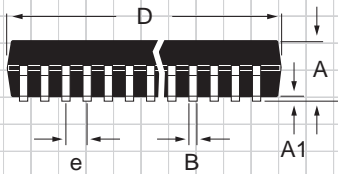
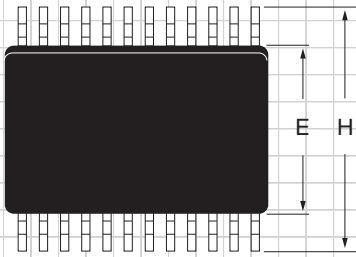

DIMENSIONS (Inches) Minimum/Maximum (mm)	18-PIN
A	0.093/0.104 (2.352/2.649)
A1	0.004/0.012 (0.102/0.300)
B	0.013/0.020 (0.330/0.508)
D	0.447/0.463 (11.35/11.74)
E	0.291/0.299 (7.402/7.600)
e	0.050 BSC (1.270 BSC)
H	0.394/0.419 (10.00/10.64)
L	0.016/0.050 (0.406/1.270)
Ø	0°/8° (0°/8°)

**PACKAGE: PLASTIC SHRINK  
SMALL OUTLINE  
(SSOP)**

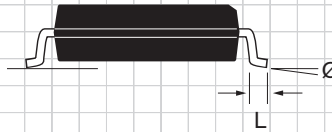
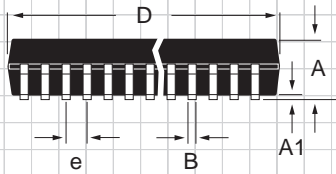
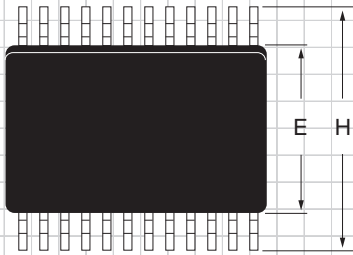

DIMENSIONS (Inches) Minimum/Maximum (mm)	20-PIN
A	0.068/0.078 (1.73/1.99)
A1	0.002/0.008 (0.05/0.21)
B	0.010/0.015 (0.25/0.38)
D	0.278/0.289 (7.07/7.33)
E	0.205/0.212 (5.20/5.38)
e	0.026 BSC (0.65 BSC)
H	0.301/0.311 (7.65/7.90)
L	0.022/0.037 (0.55/0.95)
Ø	0°/8° (0°/8°)



## ORDERING INFORMATION

Model .....	Temperature Range .....	Package
SP385ACA .....	0°C to +70°C .....	20-pin SSOP
SP385AEA .....	-40°C to +85°C .....	20-pin SSOP
SP385ACT .....	0°C to +70°C .....	18-pin SOIC
SP385AET .....	-40°C to +85°C .....	18-pin SOIC

CT and ET packages available Tape-on-Reel. Please consult the factory for pricing and availability for this option, and for parts screened to MIL-STD-883.

Available in Lead free packaging.  
To order add "-L" suffix to the part  
number. EXAMPLE: SP385EET/ER = standard,  
SP385EET/ER-L = lead free.



SIGNAL PROCESSING EXCELLENCE

### Sipex Corporation

#### Headquarters and

#### Sales Office

22 Linnell Circle  
Billerica, MA 01821  
TEL: (978) 667-8700  
FAX: (978) 670-9001  
e-mail: sales@sipex.com

#### Sales Office

233 South Hillview Drive  
Milpitas, CA 95035  
TEL: (408) 934-7500  
FAX: (408) 935-7600

### Far East:

#### JAPAN:

Nippon Sipex Corporation  
Yahagi No. 2 Building  
3-5-3 Uchikanda, Chiyoda-ku  
Tokyo 101  
TEL: 81.3.3256.0577  
FAX: 81.3.3256.0621

Sipex Corporation reserves the right to make changes to any products described herein. Sipex does not assume any liability arising out of the application or use of any product or circuit described hereing; neither does it convey any license under its patent rights nor the rights of others.