

Features

- Low-voltage and Standard-voltage Operation
 - 2.7 ($V_{CC} = 2.7V$ to 5.5V)
 - 1.8 ($V_{CC} = 1.8V$ to 5.5V)
- Internally Organized 128 x 8 (1K), 256 x 8 (2K), 512 x 8 (4K), 1024 x 8 (8K) or 2048 x 8 (16K)
- 2-wire Serial Interface
- Schmitt Trigger, Filtered Inputs for Noise Suppression
- Bi-directional Data Transfer Protocol
- 100 kHz (1.8V, 2.5V, 2.7V) and 400 kHz (5V) Compatibility
- Write Protect Pin for Hardware Data Protection
- 8-byte Page (1K, 2K), 16-byte Page (4K, 8K, 16K) Write Modes
- Partial Page Writes are Allowed
- Self-timed Write Cycle (10 ms max)
- High-reliability
 - Endurance: 1 Million Write Cycles
 - Data Retention: 100 Years
- Automotive Grade, Extended Temperature and Lead-Free Devices Available
- 8-lead PDIP, 8-lead JEDEC SOIC, 8-lead MAP and 8-lead TSSOP Packages

Description

The AT24C01A/02/04/08/16 provides 1024/2048/4096/8192/16384 bits of serial electrically erasable and programmable read-only memory (EEPROM) organized as 128/256/512/1024/2048 words of 8 bits each. The device is optimized for use in many industrial and commercial applications where low-power and low-voltage operation are essential. The AT24C01A/02/04/08/16 is available in space-saving 8-lead PDIP, 8-lead JEDEC SOIC, 8-lead MAP and 8-lead TSSOP packages and is accessed via a 2-wire serial interface. In addition, the entire family is available in 2.7V (2.7V to 5.5V) and 1.8V (1.8V to 5.5V) versions.

Pin Configurations

Pin Name	Function
A0 - A2	Address Inputs
SDA	Serial Data
SCL	Serial Clock Input
WP	Write Protect
NC	No Connect

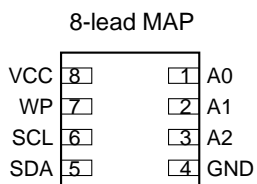
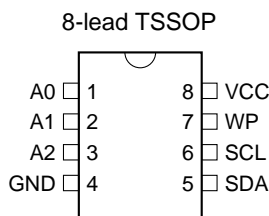

Bottom View

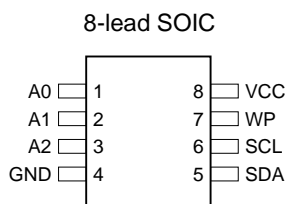
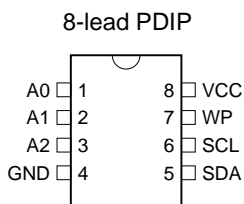

2-wire Serial EEPROM

1K (128 x 8)

2K (256 x 8)

4K (512 x 8)

8K (1024 x 8)

16K (2048 x 8)

AT24C01A

AT24C02

AT24C04

AT24C08

AT24C16



Absolute Maximum Ratings

Operating Temperature	-55°C to +125°C
Storage Temperature	-65°C to +150°C
Voltage on Any Pin with Respect to Ground	-1.0V to +7.0V
Maximum Operating Voltage	6.25V
DC Output Current.....	5.0 mA

***NOTICE:** Stresses beyond those listed under “Absolute Maximum Ratings” may cause permanent damage to the device. This is a stress rating only and functional operation of the device at these or any other conditions beyond those indicated in the operational sections of this specification is not implied. Exposure to absolute maximum rating conditions for extended periods may affect device reliability.

Block Diagram

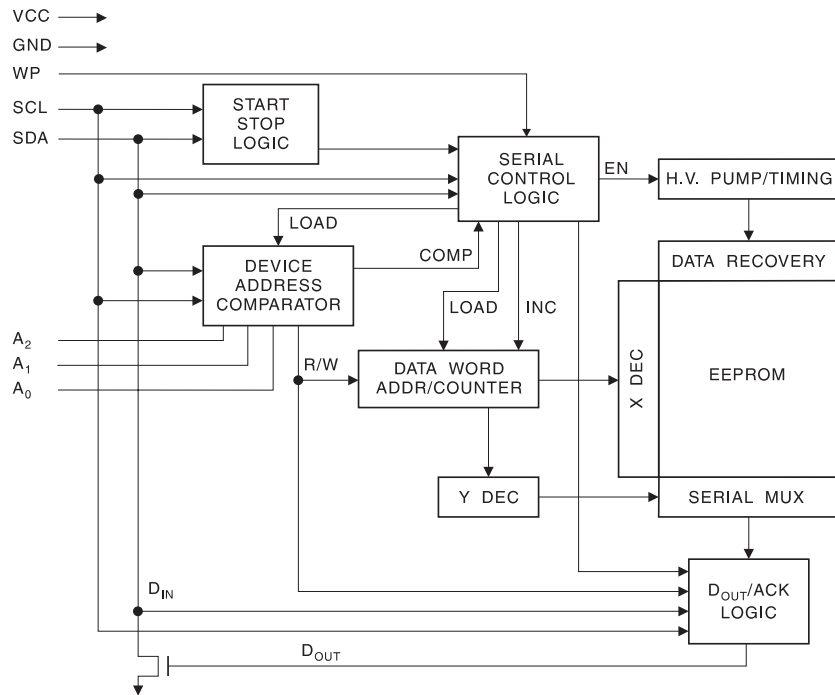

Pin Description

SERIAL CLOCK (SCL): The SCL input is used to positive edge clock data into each EEPROM device and negative edge clock data out of each device.

SERIAL DATA (SDA): The SDA pin is bi-directional for serial data transfer. This pin is open-drain driven and may be wire-ORed with any number of other open-drain or open-collector devices.

DEVICE/PAGE ADDRESSES (A2, A1, A0): The A2, A1 and A0 pins are device address inputs that are hard wired for the AT24C01A and the AT24C02. As many as eight 1K/2K devices may be addressed on a single bus system (device addressing is discussed in detail under the Device Addressing section).

The AT24C04 uses the A2 and A1 inputs for hard wire addressing and a total of four 4K devices may be addressed on a single bus system. The A0 pin is a no connect.

The AT24C08 only uses the A2 input for hardwire addressing and a total of two 8K devices may be addressed on a single bus system. The A0 and A1 pins are no connects.

The AT24C16 does not use the device address pins, which limits the number of devices on a single bus to one. The A0, A1 and A2 pins are no connects.

WRITE PROTECT (WP): The AT24C01A/02/04/16 has a Write Protect pin that provides hardware data protection. The Write Protect pin allows normal read/write operations when connected to ground (GND). When the Write Protect pin is connected to V_{CC} , the write protection feature is enabled and operates as shown in the following table.

WP Pin Status	Part of the Array Protected				
	24C01A	24C02	24C04	24C08	24C16
At V_{CC}	Full (1K) Array	Full (2K) Array	Full (4K) Array	Normal Read/Write Operation	Upper Half (8K) Array
At GND	Normal Read/Write Operations				

Memory Organization AT24C01A, 1K SERIAL EEPROM: Internally organized with 16 pages of 8 bytes each, the 1K requires a 7-bit data word address for random word addressing.

AT24C02, 2K SERIAL EEPROM: Internally organized with 32 pages of 8 bytes each, the 2K requires an 8-bit data word address for random word addressing.

AT24C04, 4K SERIAL EEPROM: Internally organized with 32 pages of 16 bytes each, the 4K requires a 9-bit data word address for random word addressing.

AT24C08, 8K SERIAL EEPROM: Internally organized with 64 pages of 16 bytes each, the 8K requires a 10-bit data word address for random word addressing.

AT24C16, 16K SERIAL EEPROM: Internally organized with 128 pages of 16 bytes each, the 16K requires an 11-bit data word address for random word addressing.

Pin Capacitance⁽¹⁾

Applicable over recommended operating range from $T_A = 25^\circ\text{C}$, $f = 1.0\text{ MHz}$, $V_{CC} = +1.8\text{V}$.

Symbol	Test Condition	Max	Units	Conditions
$C_{I/O}$	Input/Output Capacitance (SDA)	8	pF	$V_{I/O} = 0\text{V}$
C_{IN}	Input Capacitance ($A_0, A_1, A_2, \text{SCL}$)	6	pF	$V_{IN} = 0\text{V}$

Note: 1. This parameter is characterized and is not 100% tested.

DC Characteristics

Applicable over recommended operating range from: $T_{AI} = -40^\circ\text{C}$ to $+85^\circ\text{C}$, $V_{CC} = +1.8\text{V}$ to $+5.5\text{V}$, $T_{AE} = -40^\circ\text{C}$ to $+125^\circ\text{C}$, $V_{CC} = +1.8\text{V}$ to $+5.5\text{V}$ (unless otherwise noted).

Symbol	Parameter	Test Condition	Min	Typ	Max	Units
V_{CC1}	Supply Voltage		1.8		5.5	V
V_{CC2}	Supply Voltage		2.5		5.5	V
V_{CC3}	Supply Voltage		2.7		5.5	V
V_{CC4}	Supply Voltage		4.5		5.5	V
I_{CC}	Supply Current $V_{CC} = 5.0\text{V}$	READ at 100 kHz		0.4	1.0	mA
I_{CC}	Supply Current $V_{CC} = 5.0\text{V}$	WRITE at 100 kHz		2.0	3.0	mA
I_{SB1}	Standby Current $V_{CC} = 1.8\text{V}$	$V_{IN} = V_{CC}$ or V_{SS}		0.6	3.0	μA
I_{SB2}	Standby Current $V_{CC} = 2.5\text{V}$	$V_{IN} = V_{CC}$ or V_{SS}		1.4	4.0	μA
I_{SB3}	Standby Current $V_{CC} = 2.7\text{V}$	$V_{IN} = V_{CC}$ or V_{SS}		1.6	4.0	μA
I_{SB4}	Standby Current $V_{CC} = 5.0\text{V}$	$V_{IN} = V_{CC}$ or V_{SS}		8.0	18.0	μA
I_{LI}	Input Leakage Current	$V_{IN} = V_{CC}$ or V_{SS}		0.10	3.0	μA
I_{LO}	Output Leakage Current	$V_{OUT} = V_{CC}$ or V_{SS}		0.05	3.0	μA
V_{IL}	Input Low Level ⁽¹⁾		-0.6		$V_{CC} \times 0.3$	V
V_{IH}	Input High Level ⁽¹⁾		$V_{CC} \times 0.7$		$V_{CC} + 0.5$	V
V_{OL2}	Output Low Level $V_{CC} = 3.0\text{V}$	$I_{OL} = 2.1\text{ mA}$			0.4	V
V_{OL1}	Output Low Level $V_{CC} = 1.8\text{V}$	$I_{OL} = 0.15\text{ mA}$			0.2	V

Note: 1. V_{IL} min and V_{IH} max are reference only and are not tested.

AC Characteristics

Applicable over recommended operating range from $T_{AI} = -40^{\circ}\text{C}$ to $+85^{\circ}\text{C}$, $T_{AE} = -40^{\circ}\text{C}$ to $+125^{\circ}\text{C}$, $V_{CC} = +1.8\text{V}$ to $+5.5\text{V}$, $CL = 1$ TTL Gate and 100 pF (unless otherwise noted).

Symbol	Parameter	2.7-, 2.5-, 1.8-volt		5.0-volt		Units
		Min	Max	Min	Max	
f_{SCL}	Clock Frequency, SCL		100		400	kHz
t_{LOW}	Clock Pulse Width Low	4.7		1.2		μs
t_{HIGH}	Clock Pulse Width High	4.0		0.6		μs
t_I	Noise Suppression Time ⁽¹⁾		100		50	ns
t_{AA}	Clock Low to Data Out Valid	0.1	4.5	0.1	0.9	μs
t_{BUF}	Time the bus must be free before a new transmission can start ⁽¹⁾	4.7		1.2		μs
$t_{HD,STA}$	Start Hold Time	4.0		0.6		μs
$t_{SU,STA}$	Start Setup Time	4.7		0.6		μs
$t_{HD,DAT}$	Data In Hold Time	0		0		μs
$t_{SU,DAT}$	Data In Setup Time	200		100		ns
t_R	Inputs Rise Time ⁽¹⁾		1.0		0.3	μs
t_F	Inputs Fall Time ⁽¹⁾		300		300	ns
$t_{SU,STO}$	Stop Setup Time	4.7		0.6		μs
t_{DH}	Data Out Hold Time	100		50		ns
t_{WR}	Write Cycle Time		10		10	ms
Endurance ⁽¹⁾	5.0V, 25°C, Byte Mode	1M		1M		Write Cycles

Note: 1. This parameter is characterized and is not 100% tested.

Device Operation

CLOCK and DATA TRANSITIONS: The SDA pin is normally pulled high with an external device. Data on the SDA pin may change only during SCL low time periods (refer to Data Validity timing diagram). Data changes during SCL high periods will indicate a start or stop condition as defined below.

START CONDITION: A high-to-low transition of SDA with SCL high is a start condition which must precede any other command (refer to Start and Stop Definition timing diagram).

STOP CONDITION: A low-to-high transition of SDA with SCL high is a stop condition. After a read sequence, the stop command will place the EEPROM in a standby power mode (refer to Start and Stop Definition timing diagram).

ACKNOWLEDGE: All addresses and data words are serially transmitted to and from the EEPROM in 8-bit words. The EEPROM sends a zero to acknowledge that it has received each word. This happens during the ninth clock cycle.

STANDBY MODE: The AT24C01A/02/04/08/16 features a low-power standby mode which is enabled: (a) upon power-up and (b) after the receipt of the STOP bit and the completion of any internal operations.

MEMORY RESET: After an interruption in protocol, power loss or system reset, any 2-wire part can be reset by following these steps:

1. Clock up to 9 cycles.
2. Look for SDA high in each cycle while SCL is high.
3. Create a start condition.

Bus Timing

SCL: Serial Clock, SDA: Serial Data I/O

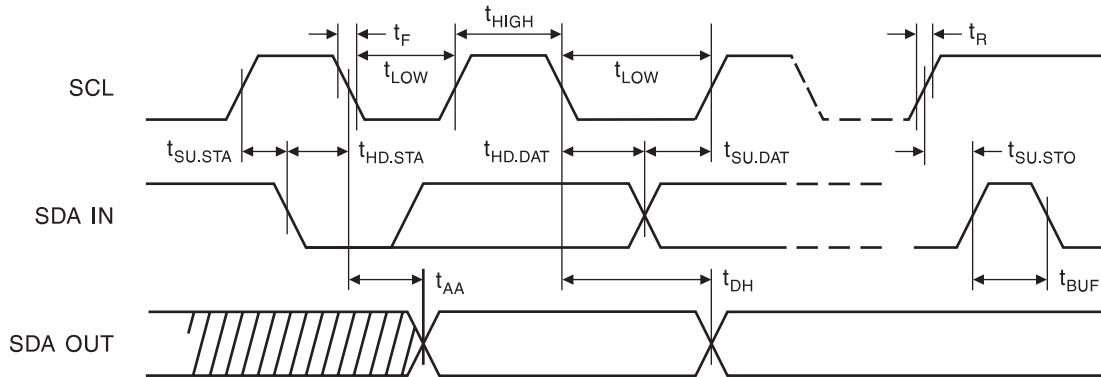

Write Cycle Timing

SCL: Serial Clock, SDA: Serial Data I/O

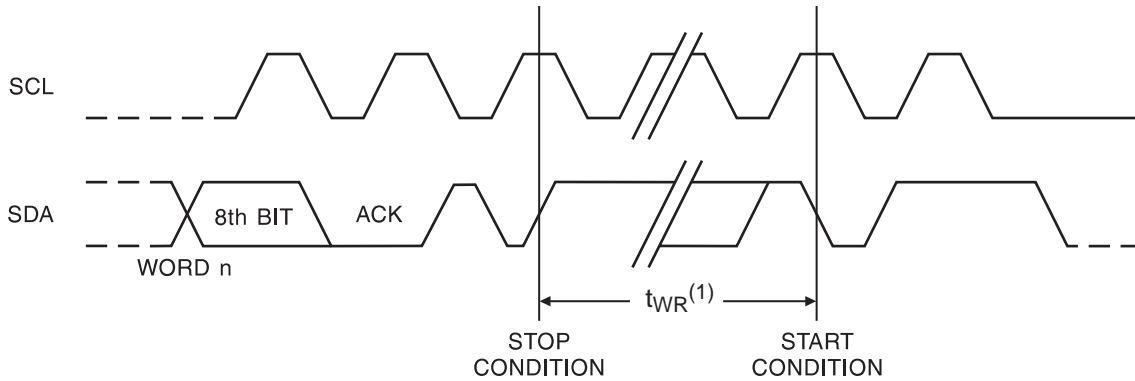

Note: 1. The write cycle time t_{WR} is the time from a valid stop condition of a write sequence to the end of the internal clear/write cycle.

Data Validity

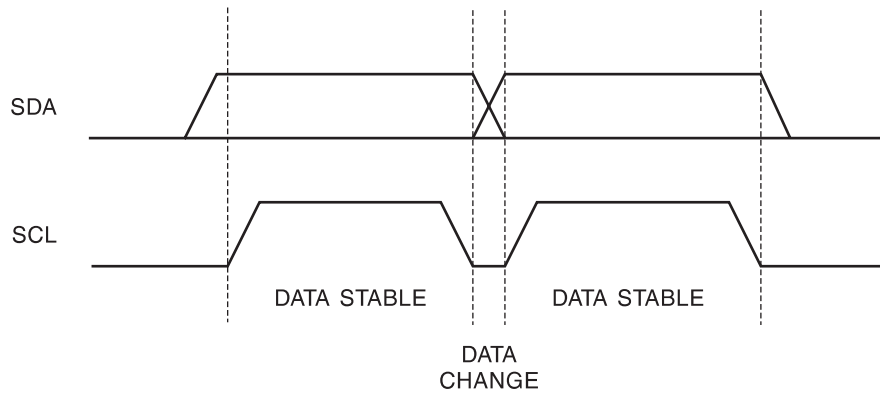

Start and Stop Definition

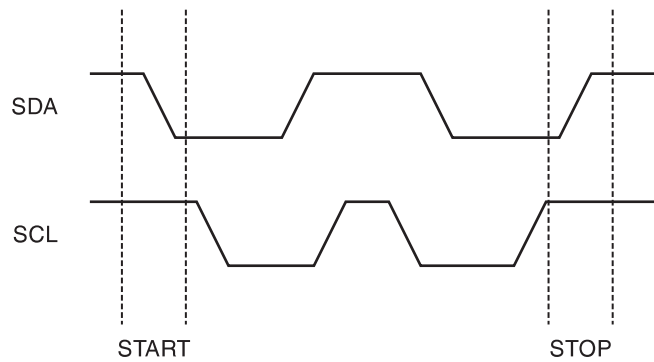

Output Acknowledge

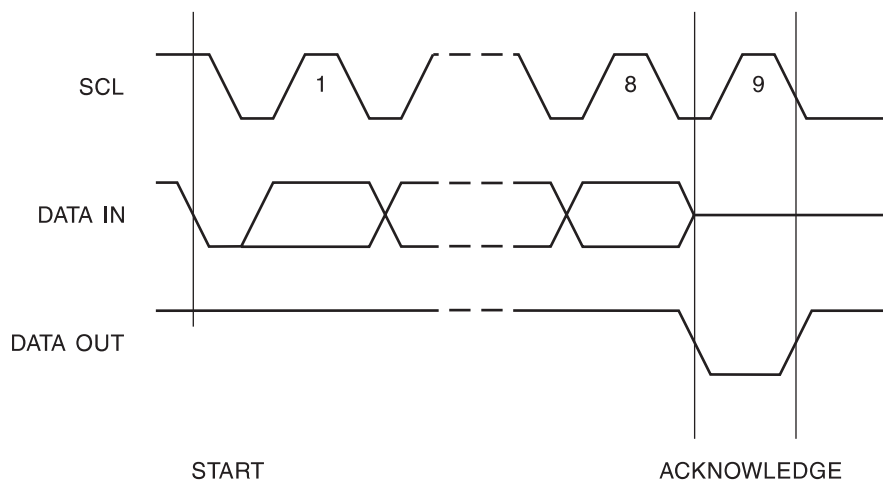

Device Addressing

The 1K, 2K, 4K, 8K and 16K EEPROM devices all require an 8-bit device address word following a start condition to enable the chip for a read or write operation (refer to Figure 1).

The device address word consists of a mandatory one, zero sequence for the first four most significant bits as shown. This is common to all the EEPROM devices.

The next 3 bits are the A2, A1 and A0 device address bits for the 1K/2K EEPROM. These 3 bits must compare to their corresponding hard-wired input pins.

The 4K EEPROM only uses the A2 and A1 device address bits with the third bit being a memory page address bit. The two device address bits must compare to their corresponding hard-wired input pins. The A0 pin is no connect.

The 8K EEPROM only uses the A2 device address bit with the next 2 bits being for memory page addressing. The A2 bit must compare to its corresponding hard-wired input pin. The A1 and A0 pins are no connect.

The 16K does not use any device address bits but instead the 3 bits are used for memory page addressing. These page addressing bits on the 4K, 8K and 16K devices should be considered the most significant bits of the data word address which follows. The A0, A1 and A2 pins are no connect.

The eighth bit of the device address is the read/write operation select bit. A read operation is initiated if this bit is high and a write operation is initiated if this bit is low.

Upon a compare of the device address, the EEPROM will output a zero. If a compare is not made, the chip will return to a standby state.

Write Operations

BYTE WRITE: A write operation requires an 8-bit data word address following the device address word and acknowledgment. Upon receipt of this address, the EEPROM will again respond with a zero and then clock in the first 8-bit data word. Following receipt of the 8-bit data word, the EEPROM will output a zero and the addressing device, such as a microcontroller, must terminate the write sequence with a stop condition. At this time the EEPROM enters an internally timed write cycle, t_{WR} , to the nonvolatile memory. All inputs are disabled during this write cycle and the EEPROM will not respond until the write is complete (refer to Figure 2).

PAGE WRITE: The 1K/2K EEPROM is capable of an 8-byte page write, and the 4K, 8K and 16K devices are capable of 16-byte page writes.

A page write is initiated the same as a byte write, but the microcontroller does not send a stop condition after the first data word is clocked in. Instead, after the EEPROM acknowledges receipt of the first data word, the microcontroller can transmit up to seven (1K/2K) or fifteen (4K, 8K, 16K) more data words. The EEPROM will respond with a zero after each data word received. The microcontroller must terminate the page write sequence with a stop condition (refer to Figure 3).

The data word address lower three (1K/2K) or four (4K, 8K, 16K) bits are internally incremented following the receipt of each data word. The higher data word address bits are not incremented, retaining the memory page row location. When the word address, internally generated, reaches the page boundary, the following byte is placed at the beginning of the same page. If more than eight (1K/2K) or sixteen (4K, 8K, 16K) data words are transmitted to the EEPROM, the data word address will “roll over” and previous data will be overwritten.

ACKNOWLEDGE POLLING: Once the internally timed write cycle has started and the EEPROM inputs are disabled, acknowledge polling can be initiated. This involves sending a start condition followed by the device address word. The read/write bit is representative of the operation desired. Only if the internal write cycle has completed will the EEPROM respond with a zero allowing the read or write sequence to continue.

Read Operations

Read operations are initiated the same way as write operations with the exception that the read/write select bit in the device address word is set to one. There are three read operations: current address read, random address read and sequential read.

CURRENT ADDRESS READ: The internal data word address counter maintains the last address accessed during the last read or write operation, incremented by one. This address stays valid between operations as long as the chip power is maintained. The address “roll over” during read is from the last byte of the last memory page to the first byte of the first page. The address “roll over” during write is from the last byte of the current page to the first byte of the same page.

Once the device address with the read/write select bit set to one is clocked in and acknowledged by the EEPROM, the current address data word is serially clocked out. The microcontroller does not respond with an input zero but does generate a following stop condition (refer to Figure 4).

RANDOM READ: A random read requires a “dummy” byte write sequence to load in the data word address. Once the device address word and data word address are clocked in and acknowledged by the EEPROM, the microcontroller must generate another start condition. The microcontroller now initiates a current address read by sending a device address with the read/write select bit high. The EEPROM acknowledges the device address and serially clocks out the data word. The microcontroller does not respond with a zero but does generate a following stop condition (refer to Figure 5).

SEQUENTIAL READ: Sequential reads are initiated by either a current address read or a random address read. After the microcontroller receives a data word, it responds with an acknowledge. As long as the EEPROM receives an acknowledge, it will continue to increment the data word address and serially clock out sequential data words. When the memory address limit is reached, the data word address will “roll over” and the sequential read will continue. The sequential read operation is terminated when the microcontroller does not respond with a zero but does generate a following stop condition (refer to Figure 6).

Figure 1. Device Address



Figure 2. Byte Write

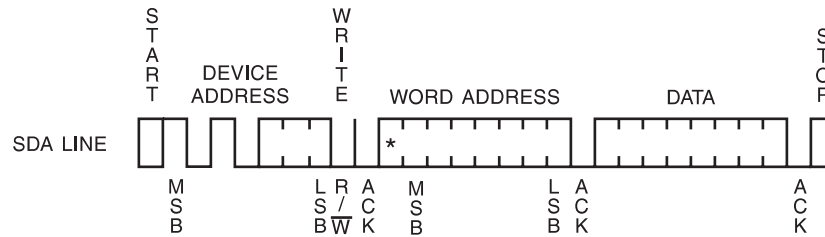
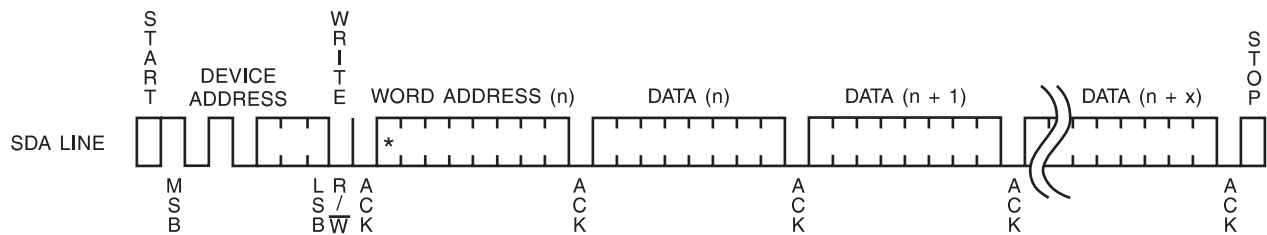

Figure 3. Page Write



(* = DON'T CARE bit for 1K)

Figure 4. Current Address Read

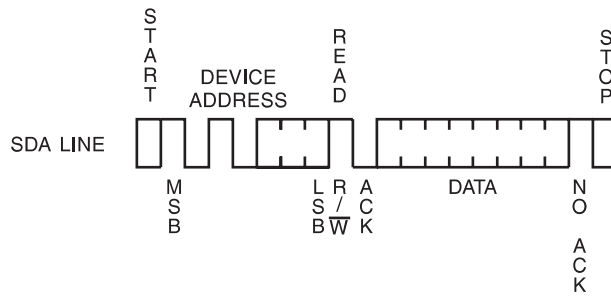
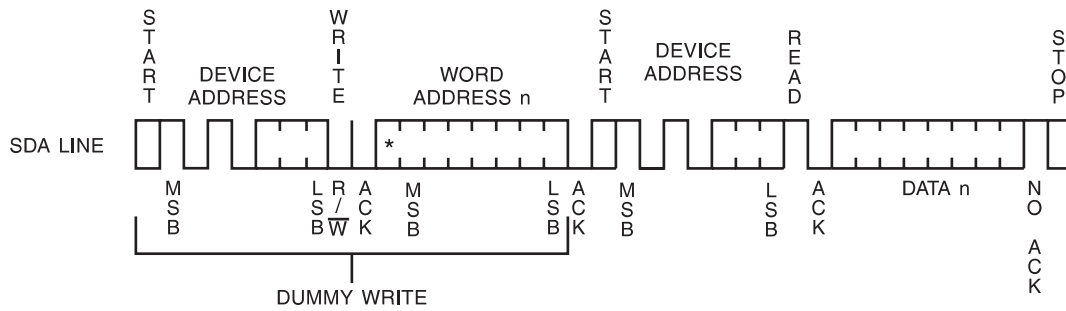
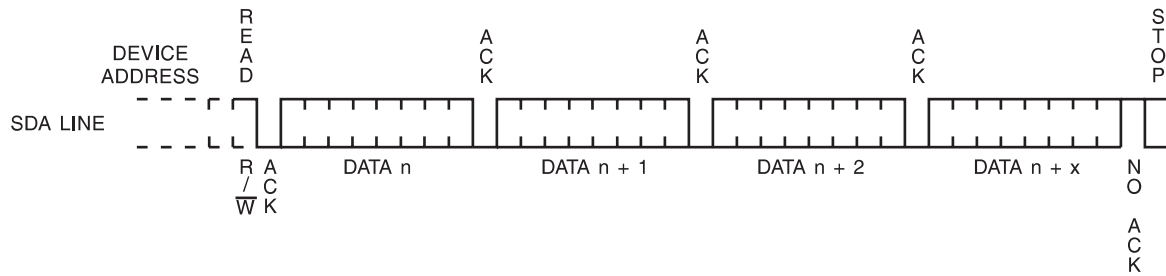

Figure 5. Random Read



(* = DON'T CARE bit for 1K)

Figure 6. Sequential Read



AT24C01A Ordering Information

Ordering Code	Package	Operation Range
AT24C01A-10PI-2.7 AT24C01A-10SI-2.7 AT24C01A-10TI-2.7 AT24C01AY1-10YI-2.7	8P3 8S1 8A2 8Y1	Industrial (-40°C to 85°C)
AT24C01A-10PI-1.8 AT24C01A-10SI-1.8 AT24C01A-10TI-1.8 AT24C01AY1-10YI-1.8	8P3 8S1 8A2 8Y1	Industrial (-40°C to 85°C)
AT24C01A-10SJ-2.7 AT24C01A-10SJ-1.8	8S1 8S1	Lead-Free/Industrial Temperature (-40°C to 85°C)
AT24C01A-10SE-2.7	8S1	High Grade/Extended Temp (-40°C to 125°C)

Note: For 2.7V devices used in the 4.5V to 5.5V range, please refer to performance values in the AC and DC characteristics table.

Package Type	
8P3	8-lead, 0.300" Wide, Plastic Dual Inline Package (PDIP)
8S1	8-lead, 0.150" Wide, Plastic Gull Wing Small Outline (JEDEC SOIC)
8A2	8-lead, 0.170" Wide, Thin Shrink Small Outline Package (TSSOP)
8Y1	8-lead, 4.90 mm x 3.00 mm Body, Dual Footprint, Non-leaded, Miniature Array Package (MAP)
Options	
-2.7	Low-voltage (2.7V to 5.5V)
-1.8	Low-voltage (1.8V to 5.5V)



AT24C02 Ordering Information

Ordering Code	Package	Operation Range
AT24C02-10PI-2.7 AT24C02N-10SI-2.7 AT24C02-10TI-2.7 AT24C02Y1-10YI-2.7	8P3 8S1 8A2 8Y1	Industrial (-40°C to 85°C)
AT24C02-10PI-1.8 AT24C02N-10SI-1.8 AT24C02-10TI-1.8 AT24C02Y1-10YI-1.8	8P3 8S1 8A2 8Y1	Industrial (-40°C to 85°C)
AT24C02N-10SJ-2.7 AT24C02N-10SJ-1.8	8S1 8S1	Lead-Free/Industrial Temperature (-40°C to 85°C)
AT24C02N-10SE-2.7	8S1	High Grade/Extended Temp (-40°C to 125°C)

Note: For 2.7V devices used in the 4.5V to 5.5V range, please refer to performance values in the AC and DC characteristics table.

Package Type	
8P3	8-lead, 0.300" Wide, Plastic Dual Inline Package (PDIP)
8S1	8-lead, 0.150" Wide, Plastic Gull Wing Small Outline (JEDEC SOIC)
8A2	8-lead, 0.170" Wide, Thin Shrink Small Outline Package (TSSOP)
8Y1	8-lead, 4.90 mm x 3.00 mm Body, Dual Footprint, Non-leaded, Miniature Array Package (MAP)
Options	
-2.7	Low-voltage (2.7V to 5.5V)
-1.8	Low-voltage (1.8V to 5.5V)

AT24C04 Ordering Information

Ordering Code	Package	Operation Range
AT24C04-10PI-2.7 AT24C04N-10SI-2.7 AT24C04-10TI-2.7 AT24C04Y1-10YI-2.7	8P3 8S1 8A2 8Y1	Industrial (-40°C to 85°C)
AT24C04-10PI-1.8 AT24C04N-10SI-1.8 AT24C04-10TI-1.8 AT24C04Y1-10YI-1.8	8P3 8S1 8A2 8Y1	Industrial (-40°C to 85°C)
AT24C04N-10SJ-2.7 AT24C04N-10SJ-1.8	8S1 8S1	Lead-Free/Industrial Temperature (-40°C to 85°C)
AT24C04N-10SE-2.7	8S1	High Grade/Extended Temp (-40°C to 125°C)

Note: For 2.7V devices used in the 4.5V to 5.5V range, please refer to performance values in the AC and DC characteristics table.

Package Type	
8P3	8-lead, 0.300" Wide, Plastic Dual Inline Package (PDIP)
8S1	8-lead, 0.150" Wide, Plastic Gull Wing Small Outline (JEDEC SOIC)
8A2	8-lead, 0.170" Wide, Thin Shrink Small Outline Package (TSSOP)
8Y1	8-lead, 4.90 mm x 3.00 mm Body, Dual Footprint, Non-leaded, Miniature Array Package (MAP)
Options	
-2.7	Low-voltage (2.7V to 5.5V)
-1.8	Low-voltage (1.8V to 5.5V)



AT24C08 Ordering Information

Ordering Code	Package	Operation Range
AT24C08-10PI-2.7 AT24C08N-10SI-2.7 AT24C08-10TI-2.7	8P3 8S1 8A2	Industrial (-40°C to 85°C)
AT24C08-10PI-1.8 AT24C08N-10SI-1.8 AT24C08-10TI-1.8	8P3 8S1 8A2	Industrial (-40°C to 85°C)

Note: For 2.7V devices used in the 4.5V to 5.5V range, please refer to performance values in the AC and DC characteristics table.

Package Type	
8P3	8-lead, 0.300" Wide, Plastic Dual Inline Package (PDIP)
8S1	8-lead, 0.150" Wide, Plastic Gull Wing Small Outline (JEDEC SOIC)
8A2	8-lead, 0.170" Wide, Thin Shrink Small Outline Package (TSSOP)
Options	
-2.7	Low-voltage (2.7V to 5.5V)
-1.8	Low-voltage (1.8V to 5.5V)

AT24C16 Ordering Information

Ordering Code	Package	Operation Range
AT24C16-10PI-2.7 AT24C16N-10SI-2.7 AT24C16-10TI-2.7	8P3 8S1 8A2	Industrial (-40°C to 85°C)
AT24C16-10PI-1.8 AT24C16N-10SI-1.8 AT24C16-10TI-1.8	8P3 8S1 8A2	Industrial (-40°C to 85°C)

Note: For 2.7V devices used in the 4.5V to 5.5V range, please refer to performance values in the AC and DC characteristics table.

Package Type	
8P3	8-lead, 0.300" Wide, Plastic Dual Inline Package (PDIP)
8S1	8-lead, 0.150" Wide, Plastic Gull Wing Small Outline (JEDEC SOIC)
8A2	8-lead, 0.170" Wide, Thin Shrink Small Outline Package (TSSOP)
Options	
-2.7	Low-voltage (2.7V to 5.5V)
-1.8	Low-voltage (1.8V to 5.5V)

Packaging Information

8P3 – PDIP

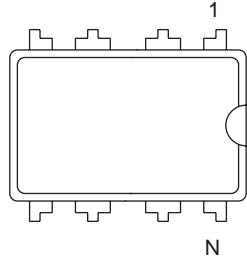

Top View

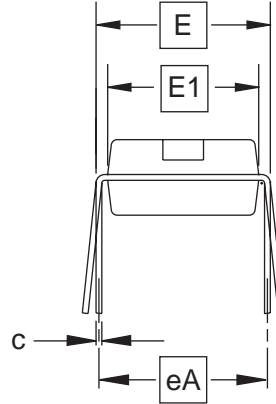

End View

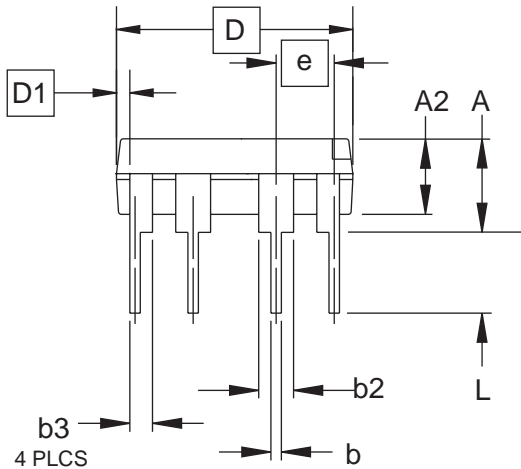

Side View

COMMON DIMENSIONS
(Unit of Measure = inches)

SYMBOL	MIN	NOM	MAX	NOTE
A			0.210	2
A2	0.115	0.130	0.195	
b	0.014	0.018	0.022	5
b2	0.045	0.060	0.070	6
b3	0.030	0.039	0.045	6
c	0.008	0.010	0.014	
D	0.355	0.365	0.400	3
D1	0.005			3
E	0.300	0.310	0.325	4
E1	0.240	0.250	0.280	3
e	0.100 BSC			
eA	0.300 BSC			4
L	0.115	0.130	0.150	2

- Notes:
1. This drawing is for general information only; refer to JEDEC Drawing MS-001, Variation BA for additional information.
 2. Dimensions A and L are measured with the package seated in JEDEC seating plane Gauge GS-3.
 3. D, D1 and E1 dimensions do not include mold Flash or protrusions. Mold Flash or protrusions shall not exceed 0.010 inch.
 4. E and eA measured with the leads constrained to be perpendicular to datum.
 5. Pointed or rounded lead tips are preferred to ease insertion.
 6. b2 and b3 maximum dimensions do not include Dambar protrusions. Dambar protrusions shall not exceed 0.010 (0.25 mm).

01/09/02



2325 Orchard Parkway
San Jose, CA 95131

TITLE

8P3, 8-lead, 0.300" Wide Body, Plastic Dual
In-line Package (PDIP)

DRAWING NO.

8P3

REV.

B

8S1 – JEDEC SOIC

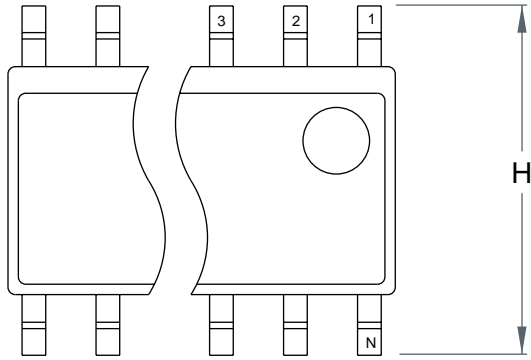

Top View

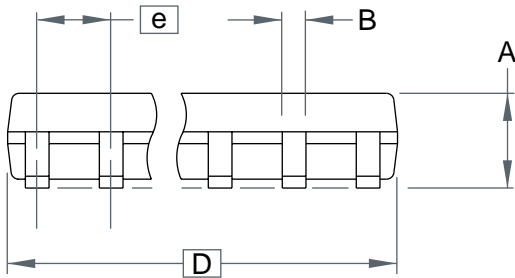

Side View

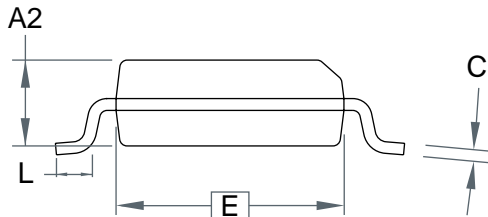

End View

COMMON DIMENSIONS
(Unit of Measure = mm)

SYMBOL	MIN	NOM	MAX	NOTE
A	-	-	1.75	
B	-	-	0.51	
C	-	-	0.25	
D	-	-	5.00	
E	-	-	4.00	
e	1.27 BSC			
H	-	-	6.20	
L	-	-	1.27	

Note: This drawing is for general information only. Refer to JEDEC Drawing MS-012 for proper dimensions, tolerances, datums, etc.

10/10/01



2325 Orchard Parkway
San Jose, CA 95131

TITLE
8S1, 8-lead (0.150" Wide Body), Plastic Gull Wing
Small Outline (JEDEC SOIC)

DRAWING NO.
8S1

REV.
A



8A2 – TSSOP

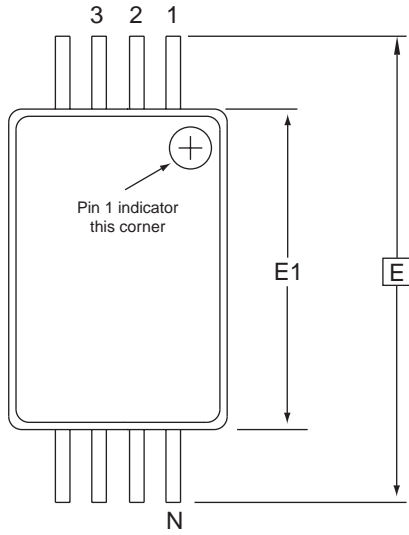

Top View

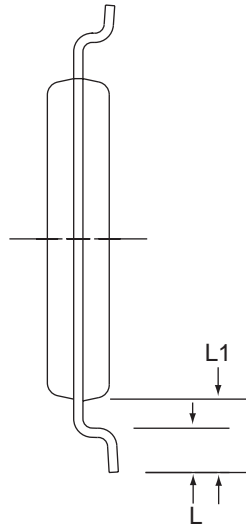

End View

COMMON DIMENSIONS
(Unit of Measure = mm)

SYMBOL	MIN	NOM	MAX	NOTE
D	2.90	3.00	3.10	2, 5
E	6.40 BSC			
E1	4.30	4.40	4.50	3, 5
A	–	–	1.20	
A2	0.80	1.00	1.05	
b	0.19	–	0.30	4
e	0.65 BSC			
L	0.45	0.60	0.75	
L1	1.00 REF			

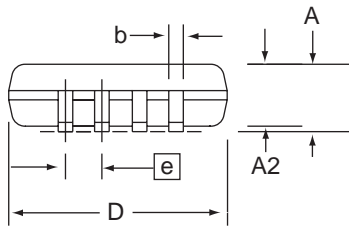

Side View

- Notes:
1. This drawing is for general information only. Refer to JEDEC Drawing MO-153, Variation AA, for proper dimensions, tolerances, datums, etc.
 2. Dimension D does not include mold Flash, protrusions or gate burrs. Mold Flash, protrusions and gate burrs shall not exceed 0.15 mm (0.006 in) per side.
 3. Dimension E1 does not include inter-lead Flash or protrusions. Inter-lead Flash and protrusions shall not exceed 0.25 mm (0.010 in) per side.
 4. Dimension b does not include Dambar protrusion. Allowable Dambar protrusion shall be 0.08 mm total in excess of the b dimension at maximum material condition. Dambar cannot be located on the lower radius of the foot. Minimum space between protrusion and adjacent lead is 0.07 mm.
 5. Dimension D and E1 to be determined at Datum Plane H.

5/30/02



2325 Orchard Parkway
San Jose, CA 95131

TITLE
8A2, 8-lead, 4.4 mm Body, Plastic
Thin Shrink Small Outline Package (TSSOP)

DRAWING NO.
8A2

REV.
B

8Y1 – MAP

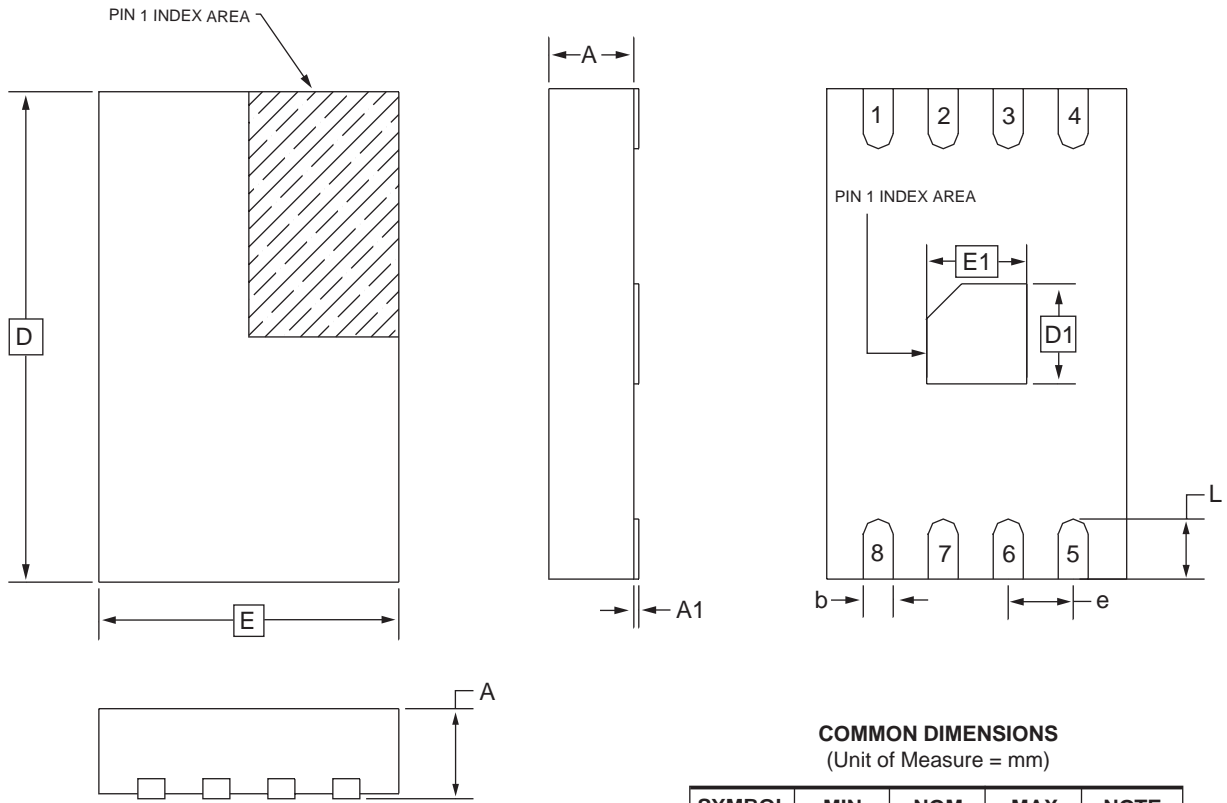

COMMON DIMENSIONS
(Unit of Measure = mm)

SYMBOL	MIN	NOM	MAX	NOTE
A	-	-	0.90	
A1	0.00	-	0.05	
D	4.70	4.90	5.10	
E	2.80	3.00	3.20	
D1	0.85	1.00	1.15	
E1	0.85	1.00	1.15	
b	0.25	0.30	0.35	
e	0.65 TYP			
L	0.50	0.60	0.70	

7/25/02

ATMEL 2325 Orchard Parkway
San Jose, CA 95131

TITLE
8Y1, 8-lead (4.90 x 3.00 mm Body) MSOP Array Package
(MAP) Y1

DRAWING NO.
8Y1

REV.
B



Atmel Headquarters

Corporate Headquarters

2325 Orchard Parkway
San Jose, CA 95131
USA
TEL 1(408) 441-0311
FAX 1(408) 487-2600

Europe

Atmel Sarl
Route des Arsenaux 41
Case Postale 80
CH-1705 Fribourg
Switzerland
TEL (41) 26-426-5555
FAX (41) 26-426-5500

Asia

Room 1219
Chinachem Golden Plaza
77 Mody Road Tsimshatsui
East Kowloon
Hong Kong
TEL (852) 2721-9778
FAX (852) 2722-1369

Japan

9F, Tonetsu Shinkawa Bldg.
1-24-8 Shinkawa
Chuo-ku, Tokyo 104-0033
Japan
TEL (81) 3-3523-3551
FAX (81) 3-3523-7581

Atmel Operations

Memory

2325 Orchard Parkway
San Jose, CA 95131
TEL 1(408) 441-0311
FAX 1(408) 436-4314

Microcontrollers

2325 Orchard Parkway
San Jose, CA 95131
TEL 1(408) 441-0311
FAX 1(408) 436-4314

La Chantrerie
BP 70602
44306 Nantes Cedex 3, France
TEL (33) 2-40-18-18-18
FAX (33) 2-40-18-19-60

ASIC/ASSP/Smart Cards

Zone Industrielle
13106 Rousset Cedex, France
TEL (33) 4-42-53-60-00
FAX (33) 4-42-53-60-01

1150 East Cheyenne Mtn. Blvd.
Colorado Springs, CO 80906
TEL 1(719) 576-3300
FAX 1(719) 540-1759

Scottish Enterprise Technology Park
Maxwell Building
East Kilbride G75 0QR, Scotland
TEL (44) 1355-803-000
FAX (44) 1355-242-743

RF/Automotive

Theresienstrasse 2
Postfach 3535
74025 Heilbronn, Germany
TEL (49) 71-31-67-0
FAX (49) 71-31-67-2340

1150 East Cheyenne Mtn. Blvd.
Colorado Springs, CO 80906
TEL 1(719) 576-3300
FAX 1(719) 540-1759

Biometrics/Imaging/Hi-Rel MPU/ High Speed Converters/RF Datacom

Avenue de Rochepleine
BP 123
38521 Saint-Egreve Cedex, France
TEL (33) 4-76-58-30-00
FAX (33) 4-76-58-34-80

e-mail

literature@atmel.com

Web Site

<http://www.atmel.com>

© Atmel Corporation 2003.

Atmel Corporation makes no warranty for the use of its products, other than those expressly contained in the Company's standard warranty which is detailed in Atmel's Terms and Conditions located on the Company's web site. The Company assumes no responsibility for any errors which may appear in this document, reserves the right to change devices or specifications detailed herein at any time without notice, and does not make any commitment to update the information contained herein. No licenses to patents or other intellectual property of Atmel are granted by the Company in connection with the sale of Atmel products, expressly or by implication. Atmel's products are not authorized for use as critical components in life support devices or systems.

ATMEL® is a registered trademark of Atmel.

Terms and product names in this document may be trademarks of others.



Printed on recycled paper.

0180K-SEEPR-01/03

xM