

Chip Coils

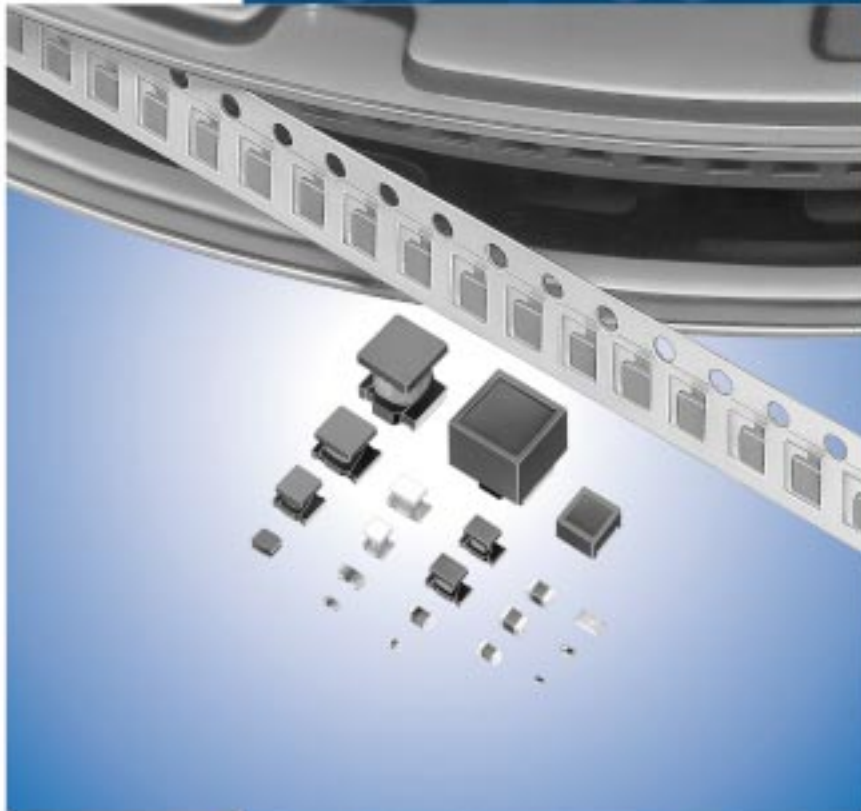

for EU RoHS Compliant

- All the products in this catalog comply with EU RoHS.
- EU RoHS is "the European Directive 2002/95/EC on the Restriction of the Use of Certain Hazardous Substances in Electrical and Electronic Equipment".
- For more details, please refer to our website 'Murata's Approach for EU RoHS' (<http://www.murata.com/info/rohs.html>).

CONTENTS

Part Numbering	_____	2	1
Product Guide	_____	4	2
Selection Guide	_____	5	3
High Frequency			
1 Monolithic Type	LQG15H/LQG18H Series _____	6	4
2 Film Type	LQP02T/LQP03T/LQP15T/LQP15M/LQP18M Series —	13	5
3 Wire Wound Type	LQW04A/LQW15A/LQW18A Series _____	32	6
4 Wire Wound Type	LQW2BH/LQW31H Series _____	46	7
5 Wire Wound Type	LQW21H/LQH31H Series _____	51	8
for General Use			
6 Monolithic Type	LQM18N/LQM21N Series _____	53	9
7 Wire Wound Type	LQH31M/LQH32M/LQH43M (N) Series —	57	10
for DC-DC Converter			
8 Monolithic Type	LQM21P/LQM2MP/LQM2HP/LQM31P Series —	64	11
9 Wire Wound Type	LQH2MC/LQH3NP/LQH32P/LQH55P Series —	71	12
for Choke			
10 Monolithic Type	LQM18F/LQM21D/LQM21F/LQM31F Series —	79	13
11 Wire Wound Type	LQH31C/LQH32C/LQH43C Series _____	85	14
12 Wire Wound/Large Current Type	LQH55D/LQH66S Series _____	90	15
△Caution/Notice	_____	94	16
Chip Coils (Soldering and Mounting)	_____	96	17
Packaging	_____	101	18
Design Kits	_____	104	19
Information	_____	119	20

● Part Numbering

Chip Coils (SMD)

(Part Number)

LQ	H	32	M	N	331	K	2	3	L
①	②	③	④	⑤	⑥	⑦	⑧	⑨	⑩

① Product ID

Product ID	
LQ	Chip Coils

② Structure

Code	Structure
G	Monolithic Type (Air-core Coil)
H	Wire Wound Type (Ferrite Core)
M	Monolithic Type (Ferrite Core)
P	Film Type
W	Wire Wound Type (Air-core Coil)

③ Dimensions (L×W)

Code	Dimensions (L×W)	EIA
02	0.4×0.2mm	01005
03	0.6×0.3mm	0201
04	0.8×0.4mm	03015
15	1.0×0.5mm	0402
18	1.6×0.8mm	0603
21	2.0×1.25mm	0805
2B	2.0×1.5mm	0805
2M	2.0×1.6mm	0806
2H	2.5×2.0mm	1008
3N	3.0×3.0mm	1212
31	3.2×1.6mm	1206
32	3.2×2.5mm	1210
43	4.5×3.2mm	1812
55	5.7×5.0mm (5.87×5.2mm)	2220
66	6.3×6.3mm	2525

④ Applications and Characteristics

Code	Series	Applications and Characteristics
H	LQG	Monolithic Air-core
N	LQM	for Resonant Circuit
D		for Choke (Low-current DC Power Supplies)
F	LQP	for Choke (DC Power Supplies)
M		Film Type
T	LQW	Film Type (Low DC Resistance Type)
A		High Q Type (UHF-SHF)
H	LQH	High Q Type (VHF-UHF)
N		for Resonant Circuit
M		for Resonant Circuit (Coating Type)
D		for Choke
C		for Choke (Coating Type)
S		for Choke (Magnetically Shielded Type)
H		for High-frequency Resonant Circuit
P	LQM/LQH	for Power Line

⑤ Category

Code	Category
N	Standard Type
S	

⑥ Inductance

Expressed by three-digit alphanumerics. The unit is micro-henry (μH). The first and second figures are significant digits, and the third figure expresses the number of zeros which follow the two figures. If there is a decimal point, it is expressed by the capital letter "R". In this case, all figures are significant digits. If inductance is less than 0.1μH, the inductance code is expressed by a combination of two figures and the capital letter "N", and the unit of inductance is nano-henry (nH).

The capital letter "N" indicates the unit of "nH", and also expresses a decimal point. In this case, all figures are significant digits.

⑦ Inductance Tolerance

Code	Inductance Tolerance
B	±0.1nH
C	±0.2nH
D	±0.5nH
G	±2%
H	±3%
J	±5%
K	±10%
M	±20%
N	±30%
S	±0.3nH
W	±0.05nH

⑧ Features (Except LQH□□P/LQM□□P)

Code	Features	Series
0	Standard Type	LQG/LQP/LQW/LQM*1/LQH*2
1	High-Q/ Low DC Resistance	LQW15A/18A/2BH
	Standard Type	LQM21N
2	Standard Type	LQH32C/32M
3	Low DC Resistance	LQH32C
5	Low Profile Type	LQH2MC/32C
7	Large Current Type	LQM21F
8	Low DC Resistance /Large Current Type	

*1 Except LQM21N Series

*2 Except LQH32 Series

Continued on the following page. 

Continued from the preceding page.

(Part Number)

LQ	H	32	M	N	331	K	2	3	L
①	②	③	④	⑤	⑥	⑦	⑧	⑨	⑩

⑧ Thickness (LQH□□P/LQM□□P Only)

Code	Dimensions (T)
C	0.5mm
E	0.7mm
0	0.85mm
G	0.9mm
J	1.1mm
M	1.4mm
N	1.55mm
R	1.85mm

⑨ Electrode (Except LQH□□P/LQM□□P)

•Lead (Pb) Free

Code	Electrode	Series
0	Sn	LQG18H/LQP03T/LQW□□A/LQM
2		LQG15H/LQP02T/LQP03T/LQP15T/ LQP□□M/LQH2MC
3	LF Solder	LQW□□H/LQH (Except LQH2MC)
4	Au	LQP03T

⑩ Specification (LQH□□P/LQM□□P Only)

Code	Specification
0	Standard Type

⑪ Packaging

Code	Packaging	Series
K	Embossed Taping (ø330mm Reel)	LQH*1 /LQW□□H*6 /LQM31F/LQM21*2
L	Embossed Taping (ø180mm Reel)	LQH/LQW□□H/LQM31F/LQM21*2 /LQM31P/LQM2HP/LQM2MP
B	Bulk	LQH2MC/LQW/LQG/LQM/LQP
J	Paper Taping (ø330mm Reel)	LQW18A/LQG/LQM18/LQM21*3 /LQP*5
D	Paper Taping (ø180mm Reel)	LQW□□A/LQG/LQM18/LQM21*4 /LQP

*1 Except LQH2MC/LQH32P/LQH3NP/LQH43C

*2 LQM21D(2.2 - 47μH)/LQM21F(4.7 - 47μH)/LQM21N(2.7 - 4.7μH) only.

*3 LQM21D(1.0 - 10μH)/LQM21F(1.0 - 2.2μH)/LQM21N(0.1 - 2.2μH) only.

*4 LQM21D(1.0 - 10μH)/LQM21F(1.0 - 2.2μH)/LQM21N(0.1 - 2.2μH)/LQM21P only.

*5 Except LQP02T/15T

*6 Except LQW21H

Product Guide

Murata's LQ□ series of chip coils consists of compact, high-performance inductors. Their innovative coil and case structures mean low DC resistance and outstanding high-frequency characteristics. The series is designed for a variety of applications, facilitating component selection for individual circuit requirements.

Application	Part Number	Structure	Dimensions		Inductance Range (H)												
			(mm)	EIA Code	1n	10n	100n	1μ	10μ	100μ	1m	10m					
High Frequency Range	LQG15H	Monolithic	1.0 -0.5	0402	1.0nH							270nH					
	LQG18H		1.6 -0.8	0603	1.2nH							100nH					
	Tight Inductance Tolerance	LQP02T	Film	0.4 -0.2	01005	0.4nH							10nH				
		LQP03T_00		0.6 -0.3	0201	0.6nH							56nH				
		LQP03T_02		0.6 -0.3	0201						68nH		120nH				
		LQP03T_04		0.6 -0.3	0201	0.6nH							56nH				
		LQP15T		1.0 -0.5	0402	1.0nH							18nH				
		LQP15M		1.0 -0.5	0402	1.0nH							33nH				
		LQP18M	1.6 -0.8	0603	1.3nH							100nH					
		LQW04A	Wire Wound (air core)	0.8 -0.4	03015	1.1nH							33nH				
		LQW15A		1.0 -0.5	0402	1.3nH							120nH				
		LQW18A		1.6 -0.8	0603	2.2nH							470nH				
		LQW2BH		2.0 -1.5	0805	2.7nH							470nH				
		LQW31H		3.2 -1.6	1206						8.8nH			100nH			
		LQW21H	Wire Wound (ferrite core)	2.0 -1.25	0805								0.47μH		2.2μH		
		LQH31H		3.2 -1.6	1206						54nH			880nH			
		General Frequency Range	LQM18N	Magnetically Shielded Monolithic	1.6 -0.8	0603						47nH			2200nH		
LQM21N	2.0 -1.25		0805							0.1μH			4.7μH				
LQH31M	Wire Wound (ferrite core)		3.2 -1.6	1206						0.15μH			100μH				
LQH32M			3.2 -2.5	1210						1.0μH			560μH				
LQH43M(N)			4.5 -3.2	1812						1.0μH			2200μH				
DC-DC Converter Type	LQM21P	Magnetically Shielded Monolithic	2.0 -1.25	0805						0.47μH		2.2μH					
	LQM2MP_G0		2.0 -1.6	0806						0.47μH		4.7μH					
	LQM2HP_J0		2.5 -2.0	1008						1.0μH		3.3μH					
	LQM2HP_G0		2.5 -2.0	1008						0.47μH		4.7μH					
	LQM2HP_E0		2.5 -2.0	1008								0.56μH					
	LQM31P_00		3.2 -1.6	1206						0.47μH		4.7μH					
	LQM31P_C0	3.2 -1.6	1206						0.47μH		2.2μH						
	LQH2MC_02	Wire Wound	2.0 -1.6	0806						1.0μH		82μH					
	LQH2MC_52		2.0 -1.6	0806						1.0μH		10μH					
	LQH3NP_M0		3.0 -3.0	1212						1.0μH		100μH					
	LQH3NP_G0		3.0 -3.0	1212						1.0μH		250μH					
	LQH32P		3.2 -2.5	1210						0.47μH		22μH					
	LQH55P		5.87 -5.2	2220						1.2μH		22μH					
Chokes	LQM18F		Magnetically Shielded Monolithic	1.6 -0.8	0603						1.0μH		10μH				
	LQM21D	2.0 -1.25		0805						1.0μH		47μH					
	LQM21F	2.0 -1.25		0805						1.0μH		47μH					
	LQM31F	3.2 -1.6	1206								10μH						
	LQH31C	Wire Wound	3.2 -1.6	1206						0.12μH		100μH					
	LQH32C		3.2 -2.5	1210						0.15μH		560μH					
	LQH32C_53		3.2 -2.5	1210						1.0μH		100μH					
	LQH43C		4.5 -3.2	1812						1.0μH		470μH					
	LQH55D		5.7 -5.0	2220						0.12μH		10000μH					
	LQH66S	Magnetically Shielded	6.3 -6.3	2525						0.27μH		10000μH					

CAUTION : Use rosin-based flux, but not strong acidic flux (with chlorine content exceeding 0.2wt%) when soldering chip coil.
Do not use water-soluble flux.

Selection Guide

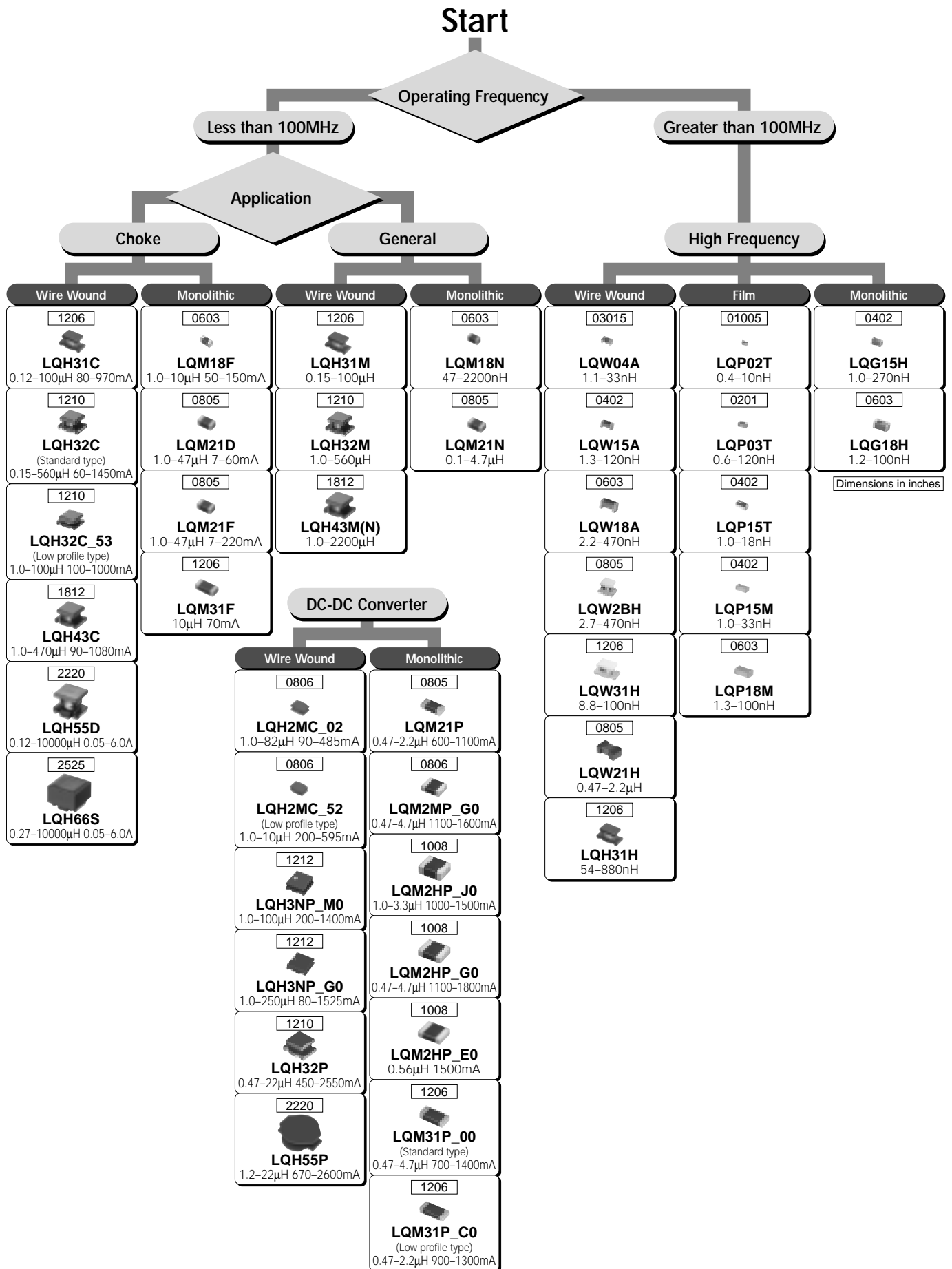

Chip Coils for High Frequency Monolithic Type



LQG15HN Series (0402 Size)

LQG15HN series is comprised of chip inductors specifically designed for high frequency applications. LQG15H series is designed to realize stable characteristics in high frequency range applying integrated multilayer process. The integrated multilayer process enables a wide range of inductance values with tight tolerance.

■ Features

1. High-Q, stable inductance in high frequency is achieved by the original structure that minimizes stray capacitance. It is suitable for the high frequency circuits of mobile communication equipment.
2. The small size of LQG15H (1.0x0.5x0.5mm) is suitable for small and low profile mobile equipment.
3. The external electrodes with nickel barrier structure provide excellent solder heat resistance.
4. Wide variation in inductance value
 - 1-10nH (E24 step)
 - 10-120nH (E12 step)

■ Applications

1. High frequency circuits of mobile phones such as PA, ANT, VCO, SAW, etc.
2. Mobile phones
3. "Bluetooth"
4. W-LAN
5. High frequency circuits in general

■ Dimensions

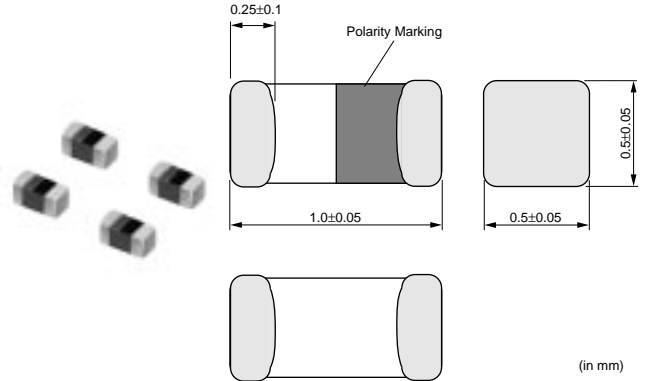

■ Rated Value (□: packaging code)

Part Number	Inductance	Test Frequency	Rated Current	Max. of DC Resistance	Q (min.)	Test Frequency	Self Resonance Frequency (min.)
LQG15HN1N0S02□	1.0nH±0.3nH	100MHz	300mA	0.10ohm	8	100MHz	6000MHz
LQG15HN1N1S02□	1.1nH±0.3nH	100MHz	300mA	0.10ohm	8	100MHz	6000MHz
LQG15HN1N2S02□	1.2nH±0.3nH	100MHz	300mA	0.10ohm	8	100MHz	6000MHz
LQG15HN1N3S02□	1.3nH±0.3nH	100MHz	300mA	0.10ohm	8	100MHz	6000MHz
LQG15HN1N5S02□	1.5nH±0.3nH	100MHz	300mA	0.10ohm	8	100MHz	6000MHz
LQG15HN1N6S02□	1.6nH±0.3nH	100MHz	300mA	0.10ohm	8	100MHz	6000MHz
LQG15HN1N8S02□	1.8nH±0.3nH	100MHz	300mA	0.10ohm	8	100MHz	6000MHz
LQG15HN2N0S02□	2.0nH±0.3nH	100MHz	300mA	0.12ohm	8	100MHz	6000MHz
LQG15HN2N2S02□	2.2nH±0.3nH	100MHz	300mA	0.15ohm	8	100MHz	6000MHz
LQG15HN2N4S02□	2.4nH±0.3nH	100MHz	300mA	0.16ohm	8	100MHz	6000MHz
LQG15HN2N7S02□	2.7nH±0.3nH	100MHz	300mA	0.17ohm	8	100MHz	6000MHz
LQG15HN3N0S02□	3.0nH±0.3nH	100MHz	300mA	0.18ohm	8	100MHz	6000MHz
LQG15HN3N3S02□	3.3nH±0.3nH	100MHz	300mA	0.19ohm	8	100MHz	6000MHz
LQG15HN3N6S02□	3.6nH±0.3nH	100MHz	300mA	0.19ohm	8	100MHz	6000MHz
LQG15HN3N9S02□	3.9nH±0.3nH	100MHz	300mA	0.19ohm	8	100MHz	6000MHz
LQG15HN4N3S02□	4.3nH±0.3nH	100MHz	300mA	0.21ohm	8	100MHz	6000MHz

Operating Temperature Range: -55°C to +125°C Only for reflow soldering.

Continued on the following page.

Continued from the preceding page.

Part Number	Inductance	Test Frequency	Rated Current	Max. of DC Resistance	Q (min.)	Test Frequency	Self Resonance Frequency (min.)
LQG15HN4N7S02□	4.7nH±0.3nH	100MHz	300mA	0.23ohm	8	100MHz	6000MHz
LQG15HN5N1S02□	5.1nH±0.3nH	100MHz	300mA	0.24ohm	8	100MHz	6000MHz
LQG15HN5N6S02□	5.6nH±0.3nH	100MHz	300mA	0.26ohm	8	100MHz	5300MHz
LQG15HN6N2S02□	6.2nH±0.3nH	100MHz	300mA	0.27ohm	8	100MHz	4300MHz
LQG15HN6N8J02□	6.8nH±5%	100MHz	300mA	0.29ohm	8	100MHz	4200MHz
LQG15HN7N5J02□	7.5nH±5%	100MHz	300mA	0.31ohm	8	100MHz	3900MHz
LQG15HN8N2J02□	8.2nH±5%	100MHz	300mA	0.33ohm	8	100MHz	3600MHz
LQG15HN9N1J02□	9.1nH±5%	100MHz	300mA	0.34ohm	8	100MHz	3400MHz
LQG15HN10NJ02□	10nH±5%	100MHz	300mA	0.35ohm	8	100MHz	3200MHz
LQG15HN12NJ02□	12nH±5%	100MHz	300mA	0.41ohm	8	100MHz	2800MHz
LQG15HN15NJ02□	15nH±5%	100MHz	300mA	0.46ohm	8	100MHz	2300MHz
LQG15HN18NJ02□	18nH±5%	100MHz	300mA	0.51ohm	8	100MHz	2100MHz
LQG15HN22NJ02□	22nH±5%	100MHz	300mA	0.58ohm	8	100MHz	1800MHz
LQG15HN27NJ02□	27nH±5%	100MHz	300mA	0.67ohm	8	100MHz	1600MHz
LQG15HN33NJ02□	33nH±5%	100MHz	200mA	0.67ohm	8	100MHz	1500MHz
LQG15HN39NJ02□	39nH±5%	100MHz	200mA	1.06ohm	8	100MHz	1200MHz
LQG15HN47NJ02□	47nH±5%	100MHz	200mA	1.15ohm	8	100MHz	1000MHz
LQG15HN56NJ02□	56nH±5%	100MHz	200mA	1.20ohm	8	100MHz	800MHz
LQG15HN68NJ02□	68nH±5%	100MHz	180mA	1.25ohm	8	100MHz	800MHz
LQG15HN82NJ02□	82nH±5%	100MHz	150mA	1.60ohm	8	100MHz	600MHz
LQG15HNR10J02□	100nH±5%	100MHz	150mA	1.60ohm	8	100MHz	600MHz
LQG15HNR12J02□	120nH±5%	100MHz	150mA	1.60ohm	8	100MHz	600MHz

Operating Temperature Range: -55°C to +125°C Only for reflow soldering.

■ Q - Frequency Characteristics (Typ.)

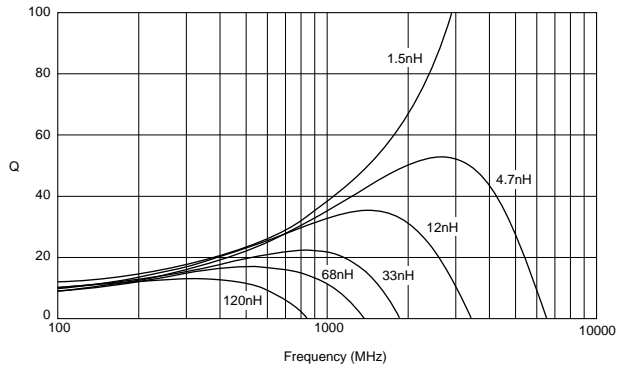

■ Inductance - Frequency Characteristics (Typ.)

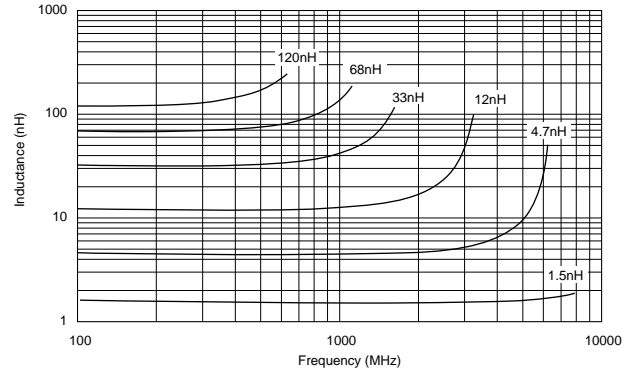

Chip Coils for High Frequency Monolithic Type



LQG15HS Series (0402 Size)

LQG15HS series is comprised of chip inductors specifically designed for high frequency applications. LQG15H series is designed to realize stable characteristics in high frequency range applying integrated multilayer process. The integrated multilayer process enables a wide range of inductance values with tight tolerance. Since recent mobile phones install color LCDs and camera modules, the power consumption becomes higher. In order to reduce power consumption a low DC resistance is strongly required. LQG15HS has achieved the lowest DC resistance.

■ Dimensions

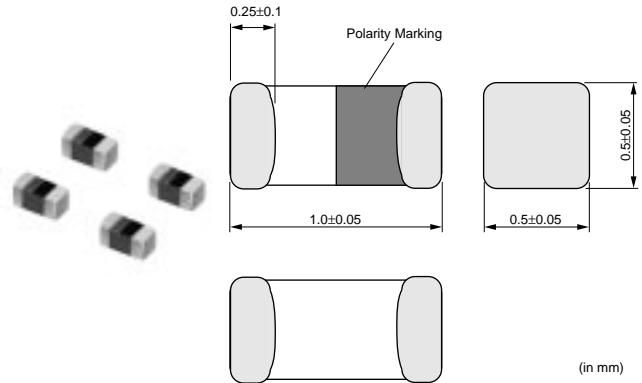

■ Features

1. High-Q, stable inductance in high frequency is achieved by the original structure that minimizes stray capacitance. It is suitable for the high frequency circuits of mobile communication equipment.
2. The small size of LQG15H (1.0x0.5x0.5mm) is suitable for small and low profile mobile equipment.
3. The external electrodes with nickel barrier structure provide excellent solder heat resistance.
4. Wide variation in inductance value
 - 1-10nH (E24 step)
 - 10-270nH (E12 step)

■ Applications

1. High frequency circuits of mobile phones such as PA, ANT, VCO, SAW, etc.
2. Mobile phones
3. "Bluetooth"
4. W-LAN
5. High frequency circuits in general

■ Supplements

For the product with tight inductance tolerance, please contact our local sales or product engineers.

■ Rated Value (□: packaging code)

Part Number	Inductance	Test Frequency	Rated Current	Max. of DC Resistance	Q (min.)	Test Frequency	Self Resonance Frequency (min.)
LQG15HS1N0S02□	1.0nH±0.3nH	100MHz	300mA	0.07ohm	8	100MHz	10000MHz
LQG15HS1N1S02□	1.1nH±0.3nH	100MHz	300mA	0.09ohm	8	100MHz	6000MHz
LQG15HS1N2S02□	1.2nH±0.3nH	100MHz	300mA	0.09ohm	8	100MHz	6000MHz
LQG15HS1N3S02□	1.3nH±0.3nH	100MHz	300mA	0.09ohm	8	100MHz	6000MHz
LQG15HS1N5S02□	1.5nH±0.3nH	100MHz	300mA	0.1ohm	8	100MHz	6000MHz
LQG15HS1N6S02□	1.6nH±0.3nH	100MHz	300mA	0.1ohm	8	100MHz	6000MHz
LQG15HS1N8S02□	1.8nH±0.3nH	100MHz	300mA	0.1ohm	8	100MHz	6000MHz

Operating Temperature Range: -55°C to +125°C Only for reflow soldering.

Continued on the following page.

Continued from the preceding page.

1

Part Number	Inductance	Test Frequency	Rated Current	Max. of DC Resistance	Q (min.)	Test Frequency	Self Resonance Frequency (min.)
LQG15HS2N0S02□	2.0nH±0.3nH	100MHz	300mA	0.1ohm	8	100MHz	6000MHz
LQG15HS2N2S02□	2.2nH±0.3nH	100MHz	300mA	0.12ohm	8	100MHz	6000MHz
LQG15HS2N4S02□	2.4nH±0.3nH	100MHz	300mA	0.15ohm	8	100MHz	6000MHz
LQG15HS2N7S02□	2.7nH±0.3nH	100MHz	300mA	0.15ohm	8	100MHz	6000MHz
LQG15HS3N0S02□	3.0nH±0.3nH	100MHz	300mA	0.17ohm	8	100MHz	6000MHz
LQG15HS3N3S02□	3.3nH±0.3nH	100MHz	300mA	0.17ohm	8	100MHz	6000MHz
LQG15HS3N6S02□	3.6nH±0.3nH	100MHz	300mA	0.18ohm	8	100MHz	6000MHz
LQG15HS3N9S02□	3.9nH±0.3nH	100MHz	300mA	0.18ohm	8	100MHz	6000MHz
LQG15HS4N3S02□	4.3nH±0.3nH	100MHz	300mA	0.18ohm	8	100MHz	6000MHz
LQG15HS4N7S02□	4.7nH±0.3nH	100MHz	300mA	0.18ohm	8	100MHz	6000MHz
LQG15HS5N1S02□	5.1nH±0.3nH	100MHz	300mA	0.2ohm	8	100MHz	5300MHz
LQG15HS5N6S02□	5.6nH±0.3nH	100MHz	300mA	0.2ohm	8	100MHz	4500MHz
LQG15HS6N2S02□	6.2nH±0.3nH	100MHz	300mA	0.22ohm	8	100MHz	4500MHz
LQG15HS6N8J02□	6.8nH±5%	100MHz	300mA	0.24ohm	8	100MHz	4500MHz
LQG15HS7N5J02□	7.5nH±5%	100MHz	300mA	0.24ohm	8	100MHz	4200MHz
LQG15HS8N2J02□	8.2nH±5%	100MHz	300mA	0.24ohm	8	100MHz	3700MHz
LQG15HS9N1J02□	9.1nH±5%	100MHz	300mA	0.26ohm	8	100MHz	3400MHz
LQG15HS10NJ02□	10nH±5%	100MHz	300mA	0.26ohm	8	100MHz	3400MHz
LQG15HS12NJ02□	12nH±5%	100MHz	300mA	0.28ohm	8	100MHz	3000MHz
LQG15HS15NJ02□	15nH±5%	100MHz	300mA	0.32ohm	8	100MHz	2500MHz
LQG15HS18NJ02□	18nH±5%	100MHz	300mA	0.36ohm	8	100MHz	2200MHz
LQG15HS22NJ02□	22nH±5%	100MHz	300mA	0.42ohm	8	100MHz	1900MHz
LQG15HS27NJ02□	27nH±5%	100MHz	300mA	0.46ohm	8	100MHz	1700MHz
LQG15HS33NJ02□	33nH±5%	100MHz	200mA	0.58ohm	8	100MHz	1600MHz
LQG15HS39NJ02□	39nH±5%	100MHz	200mA	0.65ohm	8	100MHz	1200MHz
LQG15HS47NJ02□	47nH±5%	100MHz	200mA	0.72ohm	8	100MHz	1000MHz
LQG15HS56NJ02□	56nH±5%	100MHz	200mA	0.82ohm	8	100MHz	800MHz
LQG15HS68NJ02□	68nH±5%	100MHz	180mA	0.92ohm	8	100MHz	800MHz
LQG15HS82NJ02□	82nH±5%	100MHz	150mA	1.2ohm	8	100MHz	700MHz
LQG15HSR10J02□	100nH±5%	100MHz	150mA	1.25ohm	8	100MHz	600MHz
LQG15HSR12J02□	120nH±5%	100MHz	150mA	1.3ohm	8	100MHz	600MHz
LQG15HSR15J02□	150nH±5%	100MHz	140mA	2.99ohm	8	100MHz	550MHz
LQG15HSR18J02□	180nH±5%	100MHz	130mA	3.38ohm	8	100MHz	500MHz
LQG15HSR22J02□	220nH±5%	100MHz	120mA	3.77ohm	8	100MHz	450MHz
LQG15HSR27J02□	270nH±5%	100MHz	110mA	4.94ohm	8	100MHz	400MHz

Operating Temperature Range: -55°C to +125°C Only for reflow soldering.

■ Q - Frequency Characteristics (Typ.)

■ Inductance - Frequency Characteristics (Typ.)

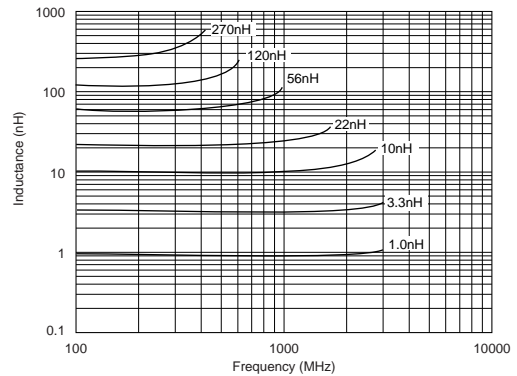
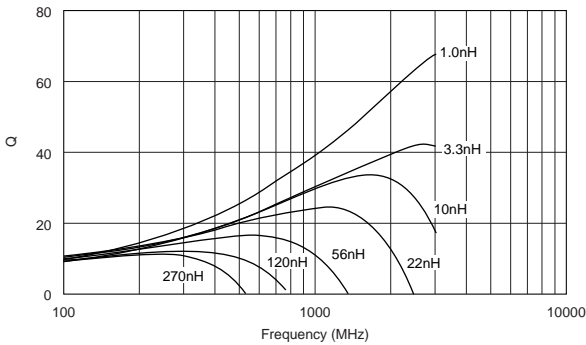

Continued on the following page. ↗

Continued from the preceding page.

■ Reference Data

E4991&16197A

Part Number	Inductance (nH) 100MHz	Q (typ.)					Rdc (Ω typ.)	SRF (MHz typ.)
		800MHz	900MHz	1.8GHz	2.0GHz	2.4GHz		
LQG15HS1N0S02	1.0	32	34	51	54	57	0.03	11700
LQG15HS1N1S02	1.1	35	37	59	62	64		10000
LQG15HS1N2S02	1.2	34	36	56	58	60		8600
LQG15HS1N3S02	1.3	34	36	56	57	58		7000
LQG15HS1N5S02	1.5	31	34	50	53	55		9700
LQG15HS1N6S02	1.6	31	33	50	52	54	0.04	8600
LQG15HS1N8S02	1.8	31	33	48	49	50		7500
LQG15HS2N0S02	2.0	31	32	47	48	49		6400
LQG15HS2N2S02	2.2	32	34	48	49	50	0.05	6200
LQG15HS2N4S02	2.4	32	34	51	52	52	0.07	10000
LQG15HS2N7S02	2.7	31	33	49	50	50	0.08	8700
LQG15HS3N0S02	3.0	32	34	49	51	50	0.09	8000
LQG15HS3N3S02	3.3	31	33	46	47	46		6700
LQG15HS3N6S02	3.6	31	33	45	47	46	0.10	8000
LQG15HS3N9S02	3.9	31	33	49	47	46		7500
LQG15HS4N3S02	4.3	31	33	44	45	44	0.12	6500
LQG15HS4N7S02	4.7	31	33	42	43	42		6200
LQG15HS5N1S02	5.1	31	33	44	45	42	0.13	5800
LQG15HS5N6S02	5.6	30	32	41	40	38		5000
LQG15HS6N2S02	6.2	29	31	41	41	38	0.16	5100
LQG15HS6N8J02	6.8	29	30	40	40	37	0.17	4900
LQG15HS7N5J02	7.5	28	29	38	37	34		4500
LQG15HS8N2J02	8.2	27	29	35	34	29		4100
LQG15HS9N1J02	9.1	27	29	36	35	31	0.18	3900
LQG15HS10NJ02	10	27	29	35	33	28		3200
LQG15HS12NJ02	12	26	27	28	24	18	0.22	2900
LQG15HS15NJ02	15	26	27	25	21	13		2800
LQG15HS18NJ02	18	25	25	22	18	-	0.26	2500
LQG15HS22NJ02	22	23	24	16	-	-	0.30	2000
LQG15HS27NJ02	27	21	21	-	-	-	0.33	1900
LQG15HS33NJ02	33	20	20	-	-	-	0.40	1700
LQG15HS39NJ02	39	19	18	-	-	-	0.44	1500
LQG15HS47NJ02	47	17	16	-	-	-	0.48	1300
LQG15HS56NJ02	56	15	13	-	-	-	0.55	1200
LQG15HS68NJ02	68	12	10	-	-	-	0.63	1100
LQG15HS82NJ02	82	9	6	-	-	-	0.77	900
LQG15HSR10J02	100	-	-	-	-	-	0.92	800
LQG15HSR12J02	120	-	-	-	-	-	1.00	

Chip Coils for High Frequency Monolithic Type



LQG18H Series (0603 Size)

LQG18H series is designed to realize stable characteristics in high frequency range applying integrated multilayer process.

■ Dimensions

■ Features

1. High-Q, stable inductance in high frequency is achieved by the original structure that minimizes stray capacitance. It is suitable for the high frequency circuits of mobile communication equipment.
2. Small size of LQG18H (1.6x0.8x0.8mm) is suitable for small, handy equipment, especially for card size equipment.
3. The external electrodes with nickel barrier structure provide excellent solder heat resistance.

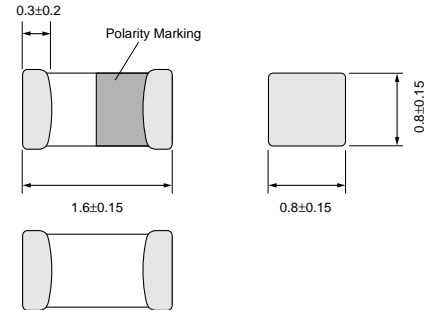

(in mm)

■ Applications

1. High frequency circuits of mobile phones such as PA, ANT, VCO, SAW, etc.
2. Mobile phones
3. "Bluetooth"
4. W-LAN
5. High frequency circuits in general

■ Rated Value (□: packaging code)

Part Number	Inductance	Test Frequency	Rated Current	Max. of DC Resistance	Q (min.)	Test Frequency	Self Resonance Frequency (min.)
LQG18HN1N2S00□	1.2nH±0.3nH	100MHz	500mA	0.10ohm	12	100MHz	6000MHz
LQG18HN1N5S00□	1.5nH±0.3nH	100MHz	500mA	0.10ohm	12	100MHz	6000MHz
LQG18HN1N8S00□	1.8nH±0.3nH	100MHz	500mA	0.10ohm	12	100MHz	6000MHz
LQG18HN2N2S00□	2.2nH±0.3nH	100MHz	500mA	0.10ohm	12	100MHz	6000MHz
LQG18HN2N7S00□	2.7nH±0.3nH	100MHz	500mA	0.15ohm	12	100MHz	6000MHz
LQG18HN3N3S00□	3.3nH±0.3nH	100MHz	500mA	0.15ohm	12	100MHz	6000MHz
LQG18HN3N9S00□	3.9nH±0.3nH	100MHz	450mA	0.15ohm	12	100MHz	6000MHz
LQG18HN4N7S00□	4.7nH±0.3nH	100MHz	450mA	0.20ohm	12	100MHz	6000MHz
LQG18HN5N6S00□	5.6nH±0.3nH	100MHz	430mA	0.20ohm	12	100MHz	5000MHz
LQG18HN6N8J00□	6.8nH±5%	100MHz	430mA	0.25ohm	12	100MHz	5000MHz
LQG18HN8N2J00□	8.2nH±5%	100MHz	400mA	0.25ohm	12	100MHz	4000MHz
LQG18HN10NJ00□	10nH±5%	100MHz	400mA	0.30ohm	12	100MHz	3500MHz
LQG18HN12NJ00□	12nH±5%	100MHz	400mA	0.35ohm	12	100MHz	3000MHz
LQG18HN15NJ00□	15nH±5%	100MHz	350mA	0.40ohm	12	100MHz	2800MHz
LQG18HN18NJ00□	18nH±5%	100MHz	350mA	0.45ohm	12	100MHz	2600MHz
LQG18HN22NJ00□	22nH±5%	100MHz	300mA	0.50ohm	12	100MHz	2300MHz
LQG18HN27NJ00□	27nH±5%	100MHz	300mA	0.55ohm	12	100MHz	2000MHz
LQG18HN33NJ00□	33nH±5%	100MHz	300mA	0.60ohm	12	100MHz	1700MHz
LQG18HN39NJ00□	39nH±5%	100MHz	300mA	0.65ohm	12	100MHz	1500MHz
LQG18HN47NJ00□	47nH±5%	100MHz	300mA	0.70ohm	12	100MHz	1200MHz
LQG18HN56NJ00□	56nH±5%	100MHz	300mA	0.75ohm	12	100MHz	1100MHz

Operating Temperature Range: -40°C to +85°C Only for reflow soldering.

Continued on the following page.

Continued from the preceding page.

Part Number	Inductance	Test Frequency	Rated Current	Max. of DC Resistance	Q (min.)	Test Frequency	Self Resonance Frequency (min.)
LQG18HN68NJ00□	68nH±5%	100MHz	300mA	0.80ohm	12	100MHz	1000MHz
LQG18HN82NJ00□	82nH±5%	100MHz	300mA	0.85ohm	12	100MHz	900MHz
LQG18HNR10J00□	100nH±5%	100MHz	300mA	0.90ohm	12	100MHz	800MHz

Operating Temperature Range: -40°C to +85°C Only for reflow soldering.

■ Q - Frequency Characteristics (Typ.)

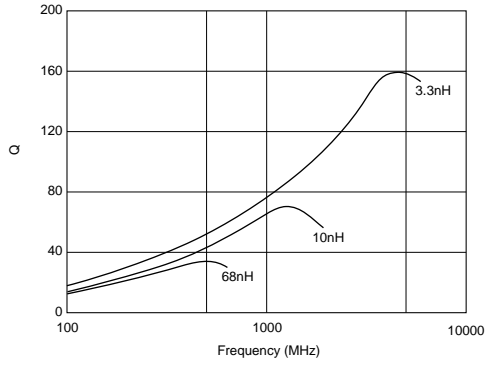

■ Inductance - Frequency Characteristics (Typ.)

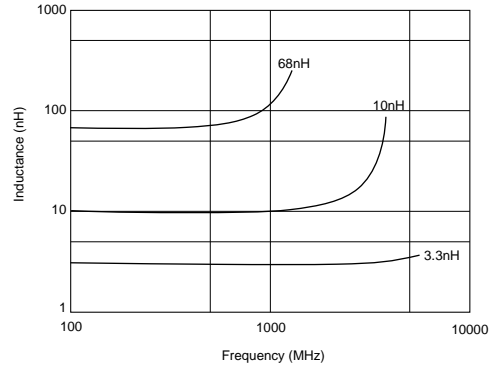

Chip Coils for High Frequency Film Type



LQP02T Series (01005 Size)

LQP02T series is ultra small size (01005) chip inductor, which is developed using highly advanced micro processing technology. This inductor reduces 50% of mounting area from that of 0201 size inductor. High Q value and stable inductance characteristics in high frequency range contributes to high performance equipment.

■ Dimensions

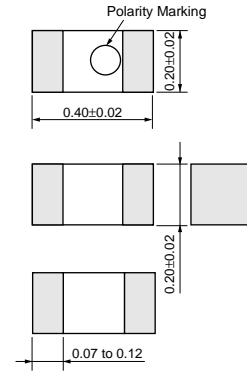

(in mm)

■ Features

1. Ultra small size 0.4x0.2x0.2mm
2. High Q value and stable inductance
3. Inductance value 0.4 to 10nH
4. Inductance tolerance (+-0.3nH, +-5%)

■ Applications

1. High frequency circuits of mobile phones such as PA, ANT, VCO, SAW etc.
2. Mobile phones such as GSM, CDMA, PDC etc.
3. Digital TV Tuner
4. W-LAN
5. "Bluetooth"
6. High frequency circuits in general

■ Rated Value (□: packaging code)

Part Number	Inductance	Test Frequency	Rated Current	Max. of DC Resistance	Q (min.)	Test Frequency	Self Resonance Frequency (min.)
LQP02TN0N4S02□	0.4nH±0.3nH	500MHz	160mA	0.60ohm	8	500MHz	6000MHz
LQP02TN0N5S02□	0.5nH±0.3nH	500MHz	160mA	0.60ohm	8	500MHz	6000MHz
LQP02TN0N6S02□	0.6nH±0.3nH	500MHz	160mA	0.60ohm	8	500MHz	6000MHz
LQP02TN0N7S02□	0.7nH±0.3nH	500MHz	160mA	0.60ohm	8	500MHz	6000MHz
LQP02TN0N8S02□	0.8nH±0.3nH	500MHz	160mA	0.60ohm	8	500MHz	6000MHz
LQP02TN0N9S02□	0.9nH±0.3nH	500MHz	160mA	0.60ohm	8	500MHz	6000MHz
LQP02TN1N0S02□	1.0nH±0.3nH	500MHz	110mA	0.90ohm	8	500MHz	6000MHz
LQP02TN1N1S02□	1.1nH±0.3nH	500MHz	110mA	0.90ohm	8	500MHz	6000MHz
LQP02TN1N2S02□	1.2nH±0.3nH	500MHz	110mA	0.90ohm	8	500MHz	6000MHz
LQP02TN1N3S02□	1.3nH±0.3nH	500MHz	110mA	0.90ohm	8	500MHz	6000MHz
LQP02TN1N5S02□	1.5nH±0.3nH	500MHz	110mA	0.90ohm	8	500MHz	6000MHz
LQP02TN1N6S02□	1.6nH±0.3nH	500MHz	110mA	0.90ohm	8	500MHz	6000MHz
LQP02TN1N8S02□	1.8nH±0.3nH	500MHz	100mA	1.35ohm	8	500MHz	6000MHz
LQP02TN2N0S02□	2.0nH±0.3nH	500MHz	100mA	1.35ohm	8	500MHz	6000MHz
LQP02TN2N2S02□	2.2nH±0.3nH	500MHz	100mA	1.35ohm	8	500MHz	6000MHz
LQP02TN2N4S02□	2.4nH±0.3nH	500MHz	100mA	1.35ohm	8	500MHz	6000MHz
LQP02TN2N7S02□	2.7nH±0.3nH	500MHz	100mA	1.35ohm	8	500MHz	6000MHz
LQP02TN3N0S02□	3.0nH±0.3nH	500MHz	100mA	1.35ohm	8	500MHz	6000MHz
LQP02TN3N3S02□	3.3nH±0.3nH	500MHz	90mA	1.65ohm	8	500MHz	6000MHz
LQP02TN3N6S02□	3.6nH±0.3nH	500MHz	90mA	1.65ohm	8	500MHz	6000MHz
LQP02TN3N9S02□	3.9nH±0.3nH	500MHz	90mA	1.65ohm	8	500MHz	6000MHz
LQP02TN4N3S02□	4.3nH±0.3nH	500MHz	90mA	1.65ohm	8	500MHz	6000MHz

Operating Temperature Range: -40°C to +85°C Only for reflow soldering.

Continued on the following page.

Continued from the preceding page.

Part Number	Inductance	Test Frequency	Rated Current	Max. of DC Resistance	Q (min.)	Test Frequency	Self Resonance Frequency (min.)
LQP02TN4N7S02□	4.7nH±0.3nH	500MHz	80mA	2.10ohm	8	500MHz	6000MHz
LQP02TN5N1S02□	5.1nH±0.3nH	500MHz	80mA	2.10ohm	8	500MHz	6000MHz
LQP02TN5N6S02□	5.6nH±0.3nH	500MHz	70mA	2.40ohm	8	500MHz	6000MHz
LQP02TN6N2J02□	6.2nH±5%	500MHz	70mA	2.40ohm	8	500MHz	5500MHz
LQP02TN6N8J02□	6.8nH±5%	500MHz	70mA	2.85ohm	8	500MHz	5500MHz
LQP02TN7N5J02□	7.5nH±5%	500MHz	70mA	2.85ohm	8	500MHz	4500MHz
LQP02TN8N2J02□	8.2nH±5%	500MHz	70mA	3.15ohm	8	500MHz	4500MHz
LQP02TN9N1J02□	9.1nH±5%	500MHz	70mA	3.15ohm	8	500MHz	4000MHz
LQP02TN10NJ02□	10nH±5%	500MHz	70mA	3.60ohm	8	500MHz	4000MHz

Operating Temperature Range: -40°C to +85°C Only for reflow soldering.

■ Q - Frequency Characteristics (Typ.)

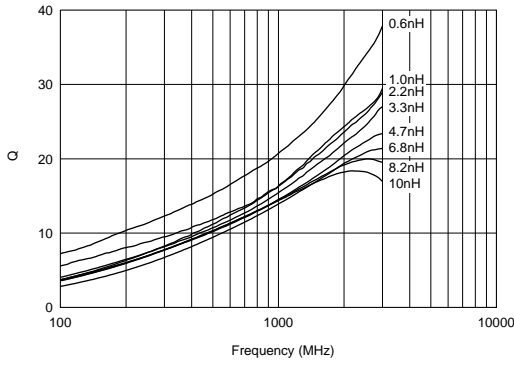

■ Inductance - Frequency Characteristics (Typ.)

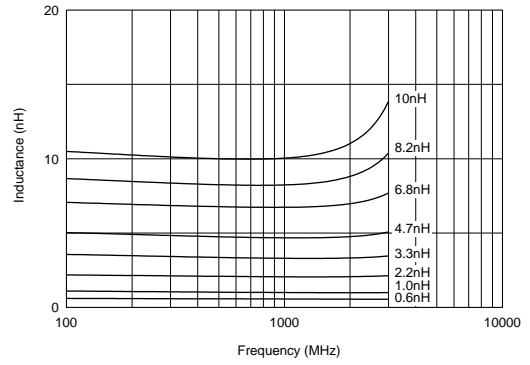

Continued on the following page.

 Continued from the preceding page.

■ Reference Data

E4991A & 16197A

Part Number	Inductance (nH) (Typ.)					Q (Typ.)				
	800MHz	900MHz	1.8GHz	2.0GHz	2.4GHz	800MHz	900MHz	1.8GHz	2.0GHz	2.4GHz
LQP02TN0N4	0.4	0.4	0.4	0.4	0.4	15	16	26	28	30
LQP02TN0N5	0.5	0.5	0.5	0.5	0.5	15	16	24	26	28
LQP02TN0N6	0.6	0.6	0.6	0.6	0.6	15	16	24	26	28
LQP02TN0N7	0.7	0.7	0.7	0.7	0.7	15	15	23	24	26
LQP02TN0N8	0.8	0.8	0.8	0.8	0.8	14	15	23	24	26
LQP02TN0N9	0.9	0.9	0.9	0.9	0.9	14	15	23	24	26
LQP02TN1N0	1.0	1.0	1.0	1.0	1.0	14	15	23	24	26
LQP02TN1N1	1.1	1.1	1.1	1.1	1.1	14	15	23	24	26
LQP02TN1N2	1.2	1.2	1.2	1.2	1.2	14	15	23	24	26
LQP02TN1N3	1.3	1.3	1.3	1.3	1.3	14	15	23	24	26
LQP02TN1N5	1.5	1.5	1.5	1.5	1.5	14	15	23	24	26
LQP02TN1N6	1.6	1.6	1.6	1.6	1.6	14	15	23	24	26
LQP02TN1N8	1.8	1.8	1.8	1.8	1.8	14	15	23	24	26
LQP02TN2N0	2.0	2.0	2.0	2.0	2.0	14	15	22	23	25
LQP02TN2N2	2.2	2.2	2.2	2.2	2.2	14	15	22	23	25
LQP02TN2N4	2.4	2.4	2.4	2.4	2.4	14	15	22	23	25
LQP02TN2N7	2.7	2.7	2.7	2.7	2.7	14	15	22	23	25
LQP02TN3N0	3.0	3.0	3.0	3.0	3.0	13	14	21	22	23
LQP02TN3N3	3.3	3.3	3.3	3.3	3.3	13	14	21	22	24
LQP02TN3N6	3.6	3.6	3.6	3.6	3.6	13	14	20	21	23
LQP02TN3N9	3.9	3.9	3.9	3.9	3.9	13	14	20	21	23
LQP02TN4N3	4.3	4.3	4.3	4.3	4.3	13	14	19	20	22
LQP02TN4N7	4.7	4.7	4.7	4.7	4.8	13	14	19	20	22
LQP02TN5N1	5.1	5.1	5.0	5.1	5.2	13	14	18	19	21
LQP02TN5N6	5.6	5.6	5.6	5.7	5.9	13	14	18	19	21
LQP02TN6N2	6.2	6.2	6.1	6.2	6.3	13	14	18	19	21
LQP02TN6N8	6.8	6.8	6.9	7.0	7.2	13	14	18	19	21
LQP02TN7N5	7.5	7.5	7.4	7.5	7.9	13	14	18	19	20
LQP02TN8N2	8.2	8.2	8.6	8.8	9.3	13	14	18	19	20
LQP02TN9N1	9.1	9.2	9.7	9.7	10.0	13	14	18	19	20
LQP02TN10N	10	10	11	11	12	13	14	17	18	18

2

Chip Coils for High Frequency Film Type



LQP03T_00/LQP03T_02 Series (0201 Size)

2

LQP03T_00 Series

LQP03T_00 series offers ultra small size using Murata's miniature manufacturing technology. By this, LQP03T_00 series contributes to miniaturization of equipment. Also, its highest class Q characteristic compared to other Monolithic inductors, enables higher performance of equipment. Furthermore, it enables easy impedance matching at both RF and IF circuits, and compact high frequency circuit designing, because it realizes 0.1nH step at 0.6 to 3.9nH and E24 step at 4.3 to 10nH.

■ Features

1. Ultra small size 0.6x0.3x0.3mm
2. High Q value in high frequency range
3. 0.1nH step
 - 0.6 to 3.9nH: +-0.1nH, +-0.2nH
 - E24 step
 - 4.3 to 10nH: +-3%
 - E12 step
 - 4.7 to 27nH: +-3%, +-5%
 - 33 to 56nH: +-5%
4. Sn Electrode

■ Applications

1. High frequency circuits of mobile phones such as PA, ANT, VCO, SAW, etc.
2. Mobile phones
3. "Bluetooth"
4. W-LAN
5. High frequency circuits in general

■ Dimensions

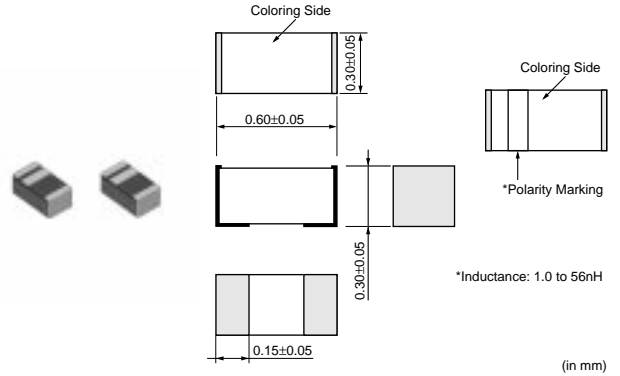

■ Rated Value (□: packaging code)

Part Number	Inductance	Test Frequency	Rated Current	Max. of DC Resistance	Q (min.)	Test Frequency	Self Resonance Frequency (min.)
LQP03TN0N6B00□	0.6nH±0.1nH	500MHz	420mA	0.08ohm	13	500MHz	6000MHz
LQP03TN0N6C00□	0.6nH±0.2nH	500MHz	420mA	0.08ohm	13	500MHz	6000MHz
LQP03TN0N7B00□	0.7nH±0.1nH	500MHz	410mA	0.09ohm	13	500MHz	6000MHz
LQP03TN0N8B00□	0.8nH±0.1nH	500MHz	410mA	0.09ohm	13	500MHz	6000MHz
LQP03TN0N8C00□	0.8nH±0.2nH	500MHz	410mA	0.09ohm	13	500MHz	6000MHz
LQP03TN0N9B00□	0.9nH±0.1nH	500MHz	400mA	0.10ohm	13	500MHz	6000MHz
LQP03TN1N0B00□	1.0nH±0.1nH	500MHz	400mA	0.10ohm	13	500MHz	6000MHz
LQP03TN1N0C00□	1.0nH±0.2nH	500MHz	400mA	0.10ohm	13	500MHz	6000MHz
LQP03TN1N1B00□	1.1nH±0.1nH	500MHz	280mA	0.13ohm	13	500MHz	6000MHz
LQP03TN1N2B00□	1.2nH±0.1nH	500MHz	280mA	0.13ohm	13	500MHz	6000MHz
LQP03TN1N2C00□	1.2nH±0.2nH	500MHz	280mA	0.13ohm	13	500MHz	6000MHz
LQP03TN1N3B00□	1.3nH±0.1nH	500MHz	280mA	0.16ohm	13	500MHz	6000MHz

Operating Temperature Range: -40°C to +85°C Only for reflow soldering.

Continued on the following page.

Continued from the preceding page.

2

Part Number	Inductance	Test Frequency	Rated Current	Max. of DC Resistance	Q (min.)	Test Frequency	Self Resonance Frequency (min.)
LQP03TN1N4B00□	1.4nH±0.1nH	500MHz	280mA	0.16ohm	13	500MHz	6000MHz
LQP03TN1N5B00□	1.5nH±0.1nH	500MHz	280mA	0.16ohm	13	500MHz	6000MHz
LQP03TN1N5C00□	1.5nH±0.2nH	500MHz	280mA	0.16ohm	13	500MHz	6000MHz
LQP03TN1N6B00□	1.6nH±0.1nH	500MHz	280mA	0.16ohm	13	500MHz	6000MHz
LQP03TN1N7B00□	1.7nH±0.1nH	500MHz	280mA	0.16ohm	13	500MHz	6000MHz
LQP03TN1N8B00□	1.8nH±0.1nH	500MHz	280mA	0.16ohm	13	500MHz	6000MHz
LQP03TN1N8C00□	1.8nH±0.2nH	500MHz	280mA	0.16ohm	13	500MHz	6000MHz
LQP03TN1N9B00□	1.9nH±0.1nH	500MHz	220mA	0.18ohm	13	500MHz	6000MHz
LQP03TN2N0B00□	2.0nH±0.1nH	500MHz	220mA	0.18ohm	13	500MHz	6000MHz
LQP03TN2N1B00□	2.1nH±0.1nH	500MHz	220mA	0.18ohm	13	500MHz	6000MHz
LQP03TN2N2B00□	2.2nH±0.1nH	500MHz	220mA	0.18ohm	13	500MHz	6000MHz
LQP03TN2N2C00□	2.2nH±0.2nH	500MHz	220mA	0.18ohm	13	500MHz	6000MHz
LQP03TN2N3B00□	2.3nH±0.1nH	500MHz	220mA	0.21ohm	13	500MHz	6000MHz
LQP03TN2N4B00□	2.4nH±0.1nH	500MHz	220mA	0.21ohm	13	500MHz	6000MHz
LQP03TN2N5B00□	2.5nH±0.1nH	500MHz	220mA	0.21ohm	13	500MHz	6000MHz
LQP03TN2N6B00□	2.6nH±0.1nH	500MHz	220mA	0.21ohm	13	500MHz	6000MHz
LQP03TN2N7B00□	2.7nH±0.1nH	500MHz	220mA	0.21ohm	13	500MHz	6000MHz
LQP03TN2N7C00□	2.7nH±0.2nH	500MHz	220mA	0.21ohm	13	500MHz	6000MHz
LQP03TN2N8B00□	2.8nH±0.1nH	500MHz	220mA	0.21ohm	13	500MHz	6000MHz
LQP03TN2N9B00□	2.9nH±0.1nH	500MHz	220mA	0.21ohm	13	500MHz	6000MHz
LQP03TN3N0B00□	3.0nH±0.1nH	500MHz	190mA	0.30ohm	13	500MHz	6000MHz
LQP03TN3N1B00□	3.1nH±0.1nH	500MHz	190mA	0.30ohm	13	500MHz	6000MHz
LQP03TN3N2B00□	3.2nH±0.1nH	500MHz	190mA	0.30ohm	13	500MHz	6000MHz
LQP03TN3N3B00□	3.3nH±0.1nH	500MHz	190mA	0.30ohm	13	500MHz	6000MHz
LQP03TN3N3C00□	3.3nH±0.2nH	500MHz	190mA	0.30ohm	13	500MHz	6000MHz
LQP03TN3N4B00□	3.4nH±0.1nH	500MHz	190mA	0.30ohm	13	500MHz	6000MHz
LQP03TN3N5B00□	3.5nH±0.1nH	500MHz	190mA	0.30ohm	13	500MHz	6000MHz
LQP03TN3N6B00□	3.6nH±0.1nH	500MHz	170mA	0.45ohm	13	500MHz	6000MHz
LQP03TN3N7B00□	3.7nH±0.1nH	500MHz	170mA	0.45ohm	13	500MHz	6000MHz
LQP03TN3N8B00□	3.8nH±0.1nH	500MHz	170mA	0.45ohm	13	500MHz	6000MHz
LQP03TN3N9B00□	3.9nH±0.1nH	500MHz	170mA	0.45ohm	13	500MHz	6000MHz
LQP03TN3N9C00□	3.9nH±0.2nH	500MHz	170mA	0.45ohm	13	500MHz	6000MHz
LQP03TN4N3H00□	4.3nH±3%	500MHz	160mA	0.55ohm	13	500MHz	6000MHz
LQP03TN4N7H00□	4.7nH±3%	500MHz	160mA	0.55ohm	13	500MHz	6000MHz
LQP03TN4N7J00□	4.7nH±5%	500MHz	160mA	0.55ohm	13	500MHz	6000MHz
LQP03TN5N1H00□	5.1nH±3%	500MHz	140mA	0.68ohm	13	500MHz	6000MHz
LQP03TN5N6H00□	5.6nH±3%	500MHz	140mA	0.68ohm	13	500MHz	6000MHz
LQP03TN5N6J00□	5.6nH±5%	500MHz	140mA	0.68ohm	13	500MHz	6000MHz
LQP03TN6N2H00□	6.2nH±3%	500MHz	130mA	0.75ohm	13	500MHz	6000MHz
LQP03TN6N8H00□	6.8nH±3%	500MHz	130mA	0.75ohm	13	500MHz	6000MHz
LQP03TN6N8J00□	6.8nH±5%	500MHz	130mA	0.75ohm	13	500MHz	6000MHz
LQP03TN7N5H00□	7.5nH±3%	500MHz	110mA	0.86ohm	13	500MHz	5500MHz
LQP03TN8N2H00□	8.2nH±3%	500MHz	110mA	0.86ohm	13	500MHz	5500MHz
LQP03TN8N2J00□	8.2nH±5%	500MHz	110mA	0.86ohm	13	500MHz	5500MHz
LQP03TN9N1H00□	9.1nH±3%	500MHz	100mA	1.10ohm	13	500MHz	4500MHz
LQP03TN10NH00□	10nH±3%	500MHz	100mA	1.10ohm	13	500MHz	4500MHz
LQP03TN10NJ00□	10nH±5%	500MHz	100mA	1.10ohm	13	500MHz	4500MHz
LQP03TN12NH00□	12nH±3%	500MHz	90mA	1.25ohm	11	500MHz	3700MHz
LQP03TN12NJ00□	12nH±5%	500MHz	90mA	1.25ohm	11	500MHz	3700MHz
LQP03TN15NH00□	15nH±3%	500MHz	90mA	1.40ohm	11	500MHz	3300MHz
LQP03TN15NJ00□	15nH±5%	500MHz	90mA	1.40ohm	11	500MHz	3300MHz

Operating Temperature Range: -40°C to +85°C Only for reflow soldering.

Continued on the following page. ↗

Continued from the preceding page.

Part Number	Inductance	Test Frequency	Rated Current	Max. of DC Resistance	Q (min.)	Test Frequency	Self Resonance Frequency (min.)
LQP03TN18NH00□	18nH±3%	500MHz	80mA	1.60ohm	11	500MHz	3100MHz
LQP03TN18NJ00□	18nH±5%	500MHz	80mA	1.60ohm	11	500MHz	3100MHz
LQP03TN22NH00□	22nH±3%	500MHz	70mA	2.55ohm	11	500MHz	2800MHz
LQP03TN22NJ00□	22nH±5%	500MHz	70mA	2.55ohm	11	500MHz	2800MHz
LQP03TN27NH00□	27nH±3%	500MHz	70mA	2.90ohm	11	500MHz	2500MHz
LQP03TN27NJ00□	27nH±5%	500MHz	70mA	2.90ohm	11	500MHz	2500MHz
LQP03TN33NJ00□	33nH±5%	300MHz	60mA	2.95ohm	8	300MHz	2000MHz
LQP03TN39NJ00□	39nH±5%	300MHz	60mA	3.35ohm	8	300MHz	1800MHz
LQP03TN47NJ00□	47nH±5%	300MHz	50mA	3.60ohm	8	300MHz	1600MHz
LQP03TN56NJ00□	56nH±5%	300MHz	50mA	4.30ohm	8	300MHz	1400MHz

Operating Temperature Range: -40°C to +85°C Only for reflow soldering.

■ Q - Frequency Characteristics (Typ.)

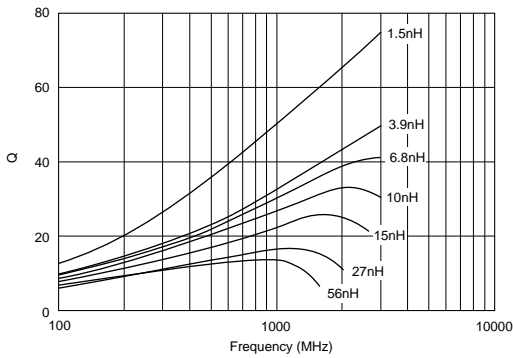

■ Inductance - Frequency Characteristics (Typ.)

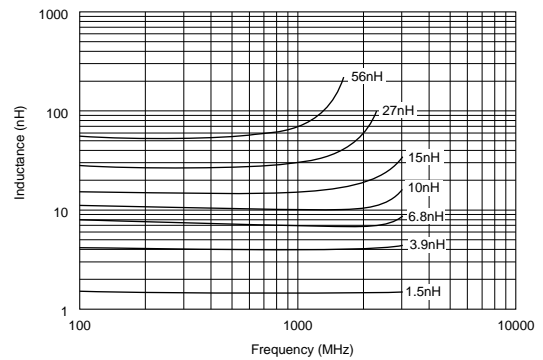

Continued on the following page.

 Continued from the preceding page.

■ Reference Data

E4991A & 16197A

Part Number	Inductance (nH) (typ.)					Q (Typ.)				
	800MHz	900MHz	1.8GHz	2.0GHz	2.4GHz	800MHz	900MHz	1.8GHz	2.0GHz	2.4GHz
LQP03TN0N6	0.6	0.6	0.6	0.6	0.6	50 min.	54 min.	70 min.	73 min.	77 min.
LQP03TN0N7	0.7	0.7	0.7	0.7	0.7	50 min.	54 min.	70 min.	73 min.	77 min.
LQP03TN0N8	0.8	0.8	0.8	0.8	0.8	50 min.	54 min.	70 min.	73 min.	77 min.
LQP03TN0N9	0.9	0.9	0.9	0.9	0.9	50 min.	54 min.	70 min.	73 min.	77 min.
LQP03TN1N0	1.0	1.0	1.0	1.0	1.0	50 min.	54 min.	70 min.	73 min.	77 min.
LQP03TN1N1	1.1	1.1	1.1	1.1	1.1	50 min.	54 min.	70 min.	73 min.	77 min.
LQP03TN1N2	1.2	1.2	1.2	1.2	1.2	50	54	70	73	77
LQP03TN1N3	1.3	1.3	1.3	1.3	1.3	48	52	67	72	74
LQP03TN1N5	1.5	1.5	1.5	1.5	1.5	45	48	63	66	69
LQP03TN1N6	1.6	1.6	1.6	1.6	1.6	43	47	57	64	67
LQP03TN1N8	1.8	1.8	1.8	1.8	1.8	36	38	50	53	55
LQP03TN2N0	2.0	2.0	2.0	2.0	2.0	38	40	52	54	57
LQP03TN2N2	2.2	2.2	2.2	2.2	2.2	28	35	49	52	54
LQP03TN2N4	2.4	2.4	2.4	2.4	2.4	36	38	50	53	56
LQP03TN2N7	2.7	2.7	2.7	2.7	2.7	28	30	40	42	44
LQP03TN3N0	3.0	3.0	3.0	3.0	3.0	28	29	39	41	43
LQP03TN3N3	3.3	3.3	3.3	3.3	3.4	29	31	42	43	45
LQP03TN3N6	3.6	3.6	3.6	3.7	3.7	31	33	43	45	47
LQP03TN3N9	3.9	3.9	3.9	4.0	4.1	29	31	41	43	45
LQP03TN4N3	4.3	4.3	4.3	4.4	4.5	28	30	40	42	44
LQP03TN4N7	4.7	4.7	4.8	4.9	5.1	28	30	40	42	43
LQP03TN5N1	5.1	5.1	5.2	5.3	5.5	26	28	37	39	40
LQP03TN5N6	5.6	5.6	5.8	5.9	6.1	22	24	32	33	33
LQP03TN6N2	6.2	6.2	6.5	6.6	6.9	20	21	27	28	28
LQP03TN6N8	6.8	6.8	7.1	7.4	7.7	21	22	29	30	30
LQP03TN7N5	7.5	7.5	7.9	8.2	8.7	21	22	28	30	29
LQP03TN8N2	8.2	8.2	8.6	9.1	9.6	18	19	25	25	24
LQP03TN9N1	9.1	9.1	9.9	10	11	20	21	26	26	25
LQP03TN10N	10	10	11	12	13	21	22	28	28	27
LQP03TN12N	12	12	13	14	16	21	22	27	27	25
LQP03TN15N	15	15	18	19	23	21	21	25	24	22
LQP03TN18N	18	18	24	-	-	18	19	20	-	-
LQP03TN22N	22	23	32	-	-	16	17	16	-	-
LQP03TN27N	28	29	47	-	-	15	15	13	-	-
LQP03TN33N	35	36	-	-	-	18	19	-	-	-
LQP03TN39N	42	44	-	-	-	15	15	-	-	-
LQP03TN47N	55	58	-	-	-	14	14	-	-	-
LQP03TN56N	63	67	-	-	-	13	13	-	-	-

LQP03T_02 Series

2

LQP03T_02 type has inductance value of 68 to 120nH. This improvement enables easy impedance matching at both RF and IF circuits, and compact high frequency designing.

Also, its highest class Q characteristic compared to other 0201 size inductors, resulting from Murata's miniature manufacturing technology, enables higher performance and smaller packaging of equipment.

■ Features

1. Ultra small and thin size 0.6x0.3x0.3mm (EIA: 0201)
2. High Q value in high frequency range
3. Inductance value 68 to 120nH
4. Inductance tolerance +-5%
5. Sn Electrode

■ Applications

1. High frequency circuits of mobile phones such as PA, ANT, VCO, etc.
2. Mobile phones such as GSM, CDMA, PDC, etc.
3. "Bluetooth"
4. W-LAN
5. High frequency circuits in general

■ Dimensions

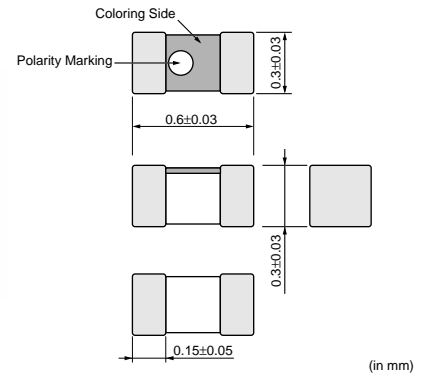

■ Rated Value (□: packaging code)

Part Number	Inductance	Test Frequency	Rated Current	Max. of DC Resistance	Q (min.)	Test Frequency	Self Resonance Frequency (min.)
LQP03TN68NJ02□	68nH±5%	300MHz	50mA	8.00ohm	8	300MHz	1100MHz
LQP03TN82NJ02□	82nH±5%	300MHz	50mA	10.0ohm	8	300MHz	1000MHz
LQP03TNR10J02□	100nH±5%	300MHz	40mA	10.0ohm	8	300MHz	900MHz
LQP03TNR12J02□	120nH±5%	300MHz	40mA	12.0ohm	8	300MHz	800MHz

Operating Temperature Range: -40°C to +85°C Only for reflow soldering.

■ Q - Frequency Characteristics (Typ.)

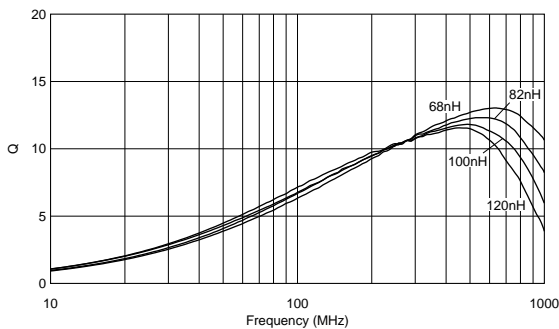

■ Inductance - Frequency Characteristics (Typ.)

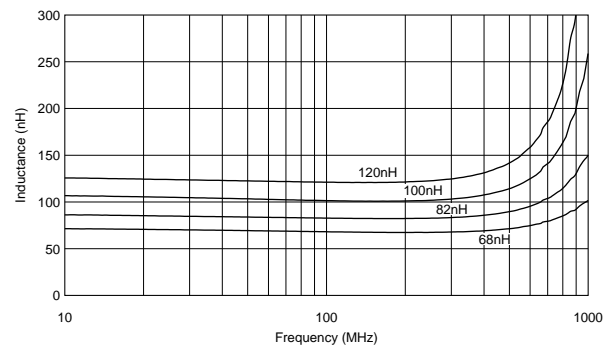

Chip Coils for High Frequency Film Type



LQP03T_04 Series (0201 Size)

LQP03T_04 series offers ultra small size using Murata's miniature manufacturing technology.

By this, LQP03T_04 series contributes to miniaturization of equipment.

Also, its highest class Q characteristic compared to other Monolithic inductors, enables higher performance of equipment.

Furthermore, it enables easy impedance matching at both RF and IF circuits, and compact high frequency circuit designing because it realizes 0.1nH step at 0.6 to 3.9nH and E24 step at 4.3 to 10nH.

■ Dimensions

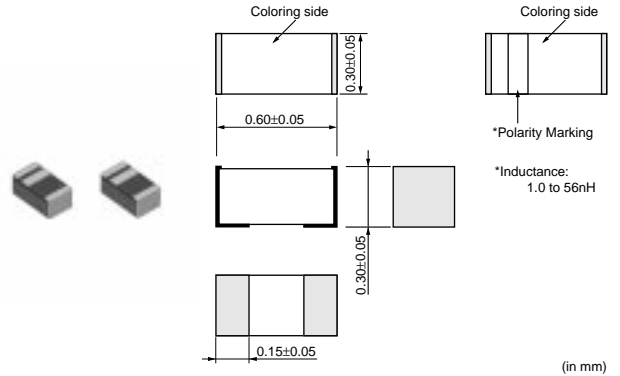

■ Features

1. Ultra small size 0.6x0.3x0.3mm
2. High Q value in high frequency range
3. 0.1nH step
 - 0.6 to 3.9nH: $\pm 0.1\text{nH}$, $\pm 0.2\text{nH}$
 - E24 step
 - 4.3 to 10nH: $\pm 3\%$
 - E12 step
 - 4.7 to 27nH: $\pm 3\%$, $\pm 5\%$
 - 33 to 56nH: $\pm 5\%$
4. Au Electrode

■ Applications

1. High frequency circuits of mobile phones such as PA, ANT, VCO, SAW, etc.
2. Mobile phone
3. "Bluetooth"
4. W-LAN
5. High frequency circuits in general

■ Rated Value (□: packaging code)

Part Number	Inductance	Test Frequency	Rated Current	Max. of DC Resistance	Q (min.)	Test Frequency	Self Resonance Frequency (min.)
LQP03TN0N6B04□	0.6nH \pm 0.1nH	500MHz	420mA	0.08ohm	13	500MHz	6000MHz
LQP03TN0N6C04□	0.6nH \pm 0.2nH	500MHz	420mA	0.08ohm	13	500MHz	6000MHz
LQP03TN0N7B04□	0.7nH \pm 0.1nH	500MHz	410mA	0.09ohm	13	500MHz	6000MHz
LQP03TN0N8B04□	0.8nH \pm 0.1nH	500MHz	410mA	0.09ohm	13	500MHz	6000MHz
LQP03TN0N8C04□	0.8nH \pm 0.2nH	500MHz	410mA	0.09ohm	13	500MHz	6000MHz
LQP03TN0N9B04□	0.9nH \pm 0.1nH	500MHz	400mA	0.10ohm	13	500MHz	6000MHz
LQP03TN1N0B04□	1.0nH \pm 0.1nH	500MHz	400mA	0.10ohm	13	500MHz	6000MHz
LQP03TN1N0C04□	1.0nH \pm 0.2nH	500MHz	400mA	0.10ohm	13	500MHz	6000MHz
LQP03TN1N1B04□	1.1nH \pm 0.1nH	500MHz	280mA	0.13ohm	13	500MHz	6000MHz
LQP03TN1N2B04□	1.2nH \pm 0.1nH	500MHz	280mA	0.13ohm	13	500MHz	6000MHz
LQP03TN1N2C04□	1.2nH \pm 0.2nH	500MHz	280mA	0.13ohm	13	500MHz	6000MHz
LQP03TN1N3B04□	1.3nH \pm 0.1nH	500MHz	280mA	0.16ohm	13	500MHz	6000MHz
LQP03TN1N4B04□	1.4nH \pm 0.1nH	500MHz	280mA	0.16ohm	13	500MHz	6000MHz
LQP03TN1N5B04□	1.5nH \pm 0.1nH	500MHz	280mA	0.16ohm	13	500MHz	6000MHz

Operating Temperature Range: -40°C to +85°C Only for reflow soldering.

Continued on the following page.

Continued from the preceding page.

Part Number	Inductance	Test Frequency	Rated Current	Max. of DC Resistance	Q (min.)	Test Frequency	Self Resonance Frequency (min.)
LQP03TN1N5C04□	1.5nH±0.2nH	500MHz	280mA	0.16ohm	13	500MHz	6000MHz
LQP03TN1N6B04□	1.6nH±0.1nH	500MHz	280mA	0.16ohm	13	500MHz	6000MHz
LQP03TN1N7B04□	1.7nH±0.1nH	500MHz	280mA	0.16ohm	13	500MHz	6000MHz
LQP03TN1N8B04□	1.8nH±0.1nH	500MHz	280mA	0.16ohm	13	500MHz	6000MHz
LQP03TN1N8C04□	1.8nH±0.2nH	500MHz	280mA	0.16ohm	13	500MHz	6000MHz
LQP03TN1N9B04□	1.9nH±0.1nH	500MHz	220mA	0.18ohm	13	500MHz	6000MHz
LQP03TN2N0B04□	2.0nH±0.1nH	500MHz	220mA	0.18ohm	13	500MHz	6000MHz
LQP03TN2N1B04□	2.1nH±0.1nH	500MHz	220mA	0.18ohm	13	500MHz	6000MHz
LQP03TN2N2B04□	2.2nH±0.1nH	500MHz	220mA	0.18ohm	13	500MHz	6000MHz
LQP03TN2N2C04□	2.2nH±0.2nH	500MHz	220mA	0.18ohm	13	500MHz	6000MHz
LQP03TN2N3B04□	2.3nH±0.1nH	500MHz	220mA	0.20ohm	13	500MHz	6000MHz
LQP03TN2N4B04□	2.4nH±0.1nH	500MHz	220mA	0.20ohm	13	500MHz	6000MHz
LQP03TN2N5B04□	2.5nH±0.1nH	500MHz	220mA	0.20ohm	13	500MHz	6000MHz
LQP03TN2N6B04□	2.6nH±0.1nH	500MHz	220mA	0.20ohm	13	500MHz	6000MHz
LQP03TN2N7B04□	2.7nH±0.1nH	500MHz	220mA	0.20ohm	13	500MHz	6000MHz
LQP03TN2N7C04□	2.7nH±0.2nH	500MHz	220mA	0.20ohm	13	500MHz	6000MHz
LQP03TN2N8B04□	2.8nH±0.1nH	500MHz	220mA	0.20ohm	13	500MHz	6000MHz
LQP03TN2N9B04□	2.9nH±0.1nH	500MHz	220mA	0.20ohm	13	500MHz	6000MHz
LQP03TN3N0B04□	3.0nH±0.1nH	500MHz	190mA	0.20ohm	13	500MHz	6000MHz
LQP03TN3N1B04□	3.1nH±0.1nH	500MHz	190mA	0.20ohm	13	500MHz	6000MHz
LQP03TN3N2B04□	3.2nH±0.1nH	500MHz	190mA	0.20ohm	13	500MHz	6000MHz
LQP03TN3N3B04□	3.3nH±0.1nH	500MHz	190mA	0.20ohm	13	500MHz	6000MHz
LQP03TN3N3C04□	3.3nH±0.2nH	500MHz	190mA	0.20ohm	13	500MHz	6000MHz
LQP03TN3N4B04□	3.4nH±0.1nH	500MHz	190mA	0.30ohm	13	500MHz	6000MHz
LQP03TN3N5B04□	3.5nH±0.1nH	500MHz	190mA	0.30ohm	13	500MHz	6000MHz
LQP03TN3N6B04□	3.6nH±0.1nH	500MHz	170mA	0.30ohm	13	500MHz	6000MHz
LQP03TN3N7B04□	3.7nH±0.1nH	500MHz	170mA	0.30ohm	13	500MHz	6000MHz
LQP03TN3N8B04□	3.8nH±0.1nH	500MHz	170mA	0.30ohm	13	500MHz	6000MHz
LQP03TN3N9B04□	3.9nH±0.1nH	500MHz	170mA	0.30ohm	13	500MHz	6000MHz
LQP03TN3N9C04□	3.9nH±0.2nH	500MHz	170mA	0.30ohm	13	500MHz	6000MHz
LQP03TN4N3H04□	4.3nH±3%	500MHz	160mA	0.40ohm	13	500MHz	6000MHz
LQP03TN4N7H04□	4.7nH±3%	500MHz	160mA	0.40ohm	13	500MHz	6000MHz
LQP03TN4N7J04□	4.7nH±5%	500MHz	160mA	0.40ohm	13	500MHz	6000MHz
LQP03TN5N1H04□	5.1nH±3%	500MHz	140mA	0.55ohm	13	500MHz	6000MHz
LQP03TN5N6H04□	5.6nH±3%	500MHz	140mA	0.55ohm	13	500MHz	6000MHz
LQP03TN5N6J04□	5.6nH±5%	500MHz	140mA	0.55ohm	13	500MHz	6000MHz
LQP03TN6N2H04□	6.2nH±3%	500MHz	130mA	0.60ohm	13	500MHz	6000MHz
LQP03TN6N2J04□	6.2nH±5%	500MHz	130mA	0.60ohm	13	500MHz	6000MHz
LQP03TN6N8H04□	6.8nH±3%	500MHz	130mA	0.60ohm	13	500MHz	6000MHz
LQP03TN6N8J04□	6.8nH±5%	500MHz	130mA	0.60ohm	13	500MHz	6000MHz
LQP03TN7N5H04□	7.5nH±3%	500MHz	110mA	0.65ohm	13	500MHz	5500MHz
LQP03TN7N5J04□	7.5nH±5%	500MHz	110mA	0.65ohm	13	500MHz	5500MHz
LQP03TN8N2H04□	8.2nH±3%	500MHz	110mA	0.86ohm	13	500MHz	5500MHz
LQP03TN8N2J04□	8.2nH±5%	500MHz	110mA	0.86ohm	13	500MHz	5500MHz
LQP03TN9N1H04□	9.1nH±3%	500MHz	100mA	1.10ohm	13	500MHz	4500MHz
LQP03TN9N1J04□	9.1nH±5%	500MHz	100mA	1.10ohm	13	500MHz	4500MHz
LQP03TN10NH04□	10nH±3%	500MHz	100mA	1.10ohm	13	500MHz	4500MHz
LQP03TN10NJ04□	10nH±5%	500MHz	100mA	1.10ohm	13	500MHz	4500MHz
LQP03TN12NH04□	12nH±3%	500MHz	90mA	1.15ohm	11	500MHz	3700MHz
LQP03TN12NJ04□	12nH±5%	500MHz	90mA	1.15ohm	11	500MHz	3700MHz
LQP03TN15NH04□	15nH±3%	500MHz	90mA	1.40ohm	11	500MHz	3700MHz

Operating Temperature Range: -40°C to +85°C Only for reflow soldering.

Continued on the following page. 

Continued from the preceding page.

Part Number	Inductance	Test Frequency	Rated Current	Max. of DC Resistance	Q (min.)	Test Frequency	Self Resonance Frequency (min.)
LQP03TN15NJ04□	15nH±5%	500MHz	90mA	1.40ohm	11	500MHz	3700MHz
LQP03TN18NH04□	18nH±3%	500MHz	80mA	1.60ohm	11	500MHz	3100MHz
LQP03TN18NJ04□	18nH±5%	500MHz	80mA	1.60ohm	11	500MHz	3100MHz
LQP03TN22NH04□	22nH±3%	500MHz	70mA	2.55ohm	11	500MHz	2800MHz
LQP03TN22NJ04□	22nH±5%	500MHz	70mA	2.55ohm	11	500MHz	2800MHz
LQP03TN27NH04□	27nH±3%	500MHz	70mA	2.90ohm	11	500MHz	2500MHz
LQP03TN27NJ04□	27nH±5%	500MHz	70mA	2.90ohm	11	500MHz	2500MHz
LQP03TN33NJ04□	33nH±5%	300MHz	60mA	2.95ohm	8	300MHz	2000MHz
LQP03TN39NJ04□	39nH±5%	300MHz	60mA	3.35ohm	8	300MHz	1800MHz
LQP03TN47NJ04□	47nH±5%	300MHz	50mA	3.60ohm	8	300MHz	1600MHz
LQP03TN56NJ04□	56nH±5%	300MHz	50mA	4.30ohm	8	300MHz	1400MHz

Operating Temperature Range: -40°C to +85°C Only for reflow soldering.

■ Q - Frequency Characteristics (Typ.)

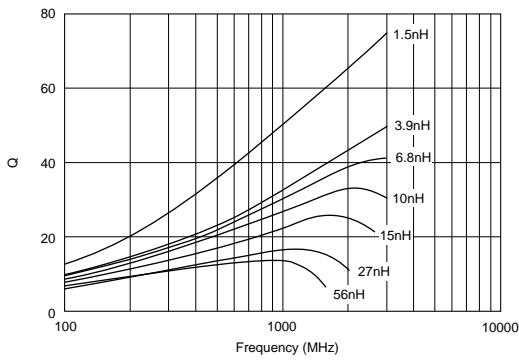

■ Inductance - Frequency Characteristics (Typ.)

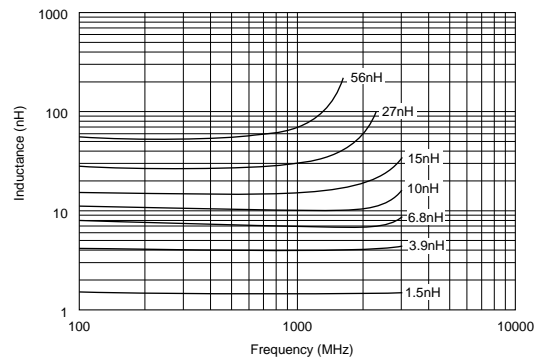

Continued on the following page. ↗

Continued from the preceding page.

Reference Data

E4991A & 16197A

Part Number	Inductance (nH) (Typ.)					Q (Typ.)				
	800MHz	900MHz	1.8GHz	2.0GHz	2.4GHz	800MHz	900MHz	1.8GHz	2.0GHz	2.4GHz
LQP03TN0N6	0.6	0.6	0.6	0.6	0.6	50 min.	54 min.	70 min.	73 min.	77 min.
LQP03TN0N7	0.7	0.7	0.7	0.7	0.7	50 min.	54 min.	70 min.	73 min.	77 min.
LQP03TN0N8	0.8	0.8	0.8	0.8	0.8	50 min.	54 min.	70 min.	73 min.	77 min.
LQP03TN0N9	0.9	0.9	0.9	0.9	0.9	50 min.	54 min.	70 min.	73 min.	77 min.
LQP03TN1N0	1.0	1.0	1.0	1.0	1.0	50 min.	54 min.	70 min.	73 min.	77 min.
LQP03TN1N1	1.1	1.1	1.1	1.1	1.1	50 min.	54 min.	70 min.	73 min.	77 min.
LQP03TN1N2	1.2	1.2	1.2	1.2	1.2	50	54	70	73	77
LQP03TN1N3	1.3	1.3	1.3	1.3	1.3	48	52	67	72	74
LQP03TN1N5	1.5	1.5	1.5	1.5	1.5	45	48	63	66	69
LQP03TN1N6	1.6	1.6	1.6	1.6	1.6	43	47	57	64	67
LQP03TN1N8	1.8	1.8	1.8	1.8	1.8	36	38	50	53	55
LQP03TN2N0	2.0	2.0	2.0	2.0	2.0	38	40	52	54	57
LQP03TN2N2	2.2	2.2	2.2	2.2	2.2	28	35	49	52	54
LQP03TN2N4	2.4	2.4	2.4	2.4	2.4	36	38	50	53	56
LQP03TN2N7	2.7	2.7	2.7	2.7	2.7	28	30	40	42	44
LQP03TN3N0	3.0	3.0	3.0	3.0	3.0	28	29	39	41	43
LQP03TN3N3	3.3	3.3	3.3	3.3	3.4	29	31	42	43	45
LQP03TN3N6	3.6	3.6	3.6	3.7	3.7	31	33	43	45	47
LQP03TN3N9	3.9	3.9	3.9	4.0	4.1	29	31	41	43	45
LQP03TN4N3	4.3	4.3	4.3	4.4	4.5	28	30	40	42	44
LQP03TN4N7	4.7	4.7	4.8	4.9	5.1	28	30	40	42	43
LQP03TN5N1	5.1	5.1	5.2	5.3	5.5	26	28	37	39	40
LQP03TN5N6	5.6	5.6	5.8	5.9	6.1	26	28	36	38	39
LQP03TN6N8	6.8	6.8	7.1	7.4	7.7	26	28	36	38	39
LQP03TN8N2	8.2	8.2	8.6	9.1	9.6	26	28	36	37	38
LQP03TN10N	10	10	11	12	13	24	25	32	32	32
LQP03TN12N	12	12	13	14	16	21	22	27	27	25
LQP03TN15N	15	15	18	19	23	21	21	25	24	22
LQP03TN18N	18	18	24	-	-	18	19	20	-	-
LQP03TN22N	22	23	32	-	-	16	17	16	-	-
LQP03TN27N	28	29	47	-	-	15	15	13	-	-
LQP03TN33N	35	36	-	-	-	18	19	-	-	-
LQP03TN39N	42	44	-	-	-	15	15	-	-	-
LQP03TN47N	55	58	-	-	-	14	14	-	-	-
LQP03TN56N	63	67	-	-	-	13	13	-	-	-

Chip Coils for High Frequency Film Type



LQP15T Series (0402 Size)

2

LQP15T series offers High Q value, tight inductance tolerance within a small/thin package using Murata's original film engineering technology.

■ Dimensions

■ Features

1. High Q value
2. Tight inductance tolerance (+-0.1nH, +-0.2nH, +-3%)
3. Ultra small and thin size (0402 size, height 0.4mm)
4. Low DC resistance

■ Applications

1. High frequency circuits of mobile phones such as PA, ANT, VCO, SAW, etc.
2. Mobile phones
3. "Bluetooth"
4. W-LAN
5. High frequency circuits in general

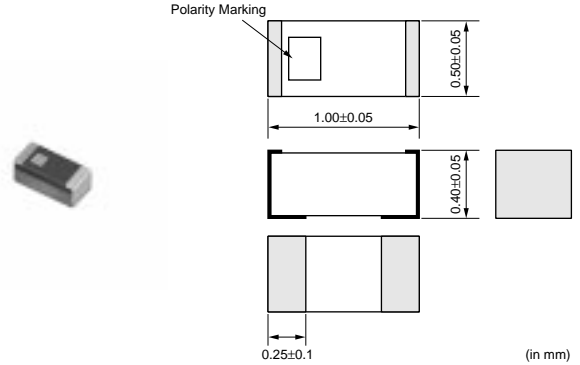

■ Rated Value (□: packaging code)

Part Number	Inductance	Test Frequency	Rated Current	Max. of DC Resistance	Q (min.)	Test Frequency	Self Resonance Frequency (min.)
LQP15TN1N0B02□	1.0nH±0.1nH	500MHz	300mA	0.1ohm	17	500MHz	6000MHz
LQP15TN1N0C02□	1.0nH±0.2nH	500MHz	300mA	0.1ohm	17	500MHz	6000MHz
LQP15TN1N1B02□	1.1nH±0.1nH	500MHz	300mA	0.1ohm	17	500MHz	6000MHz
LQP15TN1N1C02□	1.1nH±0.2nH	500MHz	300mA	0.1ohm	17	500MHz	6000MHz
LQP15TN1N2B02□	1.2nH±0.1nH	500MHz	300mA	0.1ohm	17	500MHz	6000MHz
LQP15TN1N2C02□	1.2nH±0.2nH	500MHz	300mA	0.1ohm	17	500MHz	6000MHz
LQP15TN1N3B02□	1.3nH±0.1nH	500MHz	300mA	0.15ohm	17	500MHz	6000MHz
LQP15TN1N3C02□	1.3nH±0.2nH	500MHz	300mA	0.15ohm	17	500MHz	6000MHz
LQP15TN1N5B02□	1.5nH±0.1nH	500MHz	300mA	0.15ohm	17	500MHz	6000MHz
LQP15TN1N5C02□	1.5nH±0.2nH	500MHz	300mA	0.15ohm	17	500MHz	6000MHz
LQP15TN1N6B02□	1.6nH±0.1nH	500MHz	250mA	0.15ohm	17	500MHz	6000MHz
LQP15TN1N6C02□	1.6nH±0.2nH	500MHz	250mA	0.15ohm	17	500MHz	6000MHz
LQP15TN1N8B02□	1.8nH±0.1nH	500MHz	250mA	0.15ohm	17	500MHz	6000MHz
LQP15TN1N8C02□	1.8nH±0.2nH	500MHz	250mA	0.15ohm	17	500MHz	6000MHz
LQP15TN2N0C02□	2.0nH±0.2nH	500MHz	220mA	0.2ohm	17	500MHz	6000MHz
LQP15TN2N2C02□	2.2nH±0.2nH	500MHz	220mA	0.2ohm	17	500MHz	6000MHz
LQP15TN2N4C02□	2.4nH±0.2nH	500MHz	220mA	0.2ohm	17	500MHz	6000MHz
LQP15TN2N7C02□	2.7nH±0.2nH	500MHz	220mA	0.2ohm	17	500MHz	6000MHz
LQP15TN3N0C02□	3.0nH±0.2nH	500MHz	190mA	0.3ohm	17	500MHz	5500MHz
LQP15TN3N3C02□	3.3nH±0.2nH	500MHz	190mA	0.3ohm	17	500MHz	5500MHz
LQP15TN3N6C02□	3.6nH±0.2nH	500MHz	170mA	0.4ohm	17	500MHz	5500MHz
LQP15TN3N9C02□	3.9nH±0.2nH	500MHz	170mA	0.4ohm	17	500MHz	5500MHz
LQP15TN4N7C02□	4.7nH±0.2nH	500MHz	160mA	0.5ohm	17	500MHz	5000MHz
LQP15TN5N6C02□	5.6nH±0.2nH	500MHz	140mA	0.6ohm	17	500MHz	4500MHz
LQP15TN6N8H02□	6.8nH±3%	500MHz	130mA	0.7ohm	17	500MHz	3500MHz
LQP15TN8N2H02□	8.2nH±3%	500MHz	110mA	0.8ohm	17	500MHz	3000MHz
LQP15TN10NH02□	10nH±3%	500MHz	100mA	1.0ohm	17	500MHz	2500MHz

Operating Temperature Range: -40°C to +85°C Only for reflow soldering.

Continued on the following page. ↗

Continued from the preceding page.

Part Number	Inductance	Test Frequency	Rated Current	Max. of DC Resistance	Q (min.)	Test Frequency	Self Resonance Frequency (min.)
LQP15TN12NH02□	12nH±3%	500MHz	90mA	1.0ohm	17	500MHz	2500MHz
LQP15TN15NH02□	15nH±3%	500MHz	90mA	1.3ohm	17	500MHz	2000MHz
LQP15TN18NH02□	18nH±3%	500MHz	80mA	1.5ohm	17	500MHz	1500MHz

Operating Temperature Range: -40°C to +85°C Only for reflow soldering.

2

■ Q - Frequency Characteristics (Typ.)

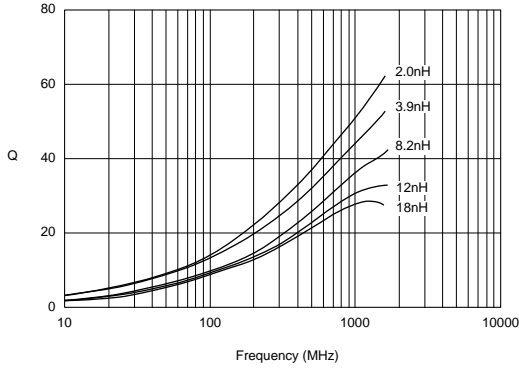

■ Inductance - Frequency Characteristics (Typ.)

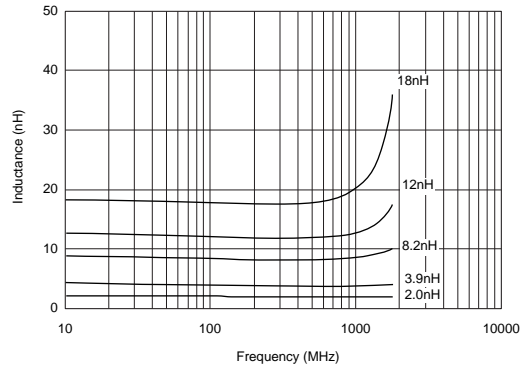

Chip Coils for High Frequency Film Type



LQP15M Series (0402 Size)

■ Features

1. Tight inductance tolerance (+/-0.05nH, +/-0.1nH, +/-2%) realized by Murata's original film technology. Various inductance values enable assembly with no tuning.
2. Ultra small size 0402 inductor which is low profile and lightest weight in the world enables miniaturizing of mobile telecommunications equipment. LQP15M series weighs 0.6mg/pc. while multilayer type inductor weighs 0.9mg/pc.
3. High Q at high frequency range.
4. High self-resonant frequency due to low stray capacitance and narrow inductance distribution provides stable inductance in high frequency circuits such as telecommunications equipment.

■ Dimensions

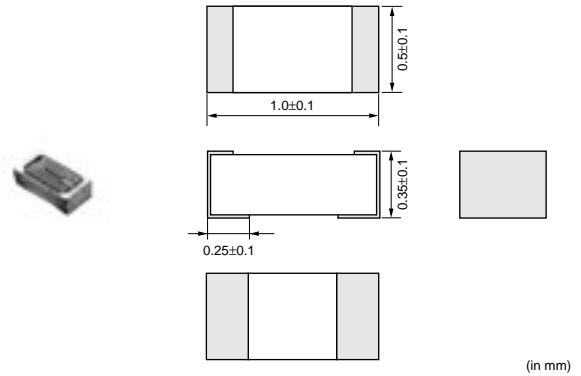

■ Applications

1. High frequency circuits of mobile phones such as PA, ANT, VCO, SAW, etc.
2. Mobile phones
3. "Bluetooth"
4. W-LAN
5. High frequency circuits in general

■ Rated Value (□: packaging code)

Part Number	Inductance	Test Frequency	Rated Current	Max. of DC Resistance	Q (min.)	Test Frequency	Self Resonance Frequency (min.)
LQP15MN1N0B02□	1.0nH±0.1nH	500MHz	400mA	0.1ohm	13	500MHz	6000MHz
LQP15MN1N0W02□	1.0nH±0.05nH	500MHz	400mA	0.1ohm	13	500MHz	6000MHz
LQP15MN1N1B02□	1.1nH±0.1nH	500MHz	390mA	0.1ohm	13	500MHz	6000MHz
LQP15MN1N1W02□	1.1nH±0.05nH	500MHz	390mA	0.1ohm	13	500MHz	6000MHz
LQP15MN1N2B02□	1.2nH±0.1nH	500MHz	390mA	0.1ohm	13	500MHz	6000MHz
LQP15MN1N2W02□	1.2nH±0.05nH	500MHz	390mA	0.1ohm	13	500MHz	6000MHz
LQP15MN1N3B02□	1.3nH±0.1nH	500MHz	280mA	0.2ohm	13	500MHz	6000MHz
LQP15MN1N3W02□	1.3nH±0.05nH	500MHz	280mA	0.2ohm	13	500MHz	6000MHz
LQP15MN1N4W02□	1.4nH±0.05nH	500MHz	280mA	0.2ohm	13	500MHz	6000MHz
LQP15MN1N5B02□	1.5nH±0.1nH	500MHz	280mA	0.2ohm	13	500MHz	6000MHz
LQP15MN1N5W02□	1.5nH±0.05nH	500MHz	280mA	0.2ohm	13	500MHz	6000MHz
LQP15MN1N6B02□	1.6nH±0.1nH	500MHz	220mA	0.3ohm	13	500MHz	6000MHz
LQP15MN1N6W02□	1.6nH±0.05nH	500MHz	220mA	0.3ohm	13	500MHz	6000MHz
LQP15MN1N7W02□	1.7nH±0.05nH	500MHz	280mA	0.2ohm	13	500MHz	6000MHz
LQP15MN1N8B02□	1.8nH±0.1nH	500MHz	280mA	0.2ohm	13	500MHz	6000MHz
LQP15MN1N8W02□	1.8nH±0.05nH	500MHz	280mA	0.2ohm	13	500MHz	6000MHz
LQP15MN1N9W02□	1.9nH±0.05nH	500MHz	220mA	0.3ohm	13	500MHz	6000MHz
LQP15MN2N0B02□	2.0nH±0.1nH	500MHz	220mA	0.3ohm	13	500MHz	6000MHz
LQP15MN2N0W02□	2.0nH±0.05nH	500MHz	220mA	0.3ohm	13	500MHz	6000MHz
LQP15MN2N1W02□	2.1nH±0.05nH	500MHz	220mA	0.3ohm	13	500MHz	6000MHz
LQP15MN2N2B02□	2.2nH±0.1nH	500MHz	220mA	0.3ohm	13	500MHz	6000MHz
LQP15MN2N2W02□	2.2nH±0.05nH	500MHz	220mA	0.3ohm	13	500MHz	6000MHz

Operating Temperature Range: -40°C to +85°C Only for reflow soldering.

Continued on the following page.

Continued from the preceding page.

2

Part Number	Inductance	Test Frequency	Rated Current	Max. of DC Resistance	Q (min.)	Test Frequency	Self Resonance Frequency (min.)
LQP15MN2N3W02□	2.3nH±0.05nH	500MHz	220mA	0.3ohm	13	500MHz	6000MHz
LQP15MN2N4B02□	2.4nH±0.1nH	500MHz	220mA	0.3ohm	13	500MHz	6000MHz
LQP15MN2N4W02□	2.4nH±0.05nH	500MHz	220mA	0.3ohm	13	500MHz	6000MHz
LQP15MN2N5W02□	2.5nH±0.05nH	500MHz	220mA	0.3ohm	13	500MHz	6000MHz
LQP15MN2N6W02□	2.6nH±0.05nH	500MHz	220mA	0.3ohm	13	500MHz	6000MHz
LQP15MN2N7B02□	2.7nH±0.1nH	500MHz	220mA	0.3ohm	13	500MHz	6000MHz
LQP15MN2N7W02□	2.7nH±0.05nH	500MHz	220mA	0.3ohm	13	500MHz	6000MHz
LQP15MN2N8W02□	2.8nH±0.05nH	500MHz	190mA	0.4ohm	13	500MHz	6000MHz
LQP15MN2N9W02□	2.9nH±0.05nH	500MHz	190mA	0.4ohm	13	500MHz	6000MHz
LQP15MN3N0B02□	3.0nH±0.1nH	500MHz	190mA	0.4ohm	13	500MHz	6000MHz
LQP15MN3N0W02□	3.0nH±0.05nH	500MHz	190mA	0.4ohm	13	500MHz	6000MHz
LQP15MN3N1W02□	3.1nH±0.05nH	500MHz	190mA	0.4ohm	13	500MHz	6000MHz
LQP15MN3N2W02□	3.2nH±0.05nH	500MHz	190mA	0.4ohm	13	500MHz	6000MHz
LQP15MN3N3B02□	3.3nH±0.1nH	500MHz	190mA	0.4ohm	13	500MHz	6000MHz
LQP15MN3N3W02□	3.3nH±0.05nH	500MHz	190mA	0.4ohm	13	500MHz	6000MHz
LQP15MN3N4W02□	3.4nH±0.05nH	500MHz	170mA	0.5ohm	13	500MHz	6000MHz
LQP15MN3N5W02□	3.5nH±0.05nH	500MHz	170mA	0.5ohm	13	500MHz	6000MHz
LQP15MN3N6B02□	3.6nH±0.1nH	500MHz	170mA	0.5ohm	13	500MHz	6000MHz
LQP15MN3N6W02□	3.6nH±0.05nH	500MHz	170mA	0.5ohm	13	500MHz	6000MHz
LQP15MN3N7W02□	3.7nH±0.05nH	500MHz	170mA	0.5ohm	13	500MHz	6000MHz
LQP15MN3N8W02□	3.8nH±0.05nH	500MHz	170mA	0.5ohm	13	500MHz	6000MHz
LQP15MN3N9B02□	3.9nH±0.1nH	500MHz	170mA	0.5ohm	13	500MHz	6000MHz
LQP15MN3N9W02□	3.9nH±0.05nH	500MHz	170mA	0.5ohm	13	500MHz	6000MHz
LQP15MN4N3B02□	4.3nH±0.1nH	500MHz	160mA	0.6ohm	13	500MHz	6000MHz
LQP15MN4N7B02□	4.7nH±0.1nH	500MHz	160mA	0.6ohm	13	500MHz	6000MHz
LQP15MN5N1B02□	5.1nH±0.1nH	500MHz	140mA	0.7ohm	13	500MHz	6000MHz
LQP15MN5N6B02□	5.6nH±0.1nH	500MHz	140mA	0.7ohm	13	500MHz	6000MHz
LQP15MN6N2B02□	6.2nH±0.1nH	500MHz	130mA	0.9ohm	13	500MHz	6000MHz
LQP15MN6N8B02□	6.8nH±0.1nH	500MHz	130mA	0.9ohm	13	500MHz	6000MHz
LQP15MN7N5B02□	7.5nH±0.1nH	500MHz	110mA	1.1ohm	13	500MHz	5500MHz
LQP15MN8N2B02□	8.2nH±0.1nH	500MHz	110mA	1.1ohm	13	500MHz	5500MHz
LQP15MN9N1B02□	9.1nH±0.1nH	500MHz	100mA	1.3ohm	13	500MHz	4500MHz
LQP15MN10NG02□	10nH±2%	500MHz	100mA	1.3ohm	13	500MHz	4500MHz
LQP15MN12NG02□	12nH±2%	500MHz	90mA	1.6ohm	13	500MHz	3700MHz
LQP15MN15NG02□	15nH±2%	500MHz	90mA	1.8ohm	13	500MHz	3300MHz
LQP15MN18NG02□	18nH±2%	500MHz	80mA	2.0ohm	13	500MHz	3100MHz
LQP15MN22NG02□	22nH±2%	500MHz	70mA	2.6ohm	13	500MHz	2800MHz
LQP15MN27NG02□	27nH±2%	500MHz	70mA	3.1ohm	13	500MHz	2500MHz
LQP15MN33NG02□	33nH±2%	500MHz	60mA	3.8ohm	13	500MHz	2100MHz

Operating Temperature Range: -40°C to +85°C Only for reflow soldering.

■ Q - Frequency Characteristics (Typ.)

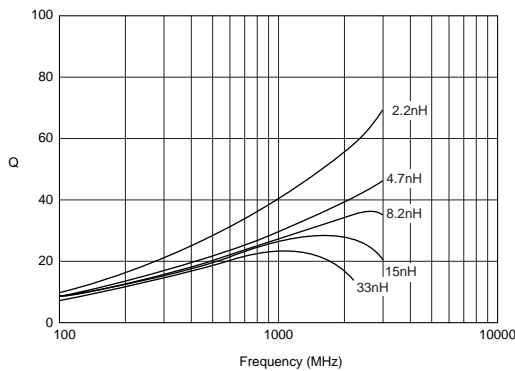

■ Inductance - Frequency Characteristics (Typ.)

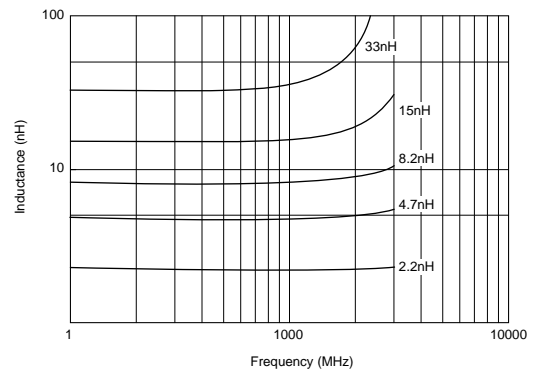

Continued on the following page. ↗

Continued from the preceding page.

Reference Data

E4991A+16197A

Part Number	Inductance (nH) (Typ.)					Q (Typ.)				
	800MHz	900MHz	1.8GHz	2.0GHz	2.4GHz	800MHz	900MHz	1.8GHz	2.0GHz	2.4GHz
LQP15MN1N0	1.0	1.0	1.0	1.0	1.0	50	55	73	76	85
LQP15MN1N1	1.1	1.1	1.1	1.1	1.1	44	47	70	76	83
LQP15MN1N2	1.2	1.2	1.2	1.2	1.2	43	47	69	76	82
LQP15MN1N3	1.3	1.3	1.3	1.3	1.3	39	43	56	60	65
LQP15MN1N4	1.4	1.4	1.4	1.4	1.4	39	41	51	54	58
LQP15MN1N5	1.5	1.5	1.5	1.5	1.5	38	40	49	51	54
LQP15MN1N6	1.6	1.6	1.6	1.6	1.6	26	28	37	39	42
LQP15MN1N7	1.7	1.7	1.7	1.7	1.7	37	40	48	49	53
LQP15MN1N8	1.8	1.8	1.8	1.8	1.8	35	37	46	49	52
LQP15MN1N9	1.9	1.9	1.9	1.9	1.9	34	36	46	49	52
LQP15MN2N0	2.0	2.0	2.0	2.0	2.0	34	36	47	50	53
LQP15MN2N1	2.1	2.1	2.1	2.1	2.1	35	37	47	49	53
LQP15MN2N2	2.2	2.2	2.2	2.2	2.2	36	38	48	51	56
LQP15MN2N3	2.3	2.3	2.3	2.3	2.3	36	38	47	49	53
LQP15MN2N4	2.4	2.4	2.4	2.4	2.4	35	37	47	49	52
LQP15MN2N5	2.5	2.5	2.5	2.5	2.5	35	37	47	49	53
LQP15MN2N6	2.6	2.6	2.6	2.6	2.6	35	37	47	49	52
LQP15MN2N7	2.7	2.7	2.7	2.7	2.7	35	37	48	49	53
LQP15MN2N8	2.8	2.8	2.8	2.8	2.8	35	37	47	49	53
LQP15MN2N9	2.9	2.9	2.9	2.9	2.9	33	35	44	46	49
LQP15MN3N0	3.0	3.0	3.0	3.0	3.0	29	31	41	44	48
LQP15MN3N1	3.1	3.1	3.1	3.1	3.1	28	29	39	42	45
LQP15MN3N2	3.2	3.2	3.2	3.2	3.2	27	28	35	36	38
LQP15MN3N3	3.3	3.3	3.3	3.3	3.4	28	29	38	39	43
LQP15MN3N4	3.4	3.4	3.4	3.4	3.5	28	29	37	39	41
LQP15MN3N5	3.5	3.5	3.5	3.5	3.6	28	29	37	38	40
LQP15MN3N6	3.6	3.6	3.6	3.7	3.7	27	28	35	39	41
LQP15MN3N7	3.7	3.7	3.7	3.8	3.8	27	28	35	38	41
LQP15MN3N8	3.8	3.8	3.8	3.9	3.9	28	29	38	39	42
LQP15MN3N9	3.9	3.9	3.9	4.0	4.0	28	29	37	38	41
LQP15MN4N3	4.3	4.3	4.3	4.4	4.5	28	30	38	40	42
LQP15MN4N7	4.7	4.7	4.8	4.9	5.1	28	29	38	39	41
LQP15MN5N1	5.1	5.1	5.2	5.3	5.5	26	28	36	38	40
LQP15MN5N6	5.6	5.6	5.8	6.0	6.2	23	25	32	33	34
LQP15MN6N2	6.2	6.2	6.5	6.6	6.9	23	25	32	33	34
LQP15MN6N8	6.8	6.8	7.1	7.4	7.7	24	26	33	34	35
LQP15MN7N5	7.5	7.5	7.9	8.2	8.6	24	25	32	33	34
LQP15MN8N2	8.2	8.2	8.7	9.0	9.5	24	25	32	33	34
LQP15MN9N1	9.1	9.1	9.8	10	11	23	25	31	32	33
LQP15MN10N	10	10	11	12	13	24	26	30	31	31
LQP15MN12N	12	12	13	14	16	25	26	29	29	28
LQP15MN15N	15	15	18	19	23	23	25	26	27	25
LQP15MN18N	18	18	23	-	-	22	23	24	-	-
LQP15MN22N	22	23	29	-	-	22	23	22	-	-
LQP15MN27N	28	28	38	-	-	22	23	21	-	-
LQP15MN33N	34	35	-	-	-	21	22	-	-	-

Chip Coils for High Frequency Film Type



LQP18M Series (0603 Size)

2

■ Features

1. Tight inductance tolerance (+-0.2nH, +-2%) realized by Murata's original film technology. Various inductance values enable assembly with no tuning.
2. Small size of LQP18M series is suitable for small handheld equipment, especially for card size equipment.
3. High Q at high frequency range.
4. High self-resonant frequency due to low stray capacitance and narrow inductance distribution provides stable inductance in high frequency circuits such as telecommunications equipment.

■ Dimensions

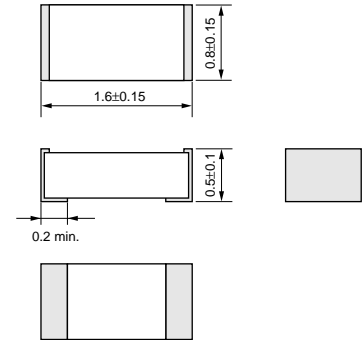

(in mm)

■ Applications

1. High frequency circuits of mobile phones such as PA, ANT, VCO, SAW, etc.
2. Mobile phones
3. "Bluetooth"
4. W-LAN
5. High frequency circuits in general

■ Rated Value (□: packaging code)

Part Number	Inductance	Test Frequency	Rated Current	Max. of DC Resistance	Q (min.)	Test Frequency	Self Resonance Frequency (min.)
LQP18MN1N3C02□	1.3nH±0.2nH	500MHz	300mA	0.3ohm	17	500MHz	6000MHz
LQP18MN1N5C02□	1.5nH±0.2nH	500MHz	300mA	0.3ohm	17	500MHz	6000MHz
LQP18MN1N8C02□	1.8nH±0.2nH	500MHz	250mA	0.4ohm	17	500MHz	6000MHz
LQP18MN2N2C02□	2.2nH±0.2nH	500MHz	250mA	0.4ohm	17	500MHz	6000MHz
LQP18MN2N7C02□	2.7nH±0.2nH	500MHz	250mA	0.4ohm	17	500MHz	6000MHz
LQP18MN3N3C02□	3.3nH±0.2nH	500MHz	250mA	0.4ohm	17	500MHz	6000MHz
LQP18MN3N9C02□	3.9nH±0.2nH	500MHz	200mA	0.5ohm	17	500MHz	5900MHz
LQP18MN4N7C02□	4.7nH±0.2nH	500MHz	200mA	0.5ohm	17	500MHz	5200MHz
LQP18MN5N6C02□	5.6nH±0.2nH	500MHz	200mA	0.6ohm	17	500MHz	4700MHz
LQP18MN6N8C02□	6.8nH±0.2nH	500MHz	200mA	0.7ohm	17	500MHz	4300MHz
LQP18MN8N2C02□	8.2nH±0.2nH	500MHz	150mA	0.8ohm	17	500MHz	3600MHz
LQP18MN10NG02□	10nH±2%	500MHz	150mA	1.0ohm	17	500MHz	3400MHz
LQP18MN12NG02□	12nH±2%	500MHz	150mA	1.0ohm	17	500MHz	3000MHz
LQP18MN15NG02□	15nH±2%	500MHz	150mA	1.3ohm	17	500MHz	2700MHz
LQP18MN18NG02□	18nH±2%	500MHz	100mA	1.5ohm	17	500MHz	2300MHz
LQP18MN22NG02□	22nH±2%	500MHz	100mA	1.9ohm	17	500MHz	2100MHz
LQP18MN27NG02□	27nH±2%	500MHz	100mA	2.4ohm	17	500MHz	1900MHz
LQP18MN33NG02□	33nH±2%	500MHz	100mA	2.8ohm	17	500MHz	1700MHz
LQP18MN39NG02□	39nH±2%	500MHz	100mA	2.8ohm	17	500MHz	1400MHz
LQP18MN47NG02□	47nH±2%	300MHz	100mA	2.2ohm	17	300MHz	1200MHz
LQP18MN56NG02□	56nH±2%	300MHz	50mA	3.4ohm	17	300MHz	1000MHz
LQP18MN68NG02□	68nH±2%	300MHz	50mA	3.5ohm	17	300MHz	900MHz
LQP18MN82NG02□	82nH±2%	300MHz	50mA	4.6ohm	17	300MHz	800MHz
LQP18MNR10G02□	100nH±2%	300MHz	50mA	6.1ohm	17	300MHz	700MHz

Operating Temperature Range: -40°C to +85°C Only for reflow soldering.

Continued on the following page.

Continued from the preceding page.

■ Q - Frequency Characteristics (Typ.)

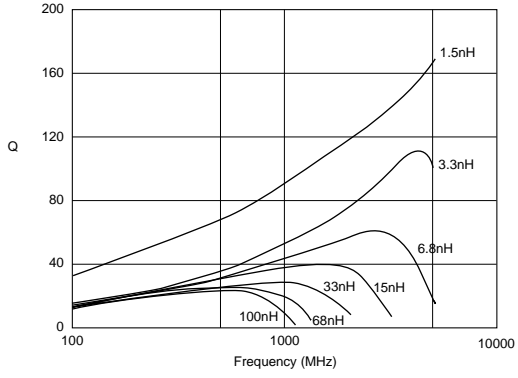

■ Inductance - Frequency Characteristics (Typ.)

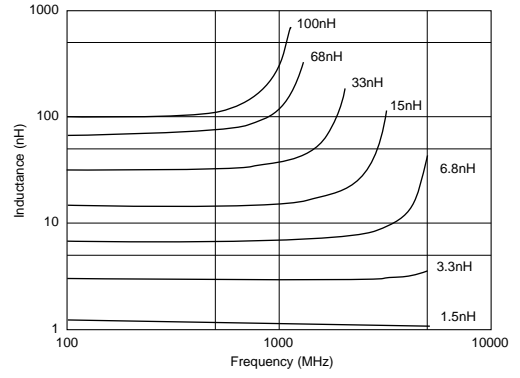

2

Chip Coils for High Frequency Horizontal Wire Wound



LQW04A Series (03015 Size)

3

LQW04A series consists of air core chip coil using a miniature alumina core.

LQW04A series has high Q value in high frequency range and high self-resonant frequency. It is suitable for high frequency circuits which are used in telecommunications equipment.

■ Dimensions

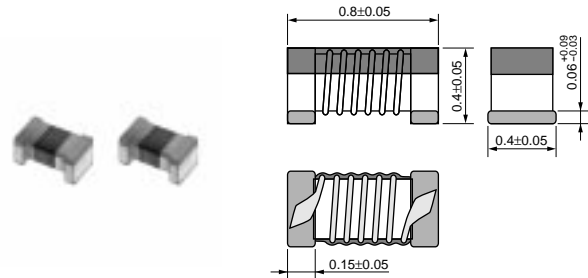

(in mm)

■ Features

1. Horizontal wire wound structure.
2. The subminiature dimensions (0.8x0.4mm) allow high density mounting, and 0.4mm low profile.
3. The high self-resonant frequency realizes high Q value and stable inductance at high frequency.
4. Low DC resistance design is ideal for low loss, high output and low power consumption.
5. Resin-coated surface enables excellent mounting.

■ Applications

1. High frequency module of mobile phones such as PA, ANT, VCO, SAW, etc.
2. Mobile phones
3. Digital TV tuner
4. W-LAN
5. "Bluetooth"
6. High frequency circuits in general

■ Rated Value (□: packaging code)

Part Number	Inductance	Test Frequency	Rated Current	Max. of DC Resistance	Q (min.)	Test Frequency	Self Resonance Frequency (min.)
LQW04AN1N1C00□	1.1nH±0.2nH	100MHz	990mA	0.03ohm	15	250MHz	20.0GHz
LQW04AN1N1D00□	1.1nH±0.5nH	100MHz	990mA	0.03ohm	15	250MHz	20.0GHz
LQW04AN1N8C00□	1.8nH±0.2nH	100MHz	700mA	0.06ohm	15	250MHz	17.0GHz
LQW04AN1N8D00□	1.8nH±0.5nH	100MHz	700mA	0.06ohm	15	250MHz	17.0GHz
LQW04AN2N7C00□	2.7nH±0.2nH	100MHz	570mA	0.07ohm	15	250MHz	15.0GHz
LQW04AN2N7D00□	2.7nH±0.5nH	100MHz	570mA	0.07ohm	15	250MHz	15.0GHz
LQW04AN3N0C00□	3.0nH±0.2nH	100MHz	620mA	0.07ohm	15	250MHz	13.0GHz
LQW04AN3N0D00□	3.0nH±0.5nH	100MHz	620mA	0.07ohm	15	250MHz	13.0GHz
LQW04AN3N6C00□	3.6nH±0.2nH	100MHz	530mA	0.10ohm	15	250MHz	13.0GHz
LQW04AN3N6D00□	3.6nH±0.5nH	100MHz	530mA	0.10ohm	15	250MHz	13.0GHz
LQW04AN3N9C00□	3.9nH±0.2nH	100MHz	530mA	0.10ohm	15	250MHz	12.0GHz
LQW04AN3N9D00□	3.9nH±0.5nH	100MHz	530mA	0.10ohm	15	250MHz	12.0GHz
LQW04AN4N3C00□	4.3nH±0.2nH	100MHz	530mA	0.10ohm	15	250MHz	11.0GHz
LQW04AN4N3D00□	4.3nH±0.5nH	100MHz	530mA	0.10ohm	15	250MHz	11.0GHz
LQW04AN4N7C00□	4.7nH±0.2nH	100MHz	440mA	0.14ohm	20	250MHz	10.0GHz
LQW04AN4N7D00□	4.7nH±0.5nH	100MHz	440mA	0.14ohm	20	250MHz	10.0GHz
LQW04AN5N1C00□	5.1nH±0.2nH	100MHz	470mA	0.12ohm	20	250MHz	10.0GHz
LQW04AN5N1D00□	5.1nH±0.5nH	100MHz	470mA	0.12ohm	20	250MHz	10.0GHz
LQW04AN5N6C00□	5.6nH±0.2nH	100MHz	470mA	0.12ohm	20	250MHz	9.0GHz

Operating Temperature Range: -55°C to +125°C Only for reflow soldering.

Continued on the following page.

Continued from the preceding page.

Part Number	Inductance	Test Frequency	Rated Current	Max. of DC Resistance	Q (min.)	Test Frequency	Self Resonance Frequency (min.)
LQW04AN5N6D00□	5.6nH±0.5nH	100MHz	470mA	0.12ohm	20	250MHz	9.0GHz
LQW04AN6N2C00□	6.2nH±0.2nH	100MHz	390mA	0.19ohm	20	250MHz	9.0GHz
LQW04AN6N2D00□	6.2nH±0.5nH	100MHz	390mA	0.19ohm	20	250MHz	9.0GHz
LQW04AN6N8C00□	6.8nH±0.2nH	100MHz	440mA	0.14ohm	20	250MHz	9.0GHz
LQW04AN6N8D00□	6.8nH±0.5nH	100MHz	440mA	0.14ohm	20	250MHz	9.0GHz
LQW04AN7N5C00□	7.5nH±0.2nH	100MHz	440mA	0.14ohm	20	250MHz	8.0GHz
LQW04AN7N5D00□	7.5nH±0.5nH	100MHz	440mA	0.14ohm	20	250MHz	8.0GHz
LQW04AN8N2C00□	8.2nH±0.2nH	100MHz	350mA	0.23ohm	20	250MHz	8.0GHz
LQW04AN8N2D00□	8.2nH±0.5nH	100MHz	350mA	0.23ohm	20	250MHz	8.0GHz
LQW04AN9N1C00□	9.1nH±0.2nH	100MHz	400mA	0.16ohm	20	250MHz	7.0GHz
LQW04AN9N1D00□	9.1nH±0.5nH	100MHz	400mA	0.16ohm	20	250MHz	7.0GHz
LQW04AN10NH00□	10nH±3%	100MHz	330mA	0.26ohm	20	250MHz	7.0GHz
LQW04AN10NJ00□	10nH±5%	100MHz	330mA	0.26ohm	20	250MHz	7.0GHz
LQW04AN11NH00□	11nH±3%	100MHz	310mA	0.28ohm	15	250MHz	7.0GHz
LQW04AN11NJ00□	11nH±5%	100MHz	310mA	0.28ohm	15	250MHz	7.0GHz
LQW04AN12NH00□	12nH±3%	100MHz	310mA	0.28ohm	15	250MHz	6.0GHz
LQW04AN12NJ00□	12nH±5%	100MHz	310mA	0.28ohm	15	250MHz	6.0GHz
LQW04AN13NH00□	13nH±3%	100MHz	280mA	0.34ohm	15	250MHz	6.0GHz
LQW04AN13NJ00□	13nH±5%	100MHz	280mA	0.34ohm	15	250MHz	6.0GHz
LQW04AN15NH00□	15nH±3%	100MHz	240mA	0.48ohm	15	250MHz	5.5GHz
LQW04AN15NJ00□	15nH±5%	100MHz	240mA	0.48ohm	15	250MHz	5.5GHz
LQW04AN16NH00□	16nH±3%	100MHz	270mA	0.38ohm	15	250MHz	5.5GHz
LQW04AN16NJ00□	16nH±5%	100MHz	270mA	0.38ohm	15	250MHz	5.5GHz
LQW04AN18NH00□	18nH±3%	100MHz	220mA	0.54ohm	15	250MHz	5.0GHz
LQW04AN18NJ00□	18nH±5%	100MHz	220mA	0.54ohm	15	250MHz	5.0GHz
LQW04AN19NH00□	19nH±3%	100MHz	210mA	0.56ohm	15	250MHz	5.0GHz
LQW04AN19NJ00□	19nH±5%	100MHz	210mA	0.56ohm	15	250MHz	5.0GHz
LQW04AN20NH00□	20nH±3%	100MHz	210mA	0.56ohm	15	250MHz	5.0GHz
LQW04AN20NJ00□	20nH±5%	100MHz	210mA	0.56ohm	15	250MHz	5.0GHz
LQW04AN22NH00□	22nH±3%	100MHz	200mA	0.63ohm	15	250MHz	5.0GHz
LQW04AN22NJ00□	22nH±5%	100MHz	200mA	0.63ohm	15	250MHz	5.0GHz
LQW04AN23NH00□	23nH±3%	100MHz	160mA	0.95ohm	15	250MHz	4.0GHz
LQW04AN23NJ00□	23nH±5%	100MHz	160mA	0.95ohm	15	250MHz	4.0GHz
LQW04AN24NH00□	24nH±3%	100MHz	160mA	0.95ohm	15	250MHz	4.0GHz
LQW04AN24NJ00□	24nH±5%	100MHz	160mA	0.95ohm	15	250MHz	4.0GHz
LQW04AN25NH00□	25nH±3%	100MHz	160mA	0.95ohm	15	250MHz	4.0GHz
LQW04AN25NJ00□	25nH±5%	100MHz	160mA	0.95ohm	15	250MHz	4.0GHz
LQW04AN27NH00□	27nH±3%	100MHz	160mA	0.95ohm	15	250MHz	4.0GHz
LQW04AN27NJ00□	27nH±5%	100MHz	160mA	0.95ohm	15	250MHz	4.0GHz
LQW04AN33NH00□	33nH±3%	100MHz	140mA	1.11ohm	15	250MHz	4.0GHz
LQW04AN33NJ00□	33nH±5%	100MHz	140mA	1.11ohm	15	250MHz	4.0GHz

Operating Temperature Range: -55°C to +125°C Only for reflow soldering.

Continued from the preceding page.

■ Q - Frequency Characteristics (Typ.)

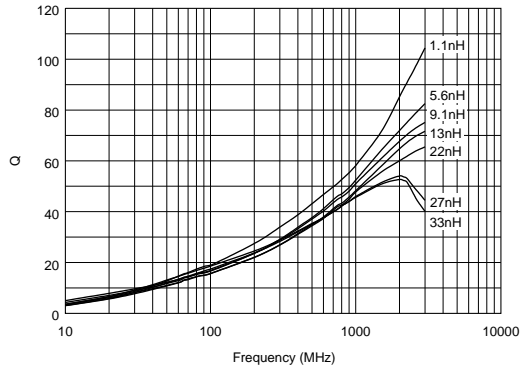

■ Inductance - Frequency Characteristics (Typ.)

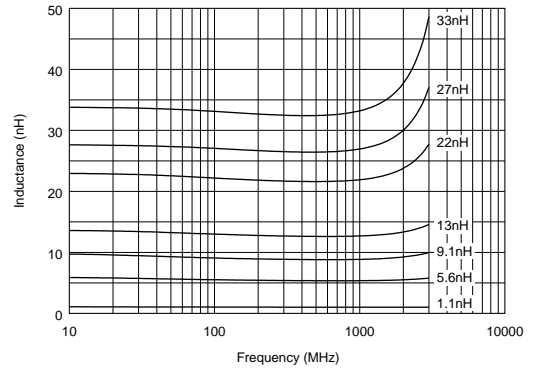

■ Reference Data

E4991A & 16197A

Part Number	Inductance (nH) Nominal	Q (Typ.)						
		300MHz	800MHz	900MHz	1.5GHz	1.8GHz	2.0GHz	2.4GHz
LQW04AN1N1	1.1	32	61	65	72	79	85	92
LQW04AN1N8	1.8	30	48	52	67	75	80	88
LQW04AN2N7	2.7	28	46	50	65	70	75	85
LQW04AN3N0	3.0	29	47	50	65	70	75	85
LQW04AN3N6	3.6	28	46	48	64	69	72	78
LQW04AN3N9	3.9	27	46	48	64	69	72	79
LQW04AN4N3	4.3	29	47	50	64	69	73	79
LQW04AN4N7	4.7	26	43	45	58	63	67	72
LQW04AN5N1	5.1	30	47	49	62	69	72	80
LQW04AN5N6	5.6	29	47	49	62	69	72	79
LQW04AN6N2	6.2	26	42	45	58	63	65	70
LQW04AN6N8	6.8	28	45	48	60	66	68	74
LQW04AN7N5	7.5	28	45	47	60	66	67	70
LQW04AN8N2	8.2	27	43	45	57	61	63	67
LQW04AN9N1	9.1	28	45	47	58	65	66	68
LQW04AN10N	10	27	43	46	56	61	63	65
LQW04AN11N	11	27	43	46	58	63	65	67
LQW04AN12N	12	28	44	47	58	63	64	66
LQW04AN13N	13	27	44	46	58	62	64	66
LQW04AN15N	15	27	43	45	55	59	60	61
LQW04AN16N	16	27	43	47	56	60	61	61
LQW04AN18N	18	27	42	45	55	57	58	57
LQW04AN20N	20	27	42	45	54	57	58	55
LQW04AN22N	22	27	42	46	54	56	57	55
LQW04AN27N	27	30	42	44	50	51	50	47
LQW04AN33N	33	30	43	45	52	52	50	47

Chip Coils for High Frequency Horizontal Wire Wound



LQW15A_00 Series (0402 Size)

LQW15A series consists of air core chip coil using a miniature alumina core.

The tight inductance tolerance (+-0.2nH, +-3%) is available due to Murata's original wire wound technology. LQW15A series has high Q value in high frequency range and high self-resonant frequency. It is suitable for high frequency circuits which are used in telecommunications equipment.

■ Features

1. Horizontal wire wound structure enables tight inductance tolerance (+-0.2nH, +-3%), and tolerance of +-0.1nH, +-2% is available.
2. Wide variation in inductance value.
3. The subminiature dimensions (1.0x0.5mm) allow high density mounting.
4. The high self-resonant frequency realizes high Q value and stable inductance at high frequency.
5. Low DC resistance design is ideal for low loss, high output and low power consumption.
6. Resin-coated surface enables excellent mounting.

■ Applications

1. High frequency circuits of mobile phones such as PA, ANT, VCO, SAW, etc.
2. Mobile phones
3. "Bluetooth"
4. W-LAN
5. High frequency circuits in general

■ Dimensions

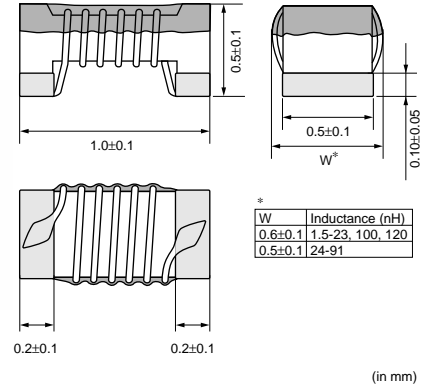

■ Rated Value (□: packaging code)

Part Number	Inductance	Test Frequency	Rated Current	Max. of DC Resistance	Q (min.)	Test Frequency	Self Resonance Frequency (min.)
LQW15AN1N5B00□	1.5nH±0.1nH	100MHz	1000mA	0.03ohm	10	250MHz	18.0GHz
LQW15AN1N5C00□	1.5nH±0.2nH	100MHz	1000mA	0.03ohm	10	250MHz	18.0GHz
LQW15AN1N5D00□	1.5nH±0.5nH	100MHz	1000mA	0.03ohm	10	250MHz	18.0GHz
LQW15AN2N4B00□	2.4nH±0.1nH	100MHz	850mA	0.05ohm	20	250MHz	15.0GHz
LQW15AN2N4C00□	2.4nH±0.2nH	100MHz	850mA	0.05ohm	20	250MHz	15.0GHz
LQW15AN2N4D00□	2.4nH±0.5nH	100MHz	850mA	0.05ohm	20	250MHz	15.0GHz
LQW15AN2N5B00□	2.5nH±0.1nH	100MHz	850mA	0.05ohm	20	250MHz	15.0GHz
LQW15AN2N5C00□	2.5nH±0.2nH	100MHz	850mA	0.05ohm	20	250MHz	15.0GHz
LQW15AN2N5D00□	2.5nH±0.5nH	100MHz	850mA	0.05ohm	20	250MHz	15.0GHz
LQW15AN2N7B00□	2.7nH±0.1nH	100MHz	850mA	0.05ohm	20	250MHz	15.0GHz
LQW15AN2N7C00□	2.7nH±0.2nH	100MHz	850mA	0.05ohm	20	250MHz	15.0GHz
LQW15AN2N7D00□	2.7nH±0.5nH	100MHz	850mA	0.05ohm	20	250MHz	15.0GHz
LQW15AN2N9B00□	2.9nH±0.1nH	100MHz	750mA	0.07ohm	20	250MHz	15.0GHz
LQW15AN2N9C00□	2.9nH±0.2nH	100MHz	750mA	0.07ohm	20	250MHz	15.0GHz
LQW15AN2N9D00□	2.9nH±0.5nH	100MHz	750mA	0.07ohm	20	250MHz	15.0GHz
LQW15AN3N9B00□	3.9nH±0.1nH	100MHz	750mA	0.07ohm	25	250MHz	10.0GHz

Operating Temperature Range: -55°C to +125°C Only for reflow soldering.

Continued on the following page. ↗

Continued from the preceding page.

3

Part Number	Inductance	Test Frequency	Rated Current	Max. of DC Resistance	Q (min.)	Test Frequency	Self Resonance Frequency (min.)
LQW15AN3N9C00□	3.9nH±0.2nH	100MHz	750mA	0.07ohm	25	250MHz	10.0GHz
LQW15AN3N9D00□	3.9nH±0.5nH	100MHz	750mA	0.07ohm	25	250MHz	10.0GHz
LQW15AN4N1B00□	4.1nH±0.1nH	100MHz	750mA	0.07ohm	25	250MHz	10.0GHz
LQW15AN4N1C00□	4.1nH±0.2nH	100MHz	750mA	0.07ohm	25	250MHz	10.0GHz
LQW15AN4N1D00□	4.1nH±0.5nH	100MHz	750mA	0.07ohm	25	250MHz	10.0GHz
LQW15AN4N3B00□	4.3nH±0.1nH	100MHz	750mA	0.07ohm	25	250MHz	10.0GHz
LQW15AN4N3C00□	4.3nH±0.2nH	100MHz	750mA	0.07ohm	25	250MHz	10.0GHz
LQW15AN4N3D00□	4.3nH±0.5nH	100MHz	750mA	0.07ohm	25	250MHz	10.0GHz
LQW15AN4N7B00□	4.7nH±0.1nH	100MHz	750mA	0.07ohm	25	250MHz	8.0GHz
LQW15AN4N7C00□	4.7nH±0.2nH	100MHz	750mA	0.07ohm	25	250MHz	8.0GHz
LQW15AN4N7D00□	4.7nH±0.5nH	100MHz	750mA	0.07ohm	25	250MHz	8.0GHz
LQW15AN5N1B00□	5.1nH±0.1nH	100MHz	600mA	0.12ohm	25	250MHz	8.0GHz
LQW15AN5N1C00□	5.1nH±0.2nH	100MHz	600mA	0.12ohm	25	250MHz	8.0GHz
LQW15AN5N1D00□	5.1nH±0.5nH	100MHz	600mA	0.12ohm	25	250MHz	8.0GHz
LQW15AN5N8B00□	5.8nH±0.1nH	100MHz	700mA	0.12ohm	25	250MHz	8.0GHz
LQW15AN5N8C00□	5.8nH±0.2nH	100MHz	700mA	0.12ohm	25	250MHz	8.0GHz
LQW15AN5N8D00□	5.8nH±0.5nH	100MHz	700mA	0.12ohm	25	250MHz	8.0GHz
LQW15AN6N2B00□	6.2nH±0.1nH	100MHz	700mA	0.09ohm	25	250MHz	8.0GHz
LQW15AN6N2C00□	6.2nH±0.2nH	100MHz	700mA	0.09ohm	25	250MHz	8.0GHz
LQW15AN6N2D00□	6.2nH±0.5nH	100MHz	700mA	0.09ohm	25	250MHz	8.0GHz
LQW15AN6N8G00□	6.8nH±2%	100MHz	700mA	0.09ohm	25	250MHz	6.0GHz
LQW15AN6N8H00□	6.8nH±3%	100MHz	700mA	0.09ohm	25	250MHz	6.0GHz
LQW15AN6N8J00□	6.8nH±5%	100MHz	700mA	0.09ohm	25	250MHz	6.0GHz
LQW15AN7N3G00□	7.3nH±2%	100MHz	570mA	0.13ohm	25	250MHz	6.0GHz
LQW15AN7N3H00□	7.3nH±3%	100MHz	570mA	0.13ohm	25	250MHz	6.0GHz
LQW15AN7N3J00□	7.3nH±5%	100MHz	570mA	0.13ohm	25	250MHz	6.0GHz
LQW15AN7N5G00□	7.5nH±2%	100MHz	570mA	0.13ohm	25	250MHz	6.0GHz
LQW15AN7N5H00□	7.5nH±3%	100MHz	570mA	0.13ohm	25	250MHz	6.0GHz
LQW15AN7N5J00□	7.5nH±5%	100MHz	570mA	0.13ohm	25	250MHz	6.0GHz
LQW15AN8N2G00□	8.2nH±2%	100MHz	540mA	0.14ohm	25	250MHz	5.5GHz
LQW15AN8N2H00□	8.2nH±3%	100MHz	540mA	0.14ohm	25	250MHz	5.5GHz
LQW15AN8N2J00□	8.2nH±5%	100MHz	540mA	0.14ohm	25	250MHz	5.5GHz
LQW15AN8N7G00□	8.7nH±2%	100MHz	540mA	0.14ohm	25	250MHz	5.5GHz
LQW15AN8N7H00□	8.7nH±3%	100MHz	540mA	0.14ohm	25	250MHz	5.5GHz
LQW15AN8N7J00□	8.7nH±5%	100MHz	540mA	0.14ohm	25	250MHz	5.5GHz
LQW15AN9N1G00□	9.1nH±2%	100MHz	540mA	0.14ohm	25	250MHz	5.5GHz
LQW15AN9N1H00□	9.1nH±3%	100MHz	540mA	0.14ohm	25	250MHz	5.5GHz
LQW15AN9N1J00□	9.1nH±5%	100MHz	540mA	0.14ohm	25	250MHz	5.5GHz
LQW15AN9N5G00□	9.5nH±2%	100MHz	540mA	0.14ohm	25	250MHz	5.5GHz
LQW15AN9N5H00□	9.5nH±3%	100MHz	540mA	0.14ohm	25	250MHz	5.5GHz
LQW15AN9N5J00□	9.5nH±5%	100MHz	540mA	0.14ohm	25	250MHz	5.5GHz
LQW15AN10NG00□	10nH±2%	100MHz	500mA	0.17ohm	25	250MHz	5.5GHz
LQW15AN10NH00□	10nH±3%	100MHz	500mA	0.17ohm	25	250MHz	5.5GHz
LQW15AN10NJ00□	10nH±5%	100MHz	500mA	0.17ohm	25	250MHz	5.5GHz
LQW15AN11NG00□	11nH±2%	100MHz	500mA	0.14ohm	30	250MHz	5.5GHz
LQW15AN11NH00□	11nH±3%	100MHz	500mA	0.14ohm	30	250MHz	5.5GHz
LQW15AN11NJ00□	11nH±5%	100MHz	500mA	0.14ohm	30	250MHz	5.5GHz
LQW15AN12NG00□	12nH±2%	100MHz	500mA	0.14ohm	30	250MHz	5.5GHz
LQW15AN12NH00□	12nH±3%	100MHz	500mA	0.14ohm	30	250MHz	5.5GHz
LQW15AN12NJ00□	12nH±5%	100MHz	500mA	0.14ohm	30	250MHz	5.5GHz
LQW15AN13NG00□	13nH±2%	100MHz	430mA	0.21ohm	25	250MHz	5.0GHz

Operating Temperature Range: -55°C to +125°C Only for reflow soldering.

Continued on the following page. 

 Continued from the preceding page.

Part Number	Inductance	Test Frequency	Rated Current	Max. of DC Resistance	Q (min.)	Test Frequency	Self Resonance Frequency (min.)
LQW15AN13NH00□	13nH±3%	100MHz	430mA	0.21ohm	25	250MHz	5.0GHz
LQW15AN13NJ00□	13nH±5%	100MHz	430mA	0.21ohm	25	250MHz	5.0GHz
LQW15AN15NG00□	15nH±2%	100MHz	460mA	0.16ohm	30	250MHz	5.0GHz
LQW15AN15NH00□	15nH±3%	100MHz	460mA	0.16ohm	30	250MHz	5.0GHz
LQW15AN15NJ00□	15nH±5%	100MHz	460mA	0.16ohm	30	250MHz	5.0GHz
LQW15AN16NG00□	16nH±2%	100MHz	370mA	0.24ohm	25	250MHz	4.5GHz
LQW15AN16NH00□	16nH±3%	100MHz	370mA	0.24ohm	25	250MHz	4.5GHz
LQW15AN16NJ00□	16nH±5%	100MHz	370mA	0.24ohm	25	250MHz	4.5GHz
LQW15AN18NG00□	18nH±2%	100MHz	370mA	0.27ohm	25	250MHz	4.5GHz
LQW15AN18NH00□	18nH±3%	100MHz	370mA	0.27ohm	25	250MHz	4.5GHz
LQW15AN18NJ00□	18nH±5%	100MHz	370mA	0.27ohm	25	250MHz	4.5GHz
LQW15AN19NG00□	19nH±2%	100MHz	370mA	0.27ohm	25	250MHz	4.5GHz
LQW15AN19NH00□	19nH±3%	100MHz	370mA	0.27ohm	25	250MHz	4.5GHz
LQW15AN19NJ00□	19nH±5%	100MHz	370mA	0.27ohm	25	250MHz	4.5GHz
LQW15AN20NG00□	20nH±2%	100MHz	370mA	0.27ohm	25	250MHz	4.0GHz
LQW15AN20NH00□	20nH±3%	100MHz	370mA	0.27ohm	25	250MHz	4.0GHz
LQW15AN20NJ00□	20nH±5%	100MHz	370mA	0.27ohm	25	250MHz	4.0GHz
LQW15AN22NG00□	22nH±2%	100MHz	310mA	0.30ohm	25	250MHz	4.0GHz
LQW15AN22NH00□	22nH±3%	100MHz	310mA	0.30ohm	25	250MHz	4.0GHz
LQW15AN22NJ00□	22nH±5%	100MHz	310mA	0.30ohm	25	250MHz	4.0GHz
LQW15AN23NG00□	23nH±2%	100MHz	310mA	0.30ohm	25	250MHz	3.8GHz
LQW15AN23NH00□	23nH±3%	100MHz	310mA	0.30ohm	25	250MHz	3.8GHz
LQW15AN23NJ00□	23nH±5%	100MHz	310mA	0.30ohm	25	250MHz	3.8GHz
LQW15AN24NG00□	24nH±2%	100MHz	280mA	0.52ohm	25	250MHz	3.5GHz
LQW15AN24NH00□	24nH±3%	100MHz	280mA	0.52ohm	25	250MHz	3.5GHz
LQW15AN24NJ00□	24nH±5%	100MHz	280mA	0.52ohm	25	250MHz	3.5GHz
LQW15AN27NG00□	27nH±2%	100MHz	280mA	0.52ohm	25	250MHz	3.5GHz
LQW15AN27NH00□	27nH±3%	100MHz	280mA	0.52ohm	25	250MHz	3.5GHz
LQW15AN27NJ00□	27nH±5%	100MHz	280mA	0.52ohm	25	250MHz	3.5GHz
LQW15AN30NG00□	30nH±2%	100MHz	270mA	0.58ohm	25	250MHz	3.3GHz
LQW15AN30NH00□	30nH±3%	100MHz	270mA	0.58ohm	25	250MHz	3.3GHz
LQW15AN30NJ00□	30nH±5%	100MHz	270mA	0.58ohm	25	250MHz	3.3GHz
LQW15AN33NG00□	33nH±2%	100MHz	260mA	0.63ohm	25	250MHz	3.2GHz
LQW15AN33NH00□	33nH±3%	100MHz	260mA	0.63ohm	25	250MHz	3.2GHz
LQW15AN33NJ00□	33nH±5%	100MHz	260mA	0.63ohm	25	250MHz	3.2GHz
LQW15AN36NG00□	36nH±2%	100MHz	260mA	0.63ohm	25	250MHz	3.1GHz
LQW15AN36NH00□	36nH±3%	100MHz	260mA	0.63ohm	25	250MHz	3.1GHz
LQW15AN36NJ00□	36nH±5%	100MHz	260mA	0.63ohm	25	250MHz	3.1GHz
LQW15AN39NG00□	39nH±2%	100MHz	250mA	0.70ohm	25	250MHz	3.0GHz
LQW15AN39NH00□	39nH±3%	100MHz	250mA	0.70ohm	25	250MHz	3.0GHz
LQW15AN39NJ00□	39nH±5%	100MHz	250mA	0.70ohm	25	250MHz	3.0GHz
LQW15AN40NG00□	40nH±2%	100MHz	250mA	0.70ohm	25	250MHz	3.0GHz
LQW15AN40NH00□	40nH±3%	100MHz	250mA	0.70ohm	25	250MHz	3.0GHz
LQW15AN40NJ00□	40nH±5%	100MHz	250mA	0.70ohm	25	250MHz	3.0GHz
LQW15AN43NG00□	43nH±2%	100MHz	250mA	0.70ohm	25	250MHz	3.0GHz
LQW15AN43NH00□	43nH±3%	100MHz	250mA	0.70ohm	25	250MHz	3.0GHz
LQW15AN43NJ00□	43nH±5%	100MHz	250mA	0.70ohm	25	250MHz	3.0GHz
LQW15AN47NG00□	47nH±2%	100MHz	210mA	1.08ohm	25	200MHz	2.9GHz
LQW15AN47NH00□	47nH±3%	100MHz	210mA	1.08ohm	25	200MHz	2.9GHz
LQW15AN47NJ00□	47nH±5%	100MHz	210mA	1.08ohm	25	200MHz	2.9GHz
LQW15AN51NG00□	51nH±2%	100MHz	210mA	1.08ohm	25	200MHz	2.85GHz

Operating Temperature Range: -55°C to +125°C Only for reflow soldering.

Continued on the following page. 

Continued from the preceding page.

Part Number	Inductance	Test Frequency	Rated Current	Max. of DC Resistance	Q (min.)	Test Frequency	Self Resonance Frequency (min.)
LQW15AN51NH00□	51nH±3%	100MHz	210mA	1.08ohm	25	200MHz	2.85GHz
LQW15AN51NJ00□	51nH±5%	100MHz	210mA	1.08ohm	25	200MHz	2.85GHz
LQW15AN56NG00□	56nH±2%	100MHz	200mA	1.17ohm	25	200MHz	2.8GHz
LQW15AN56NH00□	56nH±3%	100MHz	200mA	1.17ohm	25	200MHz	2.8GHz
LQW15AN56NJ00□	56nH±5%	100MHz	200mA	1.17ohm	25	200MHz	2.8GHz
LQW15AN62NG00□	62nH±2%	100MHz	145mA	1.82ohm	20	200MHz	2.6GHz
LQW15AN62NH00□	62nH±3%	100MHz	145mA	1.82ohm	20	200MHz	2.6GHz
LQW15AN62NJ00□	62nH±5%	100MHz	145mA	1.82ohm	20	200MHz	2.6GHz
LQW15AN68NG00□	68nH±2%	100MHz	140mA	1.96ohm	20	200MHz	2.5GHz
LQW15AN68NJ00□	68nH±5%	100MHz	140mA	1.96ohm	20	200MHz	2.5GHz
LQW15AN72NG00□	72nH±2%	100MHz	135mA	2.10ohm	20	150MHz	2.5GHz
LQW15AN72NJ00□	72nH±5%	100MHz	135mA	2.10ohm	20	150MHz	2.5GHz
LQW15AN75NG00□	75nH±2%	100MHz	135mA	2.10ohm	20	150MHz	2.4GHz
LQW15AN75NJ00□	75nH±5%	100MHz	135mA	2.10ohm	20	150MHz	2.4GHz
LQW15AN82NG00□	82nH±2%	100MHz	130mA	2.24ohm	20	150MHz	2.3GHz
LQW15AN82NJ00□	82nH±5%	100MHz	130mA	2.24ohm	20	150MHz	2.3GHz
LQW15AN91NG00□	91nH±2%	100MHz	125mA	2.38ohm	20	150MHz	2.1GHz
LQW15AN91NJ00□	91nH±5%	100MHz	125mA	2.38ohm	20	150MHz	2.1GHz
LQW15ANR10J00□	100nH±5%	100MHz	120mA	2.52ohm	20	150MHz	1.5GHz
LQW15ANR12J00□	120nH±5%	100MHz	110mA	2.66ohm	20	150MHz	1.0GHz

Operating Temperature Range: -55°C to +125°C Only for reflow soldering.

■ Q - Frequency Characteristics (Typ.)

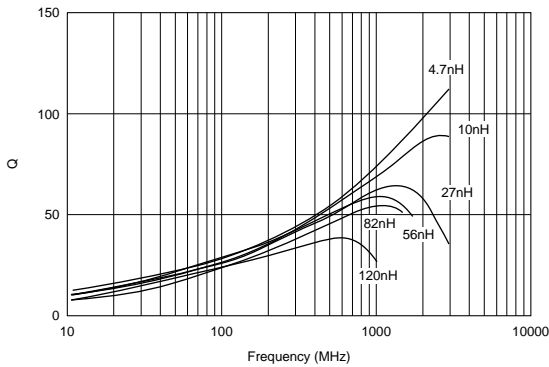

■ Inductance - Frequency Characteristics (Typ.)

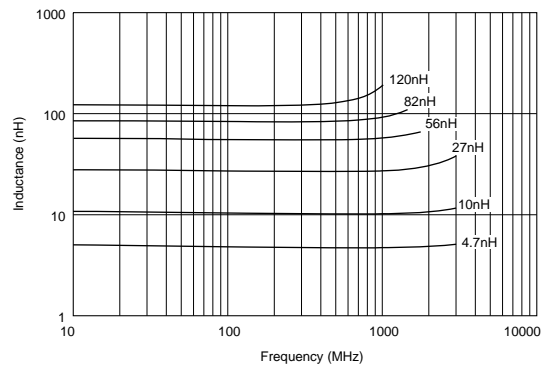

Continued on the following page.

Continued from the preceding page.

Reference Data

LQW15AN_00

E4991A & 16197A

Part Number	Inductance (nH)	Q (Typ.)						
	Nominal	300MHz	800MHz	900MHz	1.5GHz	1.8GHz	2.0GHz	2.4GHz
LQW15AN1N5	1.5	30	55	60	65	90	100	115
LQW15AN2N4	2.4	40	65	67	80	98	108	120
LQW15AN2N5	2.5	40	65	67	88	90	100	110
LQW15AN2N7	2.7	40	67	73	85	100	105	120
LQW15AN2N9	2.9	33	53	58	75	80	85	92
LQW15AN3N9	3.9	35	58	61	82	88	92	100
LQW15AN4N1	4.1	35	58	61	82	88	92	100
LQW15AN4N3	4.3	35	58	61	90	88	92	100
LQW15AN4N7	4.7	40	65	67	85	88	92	95
LQW15AN5N1	5.1	35	60	65	78	85	90	95
LQW15AN5N8	5.8	40	63	67	85	88	92	105
LQW15AN6N2	6.2	40	63	65	80	90	95	105
LQW15AN6N8	6.8	45	70	72	90	96	100	103
LQW15AN7N3	7.3	38	58	63	75	88	90	92
LQW15AN7N5	7.5	38	58	63	75	88	90	92
LQW15AN8N2	8.2	40	62	67	80	90	95	102
LQW15AN8N7	8.7	40	60	62	80	85	90	92
LQW15AN9N1	9.1	40	62	68	85	90	92	95
LQW15AN9N5	9.5	40	62	68	85	90	92	95
LQW15AN10N	10	38	60	65	75	82	85	84
LQW15AN11N	11	40	65	70	90	105	110	120
LQW15AN12N	12	40	60	62	80	85	90	91
LQW15AN13N	13	40	60	62	70	72	71	67
LQW15AN15N	15	40	60	65	80	85	88	90
LQW15AN16N	16	40	60	63	80	90	100	110
LQW15AN18N	18	40	63	65	80	88	87	85
LQW15AN19N	19	37	57	62	78	80	82	83
LQW15AN20N	20	37	57	62	78	80	82	83
LQW15AN22N	22	35	55	58	73	75	78	-
LQW15AN23N	23	35	55	58	73	75	78	-
LQW15AN24N	24	35	50	50	48	42	-	-
LQW15AN27N	27	35	55	56	60	58	-	-
LQW15AN30N	30	35	55	58	65	68	-	-
LQW15AN33N	33	35	55	56	60	53	-	-
LQW15AN36N	36	35	52	52	48	42	-	-
LQW15AN39N	39	35	55	56	62	-	-	-
LQW15AN40N	40	35	55	56	62	-	-	-
LQW15AN43N	43	35	55	56	62	-	-	-
LQW15AN47N	47	34	52	54	60	-	-	-
LQW15AN51N	51	34	52	54	60	-	-	-
LQW15AN56N	56	36	53	55	50	-	-	-
LQW15AN62N	62	33	51	52	-	-	-	-
LQW15AN68N	68	35	49	52	-	-	-	-
LQW15AN72N	72	33	49	52	-	-	-	-
LQW15AN75N	75	33	49	52	-	-	-	-
LQW15AN82N	82	35	49	50	-	-	-	-
LQW15AN91N	91	35	52	53	-	-	-	-
LQW15ANR10	100	30	43	43	-	-	-	-
LQW15ANR12	120	28	30	23	-	-	-	-

3

Chip Coils for High Frequency Horizontal Wire Wound



LQW15A_10 Series (High Q/Low DC Resistance Type) (0402 Size)

3

■ Features

Lower DC resistance approximately by 50% than current type. Higher Q by 20%, larger rated current by 20%.
 Inductance range: 1.3 to 5.6nH
 Inductance tolerance: ± 0.2 or 0.5 nH
 Q (Typ.): 83 to 122 (at 1GHz)
 DC Resistance: 0.017 to 0.051 ohm
 Rated Current: 800 to 1200mA

■ Applications

1. Mobile phones
2. Higher Q -- Matching circuit for antenna, SAWFIL
3. Lower Rdc -- Choke coil for IF, RF circuit like PA Equipment with high frequency circuits (Wireless LAN, etc.)

■ Dimensions

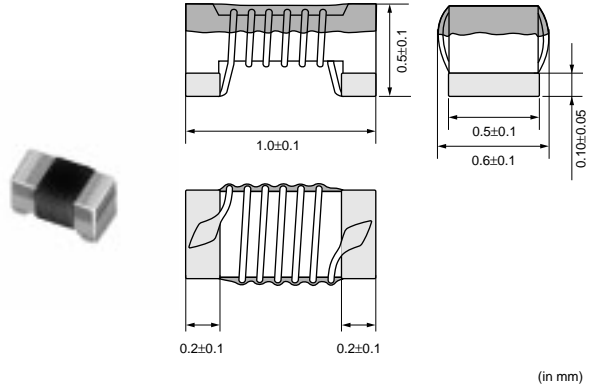

■ Rated Value (□: packaging code)

Part Number	Inductance	Test Frequency	Rated Current	Max. of DC Resistance	Q (min.)	Test Frequency	Self Resonance Frequency (min.)
LQW15AN1N3C10□	1.3nH ± 0.2 nH	100MHz	1200mA	0.017ohm	20	250MHz	16.0GHz
LQW15AN1N3D10□	1.3nH ± 0.5 nH	100MHz	1200mA	0.017ohm	20	250MHz	16.0GHz
LQW15AN2N2C10□	2.2nH ± 0.2 nH	100MHz	1000mA	0.027ohm	25	250MHz	14.0GHz
LQW15AN2N2D10□	2.2nH ± 0.5 nH	100MHz	1000mA	0.027ohm	25	250MHz	14.0GHz
LQW15AN2N4D10□	2.4nH ± 0.5 nH	100MHz	1000mA	0.027ohm	25	250MHz	14.0GHz
LQW15AN3N3D10□	3.3nH ± 0.5 nH	100MHz	900mA	0.040ohm	30	250MHz	12.0GHz
LQW15AN3N4C10□	3.4nH ± 0.2 nH	100MHz	900mA	0.040ohm	30	250MHz	12.0GHz
LQW15AN3N4D10□	3.4nH ± 0.5 nH	100MHz	900mA	0.040ohm	30	250MHz	12.0GHz
LQW15AN3N6C10□	3.6nH ± 0.2 nH	100MHz	900mA	0.040ohm	30	250MHz	9.5GHz
LQW15AN3N6D10□	3.6nH ± 0.5 nH	100MHz	900mA	0.040ohm	30	250MHz	9.5GHz
LQW15AN3N9D10□	3.9nH ± 0.5 nH	100MHz	900mA	0.040ohm	30	250MHz	7.0GHz
LQW15AN4N7D10□	4.7nH ± 0.5 nH	100MHz	800mA	0.051ohm	30	250MHz	8.0GHz
LQW15AN5N1C10□	5.1nH ± 0.2 nH	100MHz	800mA	0.051ohm	30	250MHz	8.0GHz
LQW15AN5N1D10□	5.1nH ± 0.5 nH	100MHz	800mA	0.051ohm	30	250MHz	8.0GHz
LQW15AN5N6C10□	5.6nH ± 0.2 nH	100MHz	800mA	0.051ohm	30	250MHz	8.0GHz
LQW15AN5N6D10□	5.6nH ± 0.5 nH	100MHz	800mA	0.051ohm	30	250MHz	8.0GHz

Operating Temperature Range: -55°C to +125°C Only for reflow soldering.

■ Q - Frequency Characteristics (Typ.)

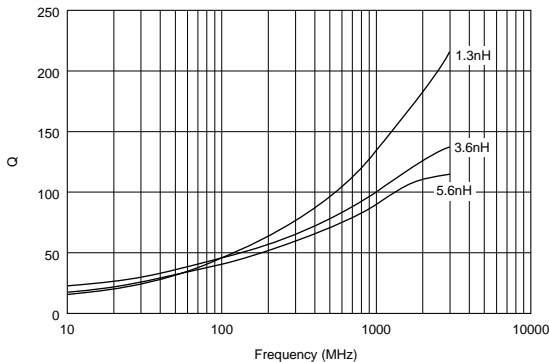

■ Inductance - Frequency Characteristics (Typ.)

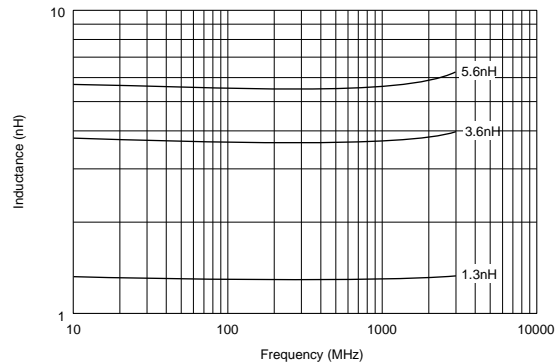

Continued on the following page.

 Continued from the preceding page.

■ Reference Data

LQW15AN_10

E4991A & 16197A

Part Number	Inductance (nH)	Q (Typ.)						
	Nominal	800MHz	900MHz	1.0GHz	1.5GHz	1.8GHz	2.0GHz	2.4GHz
LQW15AN1N3	1.3	90	95	100	130	145	160	180
LQW15AN2N2	2.2	85	90	95	115	130	140	160
LQW15AN2N4	2.4	80	85	90	110	130	140	160
LQW15AN3N3	3.3	80	85	90	110	120	128	140
LQW15AN3N4	3.4	80	85	90	110	120	128	140
LQW15AN3N6	3.6	73	75	85	100	110	115	130
LQW15AN3N9	3.9	75	80	83	95	110	115	120
LQW15AN4N7	4.7	75	80	85	100	113	120	132
LQW15AN5N1	5.1	75	80	85	100	110	115	128
LQW15AN5N6	5.6	70	75	78	95	100	105	110

Chip Coils for High Frequency Horizontal Wire Wound



LQW18A_00 Series (0603 Size)

3

■ Features

1. Broad range of inductance (2.2nH to 470nH) with E24 step line up.
2. Horizontal wire wound structure enables tight inductance tolerance (+/-0.2nH, +/-2%). Stable circuit operation is possible.
3. The subminiature dimensions (1.6x0.8mm) allow high density mounting.
4. The high self-resonant frequency realizes high Q value and stable inductance at high frequency.
5. Low DC resistance design is ideal for low loss, high output and low power consumption.
6. Resin-coated surface enables excellent mounting.

■ Dimensions

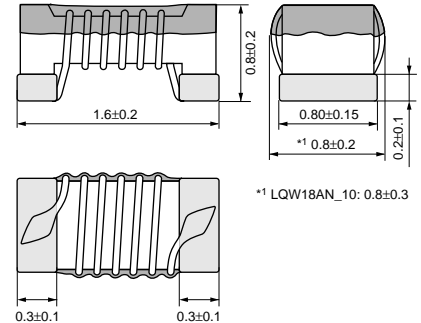

(in mm)

■ Applications

1. High frequency circuits of mobile phones such as PA, ANT, VCO, SAW, etc.
2. Mobile phones
3. "Bluetooth"
4. W-LAN
5. High frequency circuits in general

■ Rated Value (□: packaging code)

Part Number	Inductance	Test Frequency	Rated Current	Max. of DC Resistance	Q (min.)	Test Frequency	Self Resonance Frequency (min.)
LQW18AN2N2D00□	2.2nH±0.5nH	100MHz	700mA	0.049ohm	16	250MHz	6000MHz
LQW18AN3N6C00□	3.6nH±0.2nH	100MHz	850mA	0.059ohm	25	250MHz	6000MHz
LQW18AN3N6D00□	3.6nH±0.5nH	100MHz	850mA	0.059ohm	25	250MHz	6000MHz
LQW18AN3N9C00□	3.9nH±0.2nH	100MHz	850mA	0.059ohm	35	250MHz	6000MHz
LQW18AN3N9D00□	3.9nH±0.5nH	100MHz	850mA	0.059ohm	35	250MHz	6000MHz
LQW18AN4N3C00□	4.3nH±0.2nH	100MHz	850mA	0.059ohm	35	250MHz	6000MHz
LQW18AN4N3D00□	4.3nH±0.5nH	100MHz	850mA	0.059ohm	35	250MHz	6000MHz
LQW18AN4N7D00□	4.7nH±0.5nH	100MHz	850mA	0.059ohm	35	250MHz	6000MHz
LQW18AN5N6C00□	5.6nH±0.2nH	100MHz	750mA	0.082ohm	35	250MHz	6000MHz
LQW18AN5N6D00□	5.6nH±0.5nH	100MHz	750mA	0.082ohm	35	250MHz	6000MHz
LQW18AN6N2C00□	6.2nH±0.2nH	100MHz	750mA	0.082ohm	35	250MHz	6000MHz
LQW18AN6N2D00□	6.2nH±0.5nH	100MHz	750mA	0.082ohm	35	250MHz	6000MHz
LQW18AN6N8C00□	6.8nH±0.2nH	100MHz	750mA	0.082ohm	35	250MHz	6000MHz
LQW18AN6N8D00□	6.8nH±0.5nH	100MHz	750mA	0.082ohm	35	250MHz	6000MHz
LQW18AN7N5D00□	7.5nH±0.5nH	100MHz	750mA	0.082ohm	35	250MHz	6000MHz
LQW18AN8N2D00□	8.2nH±0.5nH	100MHz	650mA	0.11ohm	35	250MHz	6000MHz
LQW18AN8N7D00□	8.7nH±0.5nH	100MHz	650mA	0.11ohm	35	250MHz	6000MHz
LQW18AN9N1D00□	9.1nH±0.5nH	100MHz	650mA	0.11ohm	35	250MHz	6000MHz
LQW18AN9N5D00□	9.5nH±0.5nH	100MHz	650mA	0.11ohm	35	250MHz	6000MHz
LQW18AN10NG00□	10nH±2%	100MHz	650mA	0.11ohm	35	250MHz	6000MHz
LQW18AN10NJ00□	10nH±5%	100MHz	650mA	0.11ohm	35	250MHz	6000MHz
LQW18AN11NG00□	11nH±2%	100MHz	650mA	0.11ohm	35	250MHz	6000MHz
LQW18AN11NJ00□	11nH±5%	100MHz	650mA	0.11ohm	35	250MHz	6000MHz

Operating Temperature Range: -55°C to +125°C Only for reflow soldering.

Continued on the following page.

Continued from the preceding page.

Part Number	Inductance	Test Frequency	Rated Current	Max. of DC Resistance	Q (min.)	Test Frequency	Self Resonance Frequency (min.)
LQW18AN12NG00□	12nH±2%	100MHz	600mA	0.13ohm	35	250MHz	6000MHz
LQW18AN12NJ00□	12nH±5%	100MHz	600mA	0.13ohm	35	250MHz	6000MHz
LQW18AN13NG00□	13nH±2%	100MHz	600mA	0.13ohm	35	250MHz	6000MHz
LQW18AN13NJ00□	13nH±5%	100MHz	600mA	0.13ohm	35	250MHz	6000MHz
LQW18AN15NG00□	15nH±2%	100MHz	600mA	0.13ohm	40	250MHz	6000MHz
LQW18AN15NJ00□	15nH±5%	100MHz	600mA	0.13ohm	40	250MHz	6000MHz
LQW18AN16NG00□	16nH±2%	100MHz	550mA	0.16ohm	40	250MHz	5500MHz
LQW18AN16NJ00□	16nH±5%	100MHz	550mA	0.16ohm	40	250MHz	5500MHz
LQW18AN18NG00□	18nH±2%	100MHz	550mA	0.16ohm	40	250MHz	5500MHz
LQW18AN18NJ00□	18nH±5%	100MHz	550mA	0.16ohm	40	250MHz	5500MHz
LQW18AN20NG00□	20nH±2%	100MHz	550mA	0.16ohm	40	250MHz	4900MHz
LQW18AN20NJ00□	20nH±5%	100MHz	550mA	0.16ohm	40	250MHz	4900MHz
LQW18AN22NG00□	22nH±2%	100MHz	500mA	0.17ohm	40	250MHz	4600MHz
LQW18AN22NJ00□	22nH±5%	100MHz	500mA	0.17ohm	40	250MHz	4600MHz
LQW18AN24NG00□	24nH±2%	100MHz	500mA	0.21ohm	40	250MHz	3800MHz
LQW18AN24NJ00□	24nH±5%	100MHz	500mA	0.21ohm	40	250MHz	3800MHz
LQW18AN27NG00□	27nH±2%	100MHz	440mA	0.21ohm	40	250MHz	3700MHz
LQW18AN27NJ00□	27nH±5%	100MHz	440mA	0.21ohm	40	250MHz	3700MHz
LQW18AN30NG00□	30nH±2%	100MHz	420mA	0.23ohm	40	250MHz	3300MHz
LQW18AN30NJ00□	30nH±5%	100MHz	420mA	0.23ohm	40	250MHz	3300MHz
LQW18AN33NG00□	33nH±2%	100MHz	420mA	0.23ohm	40	250MHz	3200MHz
LQW18AN33NJ00□	33nH±5%	100MHz	420mA	0.23ohm	40	250MHz	3200MHz
LQW18AN36NG00□	36nH±2%	100MHz	400mA	0.26ohm	40	250MHz	2900MHz
LQW18AN36NJ00□	36nH±5%	100MHz	400mA	0.26ohm	40	250MHz	2900MHz
LQW18AN39NG00□	39nH±2%	100MHz	400mA	0.26ohm	40	250MHz	2800MHz
LQW18AN39NJ00□	39nH±5%	100MHz	400mA	0.26ohm	40	250MHz	2800MHz
LQW18AN43NG00□	43nH±2%	100MHz	380mA	0.29ohm	40	200MHz	2700MHz
LQW18AN43NJ00□	43nH±5%	100MHz	380mA	0.29ohm	40	200MHz	2700MHz
LQW18AN47NG00□	47nH±2%	100MHz	380mA	0.29ohm	38	200MHz	2600MHz
LQW18AN47NJ00□	47nH±5%	100MHz	380mA	0.29ohm	38	200MHz	2600MHz
LQW18AN51NG00□	51nH±2%	100MHz	370mA	0.33ohm	38	200MHz	2500MHz
LQW18AN51NJ00□	51nH±5%	100MHz	370mA	0.33ohm	38	200MHz	2500MHz
LQW18AN56NG00□	56nH±2%	100MHz	360mA	0.35ohm	38	200MHz	2400MHz
LQW18AN56NJ00□	56nH±5%	100MHz	360mA	0.35ohm	38	200MHz	2400MHz
LQW18AN62NG00□	62nH±2%	100MHz	280mA	0.51ohm	38	200MHz	2300MHz
LQW18AN62NJ00□	62nH±5%	100MHz	280mA	0.51ohm	38	200MHz	2300MHz
LQW18AN68NG00□	68nH±2%	100MHz	340mA	0.38ohm	38	200MHz	2200MHz
LQW18AN68NJ00□	68nH±5%	100MHz	340mA	0.38ohm	38	200MHz	2200MHz
LQW18AN72NG00□	72nH±2%	100MHz	270mA	0.56ohm	34	150MHz	2100MHz
LQW18AN72NJ00□	72nH±5%	100MHz	270mA	0.56ohm	34	150MHz	2100MHz
LQW18AN75NG00□	75nH±2%	100MHz	270mA	0.56ohm	34	150MHz	2050MHz
LQW18AN75NJ00□	75nH±5%	100MHz	270mA	0.56ohm	34	150MHz	2050MHz
LQW18AN82NG00□	82nH±2%	100MHz	250mA	0.60ohm	34	150MHz	2000MHz
LQW18AN82NJ00□	82nH±5%	100MHz	250mA	0.60ohm	34	150MHz	2000MHz
LQW18AN91NG00□	91nH±2%	100MHz	230mA	0.64ohm	34	150MHz	1900MHz
LQW18AN91NJ00□	91nH±5%	100MHz	230mA	0.64ohm	34	150MHz	1900MHz
LQW18ANR10G00□	100nH±2%	100MHz	220mA	0.68ohm	34	150MHz	1800MHz
LQW18ANR10J00□	100nH±5%	100MHz	220mA	0.68ohm	34	150MHz	1800MHz
LQW18ANR11G00□	110nH±2%	100MHz	200mA	1.2ohm	32	150MHz	1700MHz
LQW18ANR11J00□	110nH±5%	100MHz	200mA	1.2ohm	32	150MHz	1700MHz
LQW18ANR12G00□	120nH±2%	100MHz	180mA	1.3ohm	32	150MHz	1600MHz

Operating Temperature Range: -55°C to +125°C Only for reflow soldering.

Continued on the following page. ↗

Continued from the preceding page.

Part Number	Inductance	Test Frequency	Rated Current	Max. of DC Resistance	Q (min.)	Test Frequency	Self Resonance Frequency (min.)
LQW18ANR12J00□	120nH±5%	100MHz	180mA	1.3ohm	32	150MHz	1600MHz
LQW18ANR13G00□	130nH±2%	100MHz	170mA	1.4ohm	32	150MHz	1450MHz
LQW18ANR13J00□	130nH±5%	100MHz	170mA	1.4ohm	32	150MHz	1450MHz
LQW18ANR15G00□	150nH±2%	100MHz	160mA	1.5ohm	32	150MHz	1400MHz
LQW18ANR15J00□	150nH±5%	100MHz	160mA	1.5ohm	32	150MHz	1400MHz
LQW18ANR16G00□	160nH±2%	100MHz	150mA	2.1ohm	32	150MHz	1350MHz
LQW18ANR16J00□	160nH±5%	100MHz	150mA	2.1ohm	32	150MHz	1350MHz
LQW18ANR18G00□	180nH±2%	100MHz	140mA	2.2ohm	25	100MHz	1300MHz
LQW18ANR18J00□	180nH±5%	100MHz	140mA	2.2ohm	25	100MHz	1300MHz
LQW18ANR20G00□	200nH±2%	100MHz	120mA	2.4ohm	25	100MHz	1250MHz
LQW18ANR20J00□	200nH±5%	100MHz	120mA	2.4ohm	25	100MHz	1250MHz
LQW18ANR22G00□	220nH±2%	100MHz	120mA	2.5ohm	25	100MHz	1200MHz
LQW18ANR22J00□	220nH±5%	100MHz	120mA	2.5ohm	25	100MHz	1200MHz
LQW18ANR27G00□	270nH±2%	100MHz	110mA	3.4ohm	30	100MHz	960MHz
LQW18ANR27J00□	270nH±5%	100MHz	110mA	3.4ohm	30	100MHz	960MHz
LQW18ANR33G00□	330nH±2%	100MHz	85mA	5.5ohm	30	100MHz	800MHz
LQW18ANR33J00□	330nH±5%	100MHz	85mA	5.5ohm	30	100MHz	800MHz
LQW18ANR39G00□	390nH±2%	100MHz	80mA	6.2ohm	30	100MHz	800MHz
LQW18ANR39J00□	390nH±5%	100MHz	80mA	6.2ohm	30	100MHz	800MHz
LQW18ANR47G00□	470nH±2%	100MHz	75mA	7.0ohm	30	100MHz	700MHz
LQW18ANR47J00□	470nH±5%	100MHz	75mA	7.0ohm	30	100MHz	700MHz

Operating Temperature Range: -55°C to +125°C Only for reflow soldering.

■ Q - Frequency Characteristics (Typ.)

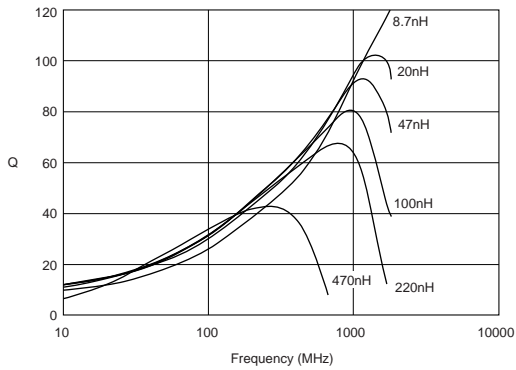

■ Inductance - Frequency Characteristics (Typ.)

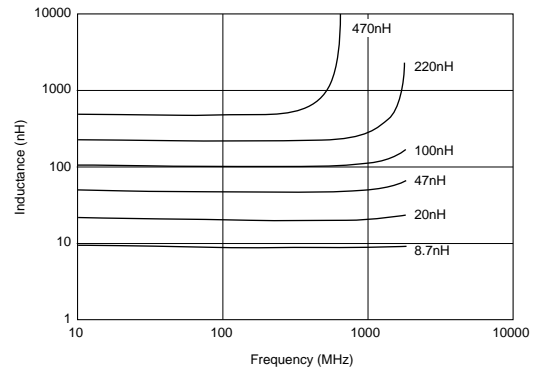

Chip Coils for High Frequency Horizontal Wire Wound



LQW18A_10 Series (High Q/Low DC Resistance Type) (0603 Size)

■ Features

DC Resistance is about 50% less than current type.
 Q is about 10% higher, and allowable current is about 20% higher than current type. Tight inductance tolerance is available.

■ Applications

Mobile phone and Base station etc.
 Higher Q -- Matching circuit for antenna, SAWFIL
 Lower Rdc -- Choke coil for IF, RF circuit like PA
 Equipment with high frequency circuits
 (Wireless LAN etc.)

■ Dimensions

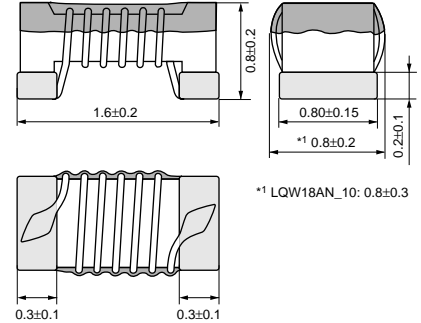

(in mm)

■ Rated Value (□: packaging code)

Part Number	Inductance	Test Frequency	Rated Current	Max. of DC Resistance	Q (min.)	Test Frequency	Self Resonance Frequency (min.)
LQW18AN2N2D10□	2.2nH±0.5nH	100MHz	1400mA	0.018ohm	25	250MHz	18000MHz
LQW18AN3N9C10□	3.9nH±0.2nH	100MHz	1000mA	0.032ohm	38	250MHz	11000MHz
LQW18AN3N9D10□	3.9nH±0.5nH	100MHz	1000mA	0.032ohm	38	250MHz	11000MHz
LQW18AN5N6D10□	5.6nH±0.5nH	100MHz	900mA	0.045ohm	38	250MHz	10000MHz
LQW18AN6N8C10□	6.8nH±0.2nH	100MHz	900mA	0.045ohm	38	250MHz	7000MHz
LQW18AN6N8D10□	6.8nH±0.5nH	100MHz	900mA	0.045ohm	38	250MHz	7000MHz
LQW18AN8N2D10□	8.2nH±0.5nH	100MHz	800mA	0.058ohm	38	250MHz	7000MHz
LQW18AN10NG10□	10nH±2%	100MHz	800mA	0.058ohm	38	250MHz	5000MHz
LQW18AN10NJ10□	10nH±5%	100MHz	800mA	0.058ohm	38	250MHz	5000MHz
LQW18AN12NG10□	12nH±2%	100MHz	750mA	0.071ohm	38	250MHz	5000MHz
LQW18AN12NJ10□	12nH±5%	100MHz	750mA	0.071ohm	38	250MHz	5000MHz
LQW18AN15NJ10□	15nH±5%	100MHz	700mA	0.085ohm	42	250MHz	4500MHz
LQW18AN18NG10□	18nH±2%	100MHz	700mA	0.085ohm	42	250MHz	3500MHz
LQW18AN18NJ10□	18nH±5%	100MHz	700mA	0.085ohm	42	250MHz	3500MHz
LQW18AN22NG10□	22nH±2%	100MHz	640mA	0.099ohm	42	250MHz	3200MHz
LQW18AN22NJ10□	22nH±5%	100MHz	640mA	0.099ohm	42	250MHz	3200MHz
LQW18AN27NG10□	27nH±2%	100MHz	590mA	0.116ohm	42	250MHz	2800MHz
LQW18AN27NJ10□	27nH±5%	100MHz	590mA	0.116ohm	42	250MHz	2800MHz
LQW18AN33NJ10□	33nH±5%	100MHz	550mA	0.132ohm	42	250MHz	2500MHz

Operating Temperature Range: -55°C to +125°C

■ Q - Frequency Characteristics (Typ.)

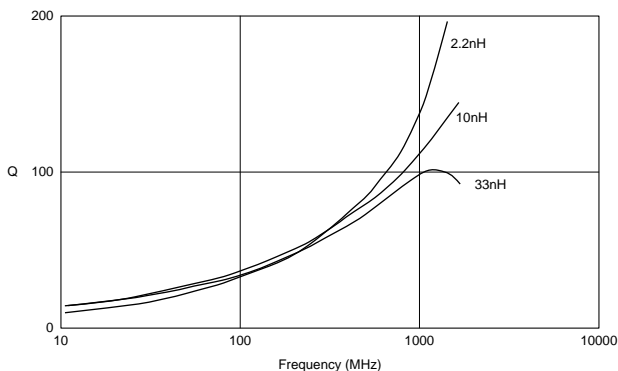

■ Inductance - Frequency Characteristics (Typ.)

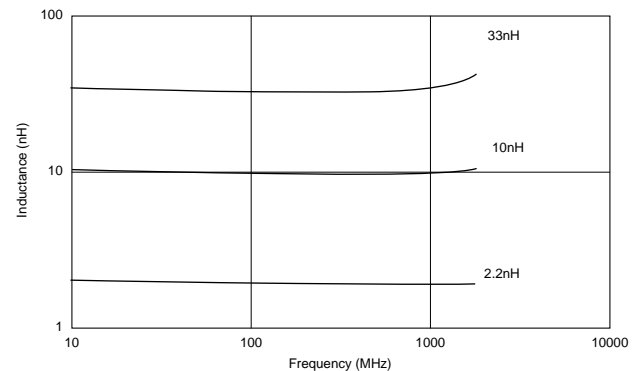

Chip Coils for High Frequency Vertical Wire Wound



LQW2BH Series (0805 Size)

LQW2BH series consists of air-core chip coil using a sub-miniature alumina core as a bobbin. The series has excellent solder heat resistance. Applicable soldering methods are both flow soldering and reflow soldering.

■ Dimensions

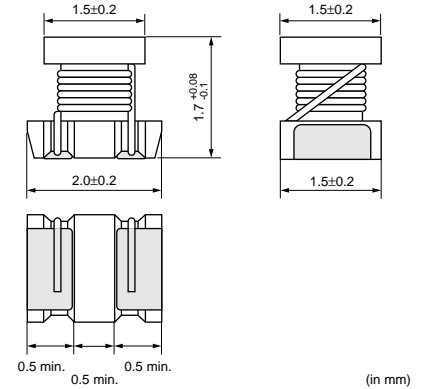

4

■ Features (LQW2BH_03)

1. Inductance: 3.3 to 470nH (Wide inductance ranges)
2. High self-resonant frequency characteristics
3. High Q value and highly stable inductance in high frequency
4. Low DC resistance and large rated current

■ Features (LQW2BH_13)

LQW2BH_13 using thick wire has higher Q value than existing LQW2BH_03 series.

1. Inductance: 2.7 to 27nH
2. DC resistance: 0.02 to 0.06 ohm
3. Q value: 85 to 95 (Typ.) at 800MHz
4. Rated current: 900 to 1900mA

■ Applications

1. High frequency circuit in telecommunications equipment
2. Impedance Matching
 - PA module
 - SAW filter
3. Resonance circuit
 - VCO

LQW2BH_03 Series

■ Rated Value (□: packaging code)

Part Number	Inductance	Test Frequency	Rated Current	Max. of DC Resistance	Q (min.)	Test Frequency	Self Resonance Frequency (min.)
LQW2BHN3N3D03□	3.3nH±0.5nH	100MHz	910mA	0.05ohm	10	250MHz	6000MHz
LQW2BHN6N8D03□	6.8nH±0.5nH	100MHz	680mA	0.11ohm	20	250MHz	5400MHz
LQW2BHN8N2D03□	8.2nH±0.5nH	100MHz	630mA	0.12ohm	20	250MHz	3900MHz
LQW2BHN10NJ03□	10nH±5%	100MHz	1320mA	0.03ohm	30	250MHz	3300MHz
LQW2BHN12NJ03□	12nH±5%	100MHz	680mA	0.11ohm	30	250MHz	3200MHz
LQW2BHN15NJ03□	15nH±5%	100MHz	630mA	0.12ohm	30	250MHz	2700MHz
LQW2BHN18NJ03□	18nH±5%	100MHz	690mA	0.10ohm	30	250MHz	2600MHz
LQW2BHN22NJ03□	22nH±5%	100MHz	720mA	0.09ohm	30	250MHz	2100MHz
LQW2BHN27NJ03□	27nH±5%	100MHz	540mA	0.17ohm	40	250MHz	2300MHz
LQW2BHN33NG03□	33nH±2%	100MHz	570mA	0.15ohm	40	250MHz	1900MHz
LQW2BHN33NJ03□	33nH±5%	100MHz	570mA	0.15ohm	40	250MHz	1900MHz
LQW2BHN39NG03□	39nH±2%	100MHz	730mA	0.09ohm	40	250MHz	1700MHz
LQW2BHN39NJ03□	39nH±5%	100MHz	730mA	0.09ohm	40	250MHz	1700MHz
LQW2BHN47NG03□	47nH±2%	100MHz	450mA	0.23ohm	40	200MHz	1600MHz

Operating Temperature Range: -40°C to +85°C

Continued on the following page.

 Continued from the preceding page.

Part Number	Inductance	Test Frequency	Rated Current	Max. of DC Resistance	Q (min.)	Test Frequency	Self Resonance Frequency (min.)
LQW2BHN47NJ03□	47nH±5%	100MHz	450mA	0.23ohm	40	200MHz	1600MHz
LQW2BHN56NG03□	56nH±2%	100MHz	430mA	0.26ohm	40	200MHz	1500MHz
LQW2BHN56NJ03□	56nH±5%	100MHz	430mA	0.26ohm	40	200MHz	1500MHz
LQW2BHN68NG03□	68nH±2%	100MHz	460mA	0.23ohm	40	200MHz	1200MHz
LQW2BHN68NJ03□	68nH±5%	100MHz	460mA	0.23ohm	40	200MHz	1200MHz
LQW2BHN82NG03□	82nH±2%	100MHz	320mA	0.42ohm	40	150MHz	1100MHz
LQW2BHN82NJ03□	82nH±5%	100MHz	320mA	0.42ohm	40	150MHz	1100MHz
LQW2BHNR10G03□	100nH±2%	100MHz	270mA	0.55ohm	35	150MHz	900MHz
LQW2BHNR10J03□	100nH±5%	100MHz	350mA	0.38ohm	40	150MHz	900MHz
LQW2BHNR12G03□	120nH±2%	100MHz	320mA	0.40ohm	40	150MHz	750MHz
LQW2BHNR12J03□	120nH±5%	100MHz	320mA	0.40ohm	40	150MHz	750MHz
LQW2BHNR15G03□	150nH±2%	100MHz	260mA	0.68ohm	30	150MHz	350MHz
LQW2BHNR15J03□	150nH±5%	100MHz	390mA	0.47ohm	30	150MHz	350MHz
LQW2BHNR18G03□	180nH±2%	100MHz	250mA	0.71ohm	35	100MHz	700MHz
LQW2BHNR18J03□	180nH±5%	100MHz	250mA	0.71ohm	35	100MHz	700MHz
LQW2BHNR22G03□	220nH±2%	100MHz	240mA	0.70ohm	35	100MHz	500MHz
LQW2BHNR22J03□	220nH±5%	100MHz	240mA	0.70ohm	35	100MHz	500MHz
LQW2BHNR27J03□	270nH±5%	10MHz	190mA	2.00ohm	15	25.2MHz	550MHz
LQW2BHNR27K03□	270nH±10%	10MHz	190mA	2.00ohm	15	25.2MHz	550MHz
LQW2BHNR33J03□	330nH±5%	10MHz	180mA	2.20ohm	15	25.2MHz	500MHz
LQW2BHNR33K03□	330nH±10%	10MHz	180mA	2.20ohm	15	25.2MHz	500MHz
LQW2BHNR39J03□	390nH±5%	10MHz	170mA	2.50ohm	15	25.2MHz	400MHz
LQW2BHNR39K03□	390nH±10%	10MHz	170mA	2.50ohm	15	25.2MHz	400MHz
LQW2BHNR47J03□	470nH±5%	10MHz	160mA	2.80ohm	15	25.2MHz	350MHz
LQW2BHNR47K03□	470nH±10%	10MHz	160mA	2.80ohm	15	25.2MHz	350MHz

Operating Temperature Range: -40°C to +85°C

LQW2BH_13 Series (High Q/Low DC Resistance Type)

■ Rated Value (□: packaging code)

Part Number	Inductance	Test Frequency	Rated Current	Max. of DC Resistance	Q (min.)	Test Frequency	Self Resonance Frequency (min.)
LQW2BHN2N7D13□	2.7nH±0.5nH	100MHz	1900mA	0.02ohm	20	250MHz	6000MHz
LQW2BHN3N1D13□	3.1nH±0.5nH	100MHz	1800mA	0.02ohm	20	250MHz	6000MHz
LQW2BHN3N3D13□	3.3nH±0.5nH	100MHz	1700mA	0.02ohm	20	250MHz	6000MHz
LQW2BHN5N6D13□	5.6nH±0.5nH	100MHz	1500mA	0.02ohm	35	250MHz	6000MHz
LQW2BHN6N8D13□	6.8nH±0.5nH	100MHz	1400mA	0.02ohm	35	250MHz	5400MHz
LQW2BHN8N6D13□	8.6nH±0.5nH	100MHz	1300mA	0.03ohm	35	250MHz	3900MHz
LQW2BHN10NJ13□	10nH±5%	100MHz	1320mA	0.03ohm	35	250MHz	3300MHz
LQW2BHN12NK13□	12nH±10%	100MHz	1100mA	0.04ohm	40	250MHz	3200MHz
LQW2BHN15NK13□	15nH±10%	100MHz	1000mA	0.04ohm	40	250MHz	3100MHz
LQW2BHN18NK13□	18.8nH±10%	100MHz	1000mA	0.05ohm	40	250MHz	2600MHz
LQW2BHN21NK13□	21nH±10%	100MHz	950mA	0.05ohm	40	250MHz	2200MHz
LQW2BHN27NK13□	27nH±10%	100MHz	900mA	0.06ohm	40	250MHz	1800MHz

Operating Temperature Range: -40°C to +85°C

Continued from the preceding page.

■ Q - Frequency Characteristics (Typ.)

LQW2BH_03

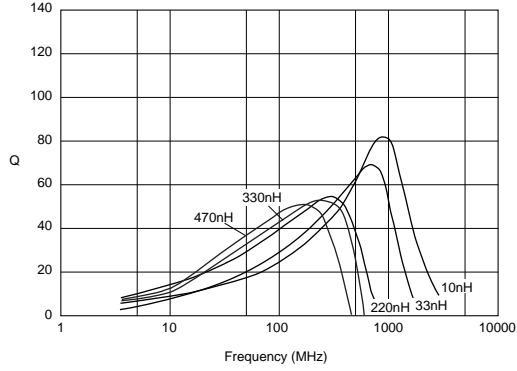

■ Inductance - Frequency Characteristics (Typ.)

LQW2BH_03

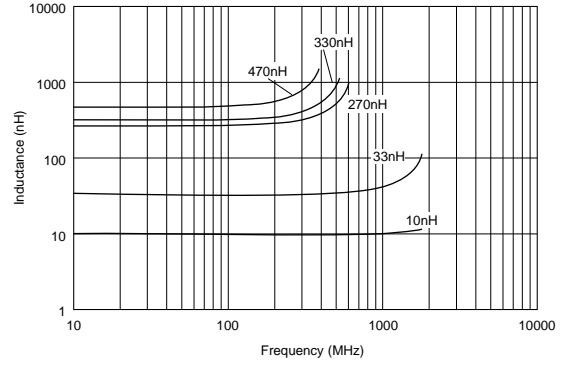

■ Q - Frequency Characteristics (Typ.)

LQW2BH_13

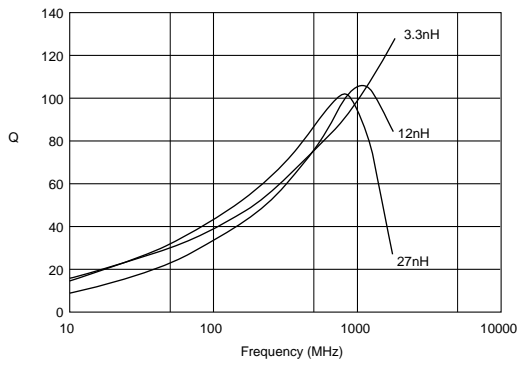

■ Inductance - Frequency Characteristics (Typ.)

LQW2BH_13

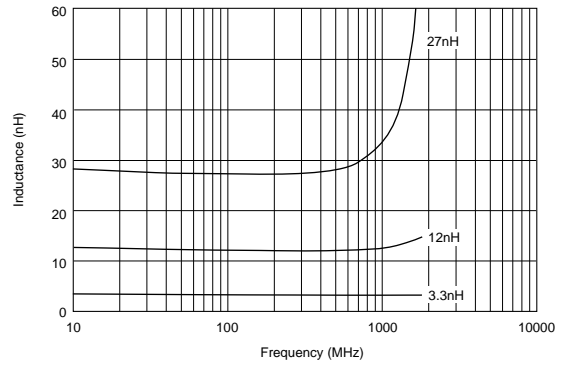

Chip Coils for High Frequency Vertical Wire Wound



LQW31H Series (1206 Size)

LQW31H series is alumina core type chip inductor for high frequency circuit. Its low dc resistance and high Q due to wire wound structure are suitable for handheld telecommunications equipment.

■ Features

1. Inductance range from 8.8 to 100nH.
2. Because of the high self-resonant frequency, it can be used in high frequency range.
3. Tight inductance tolerance (+/-5%)

■ Dimensions

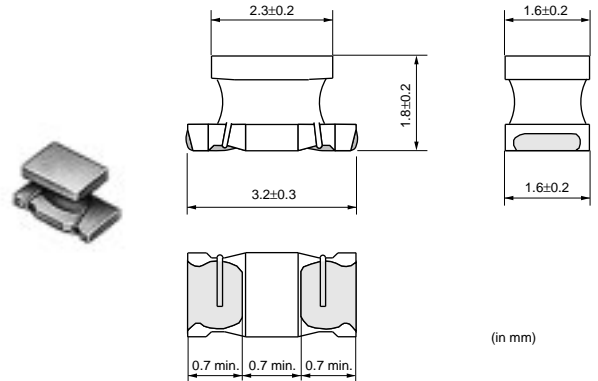

■ Rated Value (□: packaging code)

Part Number	Inductance	Test Frequency	Rated Current	DC Resistance	Q (min.)	Test Frequency	Self Resonance Frequency (min.)
LQW31HN8N8J03□	8.8nH±5%	100MHz	750mA	0.029ohm±40%	50	436MHz	1000MHz
LQW31HN8N8K03□	8.8nH±10%	100MHz	750mA	0.029ohm±40%	50	436MHz	1000MHz
LQW31HN15NJ03□	14.7nH±5%	100MHz	680mA	0.035ohm±40%	60	436MHz	1000MHz
LQW31HN15NK03□	14.7nH±10%	100MHz	680mA	0.035ohm±40%	60	436MHz	1000MHz
LQW31HN17NJ03□	17nH±5%	100MHz	650mA	0.037ohm±40%	60	436MHz	1000MHz
LQW31HN17NK03□	17nH±10%	100MHz	650mA	0.037ohm±40%	60	436MHz	1000MHz
LQW31HN23NJ03□	23nH±5%	100MHz	590mA	0.046ohm±40%	60	436MHz	1000MHz
LQW31HN23NK03□	23nH±10%	100MHz	590mA	0.046ohm±40%	60	436MHz	1000MHz
LQW31HN27NJ03□	27nH±5%	100MHz	560mA	0.051ohm±40%	60	436MHz	1000MHz
LQW31HN27NK03□	27nH±10%	100MHz	560mA	0.051ohm±40%	60	436MHz	1000MHz
LQW31HN33NJ03□	33nH±5%	100MHz	530mA	0.057ohm±40%	60	436MHz	1000MHz
LQW31HN33NK03□	33nH±10%	100MHz	530mA	0.057ohm±40%	60	436MHz	1000MHz
LQW31HN39NJ03□	39nH±5%	100MHz	490mA	0.067ohm±40%	60	436MHz	1000MHz
LQW31HN39NK03□	39nH±10%	100MHz	490mA	0.067ohm±40%	60	436MHz	1000MHz
LQW31HN47NJ03□	47nH±5%	100MHz	380mA	0.11ohm±40%	60	436MHz	1000MHz
LQW31HN47NK03□	47nH±10%	100MHz	380mA	0.11ohm±40%	60	436MHz	1000MHz
LQW31HN56NJ03□	56nH±5%	100MHz	330mA	0.14ohm±40%	60	436MHz	1000MHz
LQW31HN56NK03□	56nH±10%	100MHz	330mA	0.14ohm±40%	60	436MHz	1000MHz
LQW31HN64NJ03□	64nH±5%	100MHz	290mA	0.18ohm±40%	60	436MHz	1000MHz
LQW31HN64NK03□	64nH±10%	100MHz	290mA	0.18ohm±40%	60	436MHz	1000MHz
LQW31HN84NJ03□	84nH±5%	100MHz	240mA	0.28ohm±40%	60	436MHz	1000MHz
LQW31HN84NK03□	84nH±10%	100MHz	240mA	0.28ohm±40%	60	436MHz	1000MHz
LQW31HNR10J03□	100nH±5%	100MHz	230mA	0.3ohm±40%	60	436MHz	900MHz
LQW31HNR10K03□	100nH±10%	100MHz	230mA	0.3ohm±40%	60	436MHz	900MHz

Operating Temperature Range: -40°C to +85°C

■ Q - Frequency Characteristics (Typ.)

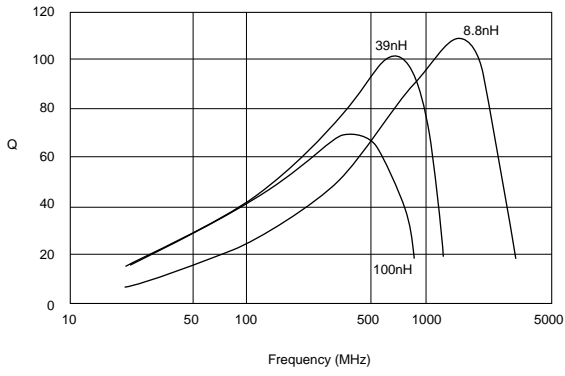

Chip Coils for High Frequency Horizontal Wire Wound Ferrite Type



LQW21H_00 Series (0805 Size)

LQW21H Series is wire-wound chip inductor which is based on Murata's original ferrite core and precise wound technology. The use of a high frequency ferrite core as winding bobbin enables small size, but high inductance (micro H order) and high Q at FM band.

■ Features

1. High inductance (0.47 to 2.2 micro H) for FM band
2. High Q value
3. Smaller size and higher performance than 2.5x2.0mm air core inductor contributes to the design of smaller or thinner equipment.

■ Applications

1. TV tuner circuits of mobile phones
2. FM Transmitter circuits
3. Matching applications of FM band

■ Dimensions

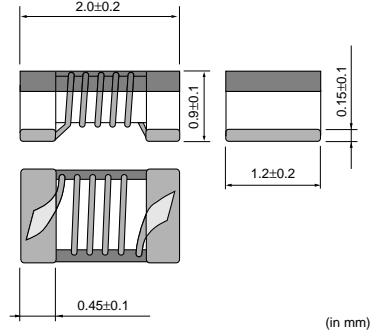

5

■ Rated Value (□: packaging code)

Part Number	Inductance	Test Frequency	Rated Current	Max. of DC Resistance	Q (min.)	Test Frequency	Self Resonance Frequency (min.)
LQW21HNR47J00□	0.47μH±5%	10MHz	160mA	1.30ohm	35	100MHz	620MHz
LQW21HNR56J00□	0.56μH±5%	10MHz	150mA	1.43ohm	35	100MHz	580MHz
LQW21HNR68J00□	0.68μH±5%	10MHz	130mA	2.21ohm	35	100MHz	520MHz
LQW21HNR82J00□	0.82μH±5%	10MHz	125mA	2.34ohm	35	100MHz	480MHz
LQW21HN1R0J00□	1.0μH±5%	10MHz	115mA	2.86ohm	35	100MHz	450MHz
LQW21HN1R2J00□	1.2μH±5%	10MHz	100mA	3.12ohm	35	100MHz	400MHz
LQW21HN1R5J00□	1.5μH±5%	10MHz	85mA	5.33ohm	35	100MHz	350MHz
LQW21HN1R8J00□	1.8μH±5%	10MHz	80mA	5.85ohm	35	100MHz	320MHz
LQW21HN2R2J00□	2.2μH±5%	10MHz	75mA	6.50ohm	35	100MHz	300MHz

Operating Temperature Range: -40°C to +85°C Only for reflow soldering.

■ Q - Frequency Characteristics (Typ.)

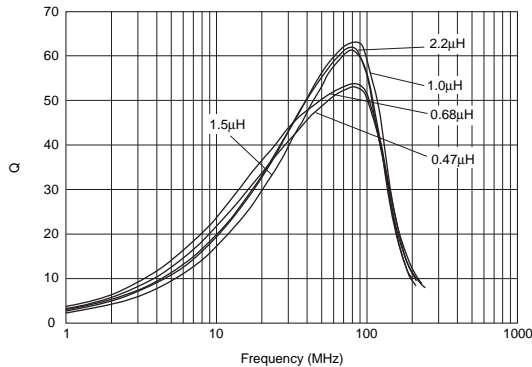

■ Inductance - Frequency Characteristics (Typ.)

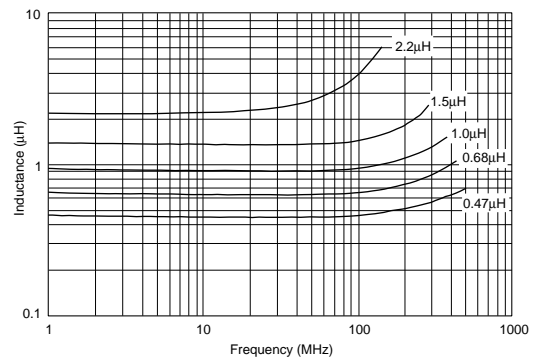

Chip Coils for High Frequency Wire Wound Ferrite Type



LQH31H Series (1206 Size)

LQH31H series is wire wound type chip coil with ferrite core for high frequency.

■ Dimensions

■ Features

1. Inductance range from 54 to 880nH
2. High Q value and stable inductance in high frequency range from 30 to 150MHz
3. Applicable soldering methods are both flow soldering and reflow soldering.

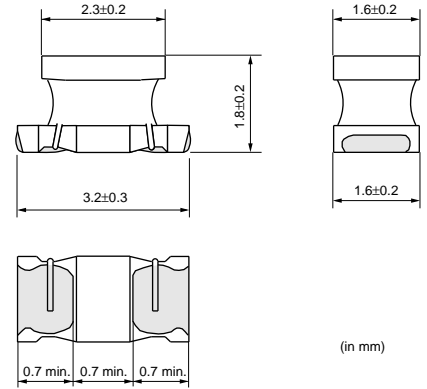

■ Rated Value (□: packaging code)

Part Number	Inductance	Test Frequency	Rated Current	DC Resistance	Q (min.)	Test Frequency	Self Resonance Frequency (min.)
LQH31HN54NK03□	54nH±10%	1MHz	920mA	0.035ohm±30%	50	100MHz	800MHz
LQH31HN95NK03□	95nH±10%	1MHz	790mA	0.047ohm±30%	60	100MHz	650MHz
LQH31HNR14J03□	145nH±5%	1MHz	700mA	0.061ohm±30%	60	100MHz	500MHz
LQH31HNR14K03□	145nH±10%	1MHz	700mA	0.061ohm±30%	60	100MHz	500MHz
LQH31HNR21J03□	215nH±5%	1MHz	520mA	0.11ohm±30%	60	100MHz	430MHz
LQH31HNR21K03□	215nH±10%	1MHz	520mA	0.11ohm±30%	60	100MHz	430MHz
LQH31HNR29J03□	290nH±5%	1MHz	420mA	0.17ohm±30%	60	100MHz	360MHz
LQH31HNR29K03□	290nH±10%	1MHz	420mA	0.17ohm±30%	60	100MHz	360MHz
LQH31HNR39J03□	390nH±5%	1MHz	330mA	0.26ohm±30%	60	100MHz	300MHz
LQH31HNR39K03□	390nH±10%	1MHz	330mA	0.26ohm±30%	60	100MHz	300MHz
LQH31HNR50J03□	500nH±5%	1MHz	260mA	0.44ohm±30%	60	100MHz	270MHz
LQH31HNR50K03□	500nH±10%	1MHz	260mA	0.44ohm±30%	60	100MHz	270MHz
LQH31HNR61J03□	610nH±5%	1MHz	250mA	0.48ohm±30%	60	100MHz	240MHz
LQH31HNR61K03□	610nH±10%	1MHz	250mA	0.48ohm±30%	60	100MHz	240MHz
LQH31HNR75J03□	750nH±5%	1MHz	190mA	0.79ohm±30%	60	100MHz	220MHz
LQH31HNR75K03□	750nH±10%	1MHz	190mA	0.79ohm±30%	60	100MHz	220MHz
LQH31HNR88J03□	880nH±5%	1MHz	180mA	0.86ohm±30%	60	100MHz	200MHz
LQH31HNR88K03□	880nH±10%	1MHz	180mA	0.86ohm±30%	60	100MHz	200MHz

Operating Temperature Range: -40°C to +85°C

■ Q - Frequency Characteristics (Typ.)

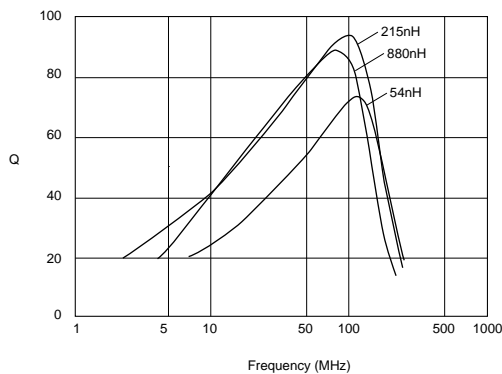

Chip Coils for General Use Monolithic Type



LQM18N Series (0603 Size)

LQM18N series consisting of magnetically shielded chip coils was developed by using original multilayer process technology and magnetic materials. Compact size is suitable for high density mounting. Shielded construction is not affected by interference from peripheral components.

■ Features

1. Magnetically shielded structure provides excellent characteristics in crosstalk and magnetic coupling.
2. Compact size (1.6x0.8mm) and lightweight
3. The external electrodes with nickel barrier structure provide excellent solder heat resistance. Applicable soldering methods are both flow soldering and reflow soldering.

■ Dimensions

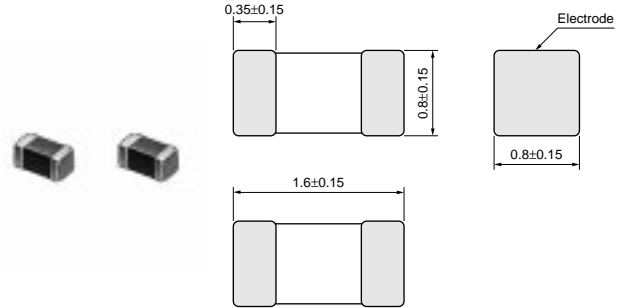

(in mm)

■ Applications

1. Resonance circuit, traps, filter circuits
2. RF choke in telecommunications equipment, cordless phones, radio equipment

■ Rated Value (□: packaging code)

Part Number	Inductance	Test Frequency	Rated Current	Max. of DC Resistance	Q (min.)	Test Frequency	Self Resonance Frequency (min.)
LQM18NN47NM00□	47nH±20%	50MHz	50mA	0.30ohm	10	50MHz	260MHz
LQM18NN68NM00□	68nH±20%	50MHz	50mA	0.30ohm	10	50MHz	250MHz
LQM18NN82NM00□	82nH±20%	50MHz	50mA	0.30ohm	10	50MHz	245MHz
LQM18NNR10K00□	100nH±10%	25MHz	50mA	0.50ohm	15	25MHz	240MHz
LQM18NNR12K00□	120nH±10%	25MHz	50mA	0.50ohm	15	25MHz	205MHz
LQM18NNR15K00□	150nH±10%	25MHz	50mA	0.60ohm	15	25MHz	180MHz
LQM18NNR18K00□	180nH±10%	25MHz	50mA	0.60ohm	15	25MHz	165MHz
LQM18NNR22K00□	220nH±10%	25MHz	50mA	0.80ohm	15	25MHz	150MHz
LQM18NNR27K00□	270nH±10%	25MHz	50mA	0.80ohm	15	25MHz	136MHz
LQM18NNR33K00□	330nH±10%	25MHz	35mA	0.85ohm	15	25MHz	125MHz
LQM18NNR39K00□	390nH±10%	25MHz	35mA	1.00ohm	15	25MHz	110MHz
LQM18NNR47K00□	470nH±10%	25MHz	35mA	1.35ohm	15	25MHz	105MHz
LQM18NNR56K00□	560nH±10%	25MHz	35mA	1.55ohm	15	25MHz	95MHz
LQM18NNR68K00□	680nH±10%	25MHz	35mA	1.70ohm	15	25MHz	90MHz
LQM18NNR82K00□	820nH±10%	25MHz	35mA	2.10ohm	15	25MHz	85MHz
LQM18NN1R0K00□	1000nH±10%	10MHz	25mA	0.60ohm	35	10MHz	75MHz
LQM18NN1R2K00□	1200nH±10%	10MHz	25mA	0.80ohm	35	10MHz	65MHz
LQM18NN1R5K00□	1500nH±10%	10MHz	25mA	0.80ohm	35	10MHz	60MHz
LQM18NN1R8K00□	1800nH±10%	10MHz	25mA	0.95ohm	35	10MHz	55MHz
LQM18NN2R2K00□	2200nH±10%	10MHz	15mA	1.15ohm	35	10MHz	50MHz

Operating Temperature Range: -40°C to +85°C

■ Q - Frequency Characteristics (Typ.)

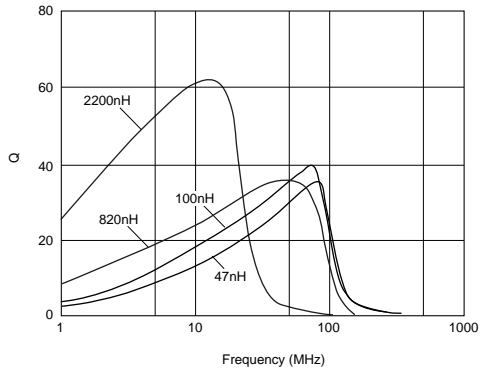

■ Inductance - Frequency Characteristics (Typ.)

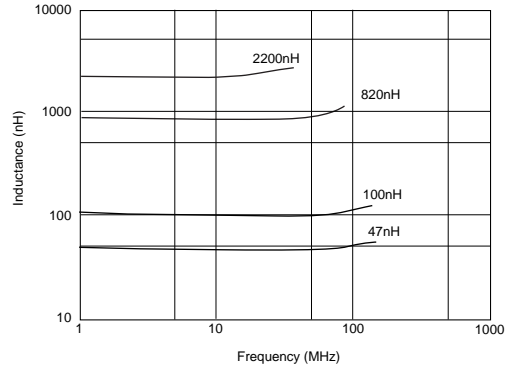

Chip Coils for General Use Monolithic Type



LQM21N Series (0805 Size)

■ Features

LQM21N series consists of magnetically shielded chip inductors developed using Murata's original multilayer process technology and magnetic materials. The miniature size of 2.0x1.25mm enables compact design of electric equipment. Inductance range from 0.1 micro H to 4.7 micro H is available.

■ Dimensions

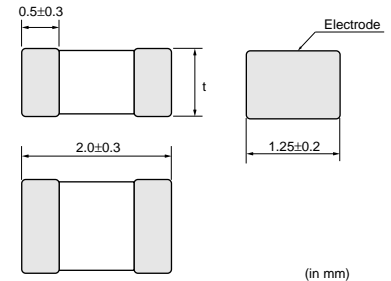

Dimension of t	Inductance: 0.1 to 2.2μH	0.85±0.2
	Inductance: 2.7 to 4.7μH	1.25±0.2

■ Rated Value (□: packaging code)

Part Number	Inductance	Test Frequency	Rated Current	Max. of DC Resistance	Q (min.)	Test Frequency	Self Resonance Frequency (min.)
LQM21NNR10K10□	0.1μH±10%	25MHz	250mA	0.26ohm	20	25MHz	340MHz
LQM21NNR12K10□	0.12μH±10%	25MHz	250mA	0.29ohm	20	25MHz	310MHz
LQM21NNR15K10□	0.15μH±10%	25MHz	250mA	0.32ohm	20	25MHz	270MHz
LQM21NNR18K10□	0.18μH±10%	25MHz	250mA	0.35ohm	20	25MHz	250MHz
LQM21NNR22K10□	0.22μH±10%	25MHz	250mA	0.38ohm	20	25MHz	220MHz
LQM21NNR27K10□	0.27μH±10%	25MHz	250mA	0.42ohm	20	25MHz	200MHz
LQM21NNR33K10□	0.33μH±10%	25MHz	250mA	0.48ohm	20	25MHz	180MHz
LQM21NNR39K10□	0.39μH±10%	25MHz	200mA	0.53ohm	25	25MHz	165MHz
LQM21NNR47K10□	0.47μH±10%	25MHz	200mA	0.57ohm	25	25MHz	150MHz
LQM21NNR56K10□	0.56μH±10%	25MHz	150mA	0.63ohm	25	25MHz	140MHz
LQM21NNR68K10□	0.68μH±10%	25MHz	150mA	0.72ohm	25	25MHz	125MHz
LQM21NNR82K10□	0.82μH±10%	25MHz	150mA	0.81ohm	25	25MHz	115MHz
LQM21NN1R0K10□	1μH±10%	10MHz	50mA	0.40ohm	45	10MHz	107MHz
LQM21NN1R2K10□	1.2μH±10%	10MHz	50mA	0.47ohm	45	10MHz	97MHz
LQM21NN1R5K10□	1.5μH±10%	10MHz	50mA	0.50ohm	45	10MHz	87MHz
LQM21NN1R8K10□	1.8μH±10%	10MHz	50mA	0.57ohm	45	10MHz	80MHz
LQM21NN2R2K10□	2.2μH±10%	10MHz	30mA	0.63ohm	45	10MHz	71MHz
LQM21NN2R7K10□	2.7μH±10%	10MHz	30mA	0.69ohm	45	10MHz	66MHz
LQM21NN3R3K10□	3.3μH±10%	10MHz	30mA	0.80ohm	45	10MHz	59MHz
LQM21NN3R9K10□	3.9μH±10%	10MHz	30mA	0.89ohm	45	10MHz	53MHz
LQM21NN4R7K10□	4.7μH±10%	10MHz	30mA	1.00ohm	45	10MHz	47MHz

Operating Temperature Range: -40°C to +85°C

■ Q - Frequency Characteristics (Typ.)

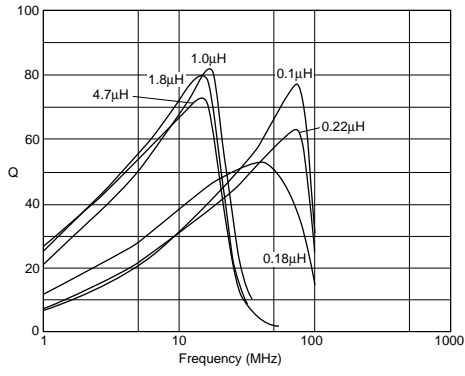

■ Inductance - Current Characteristics (Typ.)

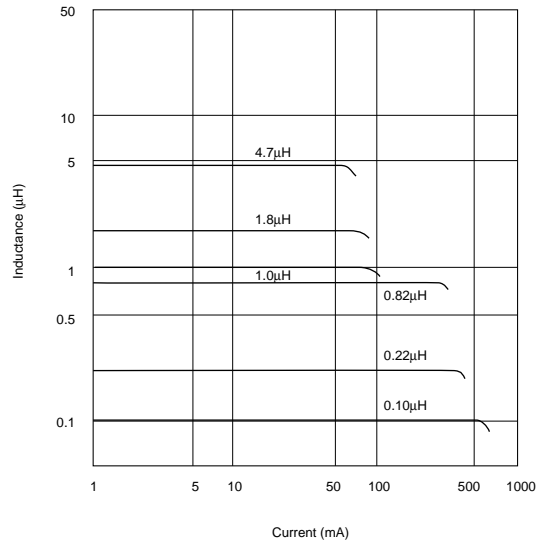

Chip Coils for General Use Wire Wound Type



LQH31M Series (1206 Size)

LQH31M series consists of wire wound type chip coils using Murata's original ferrite core and automatic wire wound technology.

■ Features

1. Wide inductance range from 0.15 to 100 micro H
2. High Q value at high frequencies and low DC resistance
3. Small size (3.2x1.6x1.8mm) and tight pitch mounting
4. Low DC resistance and large current
5. Both flow and reflow soldering heat resistance

■ Dimensions

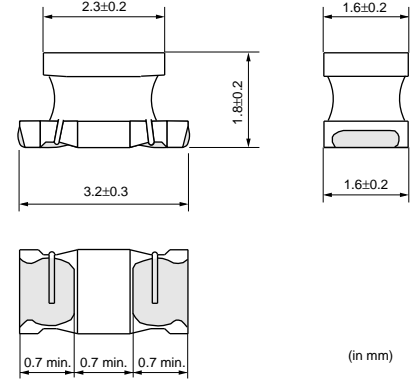

■ Rated Value (□: packaging code)

Part Number	Inductance	Test Frequency	Rated Current	DC Resistance	Q (min.)	Test Frequency	Self Resonance Frequency (min.)
LQH31MNR15K03□	0.15μH±10%	1MHz	250mA	0.39ohm±40%	20	25MHz	250MHz
LQH31MNR22K03□	0.22μH±10%	1MHz	240mA	0.43ohm±40%	20	25MHz	250MHz
LQH31MNR33K03□	0.33μH±10%	1MHz	230mA	0.45ohm±40%	30	25MHz	250MHz
LQH31MNR47K03□	0.47μH±10%	1MHz	215mA	0.83ohm±40%	30	25MHz	200MHz
LQH31MNR56K03□	0.56μH±10%	1MHz	200mA	0.61ohm±40%	30	25MHz	180MHz
LQH31MNR68K03□	0.68μH±10%	1MHz	190mA	0.67ohm±40%	30	25MHz	160MHz
LQH31MNR82K03□	0.82μH±10%	1MHz	185mA	0.73ohm±40%	30	25MHz	120MHz
LQH31MN1R0K03□	1.0μH±10%	1MHz	175mA	0.49ohm±30%	35	10MHz	100MHz
LQH31MN1R2J03□	1.2μH±5%	1MHz	165mA	0.37ohm±30%	35	10MHz	90MHz
LQH31MN1R2K03□	1.2μH±10%	1MHz	165mA	0.9ohm±30%	35	10MHz	90MHz
LQH31MN1R5J03□	1.5μH±5%	1MHz	155mA	1.0ohm±30%	35	10MHz	75MHz
LQH31MN1R5K03□	1.5μH±10%	1MHz	155mA	1.0ohm±30%	35	10MHz	75MHz
LQH31MN1R8J03□	1.8μH±5%	1MHz	150mA	1.6ohm±30%	35	10MHz	60MHz
LQH31MN1R8K03□	1.8μH±10%	1MHz	150mA	1.6ohm±30%	35	10MHz	60MHz
LQH31MN2R2J03□	2.2μH±5%	1MHz	140mA	0.7ohm±30%	35	10MHz	50MHz
LQH31MN2R2K03□	2.2μH±10%	1MHz	140mA	0.7ohm±30%	35	10MHz	50MHz
LQH31MN2R7J03□	2.7μH±5%	1MHz	135mA	0.55ohm±30%	35	10MHz	43MHz
LQH31MN2R7K03□	2.7μH±10%	1MHz	135mA	0.55ohm±30%	35	10MHz	43MHz
LQH31MN3R3J03□	3.3μH±5%	1MHz	130mA	0.61ohm±30%	35	8MHz	38MHz
LQH31MN3R3K03□	3.3μH±10%	1MHz	130mA	0.61ohm±30%	35	8MHz	38MHz
LQH31MN3R9J03□	3.9μH±5%	1MHz	125mA	1.5ohm±30%	35	8MHz	35MHz
LQH31MN3R9K03□	3.9μH±10%	1MHz	125mA	1.5ohm±30%	35	8MHz	35MHz
LQH31MN4R7J03□	4.7μH±5%	1MHz	120mA	1.7ohm±30%	35	8MHz	31MHz
LQH31MN4R7K03□	4.7μH±10%	1MHz	120mA	1.7ohm±30%	35	8MHz	31MHz
LQH31MN5R6J03□	5.6μH±5%	1MHz	115mA	1.8ohm±30%	35	8MHz	28MHz
LQH31MN5R6K03□	5.6μH±10%	1MHz	115mA	1.8ohm±30%	35	8MHz	28MHz
LQH31MN6R8J03□	6.8μH±5%	1MHz	110mA	2.0ohm±30%	35	8MHz	25MHz
LQH31MN6R8K03□	6.8μH±10%	1MHz	110mA	2.0ohm±30%	35	8MHz	25MHz
LQH31MN8R2J03□	8.2μH±5%	1MHz	105mA	2.2ohm±30%	35	8MHz	23MHz
LQH31MN8R2K03□	8.2μH±10%	1MHz	105mA	2.2ohm±30%	35	8MHz	23MHz
LQH31MN100J03□	10μH±5%	1MHz	100mA	2.5ohm±30%	35	5MHz	20MHz

Operating Temperature Range: -40°C to +85°C

Continued on the following page.

Continued from the preceding page.

Part Number	Inductance	Test Frequency	Rated Current	DC Resistance	Q (min.)	Test Frequency	Self Resonance Frequency (min.)
LQH31MN100K03□	10μH±10%	1MHz	100mA	2.5ohm±30%	35	5MHz	20MHz
LQH31MN120J03□	12μH±5%	1MHz	95mA	2.7ohm±30%	35	5MHz	18MHz
LQH31MN120K03□	12μH±10%	1MHz	95mA	2.7ohm±30%	35	5MHz	18MHz
LQH31MN150J03□	15μH±5%	1MHz	90mA	3.0ohm±30%	35	5MHz	16MHz
LQH31MN150K03□	15μH±10%	1MHz	90mA	3.0ohm±30%	35	5MHz	16MHz
LQH31MN180J03□	18μH±5%	1MHz	85mA	3.4ohm±30%	35	5MHz	15MHz
LQH31MN180K03□	18μH±10%	1MHz	85mA	3.4ohm±30%	35	5MHz	15MHz
LQH31MN220J03□	22μH±5%	1MHz	85mA	3.1ohm±30%	40	2.5MHz	14MHz
LQH31MN220K03□	22μH±10%	1MHz	85mA	3.1ohm±30%	40	2.5MHz	14MHz
LQH31MN270J03□	27μH±5%	1MHz	85mA	3.4ohm±30%	40	2.5MHz	13MHz
LQH31MN270K03□	27μH±10%	1MHz	85mA	3.4ohm±30%	40	2.5MHz	13MHz
LQH31MN330J03□	33μH±5%	1MHz	80mA	3.8ohm±30%	40	2.5MHz	12MHz
LQH31MN330K03□	33μH±10%	1MHz	80mA	3.8ohm±30%	40	2.5MHz	12MHz
LQH31MN390J03□	39μH±5%	1MHz	55mA	7.2ohm±30%	40	2.5MHz	11MHz
LQH31MN390K03□	39μH±10%	1MHz	55mA	7.2ohm±30%	40	2.5MHz	11MHz
LQH31MN470J03□	47μH±5%	1MHz	55mA	8.0ohm±30%	40	2.5MHz	10MHz
LQH31MN470K03□	47μH±10%	1MHz	55mA	8.0ohm±30%	40	2.5MHz	10MHz
LQH31MN560J03□	56μH±5%	1MHz	50mA	8.9ohm±30%	40	2.5MHz	9MHz
LQH31MN560K03□	56μH±10%	1MHz	50mA	8.9ohm±30%	40	2.5MHz	9MHz
LQH31MN680J03□	68μH±5%	1MHz	50mA	9.9ohm±30%	40	2.5MHz	8.5MHz
LQH31MN680K03□	68μH±10%	1MHz	50mA	9.9ohm±30%	40	2.5MHz	8.5MHz
LQH31MN820J03□	82μH±5%	1MHz	45mA	11ohm±30%	40	2.5MHz	7.5MHz
LQH31MN820K03□	82μH±10%	1MHz	45mA	11ohm±30%	40	2.5MHz	7.5MHz
LQH31MN101J03□	100μH±5%	1MHz	45mA	12ohm±30%	40	2.5MHz	7MHz
LQH31MN101K03□	100μH±10%	1MHz	45mA	12ohm±30%	40	2.5MHz	7MHz

Operating Temperature Range: -40°C to +85°C

Q - Frequency Characteristics (Typ.)

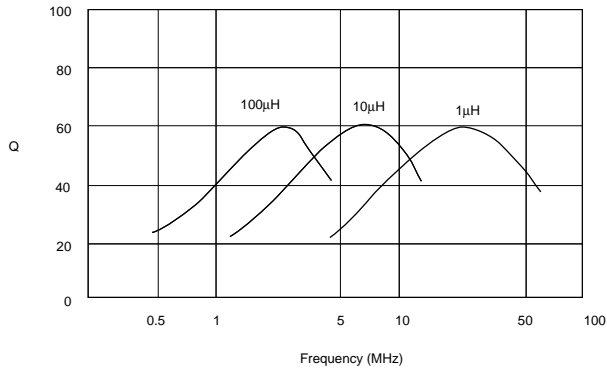

Inductance - Current Characteristics (Typ.)

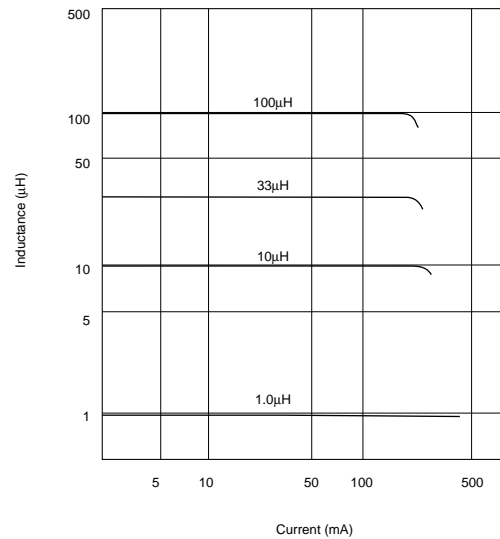

Coupling Coefficient

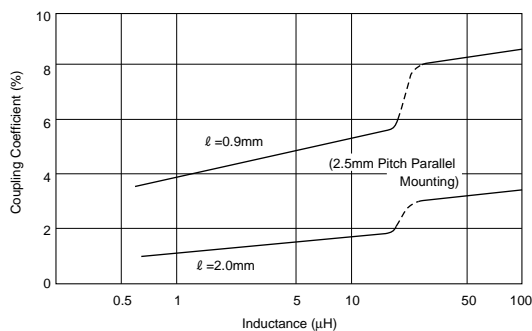

Chip Coils for General Use Wire Wound Type



LQH32M Series (1210 Size)

LQH32M series consists of miniature chip inductors wire wound on a special ferrite core.

■ Features

1. High Q value at high frequencies and low DC resistance
2. Wide inductance range from 1.0 to 560 micro H

■ Dimensions

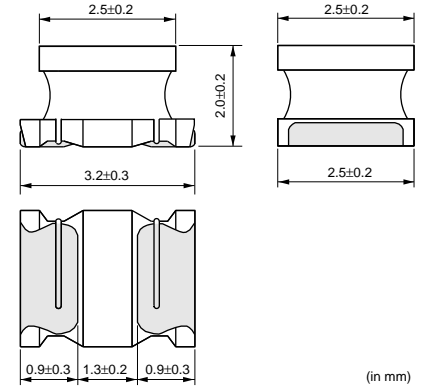

(in mm)

■ Rated Value (□: packaging code)

Part Number	Inductance	Test Frequency	Rated Current	Max. of DC Resistance	Q (min.)	Test Frequency	Self Resonance Frequency (min.)
LQH32MN1R0M23□	1.0μH±20%	1MHz	445mA	0.5ohm	20	1MHz	100MHz
LQH32MN1R2M23□	1.2μH±20%	1MHz	425mA	0.6ohm	20	1MHz	100MHz
LQH32MN1R5K23□	1.5μH±10%	1MHz	400mA	0.6ohm	20	1MHz	75MHz
LQH32MN1R8K23□	1.8μH±10%	1MHz	390mA	0.7ohm	20	1MHz	60MHz
LQH32MN2R2K23□	2.2μH±10%	1MHz	370mA	0.8ohm	20	1MHz	50MHz
LQH32MN2R7K23□	2.7μH±10%	1MHz	320mA	0.9ohm	20	1MHz	43MHz
LQH32MN3R3K23□	3.3μH±10%	1MHz	300mA	1.0ohm	20	1MHz	38MHz
LQH32MN3R9K23□	3.9μH±10%	1MHz	290mA	1.1ohm	20	1MHz	35MHz
LQH32MN4R7K23□	4.7μH±10%	1MHz	270mA	1.2ohm	20	1MHz	31MHz
LQH32MN5R6K23□	5.6μH±10%	1MHz	250mA	1.3ohm	20	1MHz	28MHz
LQH32MN6R8K23□	6.8μH±10%	1MHz	240mA	1.5ohm	20	1MHz	25MHz
LQH32MN8R2K23□	8.2μH±10%	1MHz	225mA	1.6ohm	20	1MHz	23MHz
LQH32MN100J23□	10μH±5%	1MHz	190mA	1.8ohm	35	1MHz	20MHz
LQH32MN100K23□	10μH±10%	1MHz	190mA	1.8ohm	35	1MHz	20MHz
LQH32MN120J23□	12μH±5%	1MHz	180mA	2.0ohm	35	1MHz	18MHz
LQH32MN120K23□	12μH±10%	1MHz	180mA	2.0ohm	35	1MHz	18MHz
LQH32MN150J23□	15μH±5%	1MHz	170mA	2.2ohm	35	1MHz	16MHz
LQH32MN150K23□	15μH±10%	1MHz	170mA	2.2ohm	35	1MHz	16MHz
LQH32MN180J23□	18μH±5%	1MHz	165mA	2.5ohm	35	1MHz	15MHz
LQH32MN180K23□	18μH±10%	1MHz	165mA	2.5ohm	35	1MHz	15MHz
LQH32MN220J23□	22μH±5%	1MHz	150mA	2.8ohm	35	1MHz	14MHz
LQH32MN220K23□	22μH±10%	1MHz	150mA	2.8ohm	35	1MHz	14MHz
LQH32MN270J23□	27μH±5%	1MHz	125mA	3.1ohm	35	1MHz	13MHz
LQH32MN270K23□	27μH±10%	1MHz	125mA	3.1ohm	35	1MHz	13MHz
LQH32MN330J23□	33μH±5%	1MHz	115mA	3.5ohm	40	1MHz	12MHz
LQH32MN330K23□	33μH±10%	1MHz	115mA	3.5ohm	40	1MHz	12MHz
LQH32MN390J23□	39μH±5%	1MHz	110mA	3.9ohm	40	1MHz	11MHz
LQH32MN390K23□	39μH±10%	1MHz	110mA	3.9ohm	40	1MHz	11MHz
LQH32MN470J23□	47μH±5%	1MHz	100mA	4.3ohm	40	1MHz	11MHz
LQH32MN470K23□	47μH±10%	1MHz	100mA	4.3ohm	40	1MHz	11MHz
LQH32MN560J23□	56μH±5%	1MHz	85mA	4.9ohm	40	1MHz	10MHz

Operating Temperature Range: -40°C to +85°C

Continued on the following page.

Continued from the preceding page.

Part Number	Inductance	Test Frequency	Rated Current	Max. of DC Resistance	Q (min.)	Test Frequency	Self Resonance Frequency (min.)
LQH32MN560K23□	56μH±10%	1MHz	85mA	4.9ohm	40	1MHz	10MHz
LQH32MN680J23□	68μH±5%	1MHz	80mA	5.5ohm	40	1MHz	9MHz
LQH32MN680K23□	68μH±10%	1MHz	80mA	5.5ohm	40	1MHz	9MHz
LQH32MN820J23□	82μH±5%	1MHz	70mA	6.2ohm	40	1MHz	8.5MHz
LQH32MN820K23□	82μH±10%	1MHz	70mA	6.2ohm	40	1MHz	8.5MHz
LQH32MN101J23□	100μH±5%	1MHz	80mA	7.0ohm	40	796kHz	8MHz
LQH32MN101K23□	100μH±10%	1MHz	80mA	7.0ohm	40	796kHz	8MHz
LQH32MN121J23□	120μH±5%	1MHz	75mA	8.0ohm	40	796kHz	7.5MHz
LQH32MN121K23□	120μH±10%	1MHz	75mA	8.0ohm	40	796kHz	7.5MHz
LQH32MN151J23□	150μH±5%	1MHz	70mA	9.3ohm	40	796kHz	7MHz
LQH32MN151K23□	150μH±10%	1MHz	70mA	9.3ohm	40	796kHz	7MHz
LQH32MN181J23□	180μH±5%	1MHz	65mA	10.2ohm	40	796kHz	6MHz
LQH32MN181K23□	180μH±10%	1MHz	65mA	10.2ohm	40	796kHz	6MHz
LQH32MN221J23□	220μH±5%	1MHz	65mA	11.8ohm	40	796kHz	5.5MHz
LQH32MN221K23□	220μH±10%	1MHz	65mA	11.8ohm	40	796kHz	5.5MHz
LQH32MN271J23□	270μH±5%	1MHz	65mA	12.5ohm	40	796kHz	5MHz
LQH32MN271K23□	270μH±10%	1MHz	65mA	12.5ohm	40	796kHz	5MHz
LQH32MN331J23□	330μH±5%	1MHz	65mA	13.0ohm	40	796kHz	5MHz
LQH32MN331K23□	330μH±10%	1MHz	65mA	13.0ohm	40	796kHz	5MHz
LQH32MN391J23□	390μH±5%	1MHz	50mA	22.0ohm	50	796kHz	5MHz
LQH32MN391K23□	390μH±10%	1MHz	50mA	22.0ohm	50	796kHz	5MHz
LQH32MN471J23□	470μH±5%	1kHz	45mA	25.0ohm	50	796kHz	5MHz
LQH32MN471K23□	470μH±10%	1kHz	45mA	25.0ohm	50	796kHz	5MHz
LQH32MN561J23□	560μH±5%	1kHz	40mA	28.0ohm	50	796kHz	5MHz
LQH32MN561K23□	560μH±10%	1kHz	40mA	28.0ohm	50	796kHz	5MHz

Operating Temperature Range: -40°C to +85°C

■ Q - Frequency Characteristics (Typ.)

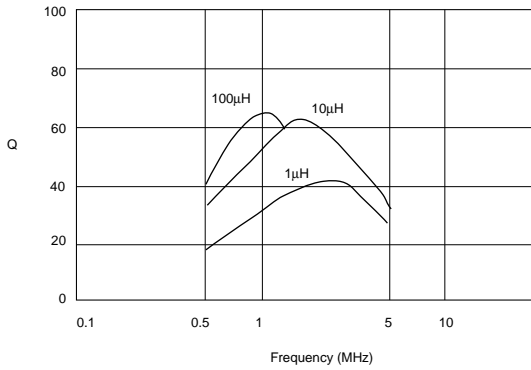

■ Inductance - Current Characteristics (Typ.)

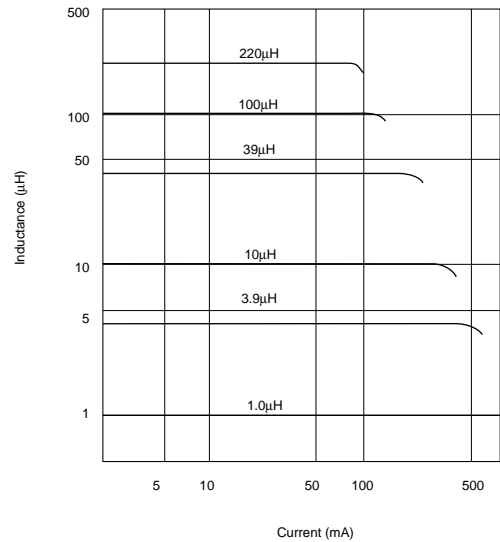

Chip Coils for General Use Wire Wound Type



LQH43M/LQH43N Series (1812 Size)

LQH43M/N series consists of wire wound type chip coils for general use by Murata's original automatic wire wound technology and ferrite core.

■ Features

1. High Q value at high frequency and low DC resistance
2. Wide inductance range from 1.0 to 2200 micro H
3. Large current and large inductance

■ Dimensions

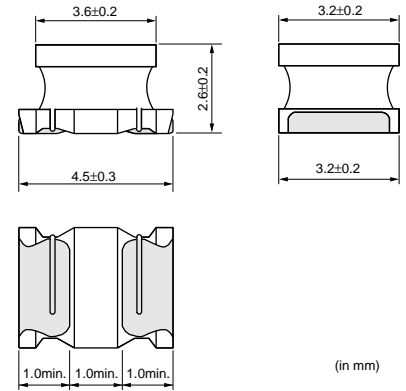

■ Rated Value (□: packaging code)

Part Number	Inductance	Test Frequency	Rated Current	Max. of DC Resistance	Q (min.)	Test Frequency	Self Resonance Frequency (min.)
LQH43MN1R0M03□	1.0μH±20%	1MHz	500mA	0.20ohm	20	1MHz	120MHz
LQH43MN1R2M03□	1.2μH±20%	1MHz	500mA	0.20ohm	20	1MHz	100MHz
LQH43MN1R5M03□	1.5μH±20%	1MHz	500mA	0.30ohm	20	1MHz	85MHz
LQH43MN1R8M03□	1.8μH±20%	1MHz	500mA	0.30ohm	20	1MHz	75MHz
LQH43MN2R2M03□	2.2μH±20%	1MHz	500mA	0.30ohm	20	1MHz	62MHz
LQH43MN2R7M03□	2.7μH±20%	1MHz	500mA	0.32ohm	20	1MHz	53MHz
LQH43MN3R3M03□	3.3μH±20%	1MHz	500mA	0.35ohm	20	1MHz	47MHz
LQH43MN3R9M03□	3.9μH±20%	1MHz	500mA	0.38ohm	20	1MHz	41MHz
LQH43MN4R7K03□	4.7μH±10%	1MHz	500mA	0.40ohm	30	1MHz	38MHz
LQH43MN5R6K03□	5.6μH±10%	1MHz	500mA	0.47ohm	30	1MHz	33MHz
LQH43MN6R8K03□	6.8μH±10%	1MHz	450mA	0.50ohm	30	1MHz	31MHz
LQH43MN8R2K03□	8.2μH±10%	1MHz	450mA	0.56ohm	30	1MHz	27MHz
LQH43MN100J03□	10μH±5%	1MHz	400mA	0.56ohm	35	1MHz	23MHz
LQH43MN100K03□	10μH±10%	1MHz	400mA	0.56ohm	35	1MHz	23MHz
LQH43MN120J03□	12μH±5%	1MHz	380mA	0.62ohm	35	1MHz	21MHz
LQH43MN120K03□	12μH±10%	1MHz	380mA	0.62ohm	35	1MHz	21MHz
LQH43MN150J03□	15μH±5%	1MHz	360mA	0.73ohm	35	1MHz	19MHz
LQH43MN150K03□	15μH±10%	1MHz	360mA	0.73ohm	35	1MHz	19MHz
LQH43MN180J03□	18μH±5%	1MHz	340mA	0.82ohm	35	1MHz	17MHz
LQH43MN180K03□	18μH±10%	1MHz	340mA	0.82ohm	35	1MHz	17MHz
LQH43MN220J03□	22μH±5%	1MHz	320mA	0.94ohm	35	1MHz	15MHz
LQH43MN220K03□	22μH±10%	1MHz	320mA	0.94ohm	35	1MHz	15MHz
LQH43MN270J03□	27μH±5%	1MHz	300mA	1.1ohm	35	1MHz	14MHz
LQH43MN270K03□	27μH±10%	1MHz	300mA	1.1ohm	35	1MHz	14MHz
LQH43MN330J03□	33μH±5%	1MHz	270mA	1.2ohm	35	1MHz	12MHz
LQH43MN330K03□	33μH±10%	1MHz	270mA	1.2ohm	35	1MHz	12MHz
LQH43MN390J03□	39μH±5%	1MHz	240mA	1.4ohm	35	1MHz	11MHz
LQH43MN390K03□	39μH±10%	1MHz	240mA	1.4ohm	35	1MHz	11MHz
LQH43MN470J03□	47μH±5%	1MHz	220mA	1.5ohm	35	1MHz	10MHz
LQH43MN470K03□	47μH±10%	1MHz	220mA	1.5ohm	35	1MHz	10MHz
LQH43MN560J03□	56μH±5%	1MHz	200mA	1.7ohm	35	1MHz	9.3MHz

Operating Temperature Range: -40°C to +85°C

Continued on the following page.

Continued from the preceding page.

Part Number	Inductance	Test Frequency	Rated Current	Max. of DC Resistance	Q (min.)	Test Frequency	Self Resonance Frequency (min.)
LQH43MN560K03□	56μH±10%	1MHz	200mA	1.7ohm	35	1MHz	9.3MHz
LQH43MN680J03□	68μH±5%	1MHz	180mA	1.9ohm	35	1MHz	8.4MHz
LQH43MN680K03□	68μH±10%	1MHz	180mA	1.9ohm	35	1MHz	8.4MHz
LQH43MN820J03□	82μH±5%	1MHz	170mA	2.2ohm	35	1MHz	7.5MHz
LQH43MN820K03□	82μH±10%	1MHz	170mA	2.2ohm	35	1MHz	7.5MHz
LQH43MN101J03□	100μH±5%	1MHz	160mA	2.5ohm	40	796kHz	6.8MHz
LQH43MN101K03□	100μH±10%	1MHz	160mA	2.5ohm	40	796kHz	6.8MHz
LQH43MN121J03□	120μH±5%	1MHz	150mA	3.0ohm	40	796kHz	6.2MHz
LQH43MN121K03□	120μH±10%	1MHz	150mA	3.0ohm	40	796kHz	6.2MHz
LQH43MN151J03□	150μH±5%	1MHz	130mA	3.7ohm	40	796kHz	5.5MHz
LQH43MN151K03□	150μH±10%	1MHz	130mA	3.7ohm	40	796kHz	5.5MHz
LQH43MN181J03□	180μH±5%	1MHz	120mA	4.5ohm	40	796kHz	5MHz
LQH43MN181K03□	180μH±10%	1MHz	120mA	4.5ohm	40	796kHz	5MHz
LQH43MN221J03□	220μH±5%	1MHz	110mA	5.4ohm	40	796kHz	4.5MHz
LQH43MN221K03□	220μH±10%	1MHz	110mA	5.4ohm	40	796kHz	4.5MHz
LQH43MN271J03□	270μH±5%	1MHz	100mA	6.8ohm	40	796kHz	4MHz
LQH43MN271K03□	270μH±10%	1MHz	100mA	6.8ohm	40	796kHz	4MHz
LQH43MN331J03□	330μH±5%	1MHz	95mA	8.2ohm	40	796kHz	3.6MHz
LQH43MN331K03□	330μH±10%	1MHz	95mA	8.2ohm	40	796kHz	3.6MHz
LQH43MN391J03□	390μH±5%	1MHz	90mA	9.7ohm	40	796kHz	3.3MHz
LQH43MN391K03□	390μH±10%	1MHz	90mA	9.7ohm	40	796kHz	3.3MHz
LQH43MN471J03□	470μH±5%	1kHz	80mA	11.8ohm	40	796kHz	3MHz
LQH43MN471K03□	470μH±10%	1kHz	80mA	11.8ohm	40	796kHz	3MHz
LQH43MN561J03□	560μH±5%	1kHz	70mA	14.5ohm	40	796kHz	2.7MHz
LQH43MN561K03□	560μH±10%	1kHz	70mA	14.5ohm	40	796kHz	2.7MHz
LQH43MN681J03□	680μH±5%	1kHz	65mA	17.0ohm	40	796kHz	2.5MHz
LQH43MN681K03□	680μH±10%	1kHz	65mA	17.0ohm	40	796kHz	2.5MHz
LQH43MN821J03□	820μH±5%	1kHz	60mA	20.5ohm	40	796kHz	2.2MHz
LQH43MN821K03□	820μH±10%	1kHz	60mA	20.5ohm	40	796kHz	2.2MHz
LQH43MN102J03□	1000μH±5%	1kHz	50mA	25.0ohm	40	252kHz	2MHz
LQH43MN102K03□	1000μH±10%	1kHz	50mA	25.0ohm	40	252kHz	2MHz
LQH43MN122J03□	1200μH±5%	1kHz	45mA	30.0ohm	40	252kHz	1.8MHz
LQH43MN122K03□	1200μH±10%	1kHz	45mA	30.0ohm	40	252kHz	1.8MHz
LQH43MN152J03□	1500μH±5%	1kHz	40mA	37.0ohm	40	252kHz	1.6MHz
LQH43MN152K03□	1500μH±10%	1kHz	40mA	37.0ohm	40	252kHz	1.6MHz
LQH43NN182J03□	1800μH±5%	1kHz	35mA	45.0ohm	40	252kHz	1.5MHz
LQH43NN182K03□	1800μH±10%	1kHz	35mA	45.0ohm	40	252kHz	1.5MHz
LQH43NN222J03□	2200μH±5%	1kHz	30mA	50.0ohm	40	252kHz	1.3MHz
LQH43NN222K03□	2200μH±10%	1kHz	30mA	50.0ohm	40	252kHz	1.3MHz

Operating Temperature Range: -40°C to +85°C

■ Q - Frequency Characteristics (Typ.)

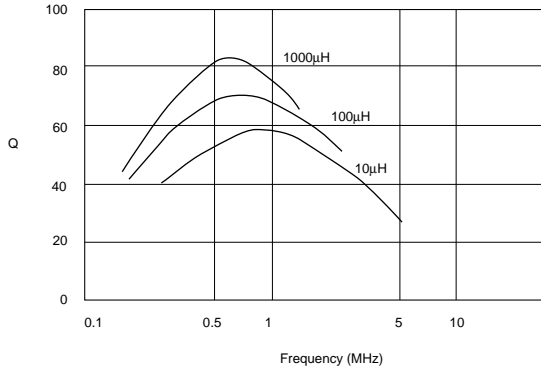

■ Inductance - Current Characteristics (Typ.)

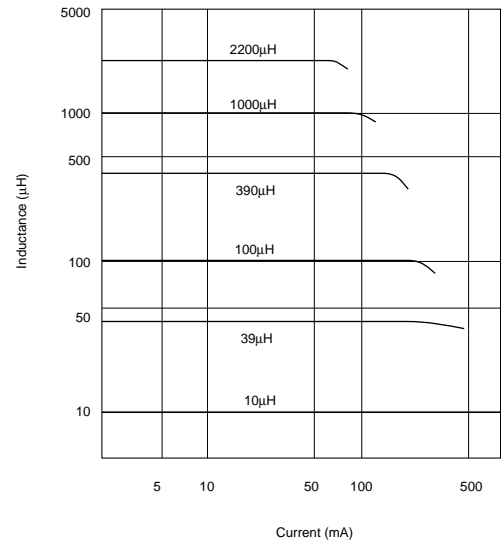

Chip Coils for DC-DC Converter Monolithic Type



LQM21P Series (0805 Size)

■ Features

1. Small size in 2.0x1.25mm
2. Low profile (h=0.55mm max.)
3. Large rated current of 1100mA
4. Magnetically shielded structure
5. Outstanding solder heat resistance, either flow or reflow soldering methods can be employed.

■ Dimensions

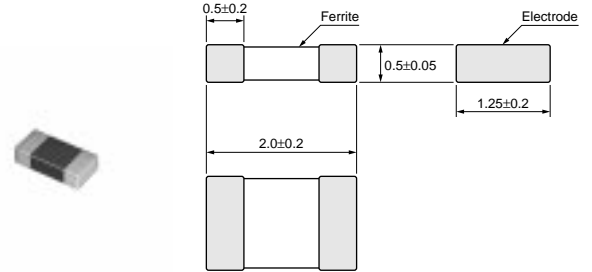

(in mm)

■ Applications

DC-DC converter circuits for mobile equipment

■ Rated Value (□: packaging code)

Part Number	Inductance	Test Frequency	Rated Current	DC Resistance	Self Resonance Frequency (min.)
LQM21PNR47MC0□	0.47μH±20%	1MHz	1100mA	0.12ohm±25%	100MHz
LQM21PN1R0MC0□	1.0μH±20%	1MHz	800mA	0.19ohm±25%	90MHz
LQM21PN1R5MC0□	1.5μH±20%	1MHz	700mA	0.26ohm±25%	70MHz
LQM21PN2R2MC0□	2.2μH±20%	1MHz	600mA	0.34ohm±25%	50MHz

Operating Temperature Range: -55°C to +125°C

■ Inductance - Frequency Characteristics

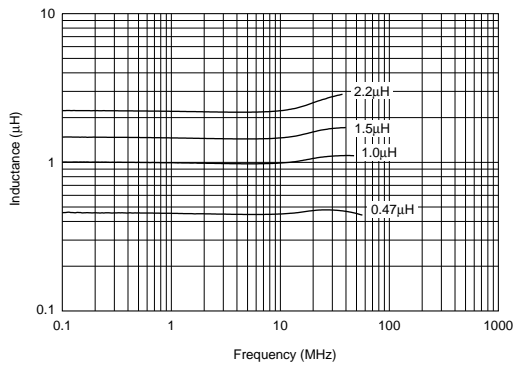

■ Inductance - Current Characteristics

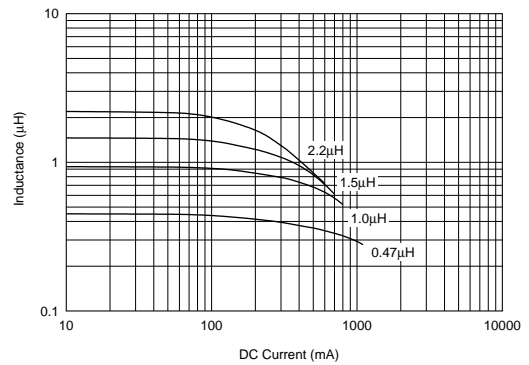

Chip Coils for DC-DC Converter Monolithic Type



LQM2MP_G0 Series (0806 Size)

■ Features

1. Large rated current of 1400mA (1.0 micro H)
2. Small size in 2.0x1.6mm and low profile in 1.0mm max.
3. Low DC resistance is realized.
4. Magnetically shielded structure
5. Applicable soldering methods are both flow soldering and reflow soldering.

■ Dimensions

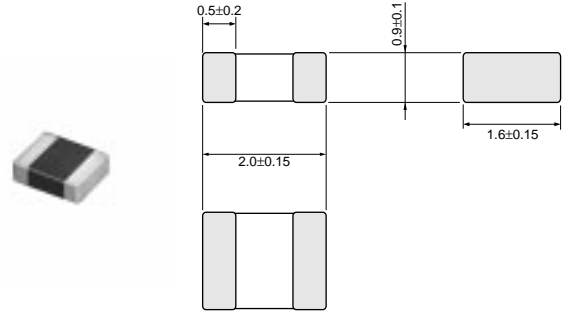

(in mm)

■ Applications

DC-DC converter circuits for mobile equipment

■ Rated Value (□: packaging code)

Part Number	Inductance	Test Frequency	Rated Current	DC Resistance	Self Resonance Frequency (min.)
LQM2MPNR47NG0□	0.47μH±30%	1MHz	1600mA	0.06ohm±25%	100MHz
LQM2MPN1R0NG0□	1.0μH±30%	1MHz	1400mA	0.085ohm±25%	60MHz
LQM2MPN1R5NG0□	1.5μH±30%	1MHz	1200mA	0.11ohm±25%	50MHz
LQM2MPN2R2NG0□	2.2μH±30%	1MHz	1200mA	0.11ohm±25%	40MHz
LQM2MPN3R3NG0□	3.3μH±30%	1MHz	1200mA	0.12ohm±25%	30MHz
LQM2MPN4R7NG0□	4.7μH±30%	1MHz	1100mA	0.14ohm±25%	20MHz

Operating Temperature Range: -55°C to +125°C

■ Inductance - Frequency Characteristics

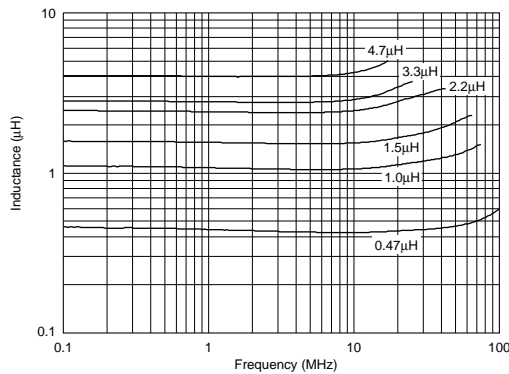

■ Inductance - Current Characteristics

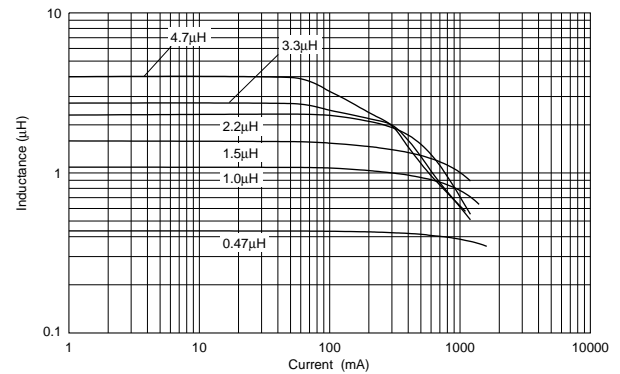

Chip Coils for DC-DC Converter Monolithic Type



LQM2HP_J0 Series (1008 Size)

■ Features

1. Large rated current of 1500mA (1.0 micro H)
2. Small size in 2.5x2.0mm and low profile in 1.2mm max.
3. Low DC resistance is realized.
4. Magnetically shielded structure
5. Applicable soldering methods are both flow soldering and reflow soldering.

■ Dimensions

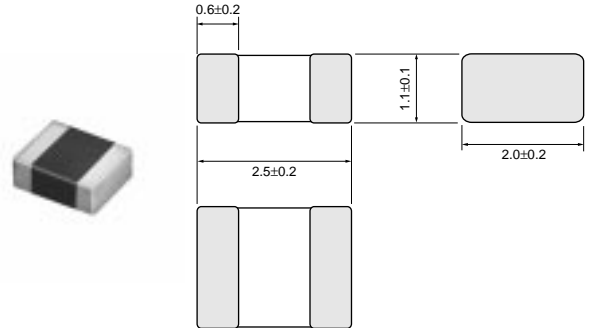

(in mm)

■ Applications

DC-DC converter circuits for mobile equipment

■ Rated Value (□: packaging code)

Part Number	Inductance	Test Frequency	Rated Current	DC Resistance	Self Resonance Frequency (min.)
LQM2HPN1R0MJ0□	1.0μH±20%	1MHz	1500mA	0.09ohm±25%	70MHz
LQM2HPN2R2MJ0□	2.2μH±20%	1MHz	1000mA	0.12ohm±25%	40MHz
LQM2HPN3R3MJ0□	3.3μH±20%	1MHz	1000mA	0.12ohm±25%	30MHz

Operating Temperature Range: -55°C to +125°C

8

■ Inductance - Frequency Characteristics

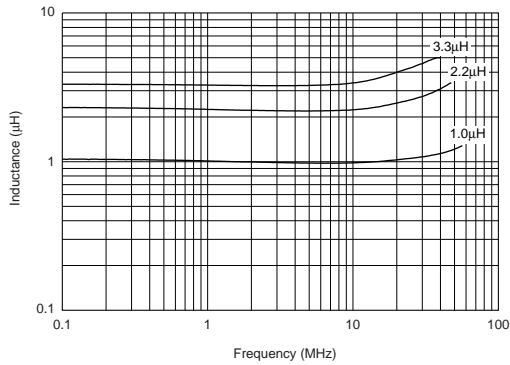

■ Inductance - Current Characteristics

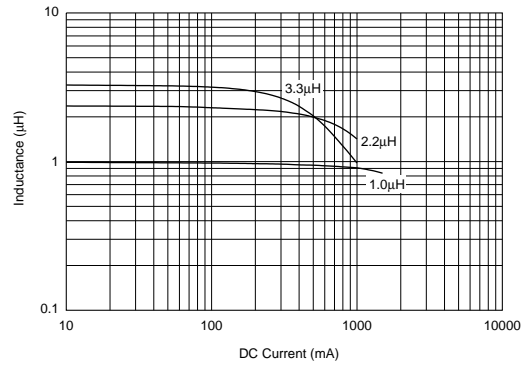

Chip Coils for DC-DC Converter Monolithic Type



LQM2HP_G0 Series (1008 Size)

■ Features

1. Large rated current of 1600mA (1.0 micro H)
2. Small size in 2.5x2.0mm and low profile in 1.0mm max.
3. Low DC resistance is realized.
4. Magnetically shielded structure
5. Applicable soldering methods are both flow soldering and reflow soldering.

■ Dimensions

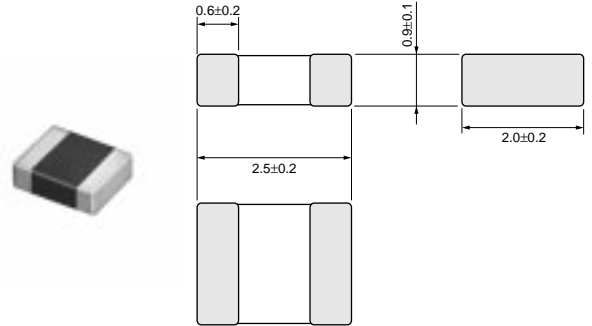

(in mm)

■ Applications

DC-DC converter circuits for mobile equipment

■ Rated Value (□: packaging code)

Part Number	Inductance	Test Frequency	Rated Current	DC Resistance	Self Resonance Frequency (min.)
LQM2HPNR47MG0□	0.47μH±20%	1MHz	1800mA	0.04ohm±25%	100MHz
LQM2HPN1R0MG0□	1.0μH±20%	1MHz	1600mA	0.055ohm±25%	60MHz
LQM2HPN1R5MG0□	1.5μH±20%	1MHz	1500mA	0.07ohm±25%	50MHz
LQM2HPN2R2MG0□	2.2μH±20%	1MHz	1300mA	0.08ohm±25%	40MHz
LQM2HPN3R3MG0□	3.3μH±20%	1MHz	1200mA	0.10ohm±25%	30MHz
LQM2HPN4R7MG0□	4.7μH±20%	1MHz	1100mA	0.11ohm±25%	25MHz

Operating Temperature Range: -55°C to +125°C

■ Inductance - Frequency Characteristics

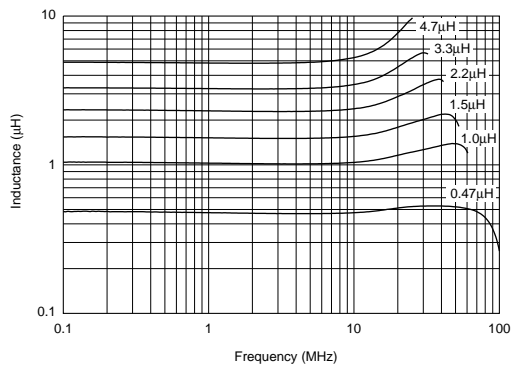

■ Inductance - Current Characteristics

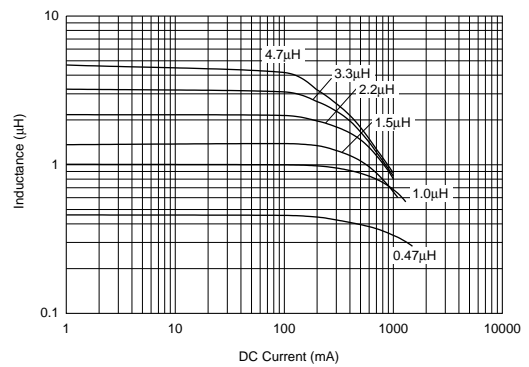

Chip Coils for DC-DC Converter Monolithic Type



LQM2HP_E0 Series (1008 Size)

■ Features

1. Large rated current of 1500mA (0.56micro H)
2. Small size in 2.5x2.0mm and low profile in 0.8mm max.
3. Low DC resistance is realized.
4. Magnetically shielded structure
5. Applicable soldering methods are both flow soldering and reflow soldering.

■ Dimensions

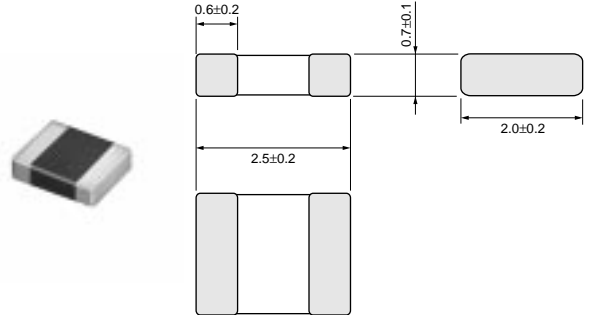

(in mm)

■ Applications

DC-DC converter circuits for mobile equipment

■ Rated Value (□: packaging code)

Part Number	Inductance	Test Frequency	Rated Current	DC Resistance	Self Resonance Frequency (min.)
LQM2HPNR56ME0□	0.56μH±20%	1MHz	1500mA	0.06ohm±25%	70MHz

Operating Temperature Range: -55°C to +125°C

8

■ Inductance - Frequency Characteristics

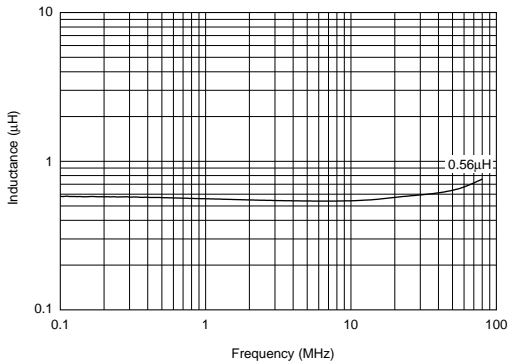

■ Inductance - Current Characteristics

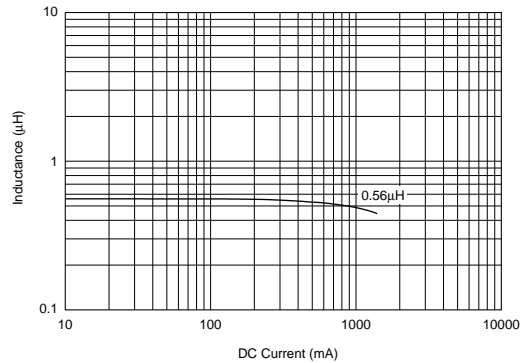

Chip Coils for DC-DC Converter Monolithic Type



LQM31P_00 Series (1206 Size)

■ Features

1. Large rated current of 1400mA
2. Small size in 3.2x1.6mm and low profile (h=0.95mm max.)
3. Low DC resistance
4. Magnetically shielded structure
5. Applicable soldering methods are both flow soldering and reflow soldering.

■ Dimensions

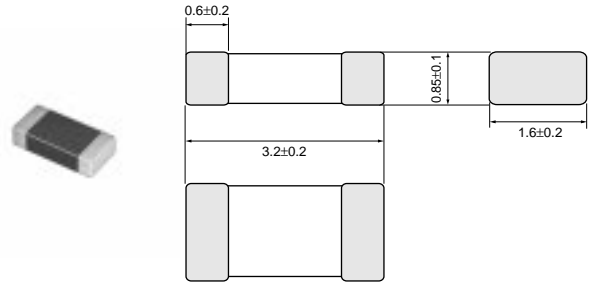

(in mm)

■ Applications

DC-DC converter circuits for mobile equipment

■ Rated Value (□: packaging code)

Part Number	Inductance	Test Frequency	Rated Current	DC Resistance	Self Resonance Frequency (min.)
LQM31PNR47M00□	0.47μH±20%	1MHz	1400mA	0.07ohm±25%	80MHz
LQM31PN1R0M00□	1.0μH±20%	1MHz	1200mA	0.12ohm±25%	60MHz
LQM31PN1R5M00□	1.5μH±20%	1MHz	1000mA	0.14ohm±25%	50MHz
LQM31PN2R2M00□	2.2μH±20%	1MHz	900mA	0.19ohm±25%	40MHz
LQM31PN3R3M00□	3.3μH±20%	1MHz	800mA	0.24ohm±25%	30MHz
LQM31PN4R7M00□	4.7μH±20%	1MHz	700mA	0.30ohm±25%	25MHz

Operating Temperature Range: -55°C to +125°C

■ Inductance - Frequency Characteristics

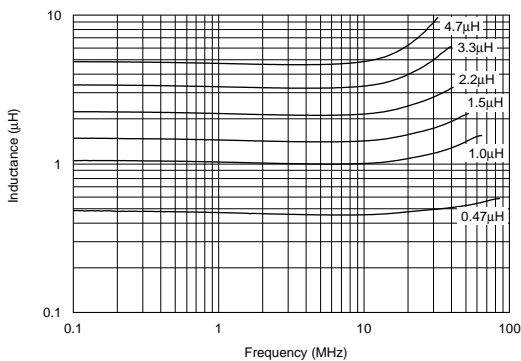

■ Inductance - Current Characteristics

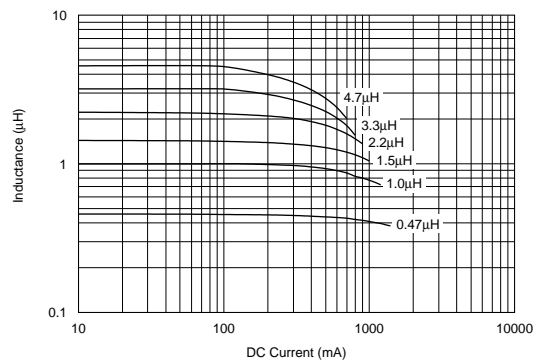

Chip Coils for DC-DC Converter Monolithic Type



LQM31P_C0 Series (1206 Size)

■ Features

1. Large rated current of 1100mA
2. Small size in 3.2x1.6mm and low profile (h=0.55mm max.)
3. Low DC resistance
4. Magnetically shielded structure
5. Applicable soldering methods are both flow soldering and reflow soldering.

■ Dimensions

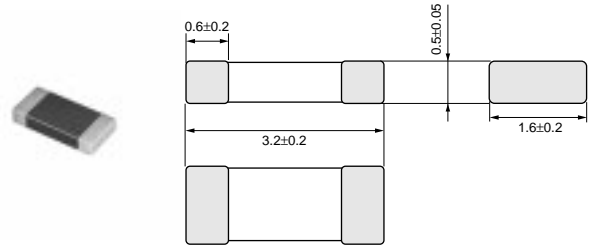

(in mm)

■ Applications

DC-DC converter circuits for mobile equipment

■ Rated Value (□: packaging code)

Part Number	Inductance	Test Frequency	Rated Current	DC Resistance	Self Resonance Frequency (min.)
LQM31PNR47MC0□	0.47μH±20%	1MHz	1300mA	0.085ohm±25%	90MHz
LQM31PN1R0MC0□	1.0μH±20%	1MHz	1100mA	0.14ohm±25%	70MHz
LQM31PN1R5MC0□	1.5μH±20%	1MHz	1000mA	0.17ohm±25%	60MHz
LQM31PN2R2MC0□	2.2μH±20%	1MHz	900mA	0.25ohm±25%	50MHz

Operating Temperature Range: -55°C to +125°C

■ Inductance - Frequency Characteristics

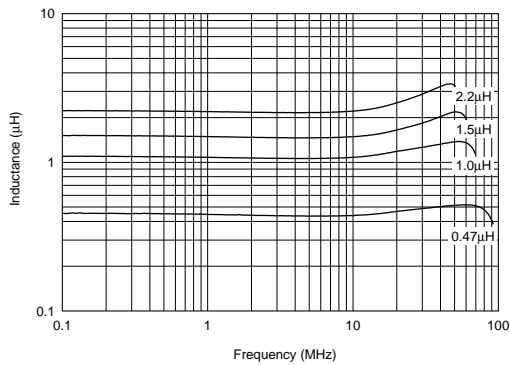

■ Inductance - Current Characteristics

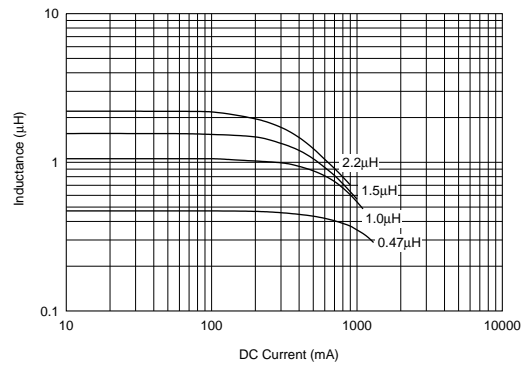

Chip Coils for DC-DC Converter Wire Wound Type



LQH2MC_02 Series (0806 Size)

■ Features

1. Wire wound type with 0.95mm (max.) low-profile
2. Size: 2.0x1.6mm
3. Allowable DC current: 485mA (1.0 micro H)
4. Wide inductance range: 1.0 to 82 micro H

■ Applications

For DC-DC converter

■ Dimensions

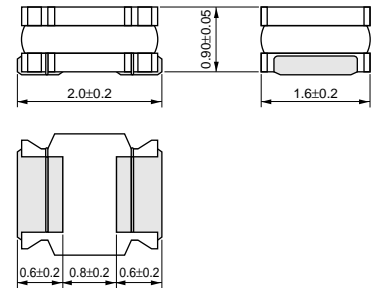

(in mm)

■ Rated Value (□: packaging code)

Part Number	Inductance	Inductance Test Frequency	*1 Allowable DC Current (Based on Temperature Rise)	*2 Allowable DC Current (Based on Inductance Change)	DC Resistance	Self Resonance Frequency (min.)
LQH2MCN1R0M02□	1.0μH±20%	1MHz	485mA	-	0.30ohm±30%	100MHz
LQH2MCN1R5M02□	1.5μH±20%	1MHz	445mA	-	0.40ohm±30%	95MHz
LQH2MCN2R2M02□	2.2μH±20%	1MHz	425mA	-	0.48ohm±30%	70MHz
LQH2MCN3R3M02□	3.3μH±20%	1MHz	375mA	-	0.60ohm±30%	65MHz
LQH2MCN4R7M02□	4.7μH±20%	1MHz	300mA	-	0.8ohm±30%	60MHz
LQH2MCN5R6M02□	5.6μH±20%	1MHz	280mA	-	0.9ohm±30%	60MHz
LQH2MCN6R8M02□	6.8μH±20%	1MHz	255mA	-	1.0ohm±30%	55MHz
LQH2MCN8R2M02□	8.2μH±20%	1MHz	235mA	-	1.1ohm±30%	50MHz
LQH2MCN100K02□	10μH±10%	1MHz	225mA	-	1.2ohm±30%	48MHz
LQH2MCN120K02□	12μH±10%	1MHz	210mA	-	1.4ohm±30%	44MHz
LQH2MCN150K02□	15μH±10%	1MHz	200mA	-	1.6ohm±30%	40MHz
LQH2MCN180K02□	18μH±10%	1MHz	190mA	-	1.8ohm±30%	35MHz
LQH2MCN220K02□	22μH±10%	1MHz	185mA	-	2.1ohm±30%	30MHz
LQH2MCN270K02□	27μH±10%	1MHz	180mA	-	2.5ohm±30%	30MHz
LQH2MCN330K02□	33μH±10%	1MHz	160mA	-	2.8ohm±30%	28MHz
LQH2MCN390K02□	39μH±10%	1MHz	125mA	-	4.4ohm±30%	24MHz
LQH2MCN470K02□	47μH±10%	1MHz	120mA	-	5.1ohm±30%	18MHz
LQH2MCN560K02□	56μH±10%	1MHz	110mA	-	5.7ohm±30%	17MHz
LQH2MCN680K02□	68μH±10%	1MHz	100mA	-	6.6ohm±30%	14MHz
LQH2MCN820K02□	82μH±10%	1MHz	90mA	-	7.5ohm±30%	14MHz

Operating Temperature Range: -40°C to +85°C Only for reflow soldering.

*1: When applied Allowable DC Current is applied to the Products, self-generation of heat will rise to 40°C or less.

*2: When applied Allowable DC Current is applied to the Products, Inductance will be within ±30% of nominal Inductance value.

■ Inductance - Frequency Characteristics (Typ.)

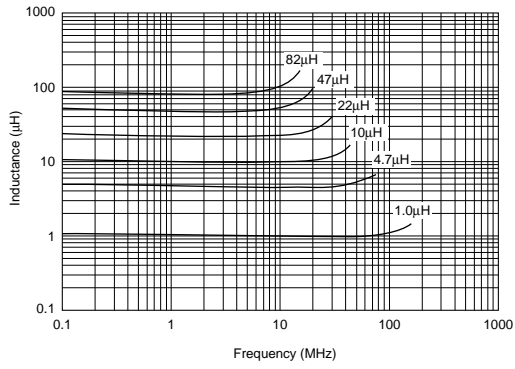

■ Inductance - Current Characteristics (Typ.)

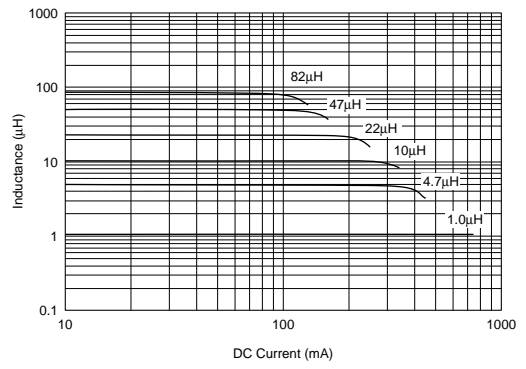

Chip Coils for DC-DC Converter Wire Wound Type



LQH2MC_52 Series (0806 Size)

■ Features

1. Wire wound type with 0.70mm (max.) ultra low-profile
2. Size: 2.0x1.6mm
3. Allowable DC current: 595mA (1.0 micro H)
4. Inductance range: 1.0 to 10 micro H

■ Applications

For DC-DC converter

■ Dimensions

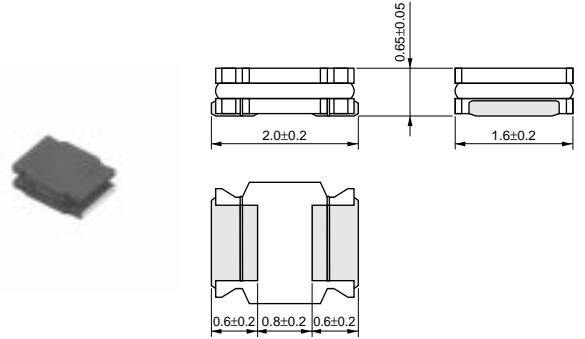

(in mm)

■ Rated Value (□: packaging code)

Part Number	Inductance	Inductance Test Frequency	*1 Allowable DC Current (Based on Temperature Rise)	*2 Allowable DC Current (Based on Inductance Change)	DC Resistance	Self Resonance Frequency (min.)
LQH2MCN1R0M52□	1.0μH±20%	1MHz	595mA	-	0.25ohm±30%	215MHz
LQH2MCN1R5M52□	1.5μH±20%	1MHz	540mA	-	0.33ohm±30%	165MHz
LQH2MCN2R2M52□	2.2μH±20%	1MHz	500mA	-	0.42ohm±30%	125MHz
LQH2MCN3R3M52□	3.3μH±20%	1MHz	360mA	-	0.74ohm±30%	110MHz
LQH2MCN4R7M52□	4.7μH±20%	1MHz	335mA	-	0.91ohm±30%	90MHz
LQH2MCN6R8M52□	6.8μH±20%	1MHz	285mA	-	1.23ohm±30%	65MHz
LQH2MCN100M52□	10μH±20%	1MHz	200mA	-	2.27ohm±30%	60MHz

Operating Temperature Range: -40°C to +85°C Only for reflow soldering.

*1: When applied Allowable DC Current is applied to the Products, self-generation of heat will rise to 40°C or less.

*2: When applied Allowable DC Current is applied to the Products, Inductance will be within ±30% of nominal Inductance value.

■ Inductance - Frequency Characteristics (Typ.)

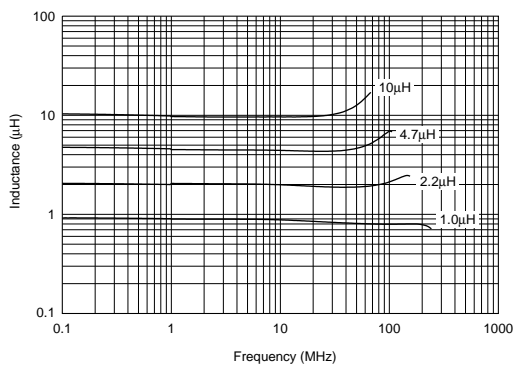

■ Inductance - Current Characteristics (Typ.)

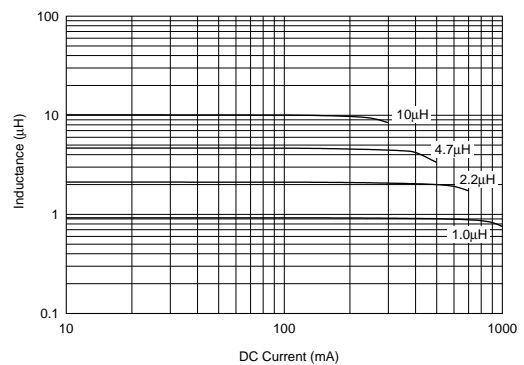

Chip Coils for DC-DC Converter Wire Wound Type



LQH3NP_M0 Series (1212 Size)

■ Features

1. Large allowable DC current
Based on Inductance change: 1400mA at 1.0 micro H
Based on Temperature rise: 2050mA at 1.0 micro H
2. The series has an inductance range from 1.0 to 100 micro H.
3. Magnetically shielded structure.
4. Lead-free reflow soldering is available.

■ Dimensions

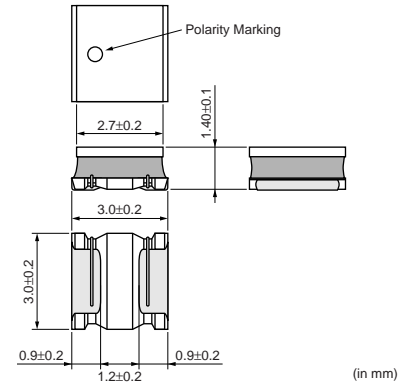

■ Applications

For DC-DC converter

■ Rated Value (□: packaging code)

Part Number	Inductance	Inductance Test Frequency	*1 Allowable DC Current (Based on Temperature Rise)	*2 Allowable DC Current (Based on Inductance Change)	DC Resistance	Self Resonance Frequency (min.)
LQH3NPN1R0NM0□	1.0μH±30%	1MHz	2050mA	1400mA	0.044ohm±20%	130MHz
LQH3NPN2R2NM0□	2.2μH±30%	1MHz	1600mA	1250mA	0.073ohm±20%	90MHz
LQH3NPN3R3NM0□	3.3μH±30%	1MHz	1450mA	1000mA	0.092ohm±20%	75MHz
LQH3NPN4R7NM0□	4.7μH±30%	1MHz	1250mA	880mA	0.13ohm±20%	65MHz
LQH3NPN6R8NM0□	6.8μH±30%	1MHz	1000mA	820mA	0.20ohm±20%	50MHz
LQH3NPN100NM0□	10μH±30%	1MHz	870mA	550mA	0.26ohm±20%	45MHz
LQH3NPN220MM0□	22μH±20%	1MHz	650mA	410mA	0.51ohm±20%	28MHz
LQH3NPN330MM0□	33μH±20%	1MHz	500mA	370mA	0.85ohm±20%	22MHz
LQH3NPN470MM0□	47μH±20%	1MHz	410mA	310mA	1.25ohm±20%	18MHz
LQH3NPN101MM0□	100μH±20%	1MHz	240mA	200mA	3.50ohm±20%	12MHz

Operating Temperature Range: -40°C to +85°C Only for reflow soldering.

*1: When applied Allowable DC Current is applied to the Products, self-generation of heat will rise to 40°C or less.

*2: When applied Allowable DC Current is applied to the Products, Inductance will be within ±30% of nominal Inductance value.

■ Inductance - Frequency Characteristics (Typ.)

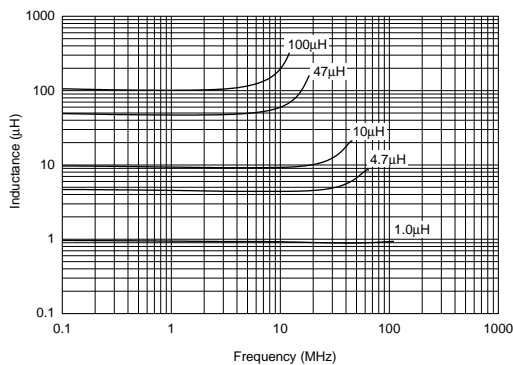

■ Inductance - Current Characteristics (Typ.)

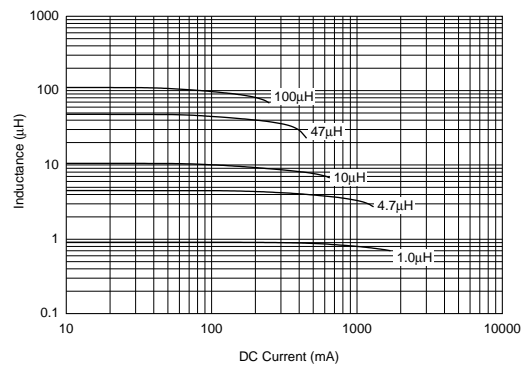

Chip Coils for DC-DC Converter Wire Wound Type



LQH3NP_G0 Series (1212 Size)

■ Features

1. Low profile (h=1.0mm max.)
2. Small size in 3.0x3.0mm
3. Large allowable DC current of 1525mA (1.0 micro H)
4. Magnetically shielded structure
5. Lead-free reflow soldering is available.

■ Dimensions

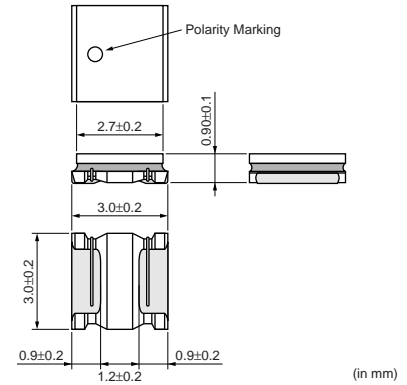

■ Applications

For DC-DC converter

■ Rated Value (□: packaging code)

Part Number	Inductance	Inductance Test Frequency	*1 Allowable DC Current (Based on Temperature Rise)	*2 Allowable DC Current (Based on Inductance Change)	DC Resistance	Self Resonance Frequency (min.)
LQH3NPN1R0NG0□	1.0μH±30%	1MHz	1525mA	1650mA	0.08ohm±20%	160MHz
LQH3NPN1R5NG0□	1.5μH±30%	1MHz	1470mA	1300mA	0.10ohm±20%	130MHz
LQH3NPN2R2NG0□	2.2μH±30%	1MHz	1270mA	1250mA	0.14ohm±20%	100MHz
LQH3NPN3R3NG0□	3.3μH±30%	1MHz	1130mA	850mA	0.18ohm±20%	75MHz
LQH3NPN4R7NG0□	4.7μH±30%	1MHz	925mA	800mA	0.26ohm±20%	60MHz
LQH3NPN6R8NG0□	6.8μH±30%	1MHz	710mA	650mA	0.45ohm±20%	48MHz
LQH3NPN100NG0□	10μH±30%	1MHz	630mA	500mA	0.57ohm±20%	45MHz
LQH3NPN150NG0□	15μH±30%	1MHz	475mA	370mA	0.91ohm±20%	35MHz
LQH3NPN220MG0□	22μH±20%	1MHz	430mA	340mA	1.1ohm±20%	25MHz
LQH3NPN220NG0□	22μH±30%	1MHz	430mA	340mA	1.1ohm±20%	25MHz
LQH3NPN330MG0□	33μH±20%	1MHz	345mA	250mA	2.1ohm±20%	24MHz
LQH3NPN330NG0□	33μH±30%	1MHz	345mA	250mA	2.1ohm±20%	24MHz
LQH3NPN470MG0□	47μH±20%	1MHz	270mA	170mA	3.0ohm±20%	19MHz
LQH3NPN470NG0□	47μH±30%	1MHz	270mA	170mA	3.0ohm±20%	19MHz
LQH3NPN680MG0□	68μH±20%	1MHz	235mA	150mA	4.2ohm±20%	16MHz
LQH3NPN680NG0□	68μH±30%	1MHz	235mA	150mA	4.2ohm±20%	16MHz
LQH3NPN101MG0□	100μH±20%	1MHz	165mA	140mA	8.0ohm±20%	10MHz
LQH3NPN101NG0□	100μH±30%	1MHz	165mA	140mA	8.0ohm±20%	10MHz
LQH3NPN151MG0□	150μH±20%	1MHz	145mA	110mA	11.0ohm±20%	10MHz
LQH3NPN151NG0□	150μH±30%	1MHz	145mA	110mA	11.0ohm±20%	10MHz
LQH3NPN221MG0□	220μH±20%	1MHz	130mA	100mA	14.0ohm±20%	8.5MHz
LQH3NPN221NG0□	220μH±30%	1MHz	130mA	100mA	14.0ohm±20%	8.5MHz
LQH3NPN251MG0□	250μH±20%	1MHz	130mA	80mA	15.0ohm±20%	8.0MHz
LQH3NPN251NG0□	250μH±30%	1MHz	130mA	80mA	15.0ohm±20%	8.0MHz

Operating Temperature Range: -40°C to +85°C Only for reflow soldering.

*1: When applied Allowable DC Current is applied to the Products, self-generation of heat will rise to 40°C or less.

*2: When applied Allowable DC Current is applied to the Products, Inductance will be within ±30% of nominal Inductance value.

■ Inductance - Frequency Characteristics (Typ.)

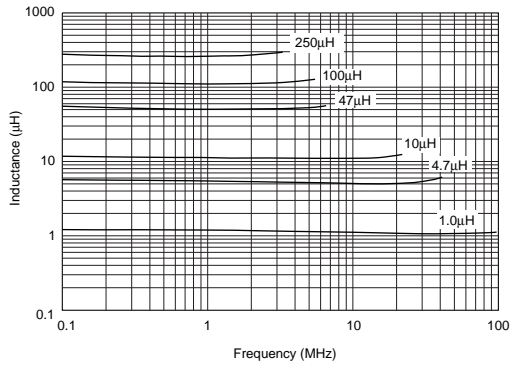

■ Inductance - Current Characteristics (Typ.)

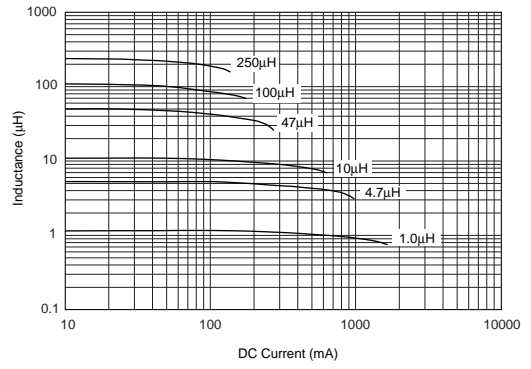

Chip Coils for DC-DC Converter Wire Wound Type



LQH32P_N0 Series (1210 Size)

■ Features

1. Large allowable DC current of 2550mA (0.47 micro H)
2. The series has an inductance range from 0.47 to 22 micro H.
3. Magnetically shielded structure
4. Lead-free reflow soldering is available.

■ Applications

1. DSC, DVC, and 3.5/2.5 inch HDD
2. DC-DC converter for communication module of WiMAX

■ Dimensions

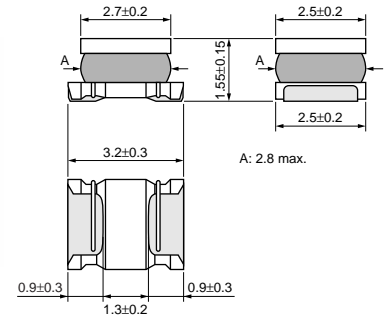

(in mm)

■ Rated Value (□: packaging code)

Part Number	Inductance	Inductance Test Frequency	*1 Allowable DC Current (Based on Temperature Rise)	*2 Allowable DC Current (Based on Inductance Change)	DC Resistance	Self Resonance Frequency (min.)
LQH32PNR47NN0□	0.47μH±30%	1MHz	2550mA	3400mA	0.03ohm±20%	100MHz
LQH32PN1R0NN0□	1.0μH±30%	1MHz	2050mA	2300mA	0.045ohm±20%	100MHz
LQH32PN1R5NN0□	1.5μH±30%	1MHz	1750mA	1750mA	0.057ohm±20%	70MHz
LQH32PN2R2NN0□	2.2μH±30%	1MHz	1600mA	1550mA	0.076ohm±20%	70MHz
LQH32PN3R3NN0□	3.3μH±30%	1MHz	1200mA	1250mA	0.12ohm±20%	50MHz
LQH32PN4R7NN0□	4.7μH±30%	1MHz	1000mA	1000mA	0.18ohm±20%	40MHz
LQH32PN6R8NN0□	6.8μH±30%	1MHz	850mA	850mA	0.24ohm±20%	40MHz
LQH32PN100MN0□	10μH±20%	1MHz	700mA	750mA	0.38ohm±20%	30MHz
LQH32PN220MN0□	22μH±20%	1MHz	450mA	500mA	0.81ohm±20%	20MHz

Operating Temperature Range: -40°C to +85°C Only for reflow soldering.

*1: When applied Allowable DC Current is applied to the Products, self-generation of heat will rise to 40°C or less.

*2: When applied Allowable DC Current is applied to the Products, Inductance will be within ±30% of nominal Inductance value.

■ Inductance - Frequency Characteristics (Typ.)

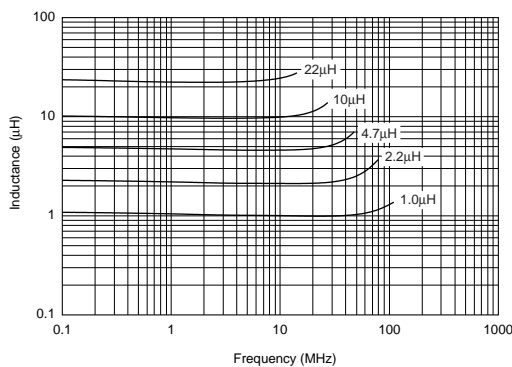

■ Inductance - Current Characteristics (Typ.)

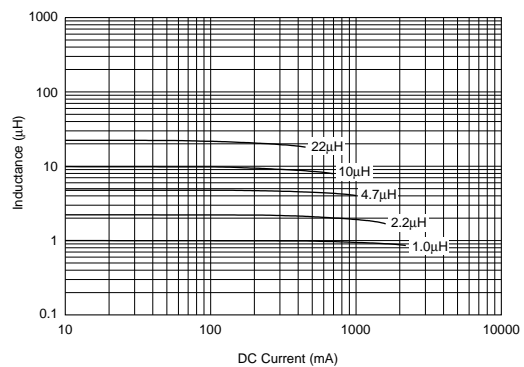

Chip Coils for DC-DC Converter Wire Wound Type



LQH55P Series (2220 Size)

■ Features

1. Large allowable DC current of 2600mA (at 1.2 micro H).
2. The series has an inductance range from 1.2 micro H to 22 micro H.
3. Magnetically shielded structure.
4. Reflow soldering methods can be employed.

■ Applications

For DC-DC converter

■ Dimensions

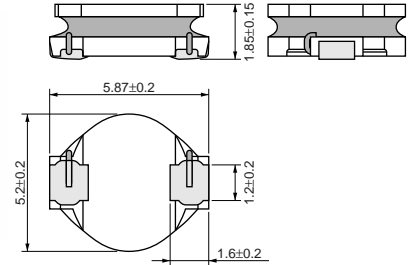

(in mm)

■ Rated Value (□: packaging code)

Part Number	Inductance	Inductance Test Frequency	*1 Allowable DC Current (Based on Temperature Rise)	*2 Allowable DC Current (Based on Inductance Change)	DC Resistance	Self Resonance Frequency (min.)
LQH55PN1R2NR0□	1.2 μ H \pm 30%	100kHz	2900mA	2600mA	0.021ohm \pm 20%	80MHz
LQH55PN2R2NR0□	2.2 μ H \pm 30%	100kHz	2500mA	2100mA	0.031ohm \pm 20%	60MHz
LQH55PN2R7NR0□	2.7 μ H \pm 30%	100kHz	2150mA	2070mA	0.040ohm \pm 20%	50MHz
LQH55PN3R3NR0□	3.3 μ H \pm 30%	100kHz	2000mA	2000mA	0.044ohm \pm 20%	35MHz
LQH55PN4R7NR0□	4.7 μ H \pm 30%	100kHz	1750mA	1400mA	0.060ohm \pm 20%	30MHz
LQH55PN6R8NR0□	6.8 μ H \pm 30%	100kHz	1450mA	1200mA	0.087ohm \pm 20%	25MHz
LQH55PN100MR0□	10 μ H \pm 20%	100kHz	1250mA	1000mA	0.11ohm \pm 20%	20MHz
LQH55PN220MR0□	22 μ H \pm 20%	100kHz	850mA	670mA	0.26ohm \pm 20%	10MHz

Operating Temperature Range: -40°C to +85°C Only for reflow soldering.

*1: When applied Allowable DC Current is applied to the Products, self-generation of heat will rise to 40°C or less.

*2: When applied Allowable DC Current is applied to the Products, Inductance will be within \pm 30% of nominal Inductance value.

■ Inductance - Frequency Characteristics (Typ.)

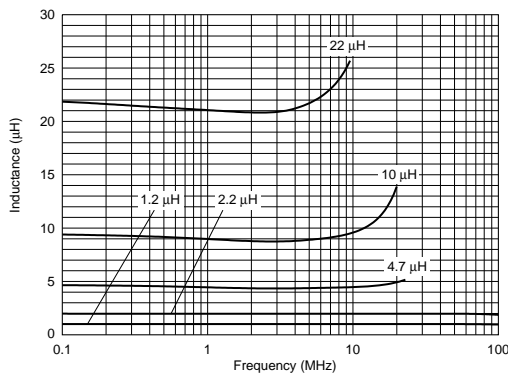

■ Inductance - Current Characteristics (Typ.)

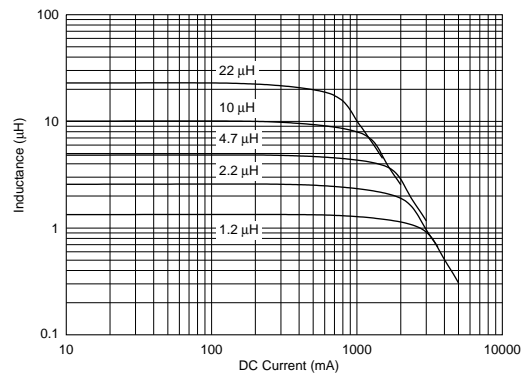

Chip Coils for Choke Monolithic Type



LQM18F Series (0603 Size)

■ Features

1. Ultra small size in 1.6x0.8mm and lightweight.
2. Special ferrite material, whose inductance change caused by bias current is small, enables large rated current of 50mA at 10 micro H.
3. The lowest DC resistance
4. Magnetically shielded structure enables good crosstalk characteristics.
5. Both flow and reflow soldering methods can be employed due to high heat resistant electrode structure.

■ Dimensions

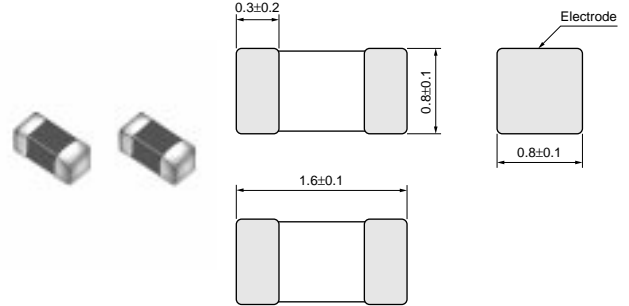

(in mm)

■ Applications

Choke circuits in DC power line of compact mobile equipment such as mobile phones, digital still cameras, digital video cameras, and music players.

■ Rated Value (□: packaging code)

Part Number	Inductance	Test Frequency	Rated Current	DC Resistance	Self Resonance Frequency (min.)
LQM18FN1R0M00□	1.0μH±20%	1MHz	150mA	0.20ohm±30%	120MHz
LQM18FN2R2M00□	2.2μH±20%	1MHz	120mA	0.40ohm±30%	80MHz
LQM18FN4R7M00□	4.7μH±20%	1MHz	80mA	0.60ohm±30%	50MHz
LQM18FN100M00□	10μH±20%	1MHz	50mA	0.90ohm±30%	30MHz

Operating Temperature Range: -55°C to +125°C

■ Impedance - Frequency Characteristics

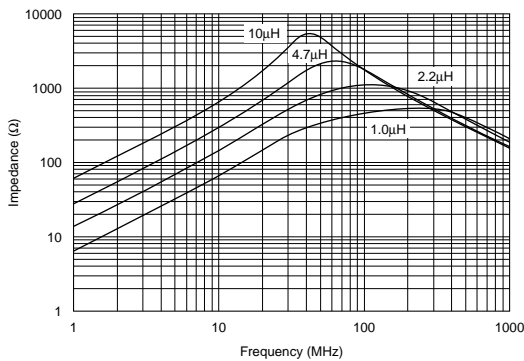

■ Inductance - Current Characteristics

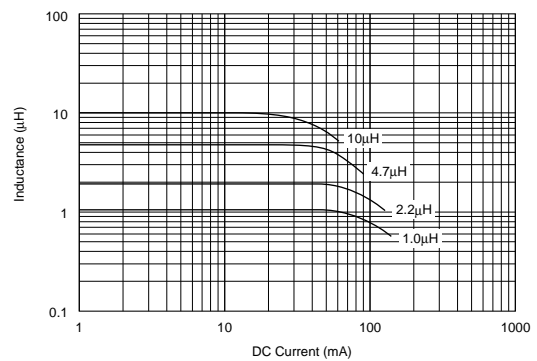

Chip Coils for Choke Monolithic Type



LQM21D Series (0805 Size)

LQM21D series consists of magnetically shielded chip inductors. It has less than half the DC resistance of our conventional monolithic chip inductors as well as high inductance.

■ Features

1. The inductors have very low DC resistance.
2. The series has an inductance range of 1.0 micro H to 47 micro H.
3. Magnetically shielded structure provides excellent crosstalk characteristics.
4. Compact (2.0x1.25mm) and lightweight
5. Applicable soldering methods are both flow soldering and reflow soldering.

■ Dimensions

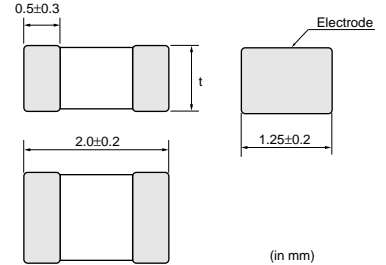

Dimension of t	Inductance: 1.0 to 10 μ H	0.85 \pm 0.2
	Inductance: 22 to 47 μ H	1.25 \pm 0.2

■ Rated Value (□: packaging code)

Part Number	Inductance	Test Frequency	Rated Current	Max. of DC Resistance	Self Resonance Frequency (min.)
LQM21DN1R0N00□	1.0 μ H \pm 30%	1MHz	60mA	0.10ohm	75MHz
LQM21DN2R2N00□	2.2 μ H \pm 30%	1MHz	40mA	0.17ohm	50MHz
LQM21DN4R7N00□	4.7 μ H \pm 30%	1MHz	30mA	0.30ohm	35MHz
LQM21DN100N00□	10 μ H \pm 30%	1MHz	15mA	0.50ohm	24MHz
LQM21DN220N00□	22 μ H \pm 30%	1MHz	13mA	0.65ohm	16MHz
LQM21DN470N00□	47 μ H \pm 30%	1MHz	7mA	1.20ohm	7.5MHz

Operating Temperature Range: -40°C to +85°C

■ Impedance - Frequency Characteristics

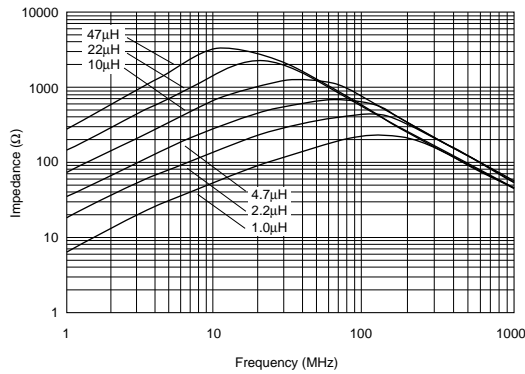

■ Inductance - Current Characteristics

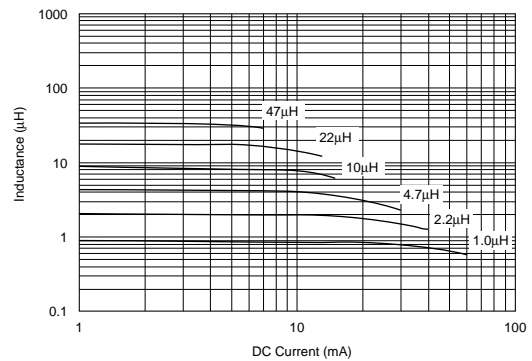

Chip Coils for Choke Monolithic Type



LQM21F_00 Series (0805 Size)

LQM21F series consists of magnetically shielded chip coils based on Murata's technologies of multilayer process and magnetic materials. Excellent direct current characteristics are realized by using magnetic materials which have excellent saturation characteristics. The inductance of LQM21F is four times as large as that of conventional items.

■ Dimensions

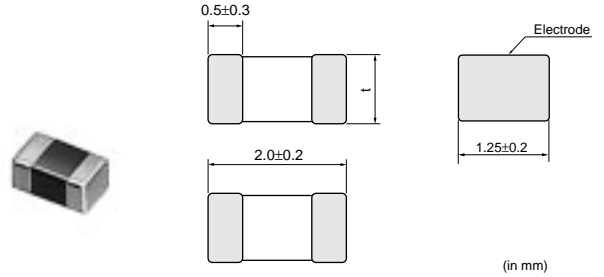

Dimension of t	Inductance: 1.0 to 2.2μH	0.85±0.2
	Inductance: 4.7 to 47μH	1.25±0.2

■ Features

1. LQM21F series is suitable for power line choke coils because of its excellent direct current characteristics. The series has larger rated current (60mA at 10 micro H) than conventional rated current.
2. Low DC resistance is realized.
3. The crosstalk characteristics are excellent because of the use of magnetically shielded structure.
4. Small size (2.0x1.25mm) and lightweight
5. Applicable soldering methods are both flow soldering and reflow soldering.

■ Rated Value (□: packaging code)

Part Number	Inductance	Test Frequency	Rated Current	DC Resistance	Self Resonance Frequency (min.)
LQM21FN1R0N00□	1.0μH±30%	1MHz	220mA	0.20ohm±30%	105MHz
LQM21FN2R2N00□	2.2μH±30%	1MHz	150mA	0.28ohm±30%	70MHz
LQM21FN4R7N00□	4.7μH±30%	1MHz	80mA	0.30ohm±30%	25MHz
LQM21FN100N00□	10μH±30%	1MHz	60mA	0.50ohm±30%	15MHz
LQM21FN220N00□	22μH±30%	1MHz	13mA	0.35ohm±30%	15MHz
LQM21FN470N00□	47μH±30%	1MHz	7mA	0.60ohm±30%	7.5MHz

Operating Temperature Range: -40°C to +85°C

■ Impedance - Frequency Characteristics

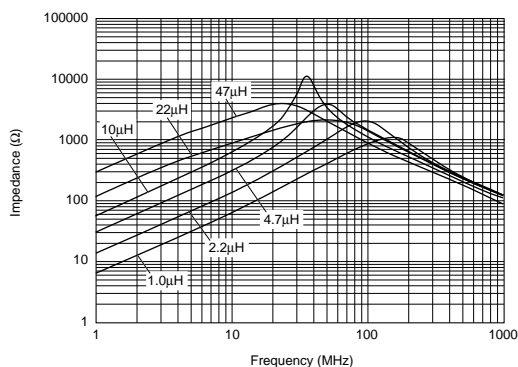

■ Inductance - Current Characteristics

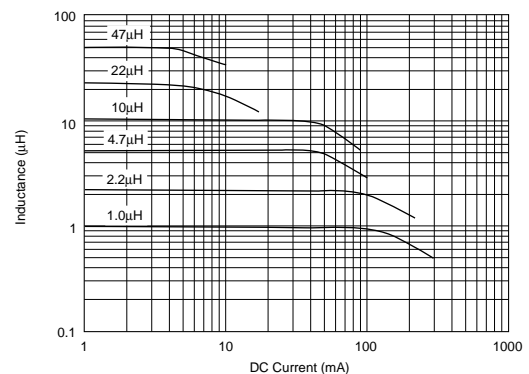

Chip Coils for Choke Monolithic Type



LQM21F_70 Series (0805 Size)

■ Features

Rated Current is larger than previous (LQM21F_00) series.

Rated Current: 100mA (10 micro H)

■ Dimensions

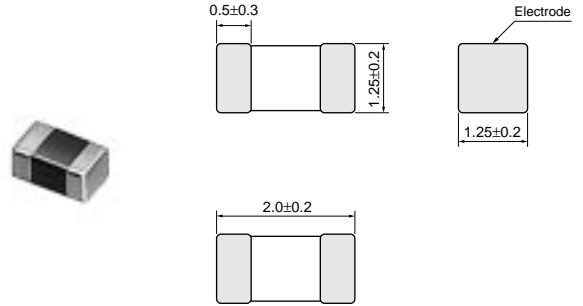

(in mm)

■ Rated Value (□: packaging code)

Part Number	Inductance	Test Frequency	Rated Current	DC Resistance	Self Resonance Frequency (min.)
LQM21FN4R7M70□	4.7 μ H \pm 20%	1MHz	120mA	0.35ohm \pm 30%	25MHz
LQM21FN100M70□	10 μ H \pm 20%	1MHz	100mA	0.60ohm \pm 30%	15MHz

Operating Temperature Range: -55°C to +125°C

■ Impedance - Frequency Characteristics

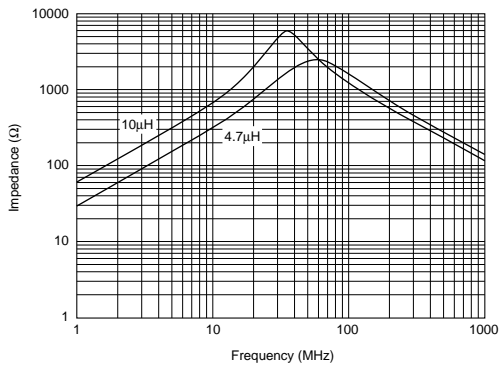

■ Inductance - Current Characteristics

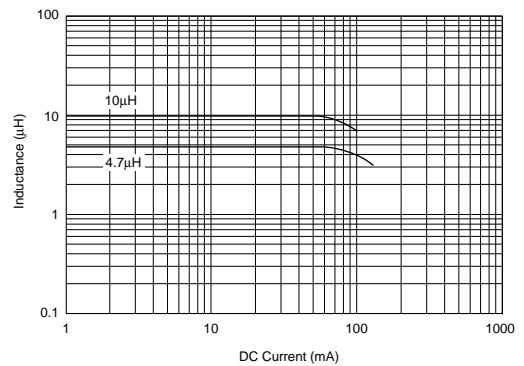

10

Chip Coils for Choke Monolithic Type



LQM21F_80 Series (0805 Size)

■ Features

1. Low DC resistance is realized.
LQM21F_80 series reduces about 50% DC resistance in comparison with LQM21F_70 series.
2. Small size in 2.0x1.25mm and large rated current of 120mA (4.7 micro H).
3. Magnetically shielded structure
4. Applicable soldering methods are both flow soldering and reflow soldering.

■ Dimensions

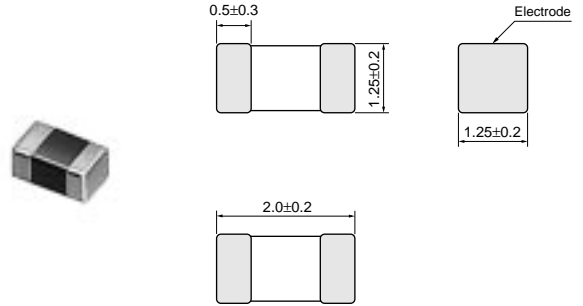

(in mm)

■ Applications

Choke circuits in DC power line of compact mobile equipment such as mobile phones, DSC, DVC.

■ Rated Value (□: packaging code)

Part Number	Inductance	Test Frequency	Rated Current	DC Resistance	Self Resonance Frequency (min.)
LQM21FN4R7M80□	4.7 μ H \pm 20%	1MHz	120mA	0.18ohm \pm 30%	25MHz
LQM21FN100M80□	10 μ H \pm 20%	1MHz	100mA	0.30ohm \pm 30%	15MHz

Operating Temperature Range: -55°C to +125°C

■ Impedance - Frequency Characteristics

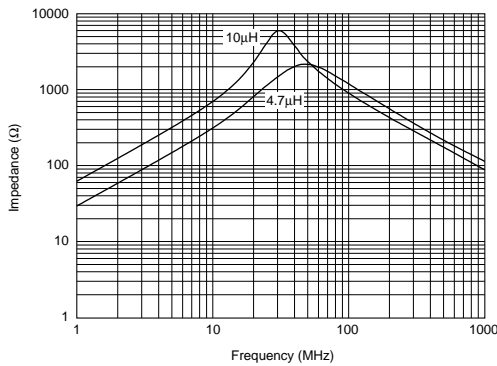

■ Inductance - Current Characteristics

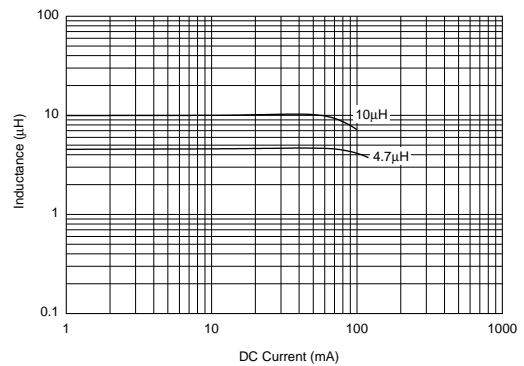

Chip Coils for Choke Monolithic Type



LQM31F Series (1206 Size)

LQM31F series consists of magnetically shielded chip coils based on Murata's technologies of multilayer process and magnetic materials. Excellent direct current characteristics and low DC resistance are realized by using magnetic materials which have excellent saturation characteristics and high permeability.

■ Features

1. LQM31F series is suitable for power line choke coils because of its excellent direct current characteristics and large rated current (70mA at 10 micro H).
2. Low DC resistance is realized.
3. The crosstalk characteristics are excellent because of magnetically shielded structure.
4. Low profile 1.0mm
5. Applicable soldering methods are both flow soldering and reflow soldering.

■ Applications

Circuits for DC power line choke of telecommunications equipment such as PDAs, Note-PCs, DSC, MD and DVD-RAM

■ Dimensions

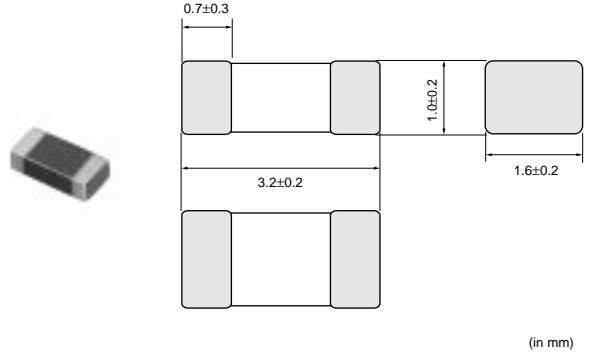

■ Rated Value (□: packaging code)

Part Number	Inductance	Test Frequency	Rated Current	Max. of DC Resistance	Self Resonance Frequency (min.)
LQM31FN100M00□	10μH±20%	1MHz	70mA	0.50ohm	20MHz

Operating Temperature Range: -40°C to +85°C

■ Impedance - Frequency Characteristics

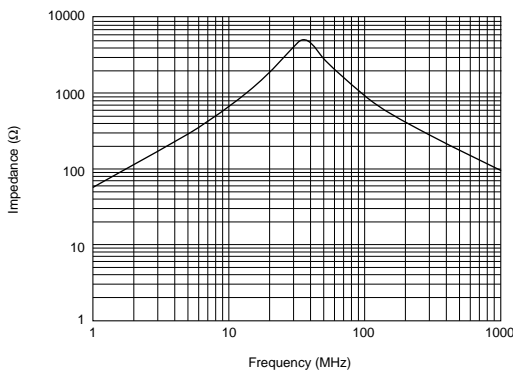

■ Inductance - Current Characteristics

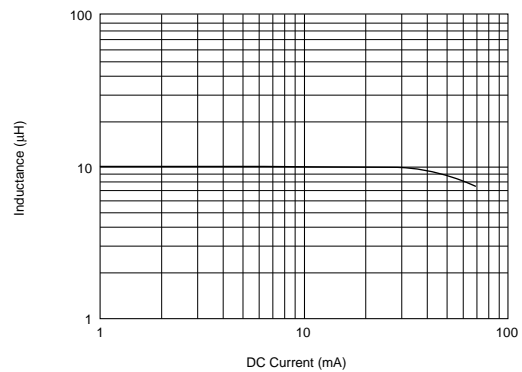

Chip Coils for Choke Wire Wound Type



LQH31C Series (1206 Size)

■ Features

LQH31C series consists of miniature chip inductors with low DC resistance, high current capacity, and high impedance characteristics. It is suitable for use as choke coils in DC power supply circuits. High rated current up to 970mA is available.

■ Dimensions

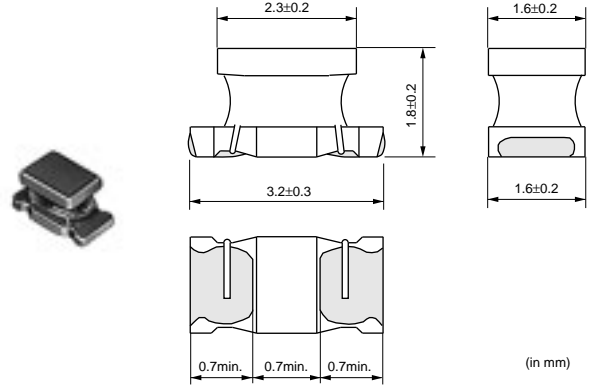

■ Rated Value (□: packaging code)

Part Number	Inductance	Test Frequency	Rated Current	DC Resistance	Self Resonance Frequency (min.)
LQH31CNR12M03□	0.12μH±20%	1MHz	970mA	0.08ohm±40%	250MHz
LQH31CNR22M03□	0.22μH±20%	1MHz	850mA	0.1ohm±40%	250MHz
LQH31CNR47M03□	0.47μH±20%	1MHz	700mA	0.15ohm±40%	180MHz
LQH31CN1R0M03□	1.0μH±20%	1MHz	510mA	0.28ohm±30%	100MHz
LQH31CN2R2M03□	2.2μH±20%	1MHz	430mA	0.41ohm±30%	50MHz
LQH31CN4R7M03□	4.7μH±20%	1MHz	340mA	0.65ohm±30%	31MHz
LQH31CN100K03□	10μH±10%	1MHz	230mA	1.3ohm±30%	20MHz
LQH31CN220K03□	22μH±10%	1MHz	160mA	3.0ohm±30%	14MHz
LQH31CN470K03□	47μH±10%	1MHz	100mA	8.0ohm±30%	10MHz
LQH31CN101K03□	100μH±10%	1MHz	80mA	12ohm±30%	7MHz

Operating Temperature Range: -40°C to +85°C

■ Impedance - Frequency Characteristics (Typ.)

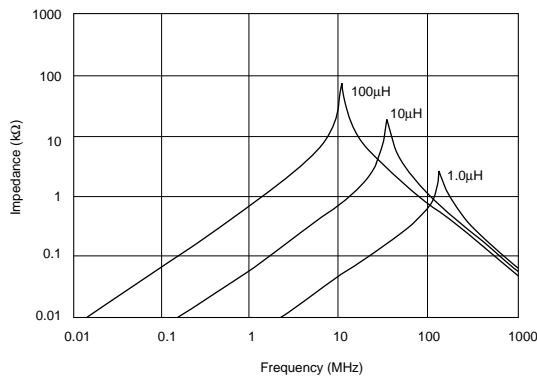

■ Inductance - Current Characteristics (Typ.)

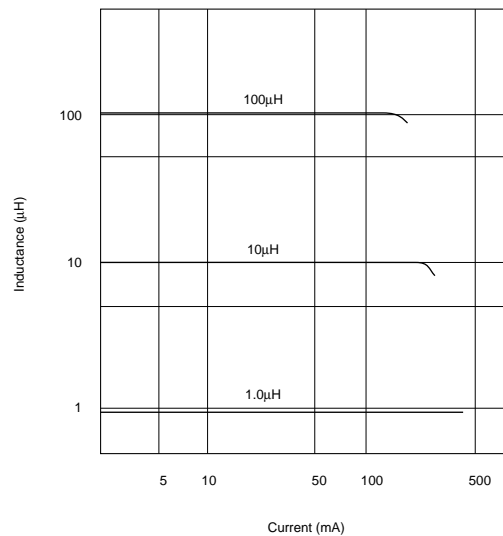

Chip Coils for Choke Wire Wound Type



LQH32C_23/LQH32C_33 Series (1210 Size)

LQH32C_23/_33 series consists of miniature chip coils with low DC resistance, high current capacity, and high inductance characteristics. These features are made possible by the development of Murata's innovative automatic wire wound techniques.

■ Dimensions

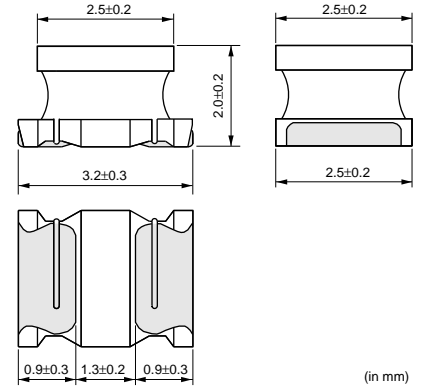

■ Features

1. Low DC resistance, high rated current and high inductance. Inductance: 0.15 to 560 micro H.
2. The series exhibits low voltage drops and small variations in inductance with respect to temperature rise and DC current level. This makes them excellent for use as power supply line choke coils.
3. The series has excellent solder heat resistance. Both flow and reflow soldering methods can be employed.

LQH32C_23 Series

■ Rated Value (□: packaging code)

Part Number	Inductance	Test Frequency	Rated Current	DC Resistance	Self Resonance Frequency (min.)
LQH32CN1R0M23□	1.0μH±20%	1MHz	800mA	0.09ohm±30%	96MHz
LQH32CN2R2M23□	2.2μH±20%	1MHz	600mA	0.13ohm±30%	64MHz
LQH32CN4R7M23□	4.7μH±20%	1MHz	450mA	0.2ohm±30%	43MHz
LQH32CN100K23□	10μH±10%	1MHz	300mA	0.44ohm±30%	26MHz
LQH32CN220K23□	22μH±10%	1MHz	250mA	0.71ohm±30%	19MHz
LQH32CN470K23□	47μH±10%	1MHz	170mA	1.3ohm±30%	15MHz
LQH32CN101K23□	100μH±10%	1MHz	100mA	3.5ohm±30%	10MHz
LQH32CN221K23□	220μH±10%	1MHz	70mA	8.4ohm±30%	6.8MHz
LQH32CN331K23□	330μH±10%	1MHz	60mA	10ohm±30%	5.6MHz
LQH32CN391K23□	390μH±10%	1MHz	60mA	17ohm±30%	5MHz
LQH32CN471K23□	470μH±10%	1kHz	60mA	19ohm±30%	5MHz
LQH32CN561K23□	560μH±10%	1kHz	60mA	22ohm±30%	5MHz

Operating Temperature Range: -40°C to +85°C

LQH32C_33 Series (Low DC Resistance Type)

■ Rated Value (□: packaging code)

Part Number	Inductance	Test Frequency	Rated Current	DC Resistance	Self Resonance Frequency (min.)
LQH32CNR15M33□	0.15μH±20%	1MHz	1450mA	0.028ohm±30%	400MHz
LQH32CNR27M33□	0.27μH±20%	1MHz	1250mA	0.034ohm±30%	250MHz
LQH32CNR47M33□	0.47μH±20%	1MHz	1100mA	0.042ohm±30%	150MHz
LQH32CN1R0M33□	1.0μH±20%	1MHz	1000mA	0.06ohm±30%	100MHz
LQH32CN2R2M33□	2.2μH±20%	1MHz	790mA	0.097ohm±30%	64MHz
LQH32CN4R7M33□	4.7μH±20%	1MHz	650mA	0.15ohm±30%	43MHz
LQH32CN100K33□	10μH±10%	1MHz	450mA	0.3ohm±30%	26MHz

Operating Temperature Range: -40°C to +85°C

■ Impedance - Frequency Characteristics (Typ.)

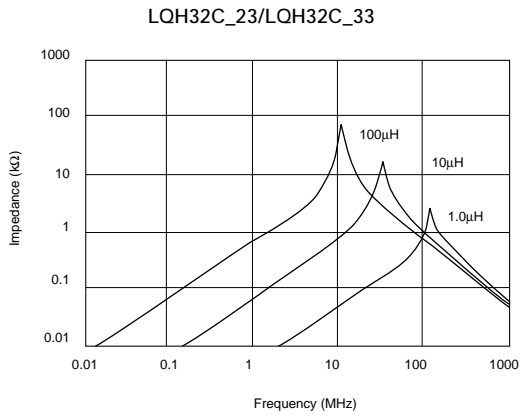

■ Inductance - Current Characteristics (Typ.)

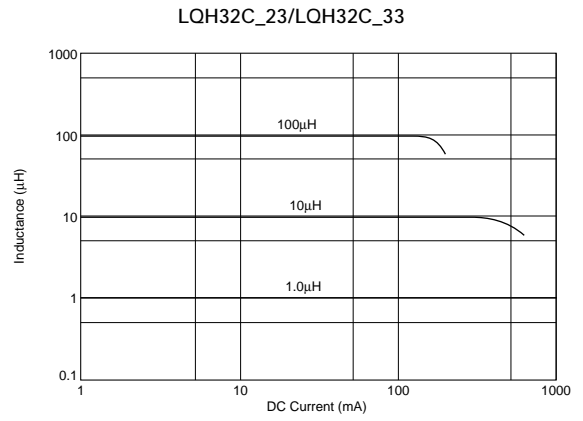

Chip Coils for Choke Wire Wound Type



LQH32C_53 Series (1210 Size)

LQH32C_53 series consists of miniature chip coils with low DC resistance, high current capacity, and high inductance characteristics. These features are made possible by the development of Murata's innovative wire wound techniques. They are excellent for use as choke coils in DC power supply circuits. The LQH32C_53 series has achieved Max 1.7mm height and high rated current.

■ Dimensions

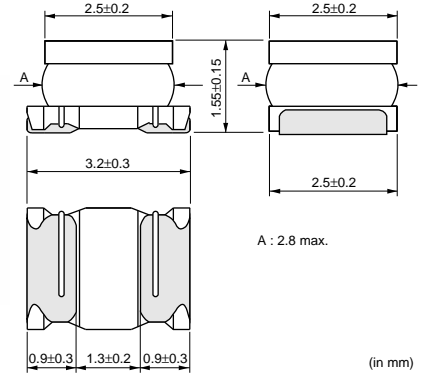

■ Features

1. The series has a wide inductance range of 1.0 to 100 micro H.
2. The series exhibits low voltage drops and small variations in inductance with respect to temperature rise and DC current level. This makes them excellent for use as power supply line choke coils.
3. The series has excellent solder heat resistance. Both flow and reflow soldering methods can be employed.

■ Rated Value (□: packaging code)

Part Number	Inductance	Test Frequency	Rated Current	DC Resistance	Self Resonance Frequency (min.)
LQH32CN1R0M53□	1.0μH±20%	1MHz	1000mA	0.060ohm±30%	100MHz
LQH32CN2R2M53□	2.2μH±20%	1MHz	790mA	0.097ohm±30%	64MHz
LQH32CN3R3M53□	3.3μH±20%	1MHz	710mA	0.12ohm±30%	50MHz
LQH32CN4R7M53□	4.7μH±20%	1MHz	650mA	0.15ohm±30%	43MHz
LQH32CN6R8M53□	6.8μH±20%	1MHz	540mA	0.25ohm±30%	32MHz
LQH32CN100K53□	10μH±10%	1MHz	450mA	0.30ohm±30%	26MHz
LQH32CN150K53□	15μH±10%	1MHz	300mA	0.58ohm±30%	26MHz
LQH32CN220K53□	22μH±10%	1MHz	250mA	0.71ohm±30%	19MHz
LQH32CN330K53□	33μH±10%	1MHz	200mA	1.1ohm±30%	17MHz
LQH32CN470K53□	47μH±10%	1MHz	170mA	1.3ohm±30%	15MHz
LQH32CN680K53□	68μH±10%	1MHz	130mA	2.2ohm±30%	12MHz
LQH32CN101K53□	100μH±10%	1MHz	100mA	3.5ohm±30%	10MHz

Operating Temperature Range: -40°C to +85°C

■ Impedance - Frequency Characteristics (Typ.)

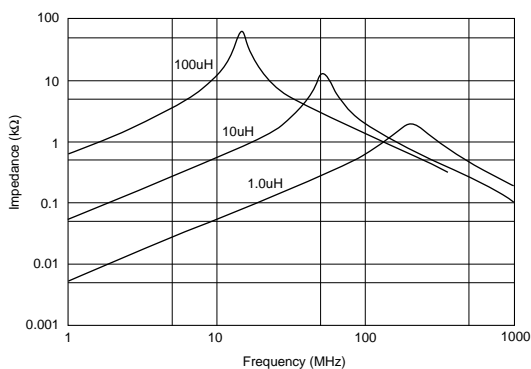

■ Inductance - Current Characteristics (Typ.)

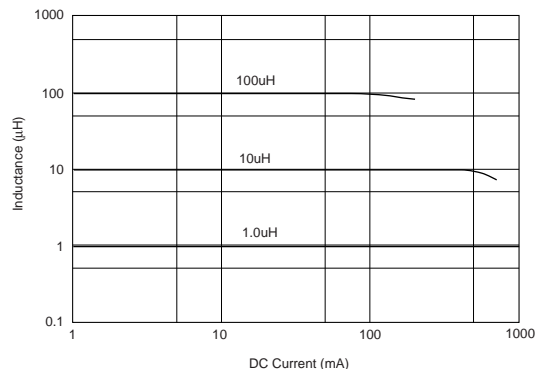

Chip Coils for Choke Wire Wound Type



LQH43C Series (1812 Size)

LQH43C series consists of miniature chip inductors with low DC resistance, high current capacity, and high impedance characteristics. It is suitable for use as choke coils in DC power supply circuits.

■ Features

1. Various inductance ranges are available.
2. The series exhibits low voltage drops and small change in inductance with respect to temperature rise and DC current level. This makes them excellent to use as power supply line choke coils.
3. Small size 4.5x3.2mm and realized low height 2.8mm max.
4. The series has excellent solder heat resistance. Both flow and reflow soldering methods can be employed.

■ Dimensions

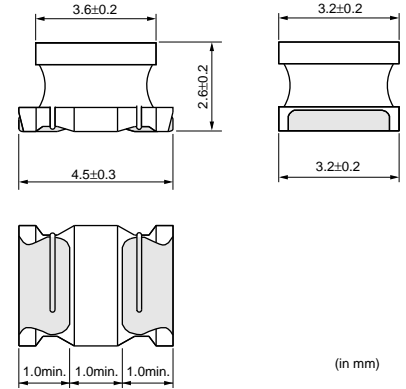

■ Rated Value (□: packaging code)

Part Number	Inductance	Test Frequency	Rated Current	Max. of DC Resistance	Self Resonance Frequency (min.)
LQH43CN1R0M03□	1.0μH±20%	1MHz	1080mA	0.08ohm	100MHz
LQH43CN1R5M03□	1.5μH±20%	1MHz	1000mA	0.09ohm	85MHz
LQH43CN2R2M03□	2.2μH±20%	1MHz	900mA	0.11ohm	60MHz
LQH43CN3R3M03□	3.3μH±20%	1MHz	800mA	0.13ohm	47MHz
LQH43CN4R7M03□	4.7μH±20%	1MHz	750mA	0.15ohm	35MHz
LQH43CN6R8M03□	6.8μH±20%	1MHz	720mA	0.20ohm	30MHz
LQH43CN100K03□	10μH±10%	1MHz	650mA	0.24ohm	23MHz
LQH43CN150K03□	15μH±10%	1MHz	570mA	0.32ohm	20MHz
LQH43CN220K03□	22μH±10%	1MHz	420mA	0.6ohm	15MHz
LQH43CN330K03□	33μH±10%	1MHz	310mA	1.0ohm	12MHz
LQH43CN470K03□	47μH±10%	1MHz	280mA	1.1ohm	10MHz
LQH43CN680K03□	68μH±10%	1MHz	220mA	1.7ohm	8.4MHz
LQH43CN101K03□	100μH±10%	1MHz	190mA	2.2ohm	6.8MHz
LQH43CN151K03□	150μH±10%	1MHz	130mA	3.5ohm	5.5MHz
LQH43CN221K03□	220μH±10%	1MHz	110mA	4.0ohm	4.5MHz
LQH43CN331K03□	330μH±10%	1MHz	100mA	6.8ohm	3.6MHz
LQH43CN471K03□	470μH±10%	1kHz	90mA	8.5ohm	3.0MHz

Operating Temperature Range: -40°C to +85°C

■ Impedance - Frequency Characteristics (Typ.)

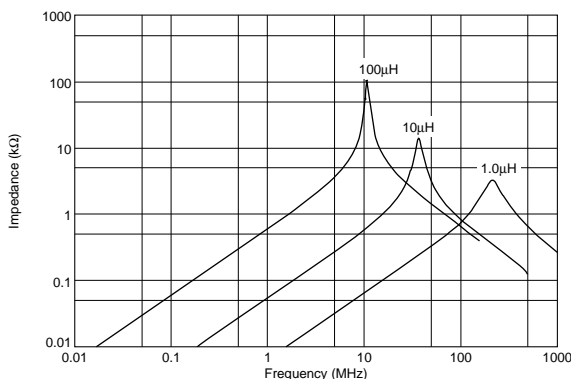

■ Inductance - Current Characteristics (Typ.)

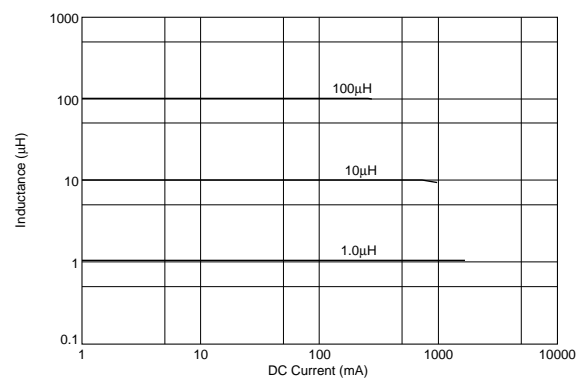

Chip Coils for Choke Large Current Type



LQH55D Series (2220 Size)

LQH55D series is wire wound type coils for choke by using high performance thick wire wound technology.

■ Dimensions

■ Features

1. Low direct current resistance, large current capacity and large inductance
2. For DC-DC converters and DC power supply circuits

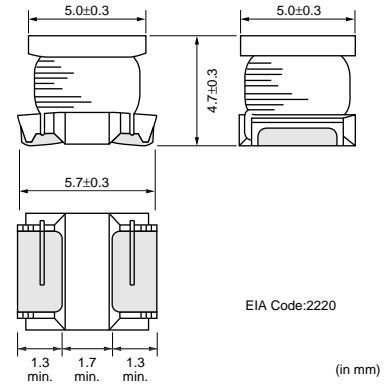

■ Rated Value (□: packaging code)

Part Number	Inductance	Test Frequency	Rated Current	DC Resistance	Self Resonance Frequency (min.)
LQH55DNR12M03□	0.12μH±20%	1MHz	6000mA	0.007ohm±40%	450MHz
LQH55DNR27M03□	0.27μH±20%	1MHz	5300mA	0.010ohm±40%	300MHz
LQH55DNR47M03□	0.47μH±20%	1MHz	4800mA	0.013ohm±40%	200MHz
LQH55DN1R0M03□	1.0μH±20%	1MHz	4000mA	0.019ohm±40%	150MHz
LQH55DN1R5M03□	1.5μH±20%	1MHz	3700mA	0.022ohm±40%	110MHz
LQH55DN2R2M03□	2.2μH±20%	1MHz	3200mA	0.029ohm±40%	80MHz
LQH55DN3R3M03□	3.3μH±20%	1MHz	2900mA	0.036ohm±40%	40MHz
LQH55DN4R7M03□	4.7μH±20%	1MHz	2700mA	0.041ohm±40%	30MHz
LQH55DN6R8M03□	6.8μH±20%	1MHz	2000mA	0.074ohm±40%	25MHz
LQH55DN100M03□	10μH±20%	1MHz	1700mA	0.093ohm±40%	20MHz
LQH55DN150M03□	15μH±20%	1MHz	1400mA	0.15ohm±40%	17MHz
LQH55DN220M03□	22μH±20%	1MHz	1200mA	0.19ohm±40%	15MHz
LQH55DN330M03□	33μH±20%	1MHz	900mA	0.32ohm±40%	12MHz
LQH55DN470M03□	47μH±20%	1MHz	800mA	0.40ohm±40%	10MHz
LQH55DN680M03□	68μH±20%	1MHz	640mA	0.67ohm±40%	7.6MHz
LQH55DN101M03□	100μH±20%	100kHz	560mA	0.86ohm±40%	6.5MHz
LQH55DN151M03□	150μH±20%	100kHz	420mA	1.9ohm±40%	5.0MHz
LQH55DN221M03□	220μH±20%	100kHz	320mA	2.4ohm±40%	4.0MHz
LQH55DN331M03□	330μH±20%	100kHz	270mA	4.4ohm±40%	3.1MHz
LQH55DN471M03□	470μH±20%	100kHz	240mA	5.4ohm±40%	2.4MHz
LQH55DN681M03□	680μH±20%	100kHz	190mA	8.1ohm±40%	1.9MHz
LQH55DN102M03□	1000μH±20%	10kHz	150mA	10.3ohm±40%	1.7MHz
LQH55DN222M03□	2200μH±20%	10kHz	100mA	21.5ohm±40%	1.2MHz
LQH55DN472M03□	4700μH±20%	10kHz	70mA	43.6ohm±40%	0.8MHz
LQH55DN103M03□	10000μH±20%	10kHz	50mA	100ohm±40%	0.5MHz

Operating Temperature Range: -40°C to +80°C Only for reflow soldering.

■ Impedance - Frequency Characteristics (Typ.)

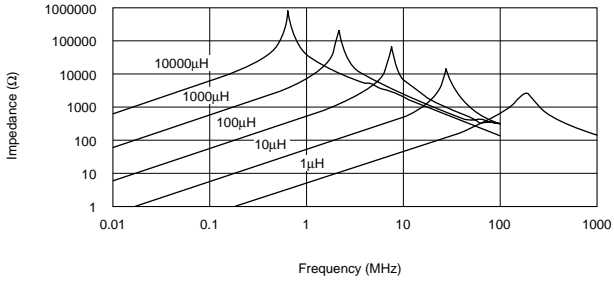

■ Inductance - Current Characteristics (Typ.)

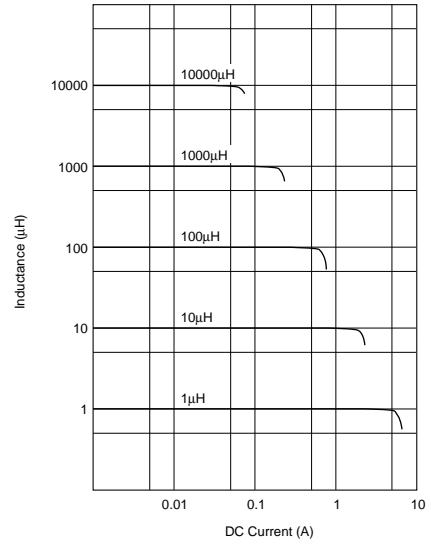

Chip Coils for Choke Large Current Type



LQH66S Series (2525 Size)

LQH66S series is magnetic shielded type coils for choke by using high performance thick wire wound technology.

■ Features

1. Low direct current resistance, large current capacity and large inductance
2. High density mounting
3. For DC-DC converters and DC power supply circuits

■ Dimensions

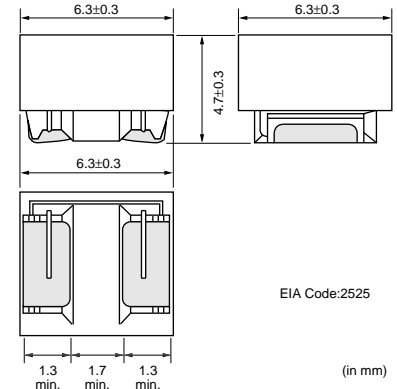

■ Rated Value (□: packaging code)

Part Number	Inductance	Test Frequency	Rated Current	DC Resistance	Self Resonance Frequency (min.)
LQH66SNR27M03□	0.27μH±20%	1MHz	6000mA	0.007ohm±40%	300MHz
LQH66SNR68M03□	0.68μH±20%	1MHz	5300mA	0.010ohm±40%	180MHz
LQH66SN1R0M03□	1.0μH±20%	1MHz	4700mA	0.013ohm±40%	150MHz
LQH66SN1R5M03□	1.5μH±20%	1MHz	3800mA	0.016ohm±40%	110MHz
LQH66SN2R2M03□	2.2μH±20%	1MHz	3300mA	0.019ohm±40%	80MHz
LQH66SN3R3M03□	3.3μH±20%	1MHz	2600mA	0.022ohm±40%	40MHz
LQH66SN4R7M03□	4.7μH±20%	1MHz	2200mA	0.025ohm±40%	30MHz
LQH66SN6R8M03□	6.8μH±20%	1MHz	1800mA	0.029ohm±40%	25MHz
LQH66SN100M03□	10μH±20%	1MHz	1600mA	0.036ohm±40%	20MHz
LQH66SN150M03□	15μH±20%	1MHz	1300mA	0.069ohm±40%	17MHz
LQH66SN220M03□	22μH±20%	1MHz	1100mA	0.087ohm±40%	15MHz
LQH66SN330M03□	33μH±20%	1MHz	860mA	0.14ohm±40%	12MHz
LQH66SN470M03□	47μH±20%	1MHz	760mA	0.17ohm±40%	10MHz
LQH66SN680M03□	68μH±20%	1MHz	600mA	0.29ohm±40%	7.6MHz
LQH66SN101M03□	100μH±20%	100kHz	520mA	0.36ohm±40%	6.5MHz
LQH66SN151M03□	150μH±20%	100kHz	420mA	0.63ohm±40%	5.0MHz
LQH66SN221M03□	220μH±20%	100kHz	350mA	0.79ohm±40%	4.0MHz
LQH66SN331M03□	330μH±20%	100kHz	280mA	1.8ohm±40%	3.2MHz
LQH66SN471M03□	470μH±20%	100kHz	240mA	2.2ohm±40%	2.5MHz
LQH66SN681M03□	680μH±20%	100kHz	200mA	3.9ohm±40%	2.0MHz
LQH66SN102M03□	1000μH±20%	10kHz	160mA	4.9ohm±40%	1.7MHz
LQH66SN222M03□	2200μH±20%	10kHz	100mA	9.4ohm±40%	1.2MHz
LQH66SN472M03□	4700μH±20%	10kHz	70mA	19.5ohm±40%	0.8MHz
LQH66SN103M03□	10000μH±20%	10kHz	50mA	39.7ohm±40%	0.5MHz

Operating Temperature Range: -40°C to +80°C Only for reflow soldering.

■ Impedance - Frequency Characteristics (Typ.)

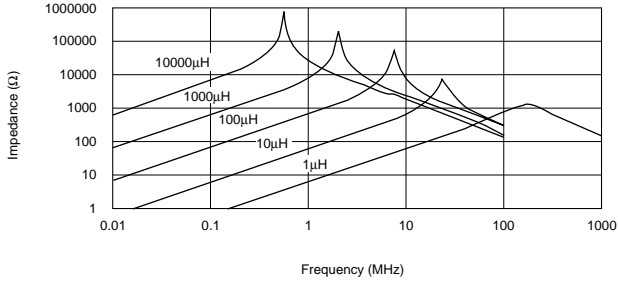

■ Inductance - Current Characteristics (Typ.)

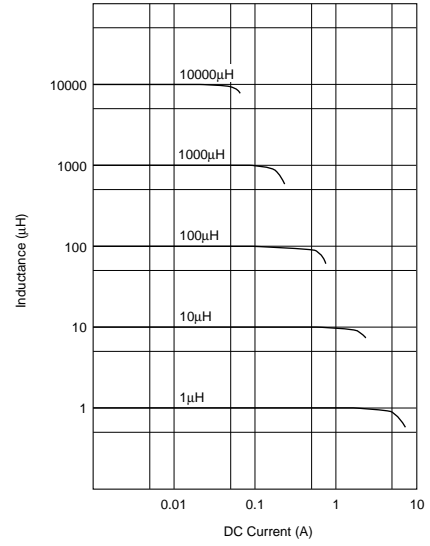

⚠ Caution/Notice

■ ⚠ Caution (Rating)

Do not use products beyond the rated current as this may create excessive heat.

■ Notice (Storage and Operating Condition)

<Operating Environment>

Do not use products in chemical atmosphere such as chlorine gas, acid or sulfide gas.

<Storage Requirements>

1. Storage Period

LQG/LQM series should be used within 6 months; the other products should be used within 12 months.

Check solderability if this period is exceeded.

2. Storage Conditions

(1) Store products in a warehouse in compliance with the following conditions:

Temperature: -10 to 40 degrees C.

Humidity: 30 to 70% (relative humidity)

Do not subject products to rapid changes in temperature and humidity.

Do not store them in chemical atmosphere such as one containing sulfurous acid gas or alkaline gas.

This will prevent electrode oxidation which causes poor solderability and possible corrosion of coils.

(2) Do not store products in bulk packaging to prevent collision among coils which causes core chipping and wire breakage.

(3) Store products on pallets to protect from humidity, dust, etc.

(4) Avoid heat shock, vibration, direct sunlight, etc.

■ Notice (Handling)

This item is designed to have sufficient strength, but handle with care to avoid chipping or breaking its ceramic structure.

LQW_A series/ LQW_H series

- To prevent breaking the wire, avoid touching sharp material, such as tweezers, to the wire wound portion.
- To prevent breaking the core, avoid applying excessive mechanical shock to products mounted on the board.
- In some mounting machines, when picking up components, support pin pushes up the components from the bottom of base tape. In this case, please remove the support pin. The support pin may damage the components and break wire.
- In rare case, the laser recognition can not recognize this component. Please contact us when you use laser recognition. (There is no problem with the permeation and reflection type.)

LQH_C/D/H/M/N/P series

- To prevent breaking the wire, avoid touching sharp material, such as tweezers, to the wire wound portion.
- To prevent breaking the core, avoid applying excessive mechanical shock to products mounted on the board.
- Temperature may rise up to max. 40 °C when applying the rated current to LQH3NP. Be careful of the temperature rating of the circuit board and components around the chip coil.

LQG,LQP series (except LQP02T_02/LQP03T_02)

- The pattern of the chip coil is covered with protective film. Take care to avoid damaging the chip coil when handling it with pick-up nozzles, sharp instruments, etc.

LQM series

- There is the possibility that magnetism may change

the inductance value. Do not use a magnet or tweezers with magnetism when handling chip coils. (The tip of the tweezers should be molded with resin or pottery.)

- When the excessive current over rated current is applied, it may cause the inductance value to change due to magnetism.

<Handling>

1. Avoid applying excessive stress to products to prevent damage.
2. Do not touch wire wound with sharp objects such as tweezers to prevent wire breakage.
3. Do not apply excessive force to products mounted on boards to prevent core breakage.

<Transportation>

Do not apply excessive vibration or mechanical shock to products.

<Resin Coating>

When coating products with resin, the relatively high resin curing stress may change inductance values.

For exterior coating, select resin carefully so that electrical and mechanical performance of the product is not affected. Prior to use, please evaluate reliability with the product mounted in your application set.

(LQW,LQH series)

An open circuit issue may occur by mechanical stress caused by the resin, amount/cured shape of resin, or operating condition etc. Some resins containing impurities or chloride may possibly generate chlorine by hydrolysis under some operating condition may cause corrosion of wire of coil, leading to open circuit.

(LQP02T_02,LQP03T_02)

When products are coated with resin, please contact us in advance.

Caution/Notice

Notice (Measuring Method)

Measuring Method of Inductance/Q

1. Residual elements and stray elements of test fixture can be described by F-parameter as shown in the following:

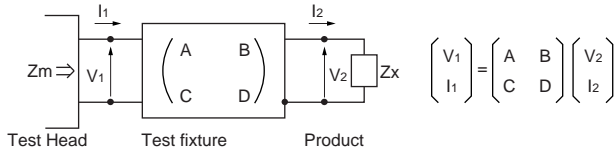

2. The impedance of chip coil Z_x and measured value Z_m can be described by input/output current/voltage.

$$Z_m = \frac{V_1}{I_1}, \quad Z_x = \frac{V_2}{I_2}$$

3. Thus, the relation between Z_x and Z_m is shown in the following:

$$Z_x = \alpha \frac{Z_m - \beta}{1 - Z_m \Gamma} \quad \text{where, } \alpha = D / A = 1$$

$$\beta = B / D = Z_{sm} - (1 - Y_{om} Z_{sm}) Z_{ss}$$

$$\Gamma = C / A = Y_{om}$$

$\left[\begin{array}{l} Z_{sm}: \text{measured impedance of short chip} \\ Z_{ss}: \text{residual impedance of short chip}^* \\ Y_{om}: \text{measured admittance when opening the fixture} \end{array} \right]$

***Residual impedance of short chip**

Residual Impedance	Series
0nH	LQG15HS
0.110nH	LQP02T
0.430nH	LQP03T_00/_04
0.464nH	LQW04A
0.480nH	LQP03T_02
0.556nH	LQG15HN, LQW15A, LQP15T/M
0.771nH	LQG18H, LQP18M, LQW18A, LQW21H

4. L_x and Q_x should be calculated with the following equation.

$$L_x = \frac{\text{Im}(Z_x)}{2\pi f}, \quad Q_x = \frac{\text{Im}(Z_x)}{\text{Re}(Z_x)}$$

L_x : Inductance of chip coil
 Q_x : Q of chip coil
 f : Measuring frequency

Chip Coils (Soldering and Mounting)

1. Standard Land Dimensions

A high Q value is achieved when the PCB electrode land pattern is designed so that it does not project beyond the chip coil electrode.



Series	Standard Land Dimensions																																																																																						
LQG15H LQG18H LQM18N/18F LQM21N/21D/21F/21P LQM2HP LQM2MP LQM31F LQM31P LQP02T LQP03T LQP15M/15T LQP18M LQH2MC LQH32P LQW04A LQW15A LQW18A LQW21H LQW2BH LQW31H LQH31M/31C/31H	<table border="1"> <thead> <tr> <th>Part Number</th> <th>a</th> <th>b</th> <th>c</th> </tr> </thead> <tbody> <tr> <td>LQG15H</td> <td>0.5-0.6</td> <td>1.4-1.5</td> <td>0.4</td> </tr> <tr> <td>LQG18H</td> <td>0.6-0.8</td> <td>1.8-2.2</td> <td>0.6-0.8</td> </tr> <tr> <td rowspan="2">LQM18N/18F</td> <td rowspan="2">0.7</td> <td>Flow</td> <td>2.2-2.6</td> </tr> <tr> <td>Reflow</td> <td>1.8-2.0</td> </tr> <tr> <td>LQM21N/21D/21F/21P</td> <td>1.0</td> <td>3.0-4.0</td> <td>1.2</td> </tr> <tr> <td>LQM2HP</td> <td>1.5</td> <td>3.0</td> <td>1.6</td> </tr> <tr> <td>LQM2MP</td> <td>1.8</td> <td>2.4</td> <td>0.8</td> </tr> <tr> <td>LQM31F/31P</td> <td>1.2</td> <td>4.2-5.2</td> <td>2.0</td> </tr> <tr> <td>LQP02T</td> <td>0.2-0.23</td> <td>0.4-0.56</td> <td>0.16-0.2</td> </tr> <tr> <td>LQP03T</td> <td>0.2-0.3</td> <td>0.8-0.9</td> <td>0.2-0.3</td> </tr> <tr> <td>LQP15M/15T</td> <td>0.5-0.6</td> <td>1.4-1.5</td> <td>0.4</td> </tr> <tr> <td>LQP18M</td> <td>0.7-0.9</td> <td>1.8-2.2</td> <td>0.6-0.8</td> </tr> <tr> <td>LQH2MC</td> <td>1.0</td> <td>2.6</td> <td>0.8</td> </tr> <tr> <td>LQH32P</td> <td>2.0</td> <td>3.8</td> <td>1.3</td> </tr> <tr> <td>LQW04A</td> <td>0.40</td> <td>1.0</td> <td>0.40</td> </tr> <tr> <td>LQW15A</td> <td>0.65</td> <td>1.2</td> <td>0.50</td> </tr> <tr> <td>LQW18A</td> <td>0.7-1.0</td> <td>1.8-2.0</td> <td>0.6-0.8</td> </tr> <tr> <td>LQW21H</td> <td>1.2</td> <td>2.6</td> <td>1.0</td> </tr> <tr> <td>LQW2BH</td> <td>1.2</td> <td>3.0</td> <td>0.8</td> </tr> <tr> <td>LQH31M/31C/31H</td> <td>1.5</td> <td>4.5</td> <td>1.0</td> </tr> <tr> <td>LQW31H</td> <td></td> <td></td> <td></td> </tr> </tbody> </table>	Part Number	a	b	c	LQG15H	0.5-0.6	1.4-1.5	0.4	LQG18H	0.6-0.8	1.8-2.2	0.6-0.8	LQM18N/18F	0.7	Flow	2.2-2.6	Reflow	1.8-2.0	LQM21N/21D/21F/21P	1.0	3.0-4.0	1.2	LQM2HP	1.5	3.0	1.6	LQM2MP	1.8	2.4	0.8	LQM31F/31P	1.2	4.2-5.2	2.0	LQP02T	0.2-0.23	0.4-0.56	0.16-0.2	LQP03T	0.2-0.3	0.8-0.9	0.2-0.3	LQP15M/15T	0.5-0.6	1.4-1.5	0.4	LQP18M	0.7-0.9	1.8-2.2	0.6-0.8	LQH2MC	1.0	2.6	0.8	LQH32P	2.0	3.8	1.3	LQW04A	0.40	1.0	0.40	LQW15A	0.65	1.2	0.50	LQW18A	0.7-1.0	1.8-2.0	0.6-0.8	LQW21H	1.2	2.6	1.0	LQW2BH	1.2	3.0	0.8	LQH31M/31C/31H	1.5	4.5	1.0	LQW31H			
Part Number	a	b	c																																																																																				
LQG15H	0.5-0.6	1.4-1.5	0.4																																																																																				
LQG18H	0.6-0.8	1.8-2.2	0.6-0.8																																																																																				
LQM18N/18F	0.7	Flow	2.2-2.6																																																																																				
		Reflow	1.8-2.0																																																																																				
LQM21N/21D/21F/21P	1.0	3.0-4.0	1.2																																																																																				
LQM2HP	1.5	3.0	1.6																																																																																				
LQM2MP	1.8	2.4	0.8																																																																																				
LQM31F/31P	1.2	4.2-5.2	2.0																																																																																				
LQP02T	0.2-0.23	0.4-0.56	0.16-0.2																																																																																				
LQP03T	0.2-0.3	0.8-0.9	0.2-0.3																																																																																				
LQP15M/15T	0.5-0.6	1.4-1.5	0.4																																																																																				
LQP18M	0.7-0.9	1.8-2.2	0.6-0.8																																																																																				
LQH2MC	1.0	2.6	0.8																																																																																				
LQH32P	2.0	3.8	1.3																																																																																				
LQW04A	0.40	1.0	0.40																																																																																				
LQW15A	0.65	1.2	0.50																																																																																				
LQW18A	0.7-1.0	1.8-2.0	0.6-0.8																																																																																				
LQW21H	1.2	2.6	1.0																																																																																				
LQW2BH	1.2	3.0	0.8																																																																																				
LQH31M/31C/31H	1.5	4.5	1.0																																																																																				
LQW31H																																																																																							
LQH32M LQH32C																																																																																							
LQH3NP																																																																																							
LQH43M LQH43N LQH43C																																																																																							
LQH55D LQH66S																																																																																							

Attention should be paid to potential magnetic coupling effects when using the coil as a resonator.

Continued on the following page.

Chip Coils (Soldering and Mounting)

☐ Continued from the preceding page.

■ Land Pattern + Solder Resist
 ■ Land Pattern
 □ Solder Resist
 (in mm)

Series	Standard Land Dimensions
LQH55P	

Attention should be paid to potential magnetic coupling effects when using the coil as a resonator.

2. Standard Soldering Conditions

(1) Soldering method

Chip coils can be flow or reflow soldered.
 Please contact Murata regarding other soldering methods.
 As for LQG, LQP, LQW04A/15A/18A/21H, LQH2MC/55D/55P/66S/32P/3NP series, please use reflow soldering.

Flux: Use rosin-based flux, but not strongly acidic flux (with chlorine content exceeding 0.2wt%).
 Do not use water-soluble flux.

The flux used for LQW04/15/18/21 series should use the rosin-based flux that includes middle activator equivalent to 0.06wt% to 0.1wt% chlorine.

For additional mounting methods, please contact Murata.

Solder: Use H60A, H63A (JIS Z 3282) or equivalent.

Use solder paste equivalent to H60A for LQP03T/15M/15T/18M and LQG15H/18H.

In case of Lead-free solder, use Sn-3.0Ag-0.5Cu solder.

(2) Soldering profile

- Flow Soldering profile
 (Eutectic solder, Sn-3.0Ag-0.5Cu solder)

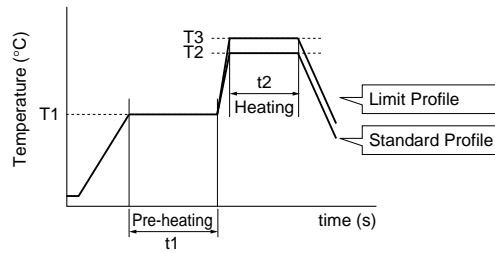

Series	Pre-heating		Standard Profile			Limit Profile		
	Temp. (T1)	Time. (t1)	Heating		Cycle of flow	Heating		Cycle of flow
			Temp. (T2)	Time. (t2)		Temp. (T3)	Time. (t2)	
LQM18N/18F LQM21N/21D/21F/21P/2HP/2MP LQM31F/31P LQW2BH/31H LQH31C/31H/31M	150°C	60s min.	250°C	4 to 6s	2 times max.	265±3°C	5s max.	2 times max.
LQH32C/32M LQH43C/43M(N)	150°C	60s min.	250°C	4 to 6s	2 times max.	265±3°C	5s max.	1 times

Continued on the following page. ☐ ↗

Chip Coils (Soldering and Mounting)

Continued from the preceding page.

● Reflow Soldering profile

① Soldering profile for Lead-free solder (Sn-3Ag-0.5Cu)

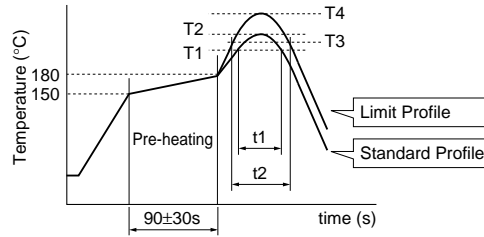

Series	Standard Profile				Limit Profile			
	Heating		Peak temperature (T2)	Cycle of reflow	Heating		Peak temperature (T4)	Cycle of reflow
	Temp. (T1)	Time. (t1)			Temp. (T3)	Time. (t2)		
LQG15H/18H LQW04A/15A/18A/21H LQP02T/03T/15M/15T/18M LQW2BH/31H LQM18N/18F LQM21N/21D/21F/21P/2HP/2MP LQM31F/31P, LQH2MC LQH31C/31H/31M LQH32P/3NP/55P	220°C	30 to 60s	245±3°C	2 times max.	230°C	60s max.	260°C/10s	2 times max.
LQH32C/32M LQH43C/43M(N) LQH55D, LQH66S	220°C	30 to 60s	245±3°C	2 times max.	230°C	60s max.	260°C/10s	1 time

② Soldering profile for Eutectic solder (Limit profile: refer to ①)

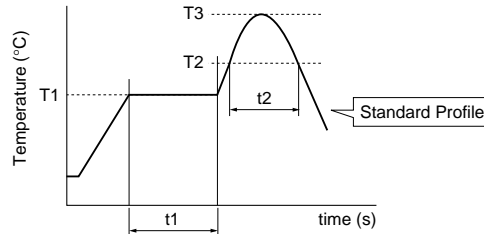

Series	Pre-heating		Standard Profile			
	Temp. (T1)	Time. (t1)	Heating		Peak temperature (T3)	Cycle of reflow
			Temp. (T2)	Time. (t2)		
LQG15H/18H LQW04A/15A/18A/21H LQP02T/03T/15T/15M/18M LQW2BH/31H LQH31H, LQM18N/18F LQM21N/21D/21F/21P/2HP/2MP LQM31F/31P, LQH2MC LQH31C, LQH32C LQH31M, LQH32M, LQH32P/3NP LQH43C, LQH43M(N) LQH55D LQH66S	150°C	60s min.	183°C	60s max.	230°C	2 times max.

Continued on the following page. ↗

Chip Coils (Soldering and Mounting)

☒ Continued from the preceding page.

- (3) Reworking with Soldering Iron *Except LQP02T Series
 Preheating at 150°C for 1 minute is required. Do not directly touch the ceramic element with the tip of the soldering iron. The reworking soldering conditions are as follows:

Soldering iron power output: 30W max.
 Temperature of soldering iron tip: 350°C
 Diameter of soldering iron end: 3.0mm max.
 Soldering time: within 3 s

3. Mounting Instructions

(1) Land Pattern Dimensions

Large lands reduce Q of the mounted chip. Also, large protruding land areas (bordered by lines having dimensions 'c' and 'd' shown) cause floating and electrode leaching.

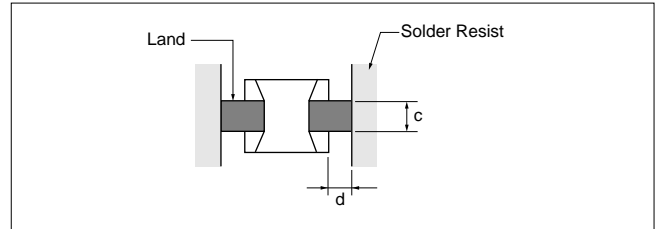

(2) Magnetic Coupling

Since some chip coils are constructed like an open magnetic circuit, narrow spacing between coils may cause magnetic coupling.

LQM, LQH66S and LQH32P/3NP series have a magnetically shielded structure. The structure makes their coupling coefficient smaller than that of conventional chip coils.

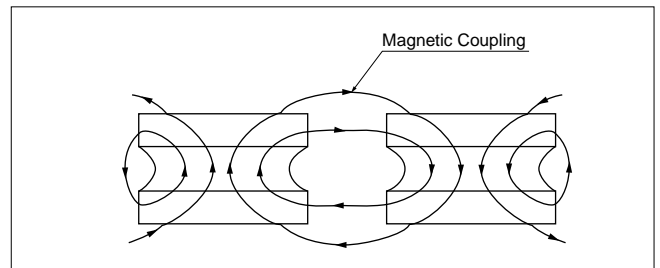

(3) PCB Warping

PCB should be designed so that products are not subjected to the mechanical stress caused by warping the board.

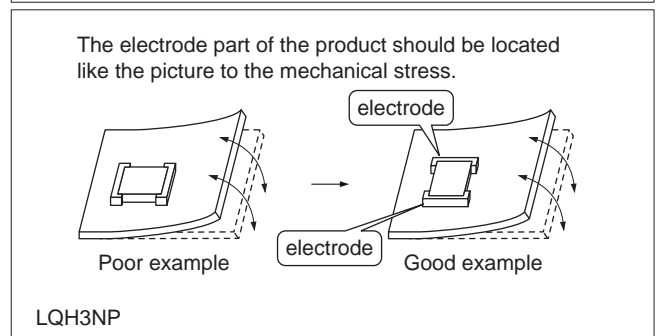
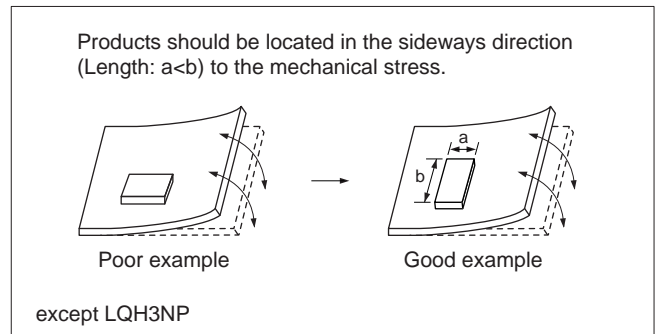

Continued on the following page. ☒

Chip Coils (Soldering and Mounting)

☒ Continued from the preceding page.

(4) Amount of Solder Paste

Excessive solder causes electrode corrosion, while insufficient solder causes low electrode bonding strength. Adjust the amount of solder paste as shown on the right so that solder is applied.

● Standard thickness of solder paste

LQP*, LQG, LQM, LQW15A/18A/21H, LQH2MC, LQH32P/3NP: 100 to 150 μ m (*LQP02T: 50 to 80 μ m)
 LQW04A: 80 to 100 μ m
 LQH*, LQW_H: 200 to 300 μ m (*LQH55P: 100 to 150 μ m)

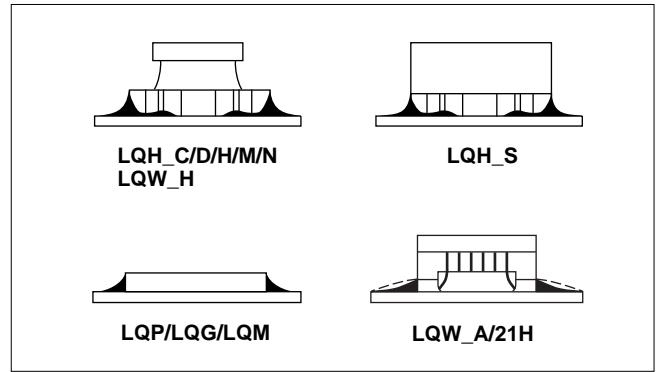

LQW15A Series:

Too much solder may cause slant or rotation of chip at the time of solder melting. Please reduce the amount of solder by using smaller solder area than land pattern, as shown in figure at right.

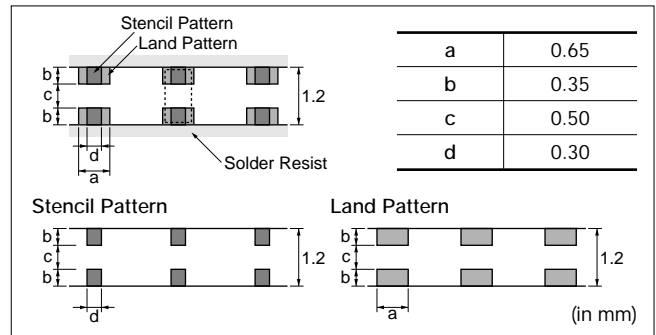

(5) Amount of Adhesive

If too much adhesive is applied, then it may overflow into the land or termination areas and yield poor solderability. In contrast, if insufficient adhesive is applied, or if the adhesive is not sufficiently hardened, then the chip may become detached during flow soldering. Apply the adhesive in accordance with the conditions shown in chart.

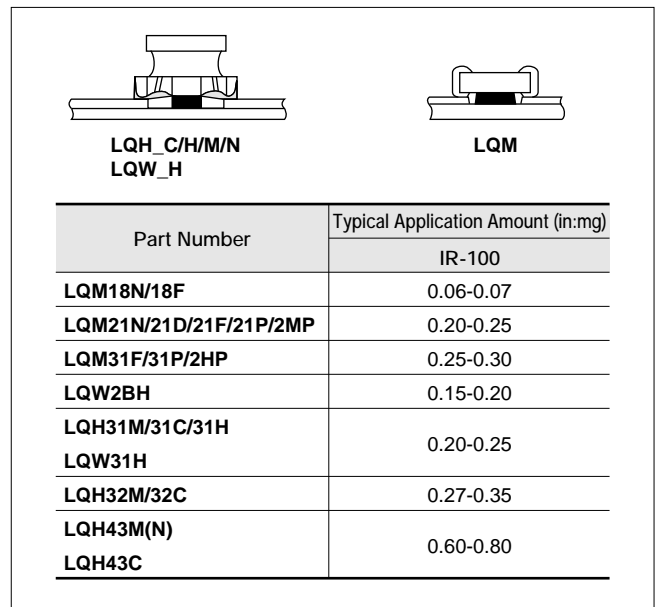

4. Cleaning

The following conditions should be observed when cleaning chip coils:

- (1) Cleaning Temperature: 60°C max. (40°C max. for alcohol cleaning agents)
- (2) Ultrasonic
 - Output: 20W/l max.
 - Duration: 5 minutes max.
 - Frequency: 28 to 40kHz
 - Care should be taken not to cause resonance of the PCB and mounted products.
- (3) Cleaning agent
 - The following cleaning agents have been tested on individual components. Evaluation in complete assembly should be done prior to production.

- (a) Alcohol cleaning agents
 - Isopropyl alcohol (IPA)
- (b) Aqueous cleaning agents
 - Pine Alpha ST-100S
 - LQH66S series: Aqueous agents should not be used because they may cause quality deterioration.
- (4) Ensure that flux residue is completely removed. Component should be thoroughly dried after aqueous agents have been removed with deionized water.

For additional cleaning methods, please contact Murata.

Packaging

Minimum Quantity and 8mm Width Taping Dimensions

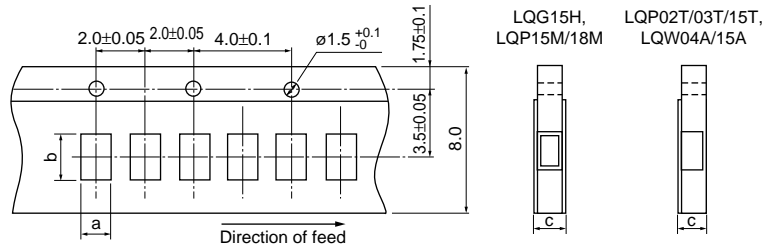

Paper Tape

Part Number	Dimensions		Total Thickness of Tape	Packaging Code (Minimum Qty. [pcs.])		
	a	b		c	ø180mm reel	ø330mm reel
LQG15H	0.62	1.12	0.8 max.	D [10000]	J [50000]	B [1000]
LQP02T	0.24	0.455	0.39 max.	D [10000]	-	B [500]
LQP03T_00/04	0.38	0.68	0.55 max.	D [10000]	J [50000]	B [500]
LQP03T_02	0.36	0.66	0.55 max.	D [10000]	J [50000]	B [500]
LQP15T	0.62	1.12	0.8 max.	D [10000]	-	B [500]
LQP15M	0.70	1.20	0.8 max.	D [10000]	J [50000]	B [500]
LQP18M	1.19	2.0	0.8 max.	D [4000]	J [10000]	B [500]
LQW04A	0.50	0.905	0.75 max.	D [10000]	-	B [500]
LQW15A_00 *1	0.64/0.66/0.69	1.18	0.8 max.	D [10000]	-	B [500]
LQW15A_10 *2	0.66/0.69	1.18	0.8 max.	D [10000]	-	B [500]

- *1 0.69 (1.5-2.7nH, 3.9-4.7nH, 5.8-6.8nH, 8.2-9.5nH, 11nH, 12nH, 15nH)
 0.66 (2.9nH, 5.1nH, 7.3nH, 7.5nH, 10nH, 13nH, 16-23nH, 100nH, 120nH)
 0.64 (24-91nH)
 *2 0.69 (1.3nH)
 0.66 (2.2-5.6nH)

(in mm)

Continued on the following page.

Packaging

Continued from the preceding page.

Minimum Quantity and 8mm Width Taping Dimensions

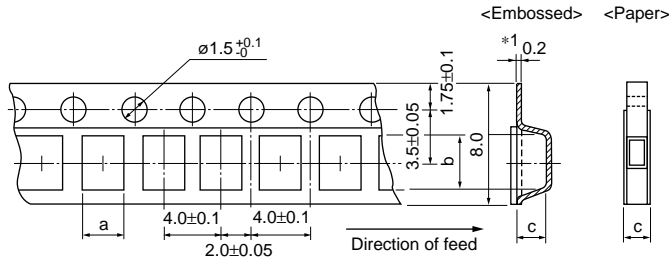

*1: 0.3 LQW2BH
0.25 LQM2HP/31P_00, LQH2, LQW21H

Paper Tape

Part Number	Dimensions		Total Thickness of Tape	Packaging Code (Minimum Qty. [pcs.])		
	a	b		c	ø180mm reel	ø330mm reel
LQM21N (0.1-2.2μH)	1.45	2.25	1.1 max.	D [4000]	J [10000]	B [1000]
LQM21D (1-10μH)	1.45	2.25	1.1 max.	D [4000]	J [10000]	B [1000]
LQM21F (1-2.2μH)	1.45	2.25	1.1 max.	D [4000]	J [10000]	B [1000]
LQM21P	1.45	2.25	0.8 max.	D [4000]	-	-
LQM31P_C0	1.8	3.4	0.8 max.	D [4000]	-	B [1000]
LQG18H	1.05	1.85	1.1 max.	D [4000]	J [10000]	B [1000]
LQM18N/18F	1.05	1.85	1.1 max.	D [4000]	J [10000]	B [1000]
LQW18A_00	1.0	1.8	1.1 max.	D [4000]	J [10000]	B [500]
LQW18A_10	1.1	1.9	1.1 max.	D [4000]	J [10000]	B [500]

Embossed Tape

Part Number	Dimensions		Depth of Cavity	Packaging Code (Minimum Qty. [pcs.])		
	a	b		c	ø180mm reel	ø330mm reel
LQM21N (2.7-4.7μH)	1.45	2.25	1.3	L [3000]	K [10000]	B [1000]
LQM21D (22-47μH)	1.45	2.25	1.3	L [3000]	K [10000]	B [1000]
LQM21F (4.7-47μH)	1.45	2.25	1.3	L [3000]	K [10000]	B [1000]
LQM2HP_J0	2.25	2.75	1.3	L [3000]	-	B [1000]
LQM2HP_G0	2.3	2.8	1.1	L [3000]	-	B [1000]
LQM2HP_E0	2.3	2.8	0.9	L [3000]	-	B [1000]
LQM2MP_G0	1.85	2.25	1.1	L [3000]	-	B [1000]
LQM31F	1.9	3.5	1.3	L [3000]	K [10000]	B [1000]
LQM31P_00	1.9	3.5	1.05	L [3000]	-	B [1000]
LQH31M/31C/31H, LQW31H	1.9	3.6	2.0	L [2000]	K [7500]	-
LQW21H	1.55	2.3	1.1	L [3000]	-	B [500]
LQW2BH	1.75	2.3	2.0	L [2000]	K [7500]	-
LQH32M, LQH32C_33/_23	2.9	3.6	2.1	L [2000]	K [7500]	-
LQH32C_53	2.9	3.6	1.7	L [2000]	K [7500]	-
LQH32P	2.9	3.6	1.7	L [2000]	K [7500]	-
LQH2MC_02	1.9	2.3	1.05	L [3000]	-	B [100]
LQH2MC_52	1.9	2.3	0.8	L [3000]	-	B [100]

(in mm)

Continued on the following page. ↗

Packaging

☐ Continued from the preceding page.

■ Minimum Quantity and 12mm Width Embossed Taping Dimensions

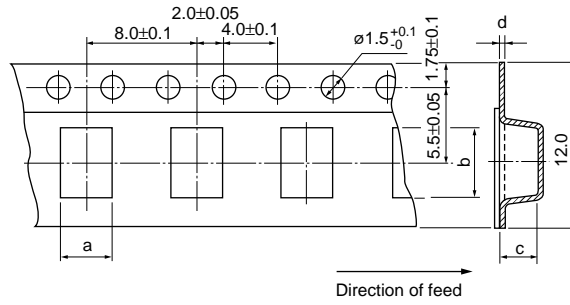

Embossed Tape

Part Number	Dimensions (*c: Depth of Cavity)				Packaging Code (Minimum Qty. [pcs.])		
	a	b	c	d	ø180mm reel	ø330mm reel	Bulk
LQH3NP_M0	3.3	3.3	1.6	0.25	L [1000]	K [4000]	-
LQH3NP_G0	3.3	3.3	1.1	0.25	L [1500]	K [6000]	-
LQH43M(N)	3.6	4.9	2.7	0.3	L [500]	K [2500]	-
LQH43C	3.6	4.9	2.7	0.3	L [500]	-	-
LQH55D	5.4	6.1	5.0	0.4	L [350]	K [1500]	-
LQH66S	6.7	6.7	5.6	0.4	L [350]	K [1500]	-

(in mm)

■ Minimum Quantity and 12mm Width Embossed Taping Dimensions

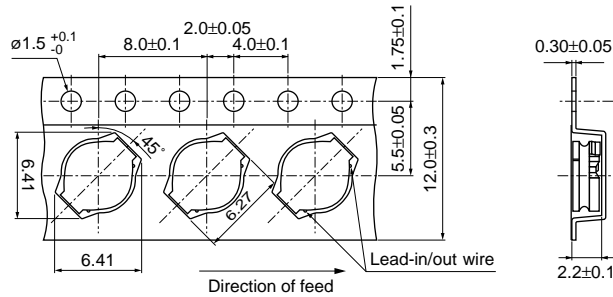

Embossed Tape

Part Number	Packaging Code (Minimum Qty. [pcs.])		
	ø180mm reel	ø330mm reel	Bulk
LQH55P	L [500]	K [3000]	-

(in mm)

Design Kits

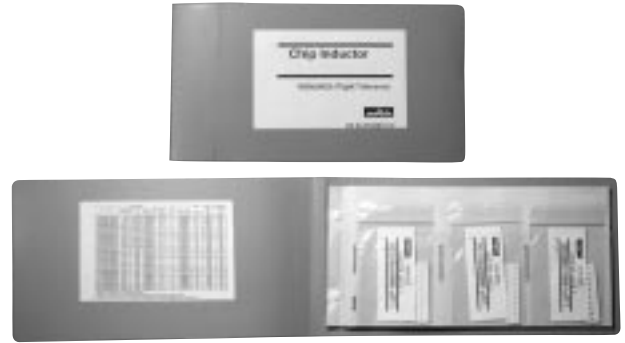

●EKLMQ15SC (High Frequency Monolithic Type)

No.	Part Number	Quantity (pcs.)	Inductance		Q (min.)	DC Resistance (Ω) max.	Rated Current (mA)
			Nominal	Tolerance			
1	LQG15HS1N0S02	10	1.0nH	±0.3nH	8	0.07	300
2	LQG15HS1N1S02	10	1.1nH	±0.3nH	8	0.09	300
3	LQG15HS1N2S02	10	1.2nH	±0.3nH	8	0.09	300
4	LQG15HS1N3S02	10	1.3nH	±0.3nH	8	0.09	300
5	LQG15HS1N5S02	10	1.5nH	±0.3nH	8	0.10	300
6	LQG15HS1N6S02	10	1.6nH	±0.3nH	8	0.10	300
7	LQG15HS1N8S02	10	1.8nH	±0.3nH	8	0.10	300
8	LQG15HS2N0S02	10	2.0nH	±0.3nH	8	0.10	300
9	LQG15HS2N2S02	10	2.2nH	±0.3nH	8	0.12	300
10	LQG15HS2N4S02	10	2.4nH	±0.3nH	8	0.15	300
11	LQG15HS2N7S02	10	2.7nH	±0.3nH	8	0.15	300
12	LQG15HS3N0S02	10	3.0nH	±0.3nH	8	0.17	300
13	LQG15HS3N3S02	10	3.3nH	±0.3nH	8	0.17	300
14	LQG15HS3N6S02	10	3.6nH	±0.3nH	8	0.18	300
15	LQG15HS3N9S02	10	3.9nH	±0.3nH	8	0.18	300
16	LQG15HS4N3S02	10	4.3nH	±0.3nH	8	0.18	300
17	LQG15HS4N7S02	10	4.7nH	±0.3nH	8	0.18	300
18	LQG15HS5N1S02	10	5.1nH	±0.3nH	8	0.20	300
19	LQG15HS5N6S02	10	5.6nH	±0.3nH	8	0.20	300
20	LQG15HS6N2S02	10	6.2nH	±0.3nH	8	0.22	300
21	LQG15HS6N8J02	10	6.8nH	±5%	8	0.24	300
22	LQG15HS7N5J02	10	7.5nH	±5%	8	0.24	300
23	LQG15HS8N2J02	10	8.2nH	±5%	8	0.24	300
24	LQG15HS9N1J02	10	9.1nH	±5%	8	0.26	300
25	LQG15HS10NJ02	10	10nH	±5%	8	0.26	300
26	LQG15HS12NJ02	10	12nH	±5%	8	0.28	300
27	LQG15HS15NJ02	10	15nH	±5%	8	0.32	300
28	LQG15HS18NJ02	10	18nH	±5%	8	0.36	300
29	LQG15HS22NJ02	10	22nH	±5%	8	0.42	300
30	LQG15HS27NJ02	10	27nH	±5%	8	0.46	300
31	LQG15HS33NJ02	10	33nH	±5%	8	0.58	200
32	LQG15HS39NJ02	10	39nH	±5%	8	0.65	200
33	LQG15HS47NJ02	10	47nH	±5%	8	0.72	200
34	LQG15HS56NJ02	10	56nH	±5%	8	0.82	200
35	LQG15HS68NJ02	10	68nH	±5%	8	0.92	180
36	LQG15HS82NJ02	10	82nH	±5%	8	1.20	150
37	LQG15HSR10J02	10	100nH	±5%	8	1.25	150
38	LQG15HSR12J02	10	120nH	±5%	8	1.30	150
39	LQG15HSR15J02	10	150nH	±5%	8	2.99	140
40	LQG15HSR18J02	10	180nH	±5%	8	3.38	130

Continued on the following page.

Design Kits

Continued from the preceding page.

No.	Part Number	Quantity (pcs.)	Inductance		Q (min.)	DC Resistance (Ω) max.	Rated Current (mA)
			Nominal	Tolerance			
41	LQG15HSR22J02	10	220nH	±5%	8	3.77	120
42	LQG15HSR27J02	10	270nH	±5%	8	4.94	110

●EKLMOG18B (High Frequency Monolithic Type)

No.	Part Number	Quantity (pcs.)	Inductance		Q (min.)	DC Resistance (Ω) max.	Rated Current (mA)
			Nominal	Tolerance			
1	LQG18HN1N2S00	10	1.2nH	±0.3nH	12	0.10	300
2	LQG18HN1N5S00	10	1.5nH	±0.3nH	12	0.10	300
3	LQG18HN1N8S00	10	1.8nH	±0.3nH	12	0.10	300
4	LQG18HN2N2S00	10	2.2nH	±0.3nH	12	0.10	300
5	LQG18HN2N7S00	10	2.7nH	±0.3nH	12	0.15	300
6	LQG18HN3N3S00	10	3.3nH	±0.3nH	12	0.15	300
7	LQG18HN3N9S00	10	3.9nH	±0.3nH	12	0.15	300
8	LQG18HN4N7S00	10	4.7nH	±0.3nH	12	0.20	300
9	LQG18HN5N6S00	10	5.6nH	±0.3nH	12	0.20	300
10	LQG18HN6N8J00	10	6.8nH	±5%	12	0.25	300
11	LQG18HN8N2J00	10	8.2nH	±5%	12	0.25	300
12	LQG18HN10NJ00	10	10nH	±5%	12	0.30	300
13	LQG18HN12NJ00	10	12nH	±5%	12	0.35	300
14	LQG18HN15NJ00	10	15nH	±5%	12	0.40	300
15	LQG18HN18NJ00	10	18nH	±5%	12	0.45	300
16	LQG18HN22NJ00	10	22nH	±5%	12	0.50	300
17	LQG18HN27NJ00	10	27nH	±5%	12	0.55	300
18	LQG18HN33NJ00	10	33nH	±5%	12	0.60	300
19	LQG18HN39NJ00	10	39nH	±5%	12	0.65	300
20	LQG18HN47NJ00	10	47nH	±5%	12	0.70	300
21	LQG18HN56NJ00	10	56nH	±5%	12	0.75	300
22	LQG18HN68NJ00	10	68nH	±5%	12	0.80	300
23	LQG18HN82NJ00	10	82nH	±5%	12	0.85	300
24	LQG18HNR10J00	10	100nH	±5%	12	0.90	300

●EKLMP02B (High Frequency Film Type)

No.	Part Number	Quantity (pcs.)	Inductance		Q (min.)	DC Resistance (Ω) max.	Rated Current (mA)
			Nominal	Tolerance			
1	LQP02TN0N4S02	10	0.4nH	±0.3nH	8	0.60	160
2	LQP02TN0N5S02	10	0.5nH	±0.3nH	8	0.60	160
3	LQP02TN0N6S02	10	0.6nH	±0.3nH	8	0.60	160
4	LQP02TN0N7S02	10	0.7nH	±0.3nH	8	0.60	160
5	LQP02TN0N8S02	10	0.8nH	±0.3nH	8	0.60	160
6	LQP02TN0N9S02	10	0.9nH	±0.3nH	8	0.60	160
7	LQP02TN1N0S02	10	1.0nH	±0.3nH	8	0.90	110
8	LQP02TN1N1S02	10	1.1nH	±0.3nH	8	0.90	110
9	LQP02TN1N2S02	10	1.2nH	±0.3nH	8	0.90	110
10	LQP02TN1N3S02	10	1.3nH	±0.3nH	8	0.90	110
11	LQP02TN1N5S02	10	1.5nH	±0.3nH	8	0.90	110
12	LQP02TN1N6S02	10	1.6nH	±0.3nH	8	0.90	110
13	LQP02TN1N8S02	10	1.8nH	±0.3nH	8	1.35	100
14	LQP02TN2N0S02	10	2.0nH	±0.3nH	8	1.35	100
15	LQP02TN2N2S02	10	2.2nH	±0.3nH	8	1.35	100
16	LQP02TN2N4S02	10	2.4nH	±0.3nH	8	1.35	100

Continued on the following page. ↗

Design Kits

Continued from the preceding page.

No.	Part Number	Quantity (pcs.)	Inductance		Q (min.)	DC Resistance (Ω) max.	Rated Current (mA)
			Nominal	Tolerance			
17	LQP02TN2N7S02	10	2.7nH	±0.3nH	8	1.35	100
18	LQP02TN3N0S02	10	3.0nH	±0.3nH	8	1.35	100
19	LQP02TN3N3S02	10	3.3nH	±0.3nH	8	1.65	90
20	LQP02TN3N6S02	10	3.6nH	±0.3nH	8	1.65	90
21	LQP02TN3N9S02	10	3.9nH	±0.3nH	8	1.65	90
22	LQP02TN4N3S02	10	4.3nH	±0.3nH	8	1.65	90
23	LQP02TN4N7S02	10	4.7nH	±0.3nH	8	2.10	80
24	LQP02TN5N1S02	10	5.1nH	±0.3nH	8	2.10	80
25	LQP02TN5N6S02	10	5.6nH	±0.3nH	8	2.40	70
26	LQP02TN6N2J02	10	6.2nH	±5%	8	2.40	70
27	LQP02TN6N8J02	10	6.8nH	±5%	8	2.85	70
28	LQP02TN7N5J02	10	7.5nH	±5%	8	2.85	70
29	LQP02TN8N2J02	10	8.2nH	±5%	8	3.15	70
30	LQP02TN9N1J02	10	9.1nH	±5%	8	3.15	70
31	LQP02TN10N1J02	10	10nH	±5%	8	3.60	70

●EKLMP03J (High Frequency Film Type)

No.	Part Number	Quantity (pcs.)	Inductance		Q (min.)	DC Resistance (Ω) max.	Rated Current (mA)
			Nominal	Tolerance			
1	LQP03TN0N6B00	10	0.6nH	±0.1nH	13	0.08	420
2	LQP03TN1N0B00	10	1.0nH	±0.1nH	13	0.10	400
3	LQP03TN1N1B00	10	1.1nH	±0.1nH	13	0.13	280
4	LQP03TN1N2B00	10	1.2nH	±0.1nH	13	0.13	280
5	LQP03TN1N3B00	10	1.3nH	±0.1nH	13	0.16	280
6	LQP03TN1N4B00	10	1.4nH	±0.1nH	13	0.16	280
7	LQP03TN1N5B00	10	1.5nH	±0.1nH	13	0.16	280
8	LQP03TN1N6B00	10	1.6nH	±0.1nH	13	0.16	280
9	LQP03TN1N7B00	10	1.7nH	±0.1nH	13	0.16	280
10	LQP03TN1N8B00	10	1.8nH	±0.1nH	13	0.16	280
11	LQP03TN1N9B00	10	1.9nH	±0.1nH	13	0.18	220
12	LQP03TN2N0B00	10	2.0nH	±0.1nH	13	0.18	220
13	LQP03TN2N1B00	10	2.1nH	±0.1nH	13	0.18	220
14	LQP03TN2N2B00	10	2.2nH	±0.1nH	13	0.18	220
15	LQP03TN2N3B00	10	2.3nH	±0.1nH	13	0.21	220
16	LQP03TN2N4B00	10	2.4nH	±0.1nH	13	0.21	220
17	LQP03TN2N5B00	10	2.5nH	±0.1nH	13	0.21	220
18	LQP03TN2N6B00	10	2.6nH	±0.1nH	13	0.21	220
19	LQP03TN2N7B00	10	2.7nH	±0.1nH	13	0.21	220
20	LQP03TN2N8B00	10	2.8nH	±0.1nH	13	0.21	220
21	LQP03TN2N9B00	10	2.9nH	±0.1nH	13	0.21	220
22	LQP03TN3N0B00	10	3.0nH	±0.1nH	13	0.30	190
23	LQP03TN3N1B00	10	3.1nH	±0.1nH	13	0.30	190
24	LQP03TN3N2B00	10	3.2nH	±0.1nH	13	0.30	190
25	LQP03TN3N3B00	10	3.3nH	±0.1nH	13	0.30	190
26	LQP03TN3N4B00	10	3.4nH	±0.1nH	13	0.30	190
27	LQP03TN3N5B00	10	3.5nH	±0.1nH	13	0.30	190
28	LQP03TN3N6B00	10	3.6nH	±0.1nH	13	0.45	170
29	LQP03TN3N7B00	10	3.7nH	±0.1nH	13	0.45	170
30	LQP03TN3N8B00	10	3.8nH	±0.1nH	13	0.45	170
31	LQP03TN3N9B00	10	3.9nH	±0.1nH	13	0.45	170
32	LQP03TN4N3H00	10	4.3nH	±3%	13	0.55	160
33	LQP03TN4N7H00	10	4.7nH	±3%	13	0.55	160

Continued on the following page. ↗

Design Kits

Continued from the preceding page.

No.	Part Number	Quantity (pcs.)	Inductance		Q (min.)	DC Resistance (Ω) max.	Rated Current (mA)
			Nominal	Tolerance			
34	LQP03TN5N1H00	10	5.1nH	$\pm 3\%$	13	0.68	140
35	LQP03TN5N6H00	10	5.6nH	$\pm 3\%$	13	0.68	140
36	LQP03TN6N2H00	10	6.2nH	$\pm 3\%$	13	0.75	130
37	LQP03TN6N8H00	10	6.8nH	$\pm 3\%$	13	0.75	130
38	LQP03TN7N5H00	10	7.5nH	$\pm 3\%$	13	0.86	110
39	LQP03TN8N2H00	10	8.2nH	$\pm 3\%$	13	0.86	110
40	LQP03TN9N1H00	10	9.1nH	$\pm 3\%$	13	1.10	100
41	LQP03TN10NH00	10	10nH	$\pm 3\%$	13	1.10	100
42	LQP03TN12NH00	10	12nH	$\pm 3\%$	11	1.25	90
43	LQP03TN15NH00	10	15nH	$\pm 3\%$	11	1.40	90
44	LQP03TN18NH00	10	18nH	$\pm 3\%$	11	1.60	80
45	LQP03TN22NH00	10	22nH	$\pm 3\%$	11	2.55	70
46	LQP03TN27NH00	10	27nH	$\pm 3\%$	11	2.90	70
47	LQP03TN33NJ00	10	33nH	$\pm 5\%$	8	2.95	60
48	LQP03TN39NJ00	10	39nH	$\pm 5\%$	8	3.35	60
49	LQP03TN47NJ00	10	47nH	$\pm 5\%$	8	3.60	50
50	LQP03TN56NJ00	10	56nH	$\pm 5\%$	8	4.30	50
51	LQP03TN68NJ02	10	68nH	$\pm 5\%$	8	8.00	50
52	LQP03TN82NJ02	10	82nH	$\pm 5\%$	8	10.0	50
53	LQP03TNR10J02	10	100nH	$\pm 5\%$	8	10.0	40
54	LQP03TNR12J02	10	120nH	$\pm 5\%$	8	12.0	40

●EKLMQP15B (High Frequency Film Type)

No.	Part Number	Quantity (pcs.)	Inductance		Q (min.)	DC Resistance (Ω) max.	Rated Current (mA)
			Nominal	Tolerance			
1	LQP15MN1N0B02	10	1.0nH	0.1nH	13	0.1	400
2	LQP15MN1N1B02	10	1.1nH	0.1nH	13	0.1	390
3	LQP15MN1N2B02	10	1.2nH	0.1nH	13	0.1	390
4	LQP15MN1N3B02	10	1.3nH	0.1nH	13	0.2	280
5	LQP15MN1N5B02	10	1.5nH	0.1nH	13	0.2	280
6	LQP15MN1N6B02	10	1.6nH	0.1nH	13	0.3	220
7	LQP15MN1N8B02	10	1.8nH	0.1nH	13	0.2	280
8	LQP15MN2N0B02	10	2.0nH	0.1nH	13	0.3	220
9	LQP15MN2N2B02	10	2.2nH	0.1nH	13	0.3	220
10	LQP15MN2N4B02	10	2.4nH	0.1nH	13	0.3	220
11	LQP15MN2N7B02	10	2.7nH	0.1nH	13	0.3	220
12	LQP15MN3N0B02	10	3.0nH	0.1nH	13	0.4	190
13	LQP15MN3N3B02	10	3.3nH	0.1nH	13	0.4	190
14	LQP15MN3N6B02	10	3.6nH	0.1nH	13	0.5	170
15	LQP15MN3N9B02	10	3.9nH	0.1nH	13	0.5	170
16	LQP15MN4N3B02	10	4.3nH	0.1nH	13	0.6	160
17	LQP15MN4N7B02	10	4.7nH	0.1nH	13	0.6	160
18	LQP15MN5N1B02	10	5.1nH	± 0.1 nH	13	0.7	140
19	LQP15MN5N6B02	10	5.6nH	± 0.1 nH	13	0.7	140
20	LQP15MN6N2B02	10	6.2nH	± 0.1 nH	13	0.9	130
21	LQP15MN6N8B02	10	6.8nH	± 0.1 nH	13	0.9	130
22	LQP15MN7N5B02	10	7.5nH	± 0.1 nH	13	1.1	110
23	LQP15MN8N2B02	10	8.2nH	± 0.1 nH	13	1.1	110
24	LQP15MN9N1B02	10	9.1nH	± 0.1 nH	13	1.3	100
25	LQP15MN10NG02	10	10nH	$\pm 2\%$	13	1.3	100
26	LQP15MN12NG02	10	12nH	$\pm 2\%$	13	1.6	90
27	LQP15MN15NG02	10	15nH	$\pm 2\%$	13	1.8	90

Continued on the following page. 

Design Kits

Continued from the preceding page.

No.	Part Number	Quantity (pcs.)	Inductance		Q (min.)	DC Resistance (Ω) max.	Rated Current (mA)
			Nominal	Tolerance			
28	LQP15MN18NG02	10	18nH	±2%	13	2.0	80
29	LQP15MN22NG02	10	22nH	±2%	13	2.6	70
30	LQP15MN27NG02	10	27nH	±2%	13	3.1	70
31	LQP15MN33NG02	10	33nH	±2%	13	3.8	60

●EKLMQW04C (High Frequency Wire Wound Type)

No.	Part Number	Quantity (pcs.)	Inductance		Q (min.)	DC Resistance (Ω) max.	Rated Current (mA)
			Nominal	Tolerance			
1	LQW04AN1N1C00	10	1.1nH	±0.2nH	15	0.03	990
2	LQW04AN1N8C00	10	1.8nH	±0.2nH	15	0.06	700
3	LQW04AN2N7C00	10	2.7nH	±0.2nH	15	0.07	570
4	LQW04AN3N0C00	10	3.0nH	±0.2nH	15	0.07	620
5	LQW04AN3N6C00	10	3.6nH	±0.2nH	15	0.10	530
6	LQW04AN3N9C00	10	3.9nH	±0.2nH	15	0.10	530
7	LQW04AN4N3C00	10	4.3nH	±0.2nH	15	0.10	530
8	LQW04AN4N7C00	10	4.7nH	±0.2nH	20	0.14	440
9	LQW04AN5N1C00	10	5.1nH	±0.2nH	20	0.12	470
10	LQW04AN5N6C00	10	5.6nH	±0.2nH	20	0.12	470
11	LQW04AN6N2C00	10	6.2nH	±0.2nH	20	0.19	390
12	LQW04AN6N8C00	10	6.8nH	±0.2nH	20	0.14	440
13	LQW04AN7N5C00	10	7.5nH	±0.2nH	20	0.14	440
14	LQW04AN8N2C00	10	8.2nH	±0.2nH	20	0.23	350
15	LQW04AN9N1C00	10	9.1nH	±0.2nH	20	0.16	400
16	LQW04AN10NH00	10	10nH	±3%	20	0.26	330
17	LQW04AN11NH00	10	11nH	±3%	15	0.28	310
18	LQW04AN12NH00	10	12nH	±3%	15	0.28	310
19	LQW04AN13NH00	10	13nH	±3%	15	0.34	280
20	LQW04AN15NH00	10	15nH	±3%	15	0.48	240
21	LQW04AN16NH00	10	16nH	±3%	15	0.38	270
22	LQW04AN18NH00	10	18nH	±3%	15	0.54	220
23	LQW04AN19NH00	10	19nH	±3%	15	0.56	210
24	LQW04AN20NH00	10	20nH	±3%	15	0.56	210
25	LQW04AN22NH00	10	22nH	±3%	15	0.63	200
26	LQW04AN23NH00	10	23nH	±3%	15	0.95	160
27	LQW04AN24NH00	10	24nH	±3%	15	0.95	160
28	LQW04AN25NH00	10	25nH	±3%	15	0.95	160
29	LQW04AN27NH00	10	27nH	±3%	15	0.95	160
30	LQW04AN33NH00	10	33nH	±3%	15	1.11	140

●EKLMQW15H (High Frequency Wire Wound Type)

No.	Part Number	Quantity (pcs.)	Inductance		Q (min.)	DC Resistance (Ω) max.	Rated Current (mA)
			Nominal	Tolerance			
1	LQW15AN1N3C10	10	1.3nH	±0.2nH	20	0.017	1200
2	LQW15AN1N5B00	10	1.5nH	±0.1nH	10	0.03	1000
3	LQW15AN2N2C10	10	2.2nH	±0.2nH	25	0.027	1000
4	LQW15AN2N4B00	10	2.4nH	±0.1nH	20	0.05	850
5	LQW15AN2N5B00	10	2.5nH	±0.1nH	20	0.05	850
6	LQW15AN2N7B00	10	2.7nH	±0.1nH	20	0.05	850
7	LQW15AN2N9B00	10	2.9nH	±0.1nH	20	0.07	750
8	LQW15AN3N3D10	10	3.3nH	±0.5nH	30	0.040	900

Continued on the following page. ↗

Design Kits

Continued from the preceding page.

No.	Part Number	Quantity (pcs.)	Inductance		Q (min.)	DC Resistance (Ω) max.	Rated Current (mA)
			Nominal	Tolerance			
9	LQW15AN3N4C10	10	3.4nH	±0.2nH	30	0.040	900
10	LQW15AN3N6C10	10	3.6nH	±0.2nH	30	0.040	900
11	LQW15AN3N9B00	10	3.9nH	±0.1nH	25	0.07	750
12	LQW15AN4N1B00	10	4.1nH	±0.1nH	25	0.07	750
13	LQW15AN4N3B00	10	4.3nH	±0.1nH	25	0.07	750
14	LQW15AN4N7B00	10	4.7nH	±0.1nH	25	0.07	750
15	LQW15AN5N1B00	10	5.1nH	±0.1nH	25	0.12	600
16	LQW15AN5N6C10	10	5.6nH	±0.2nH	30	0.051	800
17	LQW15AN5N8B00	10	5.8nH	±0.1nH	25	0.12	700
18	LQW15AN6N2B00	10	6.2nH	±0.1nH	25	0.09	700
19	LQW15AN6N8G00	10	6.8nH	±2%	25	0.09	700
20	LQW15AN7N3G00	10	7.3nH	±2%	25	0.13	570
21	LQW15AN7N5G00	10	7.5nH	±2%	25	0.13	570
22	LQW15AN8N2G00	10	8.2nH	±2%	25	0.14	540
23	LQW15AN8N7G00	10	8.7nH	±2%	25	0.14	540
24	LQW15AN9N1G00	10	9.1nH	±2%	25	0.14	540
25	LQW15AN9N5G00	10	9.5nH	±2%	25	0.14	540
26	LQW15AN10NG00	10	10nH	±2%	25	0.17	500
27	LQW15AN11NG00	10	11nH	±2%	30	0.14	500
28	LQW15AN12NG00	10	12nH	±2%	30	0.14	500
29	LQW15AN13NG00	10	13nH	±2%	25	0.21	430
30	LQW15AN15NG00	10	15nH	±2%	30	0.16	460
31	LQW15AN16NG00	10	16nH	±2%	25	0.24	370
32	LQW15AN18NG00	10	18nH	±2%	25	0.27	370
33	LQW15AN19NG00	10	19nH	±2%	25	0.27	370
34	LQW15AN20NG00	10	20nH	±2%	25	0.27	370
35	LQW15AN22NG00	10	22nH	±2%	25	0.30	310
36	LQW15AN23NG00	10	23nH	±2%	25	0.30	310
37	LQW15AN24NG00	10	24nH	±2%	25	0.52	280
38	LQW15AN27NG00	10	27nH	±2%	25	0.52	280
39	LQW15AN30NG00	10	30nH	±2%	25	0.58	270
40	LQW15AN33NG00	10	33nH	±2%	25	0.63	260
41	LQW15AN36NG00	10	36nH	±2%	25	0.63	260
42	LQW15AN39NG00	10	39nH	±2%	25	0.70	250
43	LQW15AN40NG00	10	40nH	±2%	25	0.70	250
44	LQW15AN43NG00	10	43nH	±2%	25	0.70	250
45	LQW15AN47NG00	10	47nH	±2%	25	1.08	210
46	LQW15AN51NG00	10	51nH	±2%	25	1.08	210
47	LQW15AN56NG00	10	56nH	±2%	25	1.17	200
48	LQW15AN62NG00	10	62nH	±2%	20	1.82	145
49	LQW15AN68NG00	10	68nH	±2%	20	1.96	140
50	LQW15AN75NG00	10	75nH	±2%	20	2.10	135
51	LQW15AN82NG00	10	82nH	±2%	20	2.24	130
52	LQW15AN91NG00	10	91nH	±2%	20	2.38	125
53	LQW15ANR10J00	10	100nH	±5%	20	2.52	120
54	LQW15ANR12J00	10	120nH	±5%	20	2.66	110

●EKLMQ18GB (High Frequency Wire Wound Type)

No.	Part Number	Quantity (pcs.)	Inductance		Q (min.)	DC Resistance (Ω) max.	Rated Current (mA)
			Nominal	Tolerance			
1	LQW18AN3N6C00	10	3.6nH	±0.2nH	25	0.059	850
2	LQW18AN3N9C00	10	3.9nH	±0.2nH	35	0.059	850

Continued on the following page. ↗

Design Kits

Continued from the preceding page.

No.	Part Number	Quantity (pcs.)	Inductance		Q (min.)	DC Resistance (Ω) max.	Rated Current (mA)
			Nominal	Tolerance			
3	LQW18AN4N3C00	10	4.3nH	±0.2nH	35	0.059	850
4	LQW18AN5N6C00	10	5.6nH	±0.2nH	35	0.082	750
5	LQW18AN6N2C00	10	6.2nH	±0.2nH	35	0.082	750
6	LQW18AN6N8C00	10	6.8nH	±0.2nH	35	0.082	750
7	LQW18AN10NG00	10	10nH	±2%	35	0.11	650
8	LQW18AN11NG00	10	11nH	±2%	35	0.11	650
9	LQW18AN12NG00	10	12nH	±2%	35	0.13	600
10	LQW18AN13NG00	10	13nH	±2%	35	0.13	600
11	LQW18AN15NG00	10	15nH	±2%	40	0.13	600
12	LQW18AN16NG00	10	16nH	±2%	40	0.16	550
13	LQW18AN18NG00	10	18nH	±2%	40	0.16	550
14	LQW18AN20NG00	10	20nH	±2%	40	0.16	550
15	LQW18AN22NG00	10	22nH	±2%	40	0.17	500
16	LQW18AN24NG00	10	24nH	±2%	40	0.21	500
17	LQW18AN27NG00	10	27nH	±2%	40	0.21	440
18	LQW18AN30NG00	10	30nH	±2%	40	0.23	420
19	LQW18AN33NG00	10	33nH	±2%	40	0.23	420
20	LQW18AN36NG00	10	36nH	±2%	40	0.26	400
21	LQW18AN39NG00	10	39nH	±2%	40	0.26	400
22	LQW18AN43NG00	10	43nH	±2%	40	0.29	380
23	LQW18AN47NG00	10	47nH	±2%	38	0.29	380
24	LQW18AN51NG00	10	51nH	±2%	38	0.33	370
25	LQW18AN56NG00	10	56nH	±2%	38	0.35	360
26	LQW18AN62NG00	10	62nH	±2%	38	0.51	280
27	LQW18AN68NG00	10	68nH	±2%	38	0.38	340
28	LQW18AN72NG00	10	72nH	±2%	34	0.56	270
29	LQW18AN75NG00	10	75nH	±2%	34	0.56	270
30	LQW18AN82NG00	10	82nH	±2%	34	0.60	250
31	LQW18AN91NG00	10	91nH	±2%	34	0.64	230
32	LQW18ANR10G00	10	100nH	±2%	34	0.68	220
33	LQW18ANR11G00	10	110nH	±2%	32	1.2	200
34	LQW18ANR12G00	10	120nH	±2%	32	1.3	180
35	LQW18ANR13G00	10	130nH	±2%	32	1.4	170
36	LQW18ANR15G00	10	150nH	±2%	32	1.5	160
37	LQW18ANR16G00	10	160nH	±2%	32	2.1	150
38	LQW18ANR18G00	10	180nH	±2%	25	2.2	140
39	LQW18ANR20G00	10	200nH	±2%	25	2.4	120
40	LQW18ANR22G00	10	220nH	±2%	25	2.5	120
41	LQW18ANR27G00	10	270nH	±2%	30	3.4	110
42	LQW18ANR33G00	10	330nH	±2%	30	5.5	85
43	LQW18ANR39G00	10	390nH	±2%	30	6.2	80
44	LQW18ANR47G00	10	470nH	±2%	30	7.0	75
45	LQW18AN3N9C10	10	3.9nH	±0.2nH	38	0.032	1000
46	LQW18AN6N8C10	10	6.8nH	±0.2nH	38	0.045	900
47	LQW18AN10NG10	10	10nH	±2%	38	0.058	800
48	LQW18AN12NG10	10	12nH	±2%	38	0.071	750
49	LQW18AN18NG10	10	18nH	±2%	42	0.085	700
50	LQW18AN22NG10	10	22nH	±2%	42	0.099	640
51	LQW18AN27NG10	10	27nH	±2%	42	0.116	590

Continued on the following page. 

Design Kits

 Continued from the preceding page.

●EKLMQ18JB (High Frequency Wire Wound Type)

No.	Part Number	Quantity (pcs.)	Inductance		Q (min.)	DC Resistance (Ω) max.	Rated Current (mA)
			Nominal	Tolerance			
1	LQW18AN2N2D10	10	2.2nH	±0.5nH	25	0.018	1400
2	LQW18AN3N6D00	10	3.6nH	±0.5nH	25	0.059	850
3	LQW18AN3N9D10	10	3.9nH	±0.5nH	38	0.032	1000
4	LQW18AN4N3D00	10	4.3nH	±0.5nH	35	0.059	850
5	LQW18AN4N7D00	10	4.7nH	±0.5nH	35	0.059	850
6	LQW18AN5N6D10	10	5.6nH	±0.5nH	38	0.045	900
7	LQW18AN6N2D00	10	6.2nH	±0.5nH	35	0.082	750
8	LQW18AN6N8D10	10	6.8nH	±0.5nH	38	0.045	900
9	LQW18AN7N5D00	10	7.5nH	±0.5nH	35	0.082	750
10	LQW18AN8N2D10	10	8.2nH	±0.5nH	38	0.058	800
11	LQW18AN8N7D00	10	8.7nH	±0.5nH	35	0.11	650
12	LQW18AN9N1D00	10	9.1nH	±0.5nH	35	0.11	650
13	LQW18AN9N5D00	10	9.5nH	±0.5nH	35	0.11	650
14	LQW18AN10NJ10	10	10nH	±5%	38	0.058	800
15	LQW18AN11NJ00	10	11nH	±5%	35	0.11	650
16	LQW18AN12NJ10	10	12nH	±5%	38	0.071	750
17	LQW18AN13NJ00	10	13nH	±5%	35	0.13	600
18	LQW18AN15NJ10	10	15nH	±5%	42	0.085	700
19	LQW18AN16NJ00	10	16nH	±5%	40	0.16	550
20	LQW18AN18NJ10	10	18nH	±5%	42	0.085	700
21	LQW18AN20NJ00	10	20nH	±5%	40	0.16	550
22	LQW18AN22NJ10	10	22nH	±5%	42	0.099	640
23	LQW18AN24NJ00	10	24nH	±5%	40	0.21	500
24	LQW18AN27NJ10	10	27nH	±5%	42	0.116	590
25	LQW18AN30NJ00	10	30nH	±5%	40	0.23	420
26	LQW18AN33NJ10	10	33nH	±5%	42	0.132	550
27	LQW18AN36NJ00	10	36nH	±5%	40	0.26	400
28	LQW18AN39NJ00	10	39nH	±5%	40	0.26	400
29	LQW18AN43NJ00	10	43nH	±5%	40	0.29	380
30	LQW18AN47NJ00	10	47nH	±5%	38	0.29	380
31	LQW18AN51NJ00	10	51nH	±5%	38	0.33	370
32	LQW18AN56NJ00	10	56nH	±5%	38	0.35	360
33	LQW18AN62NJ00	10	62nH	±5%	38	0.51	280
34	LQW18AN68NJ00	10	68nH	±5%	38	0.38	340
35	LQW18AN72NJ00	10	72nH	±5%	34	0.56	270
36	LQW18AN75NJ00	10	75nH	±5%	34	0.56	270
37	LQW18AN82NJ00	10	82nH	±5%	34	0.60	250
38	LQW18AN91NJ00	10	91nH	±5%	34	0.64	230
39	LQW18ANR10J00	10	100nH	±5%	34	0.68	220
40	LQW18ANR11J00	10	110nH	±5%	32	1.2	200
41	LQW18ANR12J00	10	120nH	±5%	32	1.3	180
42	LQW18ANR13J00	10	130nH	±5%	32	1.4	170
43	LQW18ANR15J00	10	150nH	±5%	32	1.5	160
44	LQW18ANR16J00	10	160nH	±5%	32	2.1	150
45	LQW18ANR18J00	10	180nH	±5%	25	2.2	140
46	LQW18ANR20J00	10	200nH	±5%	25	2.4	120
47	LQW18ANR22J00	10	220nH	±5%	25	2.5	120
48	LQW18ANR27J00	10	270nH	±5%	30	3.4	110
49	LQW18ANR33J00	10	330nH	±5%	30	5.5	85
50	LQW18ANR39J00	10	390nH	±5%	30	6.2	80
51	LQW18ANR47J00	10	470nH	±5%	30	7.0	75

Continued on the following page. 

Design Kits

 Continued from the preceding page.

●EKLMQW21A (for High Frequency Wire Wound Ferrite Type)

No.	Part Number	Quantity (pcs.)	Inductance		Q (min.)	DC Resistance (Ω) max.	Rated Current (mA)
			Nominal	Tolerance			
1	LQW21HNR47J00	10	0.47μH	±5%	35	1.30	160
2	LQW21HNR56J00	10	0.56μH	±5%	35	1.43	150
3	LQW21HNR68J00	10	0.68μH	±5%	35	2.21	130
4	LQW21HNR82J00	10	0.82μH	±5%	35	2.34	125
5	LQW21HN1R0J00	10	1.0μH	±5%	35	2.86	115
6	LQW21HN1R2J00	10	1.2μH	±5%	35	3.12	100
7	LQW21HN1R5J00	10	1.5μH	±5%	35	5.33	85
8	LQW21HN1R8J00	10	1.8μH	±5%	35	5.85	80
9	LQW21HN2R2J00	10	2.2μH	±5%	35	6.50	75

●EKLMQW2BB (for High Frequency Wire Wound Air-core Type)

No.	Part Number	Quantity (pcs.)	Inductance		Q (min.)	DC Resistance (Ω) max.	Rated Current (mA)
			Nominal	Tolerance			
1	LQW2BHN2N7D13	10	2.7nH	±0.5nH	20	0.02	1900
2	LQW2BHN3N1D13	10	3.1nH	±0.5nH	20	0.02	1800
3	LQW2BHN3N3D13	10	3.3nH	±0.5nH	20	0.02	1700
4	LQW2BHN5N6D13	10	5.6nH	±0.5nH	35	0.02	1500
5	LQW2BHN6N8D13	10	6.8nH	±0.5nH	35	0.02	1400
6	LQW2BHN8N6D13	10	8.6nH	±0.5nH	35	0.03	1300
7	LQW2BHN10NJ13	10	10nH	±5%	35	0.03	1320
8	LQW2BHN12NK13	10	12nH	±10%	40	0.04	1100
9	LQW2BHN15NK13	10	15nH	±10%	40	0.04	1000
10	LQW2BHN18NK13	10	18.8nH	±10%	40	0.05	1000
11	LQW2BHN21NK13	10	21nH	±10%	40	0.05	950
12	LQW2BHN27NK13	10	27nH	±10%	40	0.06	900
13	LQW2BHN33NJ03	10	33nH	±5%	40	0.15	570
14	LQW2BHN39NJ03	10	39nH	±5%	40	0.09	730
15	LQW2BHN47NJ03	10	47nH	±5%	40	0.23	450
16	LQW2BHN56NJ03	10	56nH	±5%	40	0.26	430
17	LQW2BHN68NJ03	10	68nH	±5%	40	0.23	460
18	LQW2BHN82NJ03	10	82nH	±5%	40	0.42	320
19	LQW2BHNR10J03	10	100nH	±5%	40	0.38	350
20	LQW2BHNR12J03	10	120nH	±5%	40	0.40	320
21	LQW2BHNR15J03	10	150nH	±5%	30	0.47	390
22	LQW2BHNR18J03	10	180nH	±5%	35	0.71	250
23	LQW2BHNR22J03	10	220nH	±5%	35	0.70	240
24	LQW2BHNR27K03	10	270nH	±10%	15	2.00	190
25	LQW2BHNR33K03	10	330nH	±10%	15	2.20	180
26	LQW2BHNR39K03	10	390nH	±10%	15	2.50	170
27	LQW2BHNR47K03	10	470nH	±10%	15	2.80	160

●EKLMQM18B (for General Use Monolithic Type)

No.	Part Number	Quantity (pcs.)	Inductance		Q (min.)	DC Resistance (Ω) max.	Rated Current (mA)
			Nominal	Tolerance			
1	LQM18NN47NM00	10	47nH	±20%	10	0.30	50
2	LQM18NN68NM00	10	68nH	±20%	10	0.30	50
3	LQM18NN82NM00	10	82nH	±20%	10	0.30	50
4	LQM18NNR10K00	10	100nH	±10%	15	0.50	50

Continued on the following page. 

Design Kits

Continued from the preceding page.

No.	Part Number	Quantity (pcs.)	Inductance		Q (min.)	DC Resistance (Ω) max.	Rated Current (mA)
			Nominal	Tolerance			
5	LQM18NNR12K00	10	120nH	±10%	15	0.50	50
6	LQM18NNR15K00	10	150nH	±10%	15	0.60	50
7	LQM18NNR18K00	10	180nH	±10%	15	0.60	50
8	LQM18NNR22K00	10	220nH	±10%	15	0.80	50
9	LQM18NNR27K00	10	270nH	±10%	15	0.80	50
10	LQM18NNR33K00	10	330nH	±10%	15	0.85	35
11	LQM18NNR39K00	10	390nH	±10%	15	1.00	35
12	LQM18NNR47K00	10	470nH	±10%	15	1.35	35
13	LQM18NNR56K00	10	560nH	±10%	15	1.55	35
14	LQM18NNR68K00	10	680nH	±10%	15	1.70	35
15	LQM18NNR82K00	10	820nH	±10%	15	2.10	35
16	LQM18NN1R0K00	10	1000nH	±10%	35	0.60	25
17	LQM18NN1R2K00	10	1200nH	±10%	35	0.80	25
18	LQM18NN1R5K00	10	1500nH	±10%	35	0.80	25
19	LQM18NN1R8K00	10	1800nH	±10%	35	0.95	25
20	LQM18NN2R2K00	10	2200nH	±10%	35	1.15	15

●EKLMM21NB (for General Use Monolithic Type)

No.	Part Number	Quantity (pcs.)	Inductance		Q (min.)	DC Resistance (Ω) max.	Rated Current (mA)
			Nominal	Tolerance			
1	LQM21NNR10K10	10	0.1μH	±10%	20	0.26	250
2	LQM21NNR12K10	10	0.12μH	±10%	20	0.29	250
3	LQM21NNR15K10	10	0.15μH	±10%	20	0.32	250
4	LQM21NNR18K10	10	0.18μH	±10%	20	0.35	250
5	LQM21NNR22K10	10	0.22μH	±10%	20	0.38	250
6	LQM21NNR27K10	10	0.27μH	±10%	20	0.42	250
7	LQM21NNR33K10	10	0.33μH	±10%	20	0.48	250
8	LQM21NNR39K10	10	0.39μH	±10%	25	0.53	200
9	LQM21NNR47K10	10	0.47μH	±10%	25	0.57	200
10	LQM21NNR56K10	10	0.56μH	±10%	25	0.63	150
11	LQM21NNR68K10	10	0.68μH	±10%	25	0.72	150
12	LQM21NNR82K10	10	0.82μH	±10%	25	0.81	150
13	LQM21NN1R0K10	10	1.0μH	±10%	45	0.40	50
14	LQM21NN1R2K10	10	1.2μH	±10%	45	0.47	50
15	LQM21NN1R5K10	10	1.5μH	±10%	45	0.50	50
16	LQM21NN1R8K10	10	1.8μH	±10%	45	0.57	50
17	LQM21NN2R2K10	10	2.2μH	±10%	45	0.63	30
18	LQM21NN2R7K10	10	2.7μH	±10%	45	0.69	30
19	LQM21NN3R3K10	10	3.3μH	±10%	45	0.80	30
20	LQM21NN3R9K10	10	3.9μH	±10%	45	0.89	30
21	LQM21NN4R7K10	10	4.7μH	±10%	45	1.00	30

●EKLMMH32MC (for General Use Wire Wound Type)

No.	Part Number	Quantity (pcs.)	Inductance		DC Resistance (Ω) max.	Rated Current (mA)
			Nominal	Tolerance		
1	LQH32MN1R0M23	10	1.0μH	±20%	0.50	445
2	LQH32MN1R2M23	10	1.2μH	±20%	0.60	425
3	LQH32MN1R5K23	10	1.5μH	±10%	0.60	400
4	LQH32MN1R8K23	10	1.8μH	±10%	0.70	390
5	LQH32MN2R2K23	10	2.2μH	±10%	0.80	370

Continued on the following page. ↗

Design Kits

Continued from the preceding page.

No.	Part Number	Quantity (pcs.)	Inductance		DC Resistance (Ω) max.	Rated Current (mA)
			Nominal	Tolerance		
6	LQH32MN2R7K23	10	2.7μH	±10%	0.90	320
7	LQH32MN3R3K23	10	3.3μH	±10%	1.00	300
8	LQH32MN3R9K23	10	3.9μH	±10%	1.10	290
9	LQH32MN4R7K23	10	4.7μH	±10%	1.20	270
10	LQH32MN5R6K23	10	5.6μH	±10%	1.30	250
11	LQH32MN6R8K23	10	6.8μH	±10%	1.50	240
12	LQH32MN8R2K23	10	8.2μH	±10%	1.60	225
13	LQH32MN100K23	10	10μH	±10%	1.8	190
14	LQH32MN120K23	10	12μH	±10%	2.0	180
15	LQH32MN150K23	10	15μH	±10%	2.2	170
16	LQH32MN180K23	10	18μH	±10%	2.5	165
17	LQH32MN220K23	10	22μH	±10%	2.8	150
18	LQH32MN270K23	10	27μH	±10%	3.1	125
19	LQH32MN330K23	10	33μH	±10%	3.5	115
20	LQH32MN390K23	10	39μH	±10%	3.9	110
21	LQH32MN470K23	10	47μH	±10%	4.3	100
22	LQH32MN560K23	10	56μH	±10%	4.9	85
23	LQH32MN680K23	10	68μH	±10%	5.5	80
24	LQH32MN820K23	10	82μH	±10%	6.2	70
25	LQH32MN101K23	10	100μH	±10%	7.0	80
26	LQH32MN121K23	10	120μH	±10%	8.0	75
27	LQH32MN151K23	10	150μH	±10%	9.3	70
28	LQH32MN181K23	10	180μH	±10%	10.2	65
29	LQH32MN221K23	10	220μH	±10%	11.8	65
30	LQH32MN271K23	10	270μH	±10%	12.5	65
31	LQH32MN331K23	10	330μH	±10%	13.0	65
32	LQH32MN391K23	10	390μH	±10%	22.0	50
33	LQH32MN471K23	10	470μH	±10%	25.0	45
34	LQH32MN561K23	10	560μH	±10%	28.0	40

●EKL43MB (for General Use Wire Wound Type)

No.	Part Number	Quantity (pcs.)	Inductance		DC Resistance (Ω) max.	Rated Current (mA)
			Nominal	Tolerance		
1	LQH43MN1R0M03	10	1.0μH	±20%	0.20	500
2	LQH43MN1R2M03	10	1.2μH	±20%	0.20	500
3	LQH43MN1R5M03	10	1.5μH	±20%	0.30	500
4	LQH43MN1R8M03	10	1.8μH	±20%	0.30	500
5	LQH43MN2R2M03	10	2.2μH	±20%	0.30	500
6	LQH43MN2R7M03	10	2.7μH	±20%	0.32	500
7	LQH43MN3R3M03	10	3.3μH	±20%	0.35	500
8	LQH43MN3R9M03	10	3.9μH	±20%	0.38	500
9	LQH43MN4R7K03	10	4.7μH	±10%	0.40	500
10	LQH43MN5R6K03	10	5.6μH	±10%	0.47	500
11	LQH43MN6R8K03	10	6.8μH	±10%	0.50	450
12	LQH43MN8R2K03	10	8.2μH	±10%	0.56	450
13	LQH43MN100K03	10	10μH	±10%	0.56	400
14	LQH43MN120K03	10	12μH	±10%	0.62	380
15	LQH43MN150K03	10	15μH	±10%	0.73	360
16	LQH43MN180K03	10	18μH	±10%	0.82	340
17	LQH43MN220K03	10	22μH	±10%	0.94	320
18	LQH43MN270K03	10	27μH	±10%	1.10	300
19	LQH43MN330K03	10	33μH	±10%	1.20	270

Continued on the following page. ↗

Design Kits

Continued from the preceding page.

No.	Part Number	Quantity (pcs.)	Inductance		DC Resistance (Ω) max.	Rated Current (mA)
			Nominal	Tolerance		
20	LQH43MN390K03	10	39μH	±10%	1.40	240
21	LQH43MN470K03	10	47μH	±10%	1.50	220
22	LQH43MN560K03	10	56μH	±10%	1.7	200
23	LQH43MN680K03	10	68μH	±10%	1.9	180
24	LQH43MN820K03	10	82μH	±10%	2.2	170
25	LQH43MN101K03	10	100μH	±10%	2.5	160
26	LQH43MN121K03	10	120μH	±10%	3.0	150
27	LQH43MN151K03	10	150μH	±10%	3.7	130
28	LQH43MN181K03	10	180μH	±10%	4.5	120
29	LQH43MN221K03	10	220μH	±10%	5.4	110
30	LQH43MN271K03	10	270μH	±10%	6.8	100
31	LQH43MN331K03	10	330μH	±10%	8.2	95
32	LQH43MN391K03	10	390μH	±10%	9.7	90
33	LQH43MN471K03	10	470μH	±10%	11.8	80
34	LQH43MN561K03	10	560μH	±10%	14.5	70
35	LQH43MN681K03	10	680μH	±10%	17.0	65
36	LQH43MN821K03	10	820μH	±10%	20.5	60
37	LQH43MN102K03	10	1000μH	±10%	25.0	50
38	LQH43MN122K03	10	1200μH	±10%	30.0	45
39	LQH43MN152K03	10	1500μH	±10%	37.0	40
40	LQH43NN182K03	10	1800μH	±10%	45.0	35
41	LQH43NN222K03	10	2200μH	±10%	50.0	30

●EKLMQ2PC (for DC-DC Converter Monolithic Type)

No.	Part Number	Quantity (pcs.)	Inductance		DC Resistance (Ω) max.	Rated Current (mA)
			Nominal	Tolerance		
1	LQM21PNR47MC0	10	0.47μH	±20%	0.12±25%	1100
2	LQM21PN1R0MC0	10	1.0μH	±20%	0.19±25%	800
3	LQM21PN1R5MC0	10	1.5μH	±20%	0.26±25%	700
4	LQM21PN2R2MC0	10	2.2μH	±20%	0.34±25%	600
5	LQM2MPNR47NG0	10	0.47μH	±30%	0.06±25%	1600
6	LQM2MPN1R0NG0	10	1.0μH	±30%	0.085±25%	1400
7	LQM2MPN1R5NG0	10	1.5μH	±30%	0.11±25%	1200
8	LQM2MPN2R2NG0	10	2.2μH	±30%	0.11±25%	1200
9	LQM2MPN3R3NG0	10	3.3μH	±30%	0.12±25%	1200
10	LQM2MPN4R7NG0	10	4.7μH	±30%	0.14±25%	1100
11	LQM2HPNR56ME0	10	0.56μH	±20%	0.06±25%	1500
12	LQM2HPNR47MG0	10	0.47μH	±20%	0.04±25%	1800
13	LQM2HPN1R0MG0	10	1.0μH	±20%	0.055±25%	1600
14	LQM2HPN1R5MG0	10	1.5μH	±20%	0.07±25%	1500
15	LQM2HPN2R2MG0	10	2.2μH	±20%	0.08±25%	1300
16	LQM2HPN3R3MG0	10	3.3μH	±20%	0.10±25%	1200
17	LQM2HPN4R7MG0	10	4.7μH	±20%	0.11±25%	1100
18	LQM2HPN1R0MJ0	10	1.0μH	±20%	0.09±25%	1500
19	LQM2HPN2R2MJ0	10	2.2μH	±20%	0.12±25%	1000
20	LQM2HPN3R3MJ0	10	3.3μH	±20%	0.12±25%	1000
21	LQM31PNR47MC0	10	0.47μH	±20%	0.085±25%	1300
22	LQM31PN1R0MC0	10	1.0μH	±20%	0.14±25%	1100
23	LQM31PN1R5MC0	10	1.5μH	±20%	0.17±25%	1000
24	LQM31PN2R2MC0	10	2.2μH	±20%	0.25±25%	900
25	LQM31PNR47M00	10	0.47μH	±20%	0.07±25%	1400
26	LQM31PN1R0M00	10	1.0μH	±20%	0.12±25%	1200

Continued on the following page. ↗

Design Kits

Continued from the preceding page.

No.	Part Number	Quantity (pcs.)	Inductance		DC Resistance (Ω) max.	Rated Current (mA)
			Nominal	Tolerance		
27	LQM31PN1R5M00	10	1.5μH	±20%	0.14±25%	1000
28	LQM31PN2R2M00	10	2.2μH	±20%	0.19±25%	900
29	LQM31PN3R3M00	10	3.3μH	±20%	0.24±25%	800
30	LQM31PN4R7M00	10	4.7μH	±20%	0.30±25%	700

●EKLHM2MCE (for DC-DC Converter Wire Wound Type)

No.	Part Number	Quantity (pcs.)	Inductance		DC Resistance (Ω) max.	Allowable DC Current (mA)	
			Nominal	Tolerance		Based on Temperature Rise	Based on Inductance Change
1	LQH2MCN1R0M02	10	1.0μH	±20%	0.30±30%	485	-
2	LQH2MCN1R5M02	10	1.5μH	±20%	0.40±30%	445	-
3	LQH2MCN2R2M02	10	2.2μH	±20%	0.48±30%	425	-
4	LQH2MCN3R3M02	10	3.3μH	±20%	0.60±30%	375	-
5	LQH2MCN4R7M02	10	4.7μH	±20%	0.8±30%	300	-
6	LQH2MCN5R6M02	10	5.6μH	±20%	0.9±30%	280	-
7	LQH2MCN6R8M02	10	6.8μH	±20%	1.0±30%	255	-
8	LQH2MCN8R2M02	10	8.2μH	±20%	1.1±30%	235	-
9	LQH2MCN100K02	10	10μH	±10%	1.2±30%	225	-
10	LQH2MCN120K02	10	12μH	±10%	1.4±30%	210	-
11	LQH2MCN150K02	10	15μH	±10%	1.6±30%	200	-
12	LQH2MCN180K02	10	18μH	±10%	1.8±30%	190	-
13	LQH2MCN220K02	10	22μH	±10%	2.1±30%	185	-
14	LQH2MCN270K02	10	27μH	±10%	2.5±30%	180	-
15	LQH2MCN330K02	10	33μH	±10%	2.8±30%	160	-
16	LQH2MCN390K02	10	39μH	±10%	4.4±30%	125	-
17	LQH2MCN470K02	10	47μH	±10%	5.1±30%	120	-
18	LQH2MCN560K02	10	56μH	±10%	5.7±30%	110	-
19	LQH2MCN680K02	10	68μH	±10%	6.6±30%	100	-
20	LQH2MCN820K02	10	82μH	±10%	7.5±30%	90	-
21	LQH2MCN1R0M52	10	1.0μH	±20%	0.25±30%	595	-
22	LQH2MCN1R5M52	10	1.5μH	±20%	0.33±30%	540	-
23	LQH2MCN2R2M52	10	2.2μH	±20%	0.42±30%	500	-
24	LQH2MCN3R3M52	10	3.3μH	±20%	0.74±30%	360	-
25	LQH2MCN4R7M52	10	4.7μH	±20%	0.91±30%	335	-
26	LQH2MCN6R8M52	10	6.8μH	±20%	1.23±30%	285	-
27	LQH2MCN100M52	10	10μH	±20%	2.27±30%	200	-

●EKLMQH3PA (for DC-DC Converter Wire Wound Type)

No.	Part Number	Quantity (pcs.)	Inductance		DC Resistance (Ω) max.	Allowable DC Current (mA)	
			Nominal	Tolerance		Based on Temperature Rise	Based on Inductance Change
1	LQH3NPN1R0NG0	10	1.0μH	±30%	0.08±20%	1525	1650
2	LQH3NPN1R5NG0	10	1.5μH	±30%	0.10±20%	1470	1300
3	LQH3NPN2R2NG0	10	2.2μH	±30%	0.14±20%	1270	1250
4	LQH3NPN3R3NG0	10	3.3μH	±30%	0.18±20%	1130	850
5	LQH3NPN4R7NG0	10	4.7μH	±30%	0.26±20%	925	800
6	LQH3NPN6R8NG0	10	6.8μH	±30%	0.45±20%	710	650
7	LQH3NPN100NG0	10	10μH	±30%	0.57±20%	630	500
8	LQH3NPN150NG0	10	15μH	±30%	0.91±20%	475	370
9	LQH3NPN220MG0	10	22μH	±20%	1.1±20%	430	340
10	LQH3NPN330MG0	10	33μH	±20%	2.1±20%	345	250
11	LQH3NPN470MG0	10	47μH	±20%	3.0±20%	270	170

Continued on the following page. ↗

Design Kits

Continued from the preceding page.

No.	Part Number	Quantity (pcs.)	Inductance		DC Resistance (Ω) max.	Allowable DC Current (mA)	
			Nominal	Tolerance		Based on Temperature Rise	Based on Inductance Change
12	LQH3NPN680MG0	10	68 μ H	$\pm 20\%$	4.2 $\pm 20\%$	235	150
13	LQH3NPN101MG0	10	100 μ H	$\pm 20\%$	8.0 $\pm 20\%$	165	140
14	LQH3NPN151MG0	10	150 μ H	$\pm 20\%$	11 $\pm 20\%$	145	110
15	LQH3NPN221MG0	10	220 μ H	$\pm 20\%$	14 $\pm 20\%$	130	100
16	LQH3NPN251MG0	10	250 μ H	$\pm 20\%$	15 $\pm 20\%$	130	80
17	LQH3NPN1R0NM0	10	1.0 μ H	$\pm 30\%$	0.044 $\pm 20\%$	2050	1400
18	LQH3NPN2R2NM0	10	2.2 μ H	$\pm 30\%$	0.073 $\pm 20\%$	1600	1250
19	LQH3NPN3R3NM0	10	3.3 μ H	$\pm 30\%$	0.092 $\pm 20\%$	1450	1000
20	LQH3NPN4R7NM0	10	4.7 μ H	$\pm 30\%$	0.13 $\pm 20\%$	1250	880
21	LQH3NPN6R8NM0	10	6.8 μ H	$\pm 30\%$	0.20 $\pm 20\%$	1000	820
22	LQH3NPN100NM0	10	10 μ H	$\pm 30\%$	0.26 $\pm 20\%$	870	550
23	LQH3NPN220MM0	10	22 μ H	$\pm 20\%$	0.51 $\pm 20\%$	650	410
24	LQH3NPN330MM0	10	33 μ H	$\pm 20\%$	0.85 $\pm 20\%$	500	370
25	LQH3NPN470MM0	10	47 μ H	$\pm 20\%$	1.25 $\pm 20\%$	410	310
26	LQH3NPN101MM0	10	100 μ H	$\pm 20\%$	3.50 $\pm 20\%$	240	200
27	LQH32PNR47NN0	10	0.47 μ H	$\pm 30\%$	0.03 $\pm 20\%$	2550	3400
28	LQH32PN1R0NN0	10	1.0 μ H	$\pm 30\%$	0.045 $\pm 20\%$	2050	2300
29	LQH32PN1R5NN0	10	1.5 μ H	$\pm 30\%$	0.057 $\pm 20\%$	1750	1750
30	LQH32PN2R2NN0	10	2.2 μ H	$\pm 30\%$	0.076 $\pm 20\%$	1600	1550
31	LQH32PN3R3NN0	10	3.3 μ H	$\pm 30\%$	0.12 $\pm 20\%$	1200	1250
32	LQH32PN4R7NN0	10	4.7 μ H	$\pm 30\%$	0.18 $\pm 20\%$	1000	1000
33	LQH32PN6R8NN0	10	6.8 μ H	$\pm 30\%$	0.24 $\pm 20\%$	850	850
34	LQH32PN100MN0	10	10 μ H	$\pm 20\%$	0.38 $\pm 20\%$	700	750
35	LQH32PN220MN0	10	22 μ H	$\pm 20\%$	0.81 $\pm 20\%$	450	500

●EKLMM18FB (for Choke Monolithic Type)

No.	Part Number	Quantity (pcs.)	Inductance		DC Resistance (Ω)	Rated Current (mA)
			Nominal	Tolerance		
1	LQM18FN1R0M00	10	1.0 μ H	$\pm 20\%$	0.20 $\pm 30\%$	150
2	LQM18FN2R2M00	10	2.2 μ H	$\pm 20\%$	0.40 $\pm 30\%$	120
3	LQM18FN4R7M00	10	4.7 μ H	$\pm 20\%$	0.60 $\pm 30\%$	80
4	LQM18FN100M00	10	10 μ H	$\pm 20\%$	0.90 $\pm 30\%$	50
5	LQM21FN1R0N00	10	1.0 μ H	$\pm 30\%$	0.20 $\pm 30\%$	220
6	LQM21FN2R2N00	10	2.2 μ H	$\pm 30\%$	0.28 $\pm 30\%$	150
7	LQM21FN4R7M70	10	4.7 μ H	$\pm 20\%$	0.35 $\pm 30\%$	120
8	LQM21FN4R7M80	10	4.7 μ H	$\pm 20\%$	0.18 $\pm 30\%$	120
9	LQM21FN100M70	10	10 μ H	$\pm 20\%$	0.60 $\pm 30\%$	100
10	LQM21FN100M80	10	10 μ H	$\pm 20\%$	0.30 $\pm 30\%$	100
11	LQM21FN220N00	10	22 μ H	$\pm 30\%$	0.35 $\pm 30\%$	13
12	LQM21FN470N00	10	47 μ H	$\pm 30\%$	0.60 $\pm 30\%$	7
13	LQM31FN100M00	10	10 μ H	$\pm 20\%$	0.50 max.	70

●EKLMMH32CC (for Choke Wire Wound Type)

No.	Part Number	Quantity (pcs.)	Inductance		DC Resistance (Ω)	Rated Current (mA)
			Nominal	Tolerance		
1	LQH32CNR15M33	10	0.15 μ H	$\pm 20\%$	0.028 $\pm 30\%$	1450
2	LQH32CNR27M33	10	0.27 μ H	$\pm 20\%$	0.034 $\pm 30\%$	1250
3	LQH32CNR47M33	10	0.47 μ H	$\pm 20\%$	0.042 $\pm 30\%$	1100
4	LQH32CN1R0M33	10	1.0 μ H	$\pm 20\%$	0.06 $\pm 30\%$	1000
5	LQH32CN2R2M33	10	2.2 μ H	$\pm 20\%$	0.097 $\pm 30\%$	790

Continued on the following page. 

Design Kits

Continued from the preceding page.

No.	Part Number	Quantity (pcs.)	Inductance		DC Resistance (Ω)	Rated Current (mA)
			Nominal	Tolerance		
6	LQH32CN4R7M33	10	4.7μH	±20%	0.15±30%	650
7	LQH32CN100K33	10	10μH	±10%	0.3±30%	450
8	LQH32CN1R0M23	10	1.0μH	±20%	0.09±30%	800
9	LQH32CN2R2M23	10	2.2μH	±20%	0.13±30%	600
10	LQH32CN4R7M23	10	4.7μH	±20%	0.2±30%	450
11	LQH32CN100K23	10	10μH	±10%	0.44±30%	300
12	LQH32CN220K23	10	22μH	±10%	0.71±30%	250
13	LQH32CN470K23	10	47μH	±10%	1.3±30%	170
14	LQH32CN101K23	10	100μH	±10%	3.5±30%	100
15	LQH32CN221K23	10	220μH	±10%	8.4±30%	70
16	LQH32CN331K23	10	330μH	±10%	10±30%	60
17	LQH32CN391K23	10	390μH	±10%	17±30%	60
18	LQH32CN471K23	10	470μH	±10%	19±30%	60
19	LQH32CN561K23	10	560μH	±10%	22±30%	60
20	LQH32CN1R0M53	10	1.0μH	±20%	0.06±30%	1000
21	LQH32CN2R2M53	10	2.2μH	±20%	0.097±30%	790
22	LQH32CN4R7M53	10	4.7μH	±20%	0.15±30%	650
23	LQH32CN100K53	10	10μH	±10%	0.3±30%	450
24	LQH32CN150K53	10	15μH	±10%	0.58±30%	300
25	LQH32CN220K53	10	22μH	±10%	0.71±30%	250
26	LQH32CN330K53	10	33μH	±10%	1.1±30%	200
27	LQH32CN470K53	10	47μH	±10%	1.3±30%	170
28	LQH32CN680K53	10	68μH	±10%	2.2±30%	130
29	LQH32CN101K53	10	100μH	±10%	3.5±30%	100

●EKL43CC (for Choke Wire Wound Type)

No.	Part Number	Quantity (pcs.)	Inductance		DC Resistance (Ω)	Rated Current (mA)
			Nominal	Tolerance		
1	LQH43CN1R0M03	10	1.0μH	±20%	0.08 max	1080
2	LQH43CN1R5M03	10	1.5μH	±20%	0.09 max	1000
3	LQH43CN2R2M03	10	2.2μH	±20%	0.11 max	900
4	LQH43CN3R3M03	10	3.3μH	±20%	0.13 max	800
5	LQH43CN4R7M03	10	4.7μH	±20%	0.15 max	750
6	LQH43CN6R8M03	10	6.8μH	±20%	0.20 max	720
7	LQH43CN100K03	10	10μH	±10%	0.24 max	650
8	LQH43CN150K03	10	15μH	±10%	0.32 max	570
9	LQH43CN220K03	10	22μH	±10%	0.60 max	420
10	LQH43CN330K03	10	33μH	±10%	1.00 max	310
11	LQH43CN470K03	10	47μH	±10%	1.10 max	280
12	LQH43CN680K03	10	68μH	±10%	1.70 max	220
13	LQH43CN101K03	10	100μH	±10%	2.20 max	190
14	LQH43CN151K03	10	150μH	±10%	3.50 max	130
15	LQH43CN221K03	10	220μH	±10%	4.00 max	110
16	LQH43CN331K03	10	330μH	±10%	6.80 max	100
17	LQH43CN471K03	10	470μH	±10%	8.50 max	90

Information

1. Land Area and Q-F Characteristics

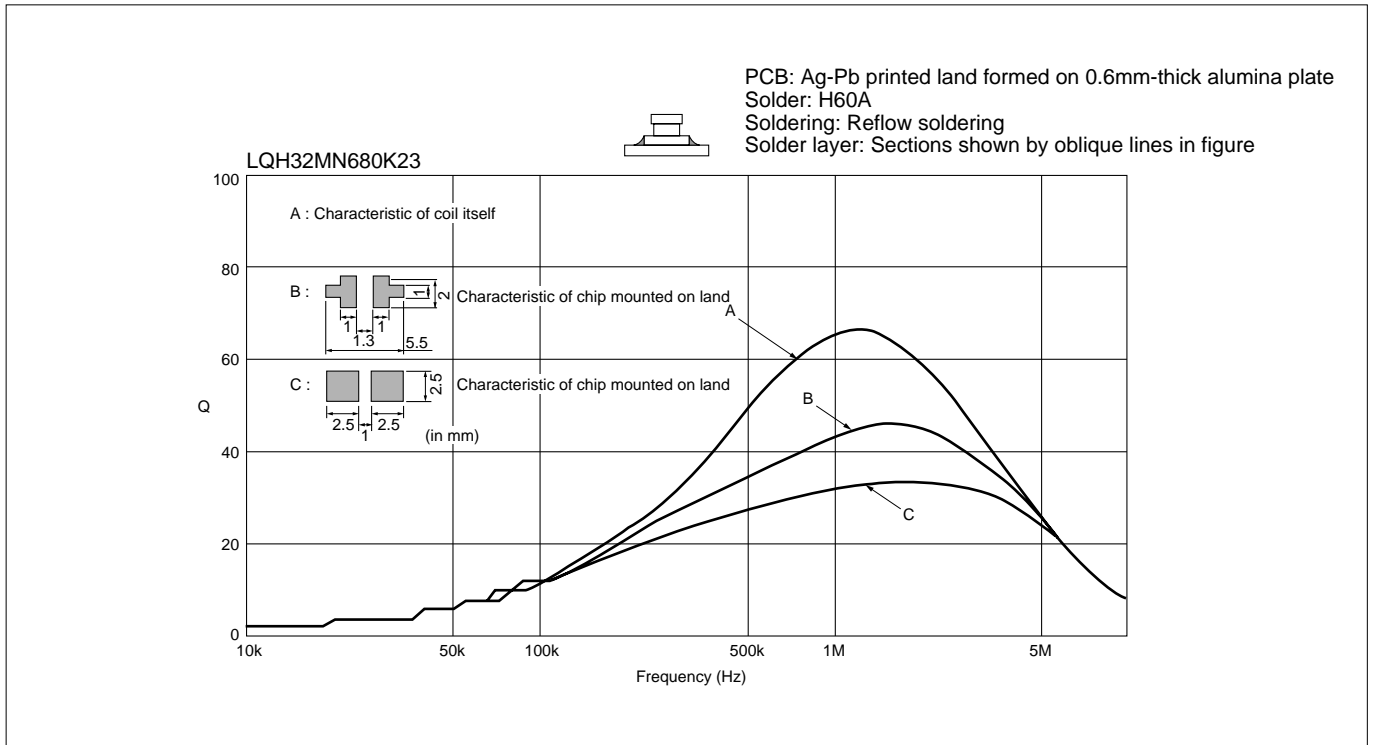

2. Coupling coefficient versus Coil-to-coil Spacing

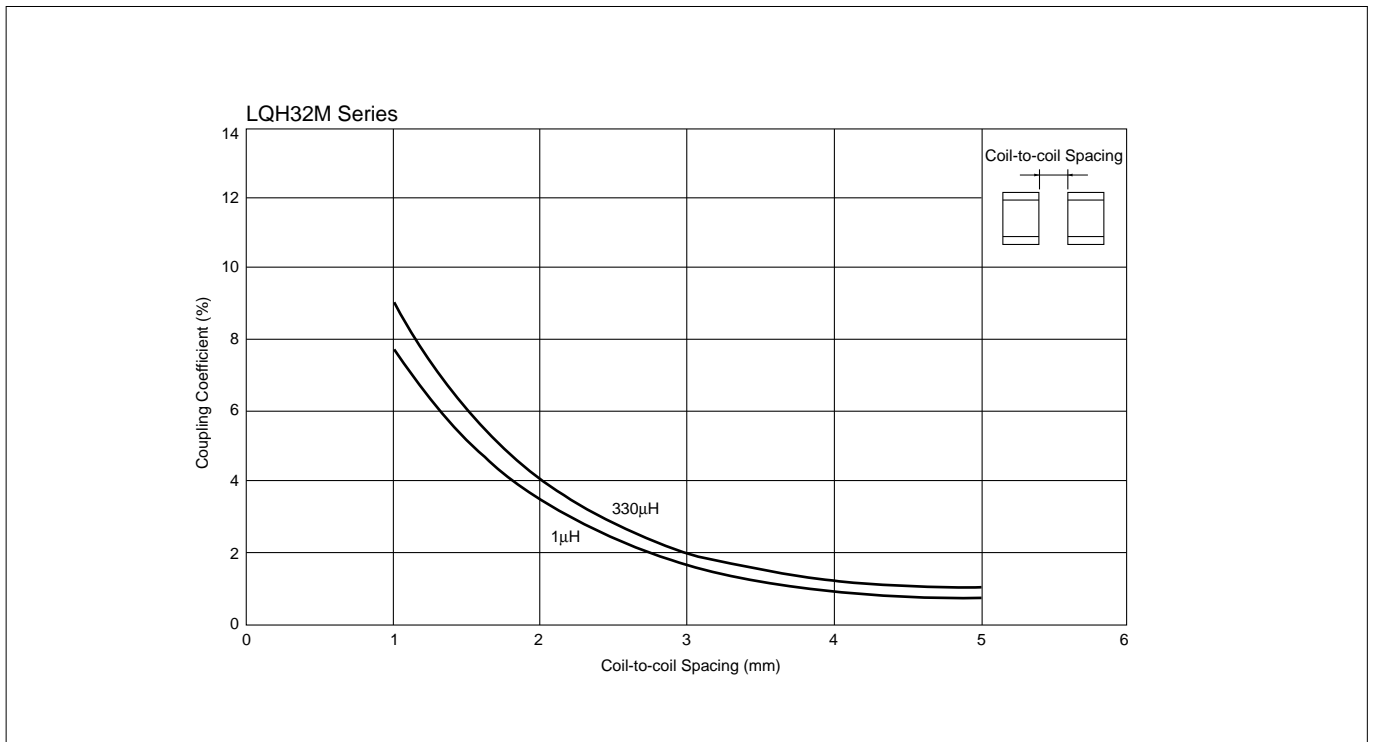



Murata Chip S-Parameter & Impedance Library

Download Service

The program enables you to calculate, view and print graphs of impedance and S parameter of chip capacitors or chip inductors.

S parameter data in Touchstone format can also be copied.

Main Window

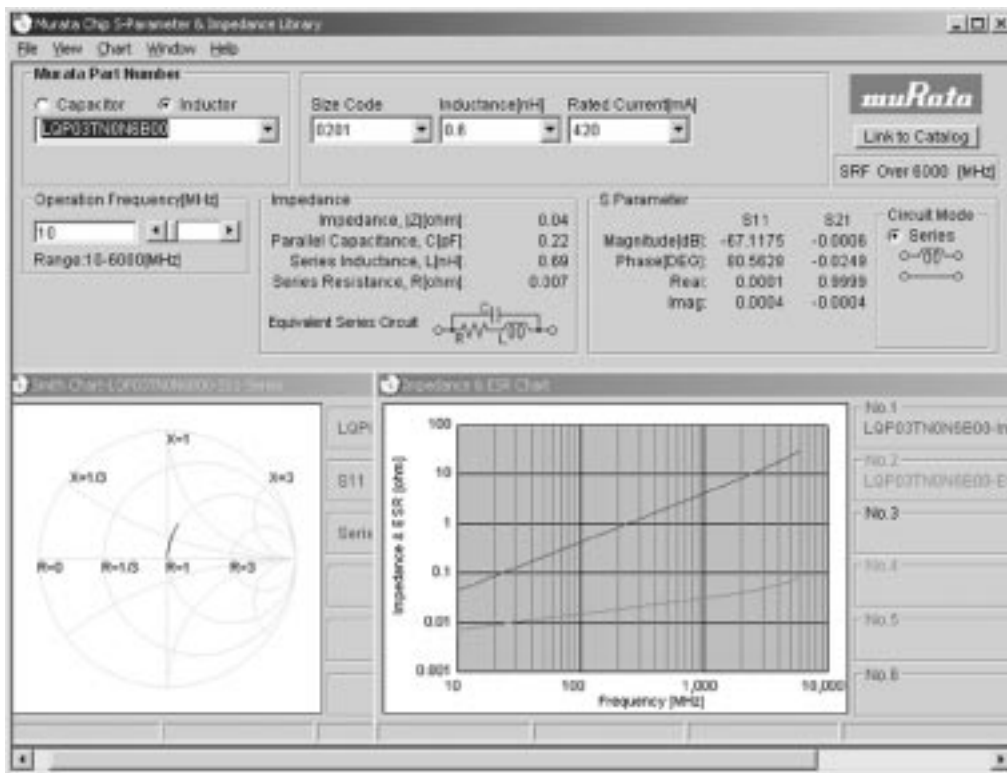

- Easy operation due to using Windows interface.
- Fast calculation of data and graph for S parameter and impedance of chip capacitors or chip inductors.
- S parameter is saved in your personal computer and utilized for circuit simulation.

This simulator can be downloaded from Murata's website.

<http://www.murata.com/designlib/mcsil.html>

△ Note:

1. Export Control

<For customers outside Japan>

No muRata products should be used or sold, through any channels, for use in the design, development, production, utilization, maintenance or operation of, or otherwise contribution to (1) any weapons (Weapons of Mass Destruction [nuclear, chemical or biological weapons or missiles] or conventional weapons) or (2) goods or systems specially designed or intended for military end-use or utilization by military end-users.

<For customers in Japan>

For products which are controlled items subject to the "Foreign Exchange and Foreign Trade Law" of Japan, the export license specified by the law is required for export.

2. Please contact our sales representatives or product engineers before using the products in this catalog for the applications listed below, which require especially high reliability for the prevention of defects which might directly damage a third party's life, body or property, or when one of our products is intended for use in applications other than those specified in this catalog.

- | | |
|-----------------------------|--|
| ① Aircraft equipment | ② Aerospace equipment |
| ③ Undersea equipment | ④ Power plant equipment |
| ⑤ Medical equipment | ⑥ Transportation equipment (vehicles, trains, ships, etc.) |
| ⑦ Traffic signal equipment | ⑧ Disaster prevention / crime prevention equipment |
| ⑨ Data-processing equipment | ⑩ Application of similar complexity and/or reliability requirements to the applications listed above |

3. Product specifications in this catalog are as of July 2008. They are subject to change or our products in it may be discontinued without advance notice. Please check with our sales representatives or product engineers before ordering. If there are any questions, please contact our sales representatives or product engineers.

4. Please read rating and △ CAUTION (for storage, operating, rating, soldering, mounting and handling) in this catalog to prevent smoking and/or burning, etc.

5. This catalog has only typical specifications because there is no space for detailed specifications. Therefore, please approve our product specifications or transact the approval sheet for product specifications before ordering.

6. Please note that unless otherwise specified, we shall assume no responsibility whatsoever for any conflict or dispute that may occur in connection with the effect of our and/or a third party's intellectual property rights and other related rights in consideration of your use of our products and/or information described or contained in our catalogs. In this connection, no representation shall be made to the effect that any third parties are authorized to use the rights mentioned above under licenses without our consent.

7. No ozone depleting substances (ODS) under the Montreal Protocol are used in our manufacturing process.