

## Cylindrical type proximity sensor

2-wire non-polarity

Line-up

### ■ Features

- Improved the noise resistance with dedicated IC
- Built-in reverse polarity protection circuit (DC 3-wire type)
- Built-in surge protection circuit
- Built-in overcurrent protection circuit(DC type)
- Long life cycle and high reliability, and simple operation
- Protection structure IP67(IEC standard)
- Replaceable for micro switches and limit switches

**⚠ Please read "Caution for your safety" in operation manual before using.**



### ■ Specifications

#### ● DC 2-wire type

※When the □ model name is X, it is non-polarity model.

Model	PRT08-1.5DO PRT08-1.5DC	PRT08-2DO PRT08-2DC	PRT12-2□DO PRT12-2□DC	PRT12-4□DO PRT12-4□DC	PRT18-5□DO PRT18-5□DC	PRT18-8□DO PRT18-8□DC	PRT30-10□DO PRT30-10□DC PRT30-10□DO-V	PRT30-15□DO PRT30-15□DC
Sensing distance	1.5mm	2mm	2mm	4mm	5mm	8mm	10mm	15mm
Hysteresis	Max. 10% of sensing distance							
Standard sensing target	8×8×1mm (Iron)		12×12×1mm (Iron)		18×18×1mm (Iron)	25×25×1mm (Iron)	30×30×1mm (Iron)	45×45×1mm (Iron)
Sensing distance	0 to 1.05mm	0 to 1.4mm	0 to 1.4mm	0 to 2.8mm	0 to 3.5mm	0 to 5.6mm	0 to 7mm	0 to 10.5mm
Power supply (Operating voltage)	12-24VDC (10-30VDC)							
Current consumption	Max. 0.6mA							
Response frequency※1	1.5kHz	1kHz	1.5kHz	500Hz	350Hz	400Hz	200Hz	
Residual voltage※2	Max. 3.5V(Non-polarity type is Max. 5V)							
Affection by Temp.	Max. ±10% for sensing distance at ambient temperature 20°C(For PRT08 Series : ±20% Max.)							
Control output	2 to 100mA							
Insulation resistance	Min. 50MΩ(at 500VDC megger)							
Dielectric strength	1500VAC 50/60Hz for 1minute							
Vibration	1mm amplitude at frequency of 10 to 55Hz(for 1 min.) in each of X, Y, Z directions for 2 hours							
Shock	500m/s <sup>2</sup> (approx. 50G) in X, Y, Z direction for 3 times							
Indicator	Operation indicator(red LED)							
Environment	Ambient temperature	-25 to 70°C, storage: -30 to 80°C						
	Ambient humidity	35 to 95% RH, storage: 35 to 95% RH						
Protection circuit	Surge protection circuit		Surge protection circuit, Overcurrent protection circuit					
Protection	IP67(IEC standard)							
Cable	ø3.5, 3-wire, 2m (AWG24, Core diameter: 0.08mm, Number of cores: 40, Insulator diameter: ø1)		ø4, 2-wire, 2m		ø5, 2-wire, 2m			
	(AWG22, Core diameter: 0.08mm, Number of cores: 60, Insulator diameter: ø1.25)							
Material	Case/Nut: Nickel plated Brass, Washer: Nickel plated Iron, Sensing surface: PBT, Standard cable(Black): Polyvinyl chloride(PVC), Oil resistant cable(Gray): Oil resistant Polyvinyl chloride(PVC)							
Approval	CE							
Weight※3	Approx. 64g(approx. 52g)		Approx.84g(approx. 72g)		Approx.122g(approx. 110g)		Approx.207g(approx. 170g)	

※1: The response frequency is the average value. The standard sensing target is used and the width is set as 2 times of the standard sensing target, 1/2 of the sensing distance for the distance.

※2: Before using non-polarity type, check the condition of connected device because residual voltage is 5V.

※3: The weight with packaging and the weight in parentheses is only unit weight.

※Environment resistance is rated at no freezing or condensation.

(A) Photo electric sensor

(B) Fiber optic sensor

(C) Door/Area sensor

(D) Proximity sensor

(E) Pressure sensor

(F) Rotary encoder

(G) Connector/Socket

(H) Temp. controller

(I) SSR/ Power controller

(J) Counter

(K) Timer

(L) Panel meter

(M) Tacho/ Speed/ Pulse meter

(N) Display unit

(O) Sensor controller

(P) Switching mode power supply

(Q) Stepper motor& Driver&Controller

(R) Graphic/ Logic panel

(S) Field network device

(T) Software

(U) Other

# PR Series

## ■ Specifications

### ● DC 2-wire type

Model	PR08-1.5DN PR08-1.5DP PR08-1.5DN2 PR08-1.5DP2 PRL08-1.5DN PRL08-1.5DP PRL08-1.5DN2 PRL08-1.5DP2	PR08-2DN PR08-2DP PR08-2DN2 PR08-2DP2 PRL08-2DN PRL08-2DP PRL08-2DN2 PRL08-2DP2	PR12-2DN PR12-2DP PR12-2DN2 PR12-2DP2 PRS12-2DN PRS12-2DP PRS12-2DN2 PRS12-2DP2	PR12-4DN PR12-4DP PR12-4DN2 PR12-4DP2 PRS12-4DN PRS12-4DP PRS12-4DN2 PRS12-4DP2 PRL12-4DN PRL12-4DP	PR18-5DN PR18-5DP PR18-5DN2 PR18-5DP2 PR18-5DN-V PRL18-5DN PRL18-5DP PRL18-5DN2 PRL18-5DP2	PR18-8DN PR18-8DP PR18-8DN2 PR18-8DP2 PRL18-8DN PRL18-8DP PRL18-8DN2 PRL18-8DP2	PR30-10DN PR30-10DP PR30-10DN2 PR30-10DP2 PRL30-10DN PRL30-10DP PRL30-10DN2 PRL30-10DP2	PR30-15DN PR30-15DP PR30-15DN2 PR30-15DP2 PRL30-15DN PRL30-15DP PRL30-15DN2 PRL30-15DP2
Sensing distance	1.5mm	2mm	2mm	4mm	5mm	8mm	10mm	15mm
Hysteresis	Max. 10% of sensing distance							
Standard sensing target	8×8×1mm(Iron)		12×12×1mm(Iron)		18×18×1mm (Iron)	25×25×1mm (Iron)	30×30×1mm (Iron)	45×45×1mm (Iron)
Setting distance	0 to 1.05mm	0 to 1.4mm	0 to 1.4mm	0 to 2.8mm	0 to 3.5mm	0 to 5.6mm	0 to 7mm	0 to 10.5mm
Power supply (Operation voltage)	12-24VDC (10-30VDC)							
Leakage current	Max. 10mA							
Response frequency※1	1.5kHz	1kHz	1.5kHz	500Hz		350Hz	400Hz	200kHz
Residual voltage	Max. 2.0V		Max. 1.5V					
Affection by Temp.	Max. ±10% for sensing distance at ambient temperature 20°C, PR08 Series : Max. ±20%							
Control output	Max. 200mA							
Insulation resistance	Min. 50MΩ(at 500VDC megger)							
Dielectric strength	1500VAC 50/60Hz for 1minute							
Vibration	1mm amplitude at frequency of 10 to 55Hz(for 1 min.) in each of X, Y, Z directions for 2 hours							
Shock	500m/s <sup>2</sup> (approx. 50G) in X, Y, Z direction for 3 times							
Indicator	Operation indicator(red LED)							
Environment	Ambient temperature	-25 to 70°C, storage: -30 to 80°C						
	Ambient humidity	30 to 95%RH, storage: 35 to 95%RH						
Protection circuit	Surge protection circuit, Reverse polarity protection circuit, Overcurrent protection circuit							
Protection	IP67(IEC standard)							
Material	Case/Nut: Nickel plated Brass, Washer: Nickel plated Iron, Sensing surface: PBT, Standard cable(Black): Polyvinyl chloride(PVC), Oil resistant cable(Gray): Oil resistant Polyvinyl chloride(PVC)							
Cable	ø3.5, 3-wire, 2m (AWG24, Core diameter: 0.08mm, Number of cores: 40, Insulator diameter: ø1)		ø4, 3-wire, 2m		ø5, 3-wire, 2m			
	AWG22, Core diameter: 0.08mm, Number of cores: 60, Insulator diameter: ø1.25)							
Approval	CE							
Weight※2	PR: Approx. 64g(approx. 52g) PRL: Approx. 66g(approx. 54g)		PR: Approx. 84g(approx. 72g) PRS: Approx. 82g(approx. 70g) PRL: Approx. 88g(approx. 76g)		PR: Approx. 122g(approx. 110g) PRL: Approx. 142g(approx. 130g)		PR: Approx. 207g(approx. 170g) PRL: Approx. 247g(approx. 210g)	

※1: The response frequency is the average value. The standard sensing target is used and the width is set as 2 times of the standard sensing target, 1/2 of the sensing distance for the distance.

※2: The weight with packaging and the weight in parentheses is only unit weight.

※Environment resistance is rated at no freezing or condensation.

# Cylindrical type Proximity Sensor

## ■ Specifications

### ● AC 2-wire type

Model	PR12-2AO PR12-2AC	PR12-4AO PR12-4AC	PR18-5AO PR18-5AC PRL18-5AO PRL18-5AC	PR18-8AO PR18-8AC PRL18-8AO PRL18-8AC	PR30-10AO PR30-10AC PRL30-10AO PRL30-10AC	PR30-15AO PR30-15AC PRL30-15AO PRL30-15AC
Sensing distance	2mm	4mm	5mm	8mm	10mm	15mm
Hysteresis	Max. 10% of sensing distance					
Standard sensing target	12×12×1mm(Iron)		18×18×1mm(Iron)	25×25×1mm(Iron)	30×30×1mm(Iron)	45×45×1mm(Iron)
Setting distance	0 to 1.4mm	0 to 2.8mm	0 to 3.5mm	0 to 5.6mm	0 to 7mm	0 to 10.5mm
Power supply (Operation voltage)	100-240VAC (85-264VAC)					
Leakage current	Max. 2.5mA					
Response frequency※1	20Hz					
Residual voltage	Max. 10V					
Affection by Temp.	Max. ±10% for sensing distance at ambient temperature 20°C					
Control output	5 to 150mA		5 to 200mA			
Insulation resistance	Min. 50MΩ(at 500VDC megger)					
Dielectric strength	2,500VAC 50/60Hz for 1minute					
Vibration	1mm amplitude at frequency of 10 to 55Hz(for 1 min.) in each of X, Y, Z directions for 2 hours					
Shock	500m/s <sup>2</sup> (approx. 50G) in X, Y, Z direction for 3 times					
Indicator	Operation indicator(red LED)					
Environment	Ambient temperature	-25 to 70°C, storage: -30 to 80°C				
	Ambient humidity	30 to 95%RH, storage: 35 to 95%RH				
Protection circuit	Surge protection circuit					
Protection	IP67(IEC standard)					
Material	ø4, 2-wire, 2m		ø5, 2-wire, 2m			
	(AWG22, Core diameter: 0.08mm, Number of cores: 60, Insulator diameter: ø1.25)					
Insulation type	Double insulation or reinforced insulation (Mark: □, dielectric strength between the measuring input part and the power part: 1kV)					
Material	Case/Nut: Nickel plated Brass, Washer: Nickel plated Iron, Sensing surface: PBT, Standard cable(Black): Polyvinyl chloride(PVC)					
Approval	CE					
Weight※2	Approx. 84g(approx. 66g)		PR: Approx. 130g(approx. 118g) PRL: Approx. 142g(approx. 130g)		PR: Approx. 207g(approx. 170g) PRL: Approx. 245g(approx. 208g)	

※1: The response frequency is the average value. The standard sensing target is used and the width is set as 2 times of the standard sensing target, 1/2 of the sensing distance for the distance.

※2: The weight with packaging and the weight in parentheses is only unit weight.

※Environment resistance is rated at no freezing or condensation.

(A) Photo electric sensor

(B) Fiber optic sensor

(C) Door/Area sensor

(D) Proximity sensor

(E) Pressure sensor

(F) Rotary encoder

(G) Connector/Socket

(H) Temp. controller

(I) SSR/Power controller

(J) Counter

(K) Timer

(L) Panel meter

(M) Tacho/Speed/Pulse meter

(N) Display unit

(O) Sensor controller

(P) Switching mode power supply

(Q) Stepper motor& Driver&Controller

(R) Graphic/Logic panel

(S) Field network device

(T) Software

(U) Other

# PR Series

## ■ Dimensions

(unit: mm)

### ● PR(T)08-1.5D □

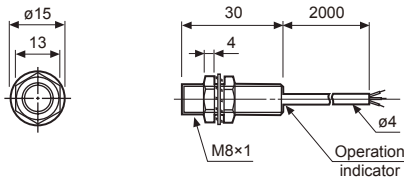

### ● PR(T)08-2D □

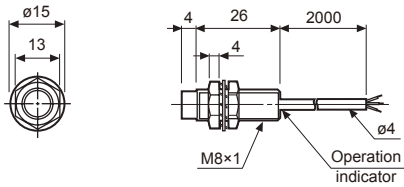

### ● PR(T)18-5D □

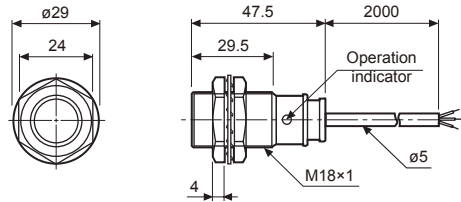

### ● PR(T)18-8D □

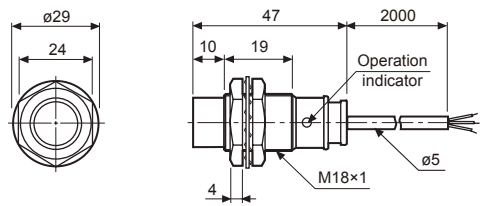

### ● PRS12-2D □

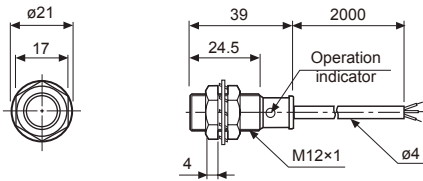

### ● PRS12-4D □

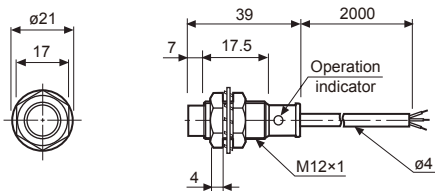

### ● PR(T)30-10D □

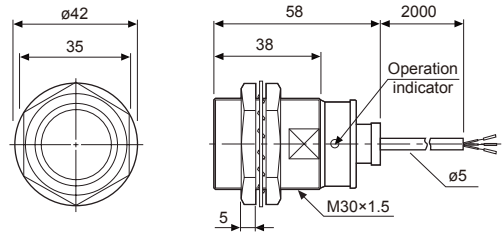

### ● PR(T)30-15D □

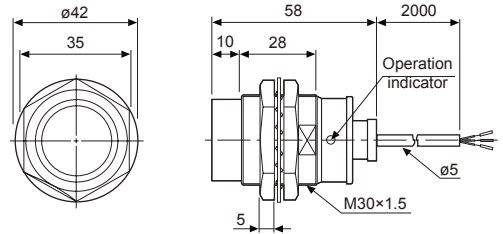

### ● PR(T)12-2D □

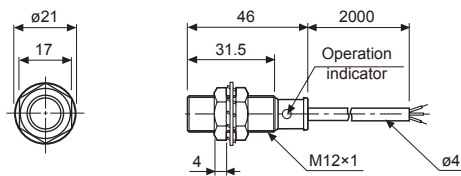

### ● PR(T)12-4D □

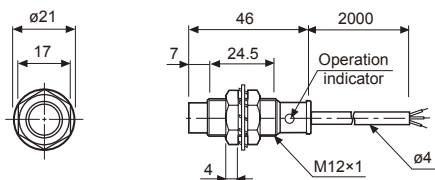

### ● PRL08-1.5D □

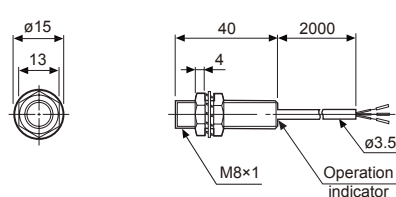

### ● PRL08-2D □

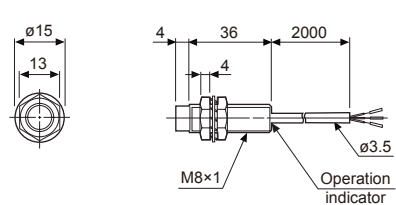

# Cylindrical type Proximity Sensor

## ■ Dimensions

(unit: mm)

### ● PRL12-4D □

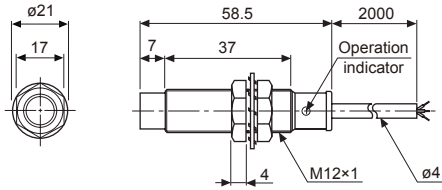

### ● PR12-2A □

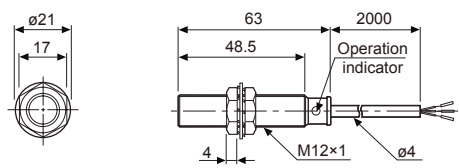

### ● PR12-4A □

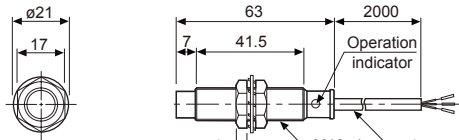

### ● PRL18-5D □ ● PRL18-5A □

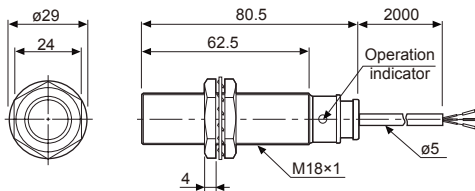

### ● PR18-5A □

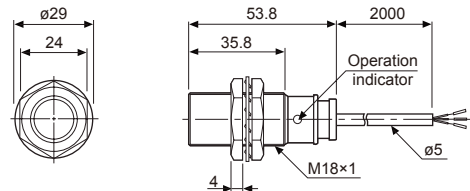

### ● PRL18-8D □ ● PRL18-8A □

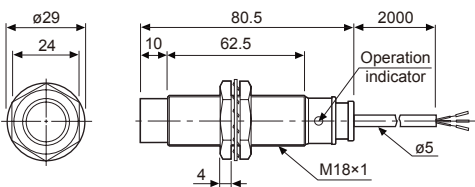

### ● PR18-8A □

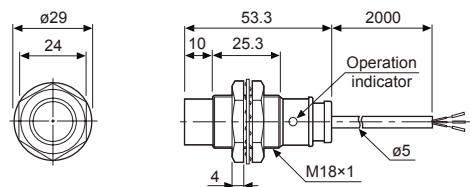

### ● PRL30-10D □ ● PRL30-10A □

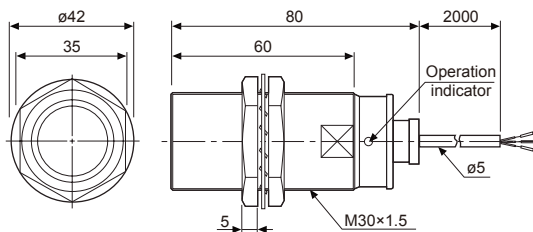

### ● PR30-10A □

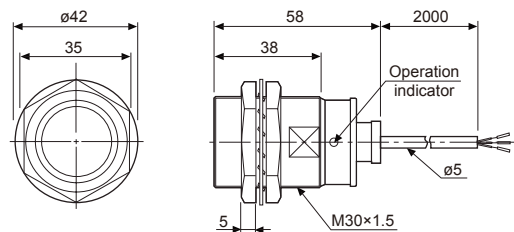

### ● PRL30-15D □ ● PRL30-15A □

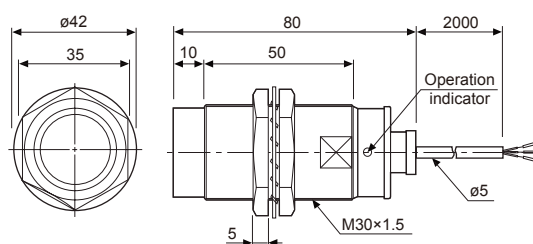

### ● PR30-15A □

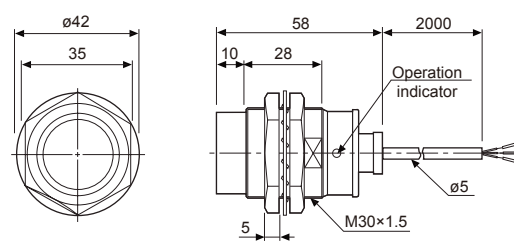

(A)	Photo electric sensor
(B)	Fiber optic sensor
(C)	Door/Area sensor
(D)	Proximity sensor
(E)	Pressure sensor
(F)	Rotary encoder
(G)	Connector/Socket
(H)	Temp. controller
(I)	SSR/Power controller
(J)	Counter
(K)	Timer
(L)	Panel meter
(M)	Tacho/Speed/Pulse meter
(N)	Display unit
(O)	Sensor controller
(P)	Switching mode power supply
(Q)	Stepper motor& Driver&Controller
(R)	Graphic/Logic panel
(S)	Field network device
(T)	Software
(U)	Other

# PR Series

## ■ Control output diagram

### ◎ DC 2-wire type

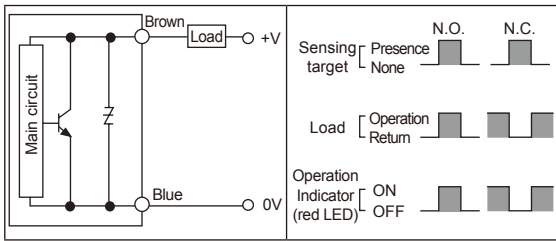

### ◎ DC 3-wire type

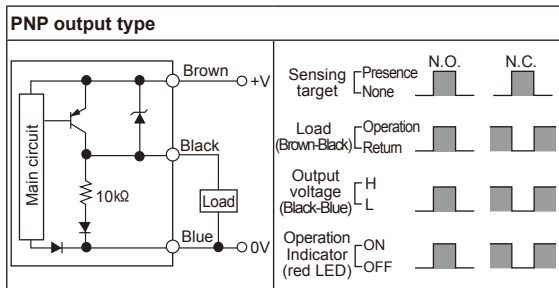
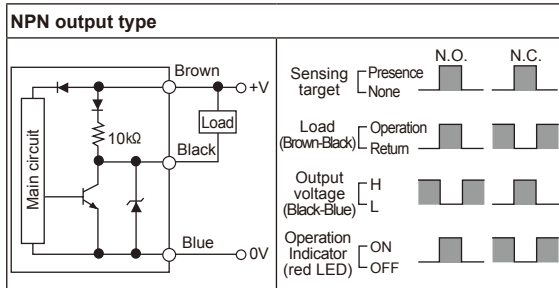

### ◎ AC 2-wire type

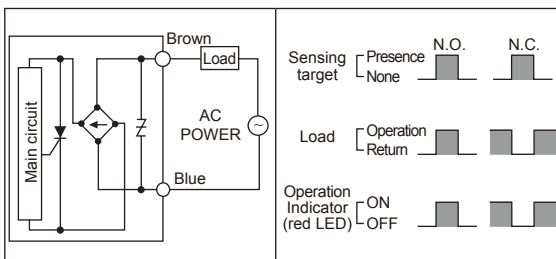

## ■ Connections

### ◎ DC 2-wire type

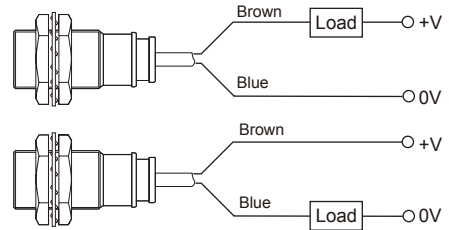

※Load can be wired to any direction.  
 ※No need to consider polarity for non-polarity type of power supply.

### ◎ DC 3-wire type

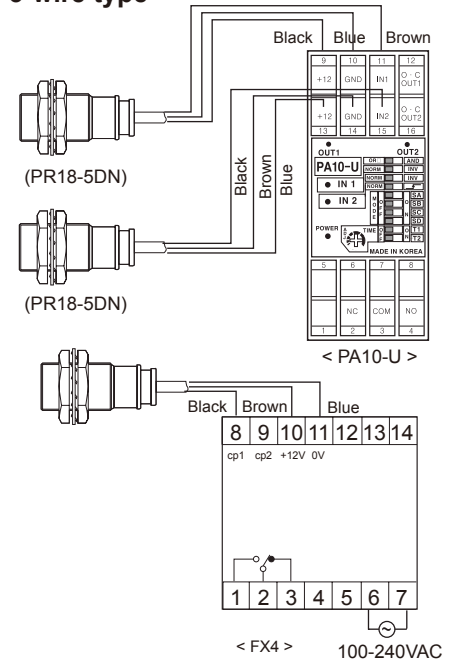

### ◎ AC 2-wire type

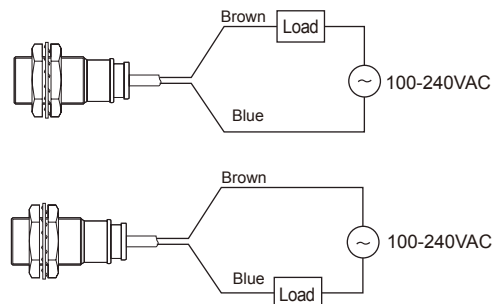

※The load can be connected to either wire.

# Cylindrical type Proximity Sensor

## ■ Proper usage

### ◎ Load connections

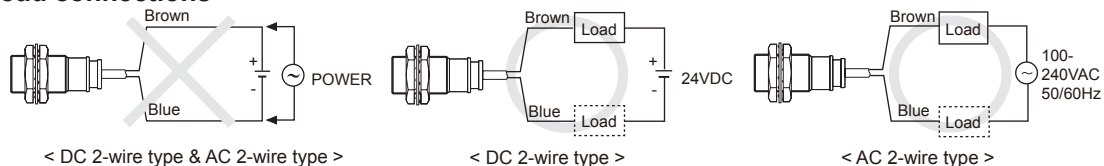

When using DC or AC 2-wire type proximity sensor, the load must be connected, otherwise internal components may be damaged. The load can be connected to either wire.

### ◎ Load connections

#### ● AC 2-wire type

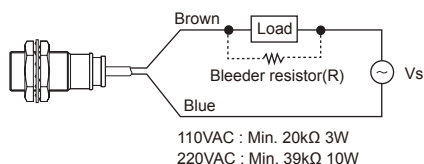

It may cause return failure of load by residual voltage. If the load current is under 5mA, please make sure the residual voltage is less than the return voltage of the load by connecting a bleeder resistor in parallel with the load as shown in the diagram.

$$R = \frac{V_s}{I} (\Omega) \quad P = \frac{V_s^2}{R} (W)$$

[ I: Action current of load, R: Bleeder resistance, P: Permissible power ]

Please make the current on proximity sensor smaller than the return current of load by connecting a bleeder resistor in parallel.

※ W value of Bleeder resistor should be bigger for proper heat dissipation.

#### ● DC 2-wire type

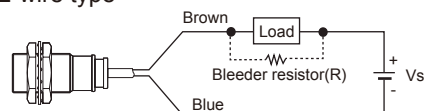

$$R = \frac{V_s}{I_{\text{off}}} (\Omega) \quad P = \frac{V_s^2}{R} (W)$$

[ Vs : Power supply, I<sub>off</sub> : Return current of load, P : Number of Bleeder resistance watt ]

### ◎ Mutual-interference & Influence by surrounding metals

When several proximity sensors are mounted close to one another a malfunction of the may be caused due to mutual interference. Therefore, be sure to keep a minimum distance between the two sensors as below chart indicates.

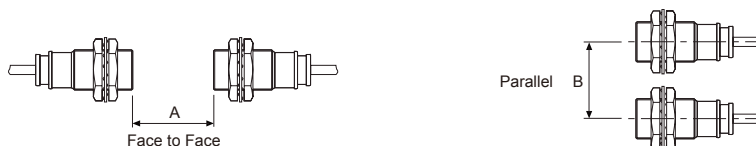

When sensors are mounted on metallic panel, it is required to protect the sensors from being affected by any metallic object except target. Therefore, be sure to provide a minimum distance as below chart indicates.

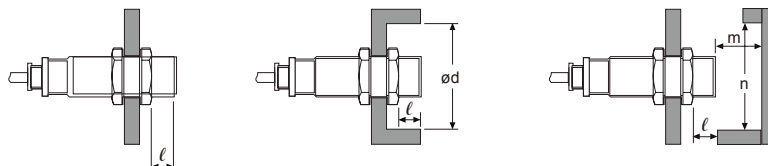

(Unit: mm)

Model	PR08-1.5D□ PRT08-1.5D□	PR08-2D□ PRT08-2D□	PR(T)12-2D□ PRS12-2D□ PR12-2A□	PR(T)12-4D□ PRS12-4D□ PR12-4A□	PR(T)18-5D□ PRL18-5D□ PR18-5A□ PRL18-5A□	PR(T)18-8D□ PRL18-8D□ PR18-8A□ PRL18-8A□	PR(T)30-10D□ PRL30-10D□ PR30-10A□ PRL30-10A□	PR(T)30-15D□ PRL30-15D□ PR30-15A□ PRL30-15A□
A	9	12	12	24	30	48	60	90
B	16	24	24	36	36	54	60	90
ℓ	0	8	0	11	0	14	0	15
ød	8	24	12	36	18	54	30	90
m	4.5	6	6	12	15	24	30	45
n	12	24	18	36	27	54	45	90

(A) Photo electric sensor

(B) Fiber optic sensor

(C) Door/Area sensor

(D) Proximity sensor

(E) Pressure sensor

(F) Rotary encoder

(G) Connector/Socket

(H) Temp. controller

(I) SSR/Power controller

(J) Counter

(K) Timer

(L) Panel meter

(M) Tacho/Speed/Pulse meter

(N) Display unit

(O) Sensor controller

(P) Switching mode power supply

(Q) Stepper motor & Driver & Controller

(R) Graphic/Logic panel

(S) Field network device

(T) Software

(U) Other