

FEATURES:

- I/O Isolation 4000VAC
- Operating Temp: -40 °C to +80 °C or -25 °C to +80 °C
- Input: 90-264VAC, 47-440Hz, or 120-370VDC
- Over load, Over Voltage, Short Circuit Protection
- RoHS compliant
- Energy Star compliant
- Ultra small package
- Soft start



Models
Single output

Model	Input Voltage (VAC/Hz)	Input Voltage (VDC)	Temperature range (°C)	Output Voltage (V)	Output Current max (A)	Maximum capacitive Load (µF)	Efficiency (%)
AMEL5-3.3SMAZ	90-264/47-440	120-370	-25 to +80	3.3	1.5	2200	68
AMEL5-5SMAZ	90-264/47-440	120-370	-25 to +80	5	1	1100	70
AMEL5-12SMAZ	90-264/47-440	120-370	-25 to +80	12	0.42	680	73
AMEL5-15SMAZ	90-264/47-440	120-370	-25 to +80	15	0.333	330	73
AMEL5-24SMAZ	90-264/47-440	120-370	-25 to +80	24	0.21	220	75
AMEL5-3.3SEMAZ	90-264/47-440	120-370	-40 to +80	3.3	1.5	2200	68
AMEL5-5SEMAZ	90-264/47-440	120-370	-40 to +80	5	1	1100	70
AMEL5-12SEMAZ	90-264/47-440	120-370	-40 to +80	12	0.42	680	73
AMEL5-15SEMAZ	90-264/47-440	120-370	-40 to +80	15	0.333	330	73
AMEL5-24SEMAZ	90-264/47-440	120-370	-40 to +80	24	0.21	220	75

Models
Dual output

Model	Input Voltage (VAC, Hz)	Input Voltage (VDC)	Temperature range (°C)	Output Voltage (V)	Output Current max (A)	Maximum capacitive load (µF)	Efficiency (%)
AMEL5-5DMAZ	90-264/47-440	120-370	-25 to +80	±5	±0.5	±470	72
AMEL5-12DMAZ	90-264/47-440	120-370	-25 to +80	±12	±0.21	±220	73
AMEL5-15DMAZ	90-264/47-440	120-370	-25 to +80	±15	±0.168	±150	75
AMEL5-5DEMAZ	90-264/47-440	120-370	-40 to +80	±5	±0.5	±470	72
AMEL5-12DEMAZ	90-264/47-440	120-370	-40 to +80	±12	±0.21	±220	73
AMEL5-15DEMAZ	90-264/47-440	120-370	-40 to +80	±15	±0.168	±150	75

Input Specifications

Parameters	Conditions	Typical	Maximum	Units
Current (full load)	115 VAC		120	mA
	230 VAC		70	mA
Inrush current <2ms (cold start)	115 VAC		10	A
	230 VAC		20	A
Leakage current			0.2	mA
External fuse	Recommended slow blow type	1.5		A
Input Dissipation (No Load)		<0.3		W
Start up time	Soft Start	15		mS
Under Voltage Protection		89		VAC

Output Specifications

Parameters	Conditions	Typical	Maximum	Units
Voltage accuracy		±2		%
Line regulation		±0.5		%
Load regulation (single output)	0-100% load	±0.5		%
Cross Regulation (dual output)	25% load - 1 st out, 100% load – 2 nd out	±5		%
Transient Recovery Time		200		µs
Transient Response Deviation	25% load step	±2		% of Vout
Minimum load		0		%
Ripple & Noise	20MHz bandwidth	100		mV p-p
Hold-up time (minimum)		15		ms

Isolation Specifications

Parameters	Conditions	Typical	Rated	Units
Tested I/O voltage	3sec		4000	VAC
Isolation Resistance		>1000		MΩ

General Specifications

Parameters	Conditions	Typical	Maximum	Units
Switching frequency		132		KHz
Start up time		900		mS
Over Load protection	Auto recovery, hiccup mode	>116%		
Over voltage protection		Zener diode clamp		
Short circuit protection		Continuous		
Short Circuit restart		Auto recovery		
Operating temperature	With derating above 50°C	Refer to the models table above		°C
Storage temperature		-40 to +95		°C
Maximum Case temperature			100	°C
Temperature coefficient		0.02		% / °C
Cooling	Free air convection			
Humidity	Non condensing	20 ~ 95		% RH
Case material		Plastic resin + Fiberglass (flammability to UL 94V-0)		
Weight		30		g
Dimensions (L x W x H)		2.03 x 1.10 x 0.70 inches	51.5 x 28 x 17.8mm	
MTBF		> 400 000 hrs (MIL-HDBK -217F, t _a +25°C)		

NOTE: All specifications in this datasheet are measured at an ambient temperature of 25°C, humidity<75%, nominal input voltage and at rated output load unless otherwise specified.

Environment Approval

Parameters	Conditions
Shock	Wave form: Half sine wave
	Acceleration amplitude: 5gn
	Bump duration: 30 ms
	Number of bumps: 18 (3 in each direction for every axis)
	Converter operation before and after test, body mounted (on chassis)
Vibrations	Test mode: Sweep sine
	10-100Hz, speed 0.05Hz/s
	Displacement: 1mm
	Acceleration: 3g
	3 loops 30min one cycle, 3h total, every axis tested
Converter operation before and after test, body mounted (on chassis)	

Safety Specifications

Parameters		
Agency approvals	cULus, CE, CB	
Standards	Medical Electrical Equipment	IEC/EN/UL 60601-1, CSA-C22.2 No. 601.1-M90
	Information technology Equipment	EN 60950-1:2006+A11:2009
	EMI - Conducted and radiated emission	EN55011, class B
	Harmonic Current Emissions	IEC/EN 61000-3-2, (EN60555-2)
	Voltage fluctuations and flicker	IEC/EN 61000-3-3, (EN60555-3)
	Electrostatic Discharge Immunity	IEC 61000-4-2
	RF, Electromagnetic Field Immunity	IEC 61000-4-3
	Electrical Fast Transient/Burst Immunity	IEC 61000-4-4
	Surge Immunity	IEC 61000-4-5
	RF, Conducted Disturbance Immunity	IEC 61000-4-6
	Power frequency Magnetic Field Immunity	IEC 61000-4-8
Voltage dips, Short Interruptions Immunity	IEC 61000-4-11	

Pin Out Specifications

Pin	Single	Dual
1	AC Input (N)	AC Input (N)
2	AC Input (L)	AC Input (L)
3	+V Output	+V Output
4	-V Output	Common
5	No pin	-V Output

Dimensions

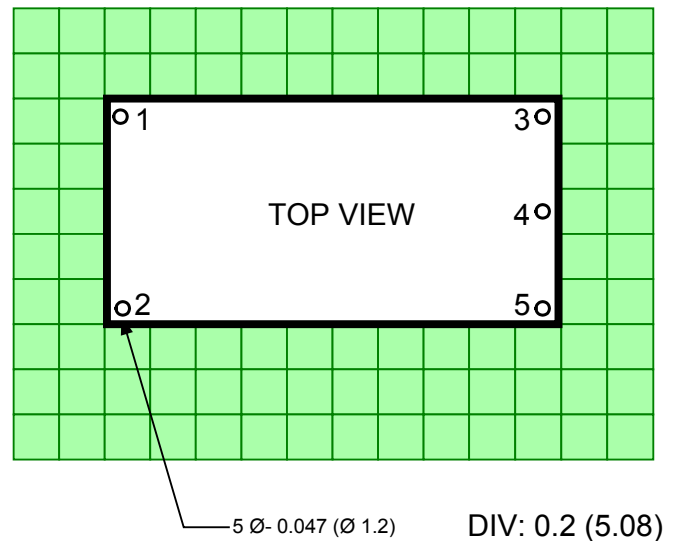
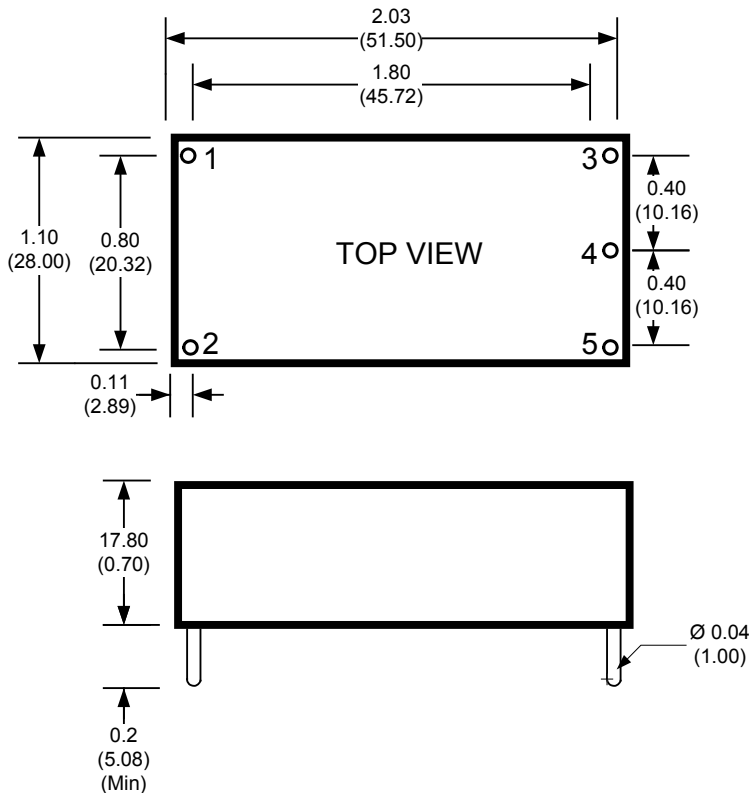

Dimensions: inch (mm)
Case Tolerance: ± 0.012 (0.30)
Pin Pitch Tolerance: ± 0.012 (0.30)

Derating

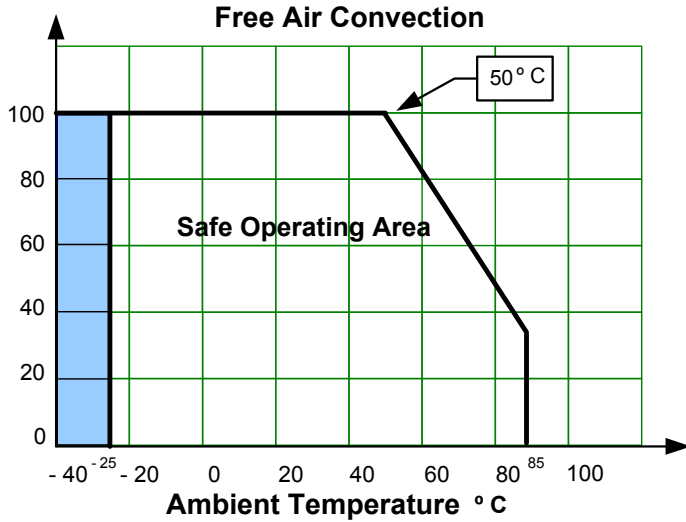

NOTE: **1.** Datasheets are updated as needed and as such, specifications are subject to change without notice. Once printed or downloaded, datasheets are no longer controlled by Aimtec; refer to www.aimtec.com for the most current product specifications. **2.** Product labels shown, including safety agency certifications on labels, may vary based on the date manufactured. **3.** Mechanical drawings and specifications are for reference only. **4.** All specifications are measured at an ambient temperature of 25°C, humidity < 75%, nominal input voltage and at rated output load unless otherwise specified. **5.** Aimtec may not have conducted destructive testing or chemical analysis on all internal components and chemicals at the time of publishing this document. CAS numbers and other limited information are considered proprietary and may not be available for release. **6.** This product is not designed for use in critical life support systems, equipment used in hazardous environments, nuclear control systems or other such applications which necessitate specific safety and regulatory standards other than the ones listed in this datasheet. **7.** Warranty is in accordance with Aimtec's standard Terms of Sale available at www.aimtec.com.