

Features

- Glass Passivated Die Construction
- Super-Fast Recovery Time For High Efficiency
- Low Forward Voltage Drop and High Current Capability
- Surge Overload Rating to 70A Peak
- Ideally Suited for Automated Assembly
- Plastic Material: UL Flammability Classification Rating 94V-0

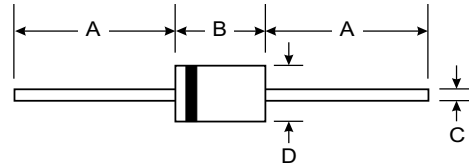

Mechanical Data

- Case: Molded Plastic
- Terminals: Solder Plated Terminal - Solderable per MIL-STD-202, Method 208
- Marking: R460
- Polarity: Cathode Band
- Weight: 1.12 grams (approx.)
- Mounting Position: Any

DO-201AD		
Dim	Min	Max
A	25.40	—
B	7.20	9.50
C	1.20	1.30
D	4.80	5.30
All Dimensions in mm		

Maximum Ratings and Electrical Characteristics

@ T_A = 25°C unless otherwise specified

Single phase, half wave, 60Hz, resistive or inductive load.
For capacitive load, derate current by 20%.

Characteristic	Symbol	MUR460	Unit
Peak Repetitive Reverse Voltage Working Peak Reverse Voltage DC Blocking Voltage	V _{RRM} V _{RWM} V _R	600	V
RMS Reverse Voltage	V _{R(RMS)}	424	V
Average Rectified Output Current @ T _T = 40°C	I _O	4.0	A
Non-Repetitive Peak Forward Surge Current 8.3ms Single half sine-wave Superimposed on Rated Load (JEDEC Method)	I _{FSM}	70	A
Forward Voltage @ I _F = 3.0A, T _J = 150°C @ I _F = 3.0A, T _J = 25°C @ I _F = 4.0A, T _J = 25°C	V _{FM}	1.05 1.25 1.28	V
Peak Reverse Current at Rated DC Blocking Voltage @ T _A = 25°C @ T _A = 150°C	I _{RM}	10 250	μA
Reverse Recovery Time (Note 2)	t _{rr}	50	ns
Forward Recovery Time (Note 3)	t _{fr}	50	ns
Typical Junction Capacitance (Note 1)	C _j	75	pF
Typical Thermal Resistance, Junction to Ambient (Note 4)	R _{θJA}	52	K/W
Operating and Storage Temperature Range	T _j , T _{STG}	-65 to +175	°C

- Notes:
1. Measured at 1.0MHz and applied reverse voltage of 4V DC.
 2. Measured with I_F = 0.5A, I_R = 1.0A, I_{rr} = 0.25A. See Figure 5.
 3. Measured with I_F = 1.0A, di/dt = 100A/μs, Duty Cycle ≤ 2.0%.
 4. Mounted to PCB, lead length = 9.5mm.

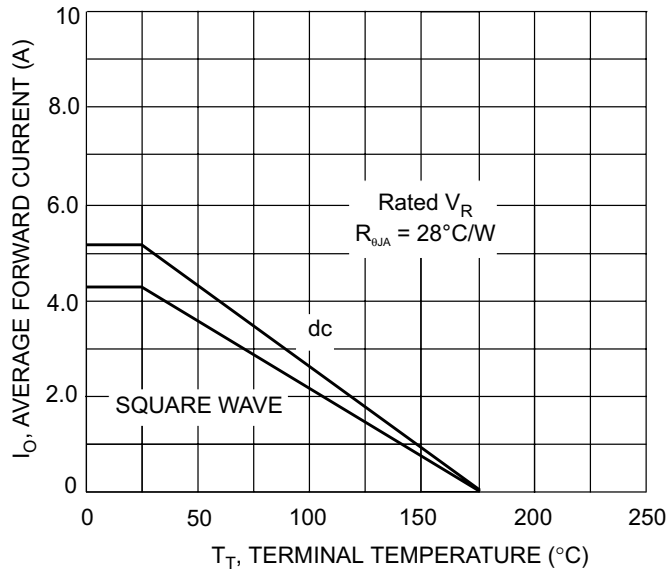

Fig. 1 Forward Current Derating Curve

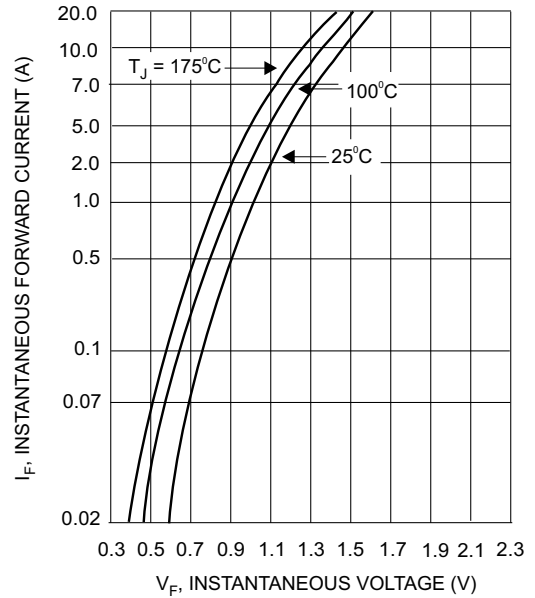

Fig. 2 Typical Forward Characteristics

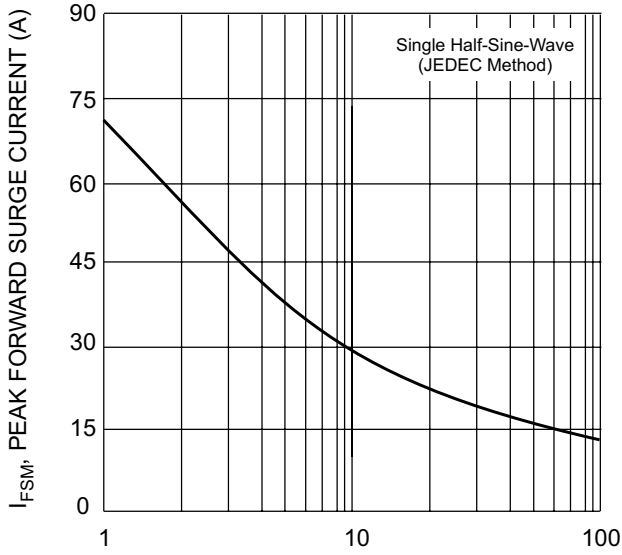

Fig. 3 Surge Current Derating Curve

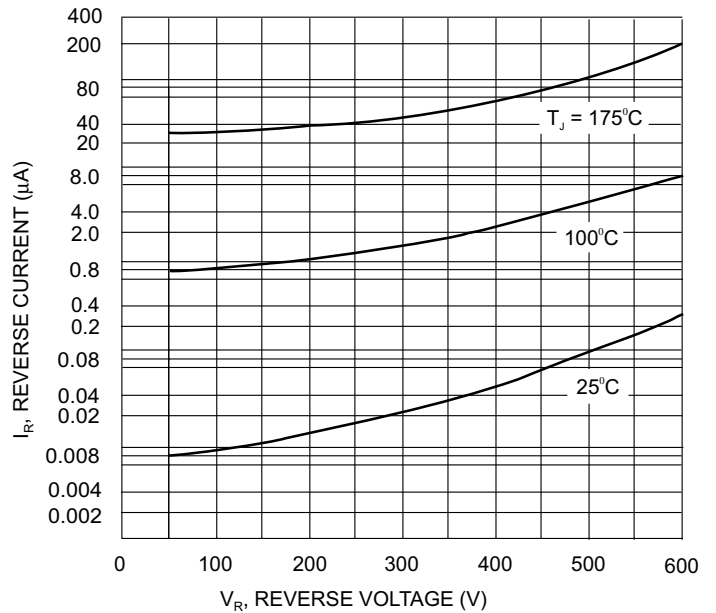
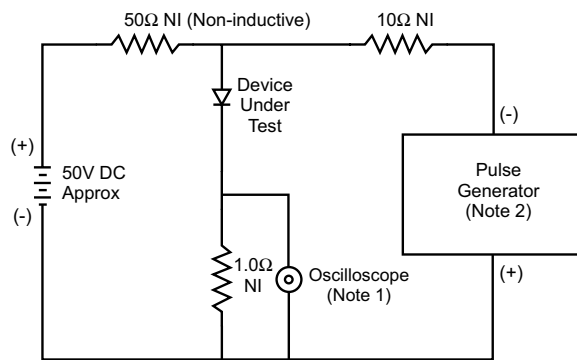
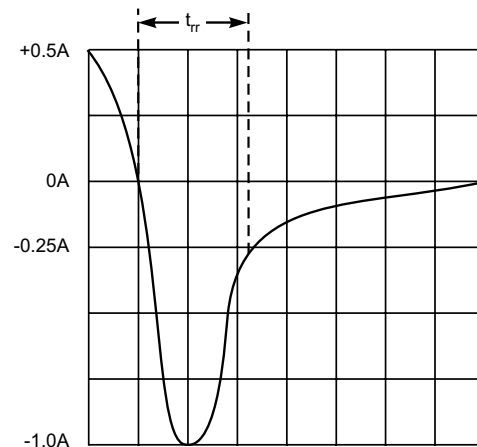

Fig. 4 Typical Reverse Characteristics



- Notes:
1. Rise Time = 7.0ns max. Input Impedance = 1.0MΩ, 22pF.
 2. Rise Time = 10ns max. Input Impedance = 50Ω.



Set time base for 50/100 ns/cm

Fig. 5 Reverse Recovery Time Characteristic and Test Circuit