

REV.	DESCRIPTION	DRAWN	CHECKED	APPROVED
A	NEW RELEASE	LJH 09/26/05'		LJC 09/26/05'
B	整理图面	YCH 05/26/07'		LJC 05/26/07'
C	增加锁螺丝类型	YCH 06/30/07'		

NOTES:

1. ELECTRICAL CHARACTERISTICS:

- 1.1 CONTACT RESISTANCE: 20mΩ Max. INITIAL.
- 1.2 DIELECTRIC WITHSTANDING VOLTAGE: 500V AC(rms) FOR 1 MINUTE.
- 1.3 INSULATION RESISTANCE: 1000MΩ Min.

2. ENVIRONMENT CHARACTERISTICS:

TEMPERATURE RANGE: -45°C~+105°C.

3. PART NUMBER: DS1035

4. PRODUCT NUMBER CODE:

DS1035- X X X X X X X

SCREW DIM. A

S: Standard(W/O nut)

1: 3.00

2: 4.00

3: 4.50

4: 5.00

5: 5.50

6: 5.80

SCREW TYPE

S: Standard(W/O nut)

1: CC TYPE

2: CS TYPE

3: BR TYPE

4: BRJ TYPE DIM. A:5.80 B:6.00 C: 3~4

5: BRJ TYPE DIM. A:5.80 B:6.00 C: 5~6

CONTACT PLATING

8: FULL GOLD FLASH

Si: SELECTIVE GOLD FLASH

SHELL PLATING

T: FORNT & BACK SHELL TIN

N: FORNT SHELL NICKEL, BACK SHELL TIN

HOUSING COLOR

B: BLACK

W: WHITE

U: BLUE

CONNECTOR TYPE

M: MALE

F: FEMALE

No.OF CONTACTS

15: 15pos.

26: 26pos.

44: 44pos.

62: 62pos.

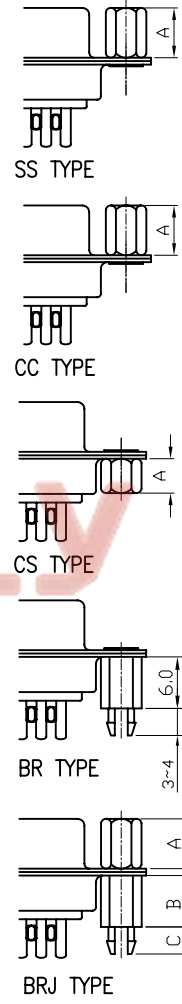
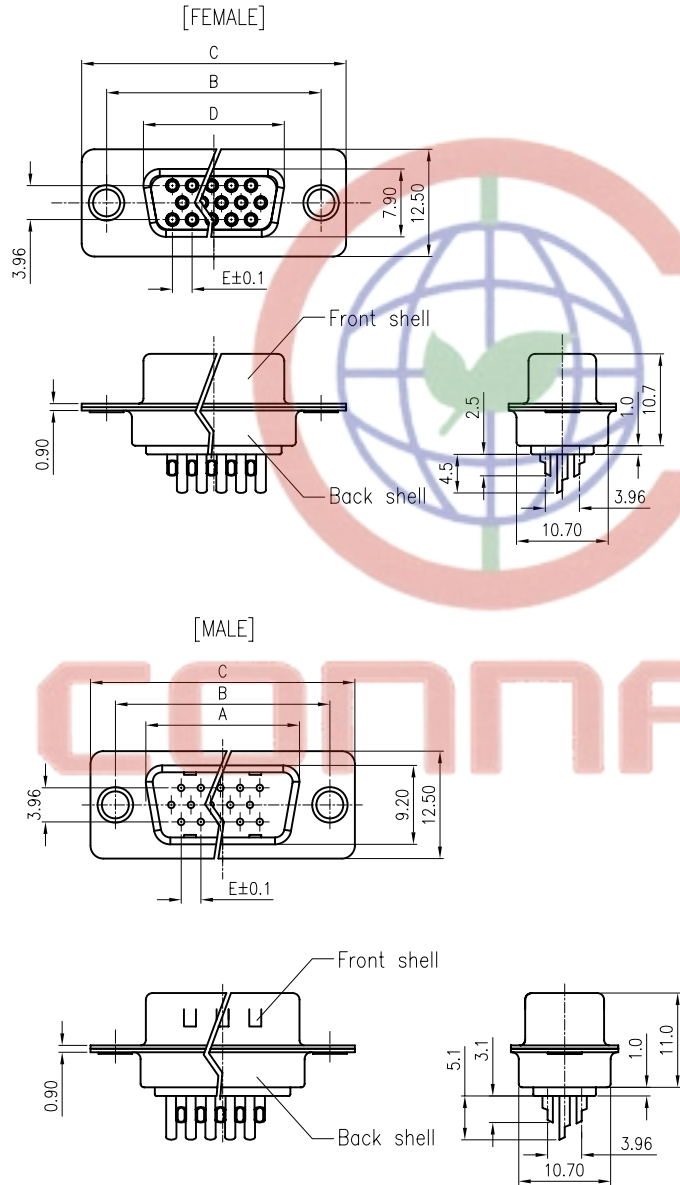

Dimension

Position	A±0.2	B±0.2	C±0.3	D	E
15	17.90	24.99	30.80	16.33	2.29
26	26.50	33.32	39.14	24.66	2.29
44	40.00	47.04	53.04	38.38	2.29
62	56.50	63.50	69.32	54.84	2.14
78	54.30	61.00	67.04	52.34	2.14

GENERAL TOLERANCE

X.	±0.60
.X	±0.38
.XX	±0.25

ANGLE TOLERANCE

X.	±5'
.X	±3'
.XX	±2'

PROJECTION



UNITS

mm

SHEET SIZE

A4

TITLE

DS1035 SERIES

SERIES

DS1035 SERIES

D-SUB H.D SOLDER TYPE

DRAWING TYPE

SCALE

DRAWING NO.

CUSTOMER

1:1

C-DS1035-XXXXXXX

SHEET

1 OF 1

Tel: 86-574-63508787

Fax: 86-574-63510817

Email: sales@connfly.com.cn

<http://www.connfly.com.cn>

Address: West China, Chengde, Sichuan, China



晨翔电子有限公司

CONNFLY CONNFLY ELECTRONIC CO. LTD

REV.	DESCRIPTION	DRAWN	CHECKED	APPROVED
A	NEW RELEASE	LL 12/06/06'		LJC 12/06/06'
B	增加锁螺丝类型	YCH 06/30/07'		

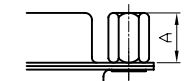
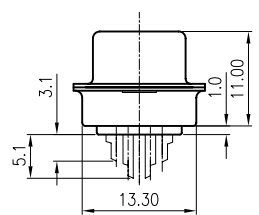
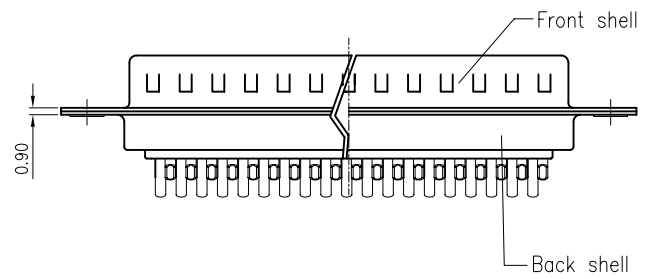
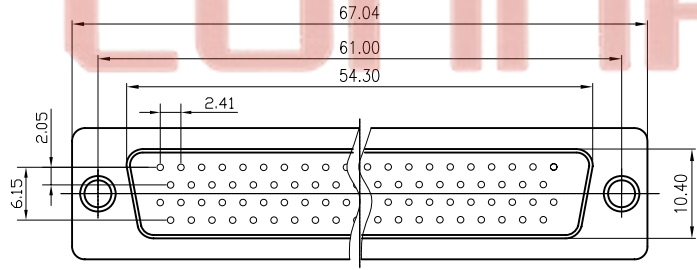
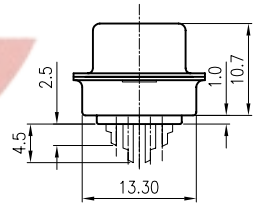
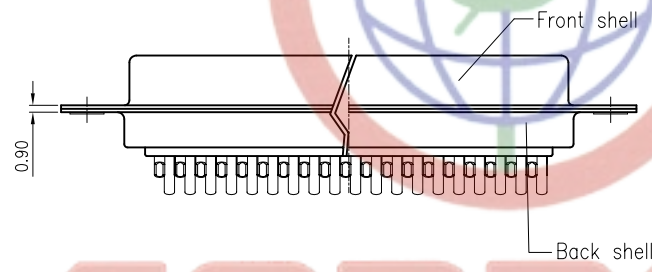
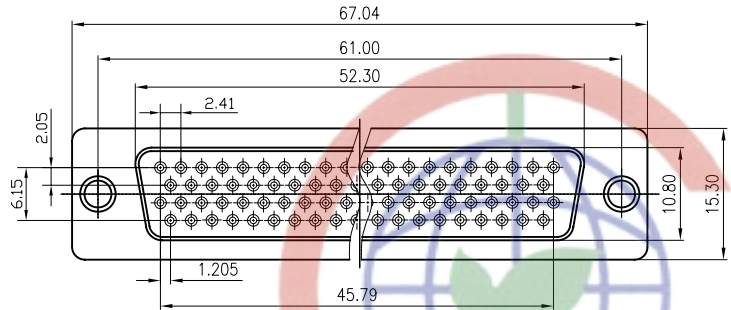

SS TYPE

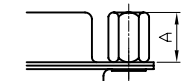

CC TYPE

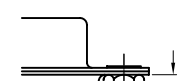

CS TYPE



BR TYPE

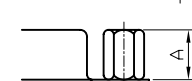

BRJ TYPE

NOTES:

- ELECTRICAL CHARACTERISTICS:
 - CONTACT RESISTANCE: 20mΩ Max. INITIAL.
 - DIELECTRIC WITHSTANDING VOLTAGE: 500V AC(rms) FOR 1 MINUTE.
 - INSULATION RESISTANCE: 1000MΩ Min.
- ENVIRONMENT CHARACTERISTICS:

TEMPERATURE RANGE: -45°C~+105°C.
- PRODUCT NUMBER CODE:

DS1035- X X X X X X X

 - SCREW DIM. A
 - S: Standard(W/O nut)
 - 1: 3.00
 - 2: 4.00
 - 3: 4.50
 - 4: 5.00
 - 5: 5.50
 - 6: 5.80
 - SCREW TYPE
 - S: Standard(W/O nut)
 - 1: CC TYPE
 - 2: CS TYPE
 - 3: BR TYPE
 - 4: BRJ TYPE DIM. A:5.80 B:6.00 C: 3~4
 - 5: BRJ TYPE DIM. A:5.80 B:6.00 C: 5~6
 - CONTACT PLATING
 - 8: FULL GOLD FLASH
 - Si: SELECTIVE GOLD FLASH
 - SHELL PLATING
 - T: FORNT & BACK SHELL TIN
 - N: FORNT SHELL NICKEL, BACK SHELL TIN
 - HOUSING COLOR
 - B: BLACK
 - W: WHITE
 - U: BLUE
 - CONNECTOR TYPE
 - M: MALE
 - F: FEMALE
 - No.OF CONTACTS
 - 78: 78pos.

GENERAL TOLERANCE		ANGLE TOLERANCE		PROJECTION	TITLE
X.	±0.60	X.	±5°		D-SUB H.D SOLDER TYPE
.X	±0.38	.X	±3°	mm	
.XX	±0.25	.XX	±2°	A4	SERIES DS1035 SERIES
DRAWING TYPE	CUSTOMER	晨翔电子有限公司 CONNFLY CONNFLY ELECTRONIC CO. LTD			
SCALE	1:1	SHEET	1 OF 1		
DRAWING NO.	C-DS1035-78XXXXXX				