

Selection Guide

Part No.	Dice	Lens Type	Iv (ucd) [1] @ 10mA		Description
			Min.	Typ.	
SA56-11GWA	Green (GaP)	WHITE DIFFUSED	1900	10500	Common Anode, Rt. Hand Decimal.

Note:

1. Luminous intensity/ luminous Flux: +/-15%.

Electrical / Optical Characteristics at TA=25°C

Symbol	Parameter	Device	Typ.	Max.	Units	Test Conditions
λ_{peak}	Peak Wavelength	Green	565		nm	I _F =20mA
λ_D [1]	Dominant Wavelength	Green	568		nm	I _F =20mA
$\Delta\lambda_{1/2}$	Spectral Line Half-width	Green	30		nm	I _F =20mA
C	Capacitance	Green	15		pF	V _F =0V;f=1MHz
V _F [2]	Forward Voltage	Green	2.2	2.5	V	I _F =20mA
I _R	Reverse Current	Green		10	uA	V _R =5V

Notes:

1. Wavelength: +/-1nm.
2. Forward Voltage: +/-0.1V.

Absolute Maximum Ratings at TA=25°C

Parameter	Green	Units
Power dissipation	62.5	mW
DC Forward Current	25	mA
Peak Forward Current [1]	140	mA
Reverse Voltage	5	V
Operating / Storage Temperature	-40°C To +85°C	
Lead Solder Temperature[2]	260°C For 3-5 Seconds	

Notes:

1. 1/10 Duty Cycle, 0.1ms Pulse Width.
2. 2mm below package base.

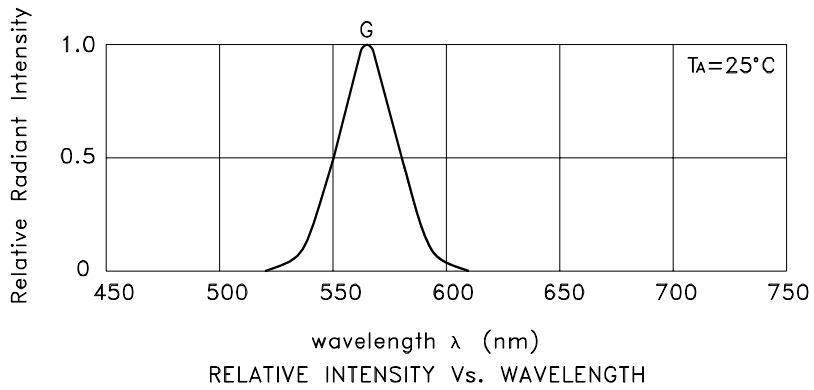

Green

SA56-11GWA

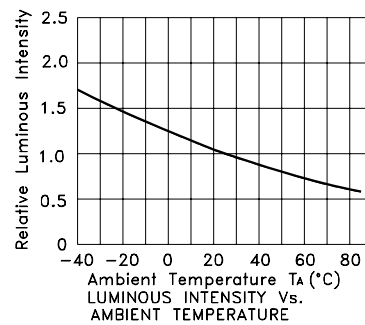
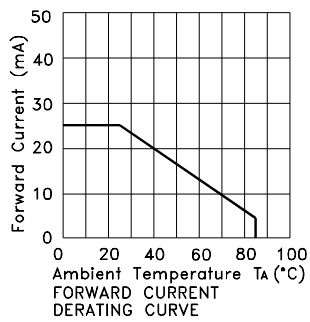
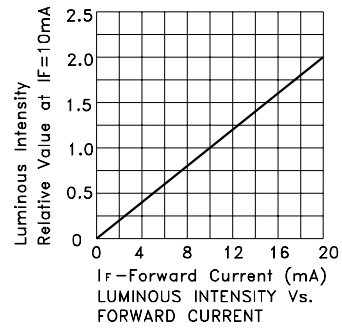
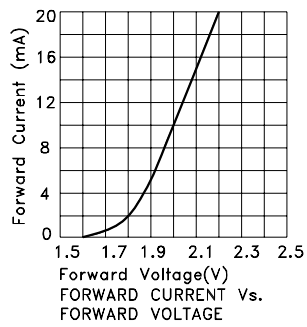

PACKING & LABEL SPECIFICATIONS

SA56-11GWA

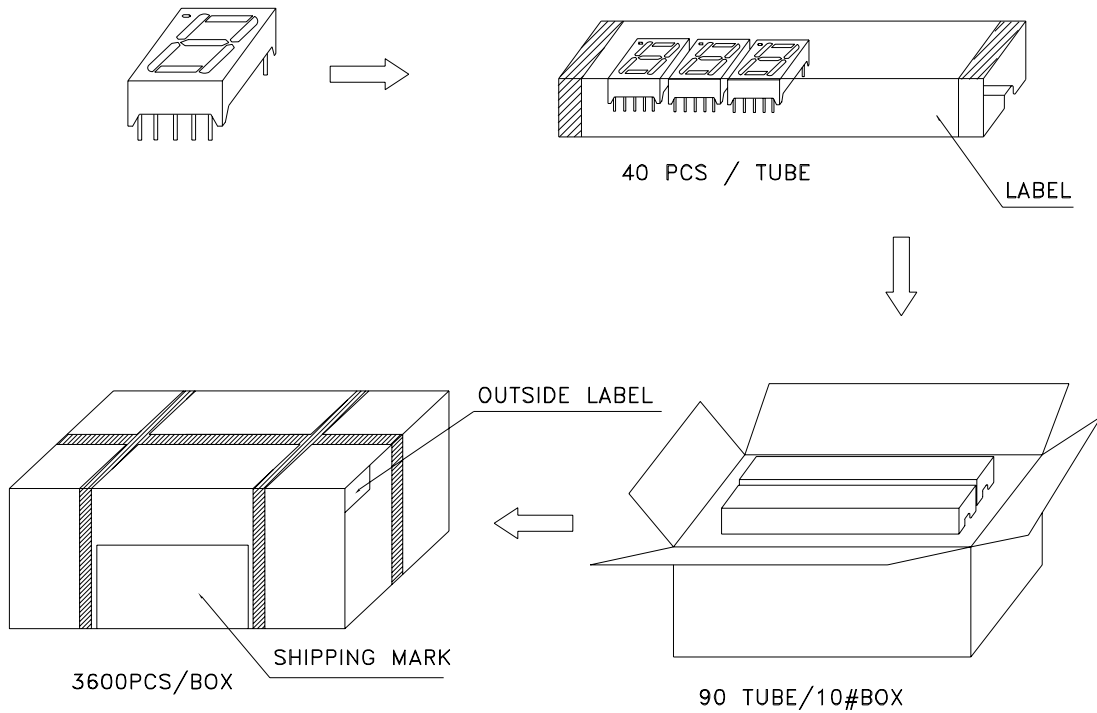

Inside LABEL Paste On The IC-TUBE

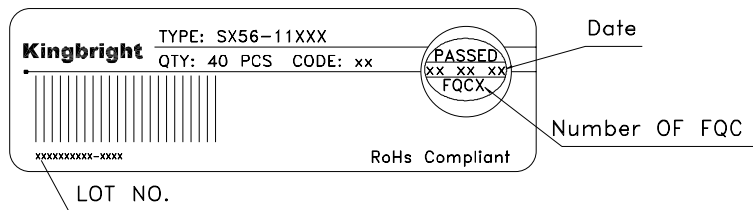

Outside LABEL Paste On The Box

