

Part Number: TBA20-12EGWA HIGH EFFICIENCY RED GREEN

### Features

- 2.0 INCH MATRIX HEIGHT.
- DOT SIZE 5mm.
- LOW CURRENT OPERATION.
- HIGH CONTRAST AND LIGHT OUTPUT.
- STACKABLE HORIZONTALLY.
- EASY MOUNTING ON P.C. BOARDS OR SOCKETS.
- CATEGORIZED FOR LUMINOUS INTENSITY.
- MECHANICALLY RUGGED.
- STANDARD : GRAY FACE, WHITE DOT.
- RoHS COMPLIANT.

### Description

The High Efficiency Red source color devices are made With Gallium Arsenide Phosphide on Gallium Phosphide Orange Light Emitting Diode.

The Green source color devices are made with Gallium Phosphide Green Light Emitting Diode.

### Package Dimensions & Internal Circuit Diagram

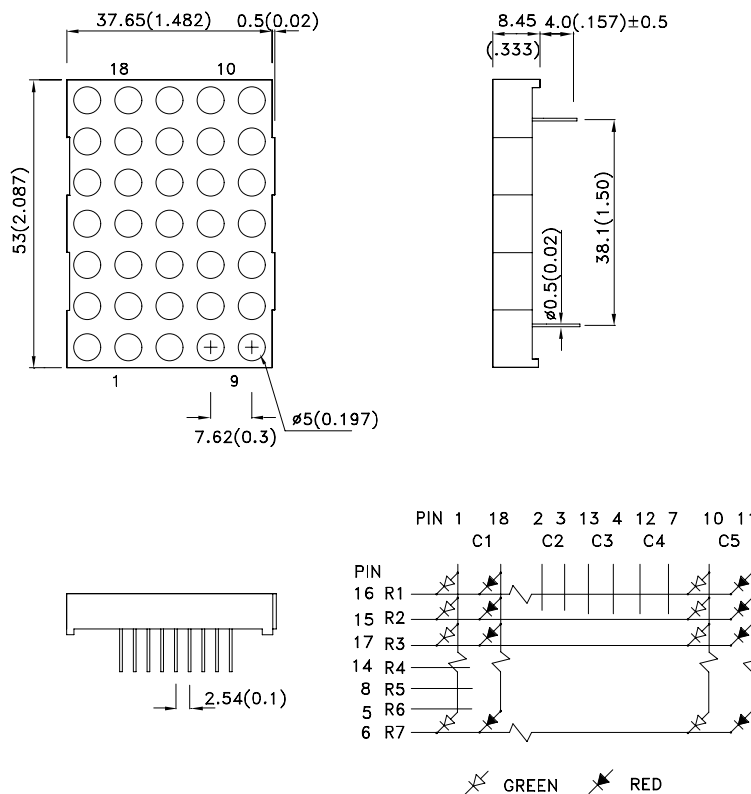

**Notes:**

1. All dimensions are in millimeters (inches), Tolerance is  $\pm 0.25(0.01)$ " unless otherwise noted.
2. Specifications are subject to change without notice.



## Selection Guide

| Part No.     | Dice                            | Lens Type      | Iv (ucd) [1]<br>@ 10mA |       | Description  |
|--------------|---------------------------------|----------------|------------------------|-------|--------------|
|              |                                 |                | Min.                   | Typ.  |              |
| TBA20-12EGWA | HIGH EFFICIENCY RED (GaAsP/GaP) | WHITE DIFFUSED | 3000                   | 12000 | Column Anode |
|              | GREEN (GaP)                     |                | 3000                   | 16000 |              |

Note:

1.Luminous Intensity / Luminous Flux: +/-15%.

## Electrical / Optical Characteristics at TA=25°C

| Symbol                | Parameter                | Device                       | Typ.       | Max.       | Units | Test Conditions           |
|-----------------------|--------------------------|------------------------------|------------|------------|-------|---------------------------|
| $\lambda_{peak}$      | Peak Wavelength          | High Efficiency Red<br>Green | 627<br>565 |            | nm    | I <sub>F</sub> =20mA      |
| $\lambda_D$ [1]       | Dominant Wavelength      | High Efficiency Red<br>Green | 625<br>568 |            | nm    | I <sub>F</sub> =20mA      |
| $\Delta\lambda_{1/2}$ | Spectral Line Half-width | High Efficiency Red<br>Green | 45<br>30   |            | nm    | I <sub>F</sub> =20mA      |
| C                     | Capacitance              | High Efficiency Red<br>Green | 15<br>15   |            | pF    | V <sub>F</sub> =0V;f=1MHz |
| V <sub>F</sub> [2]    | Forward Voltage          | High Efficiency Red<br>Green | 2.0<br>2.2 | 2.5<br>2.5 | V     | I <sub>F</sub> =20mA      |
| I <sub>R</sub>        | Reverse Current          | High Efficiency Red<br>Green |            | 10<br>10   | uA    | V <sub>R</sub> = 5V       |

Notes:

1.Wavelength: +/-1nm

2.Forward Voltage: +/-0.1V

## Absolute Maximum Ratings at TA=25°C

| Parameter                       | High Efficiency Red   | Green | Units |
|---------------------------------|-----------------------|-------|-------|
| Power dissipation               | 75                    | 62.5  | mW    |
| DC Forward Current              | 30                    | 25    | mA    |
| Peak Forward Current [1]        | 160                   | 140   | mA    |
| Reverse Voltage                 | 5                     |       | V     |
| Operating / Storage Temperature | -40°C To +85°C        |       |       |
| Lead Solder Temperature [2]     | 260°C For 3~5 Seconds |       |       |

Notes:

1. 1/10 Duty Cycle, 0.1ms Pulse Width.

2. 2mm below package base.

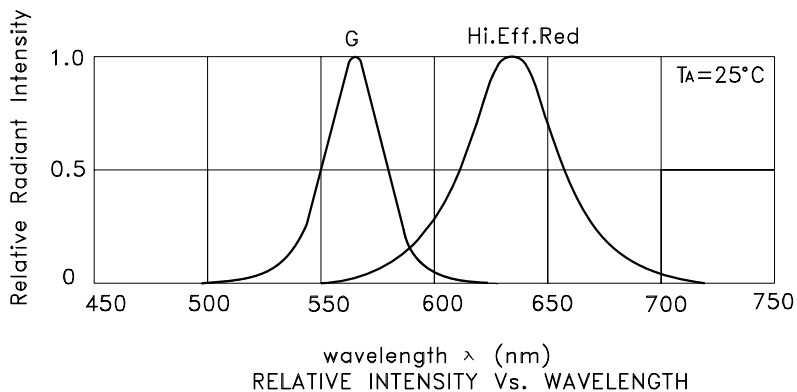

## TBA20-12EGWA High Efficiency Red

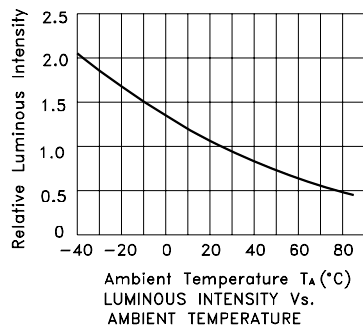
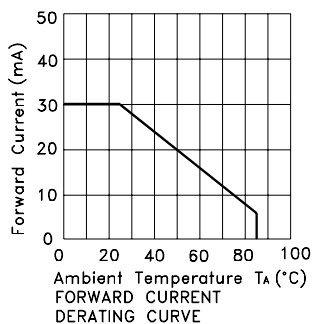
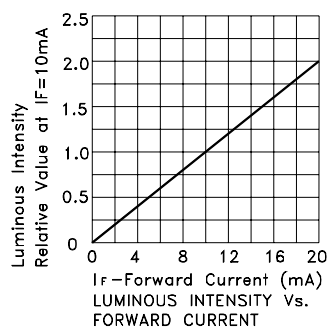
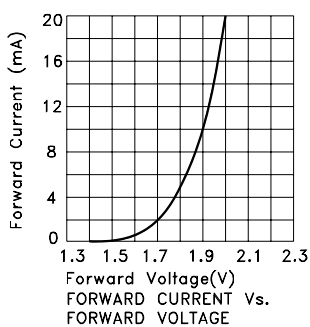

## Green

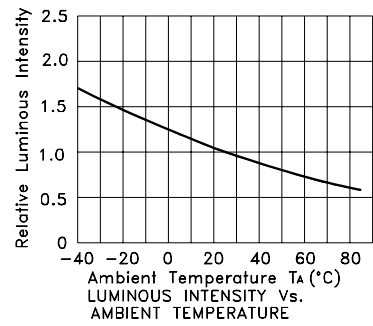
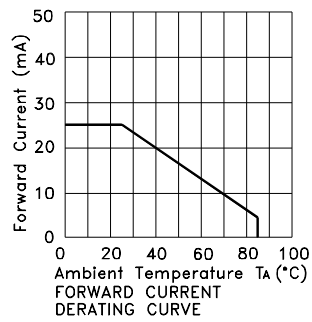
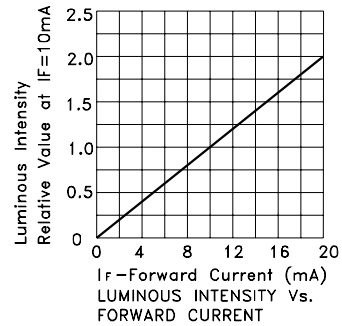
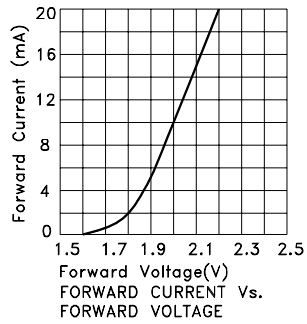

## PACKING & LABEL SPECIFICATIONS

## TBA20-12EGWA

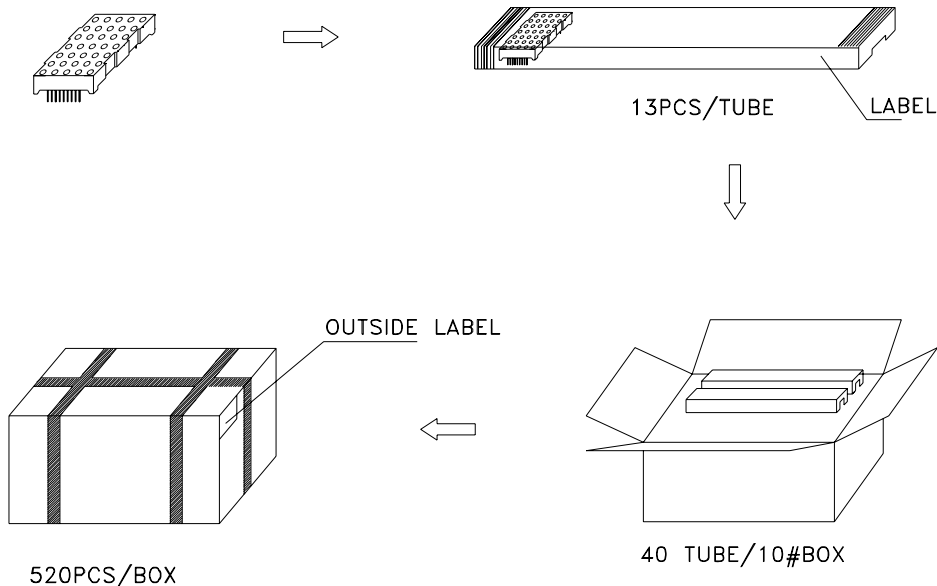

Inside LABEL Paste On The IC-tube

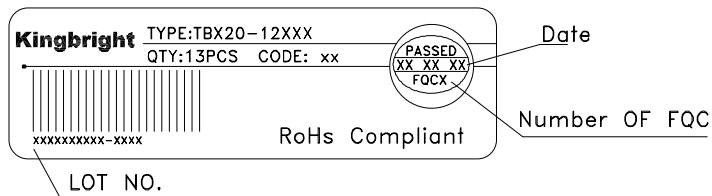

Outside LABEL Paste On The Box

