

- $V_{DS}$  200 V
- $I_D$  0.48 A
- $R_{DS(on)}$  3.5  $\Omega$
- N channel
- Depletion mode
- High dynamic resistance
- Available grouped in  $V_{GS(th)}$

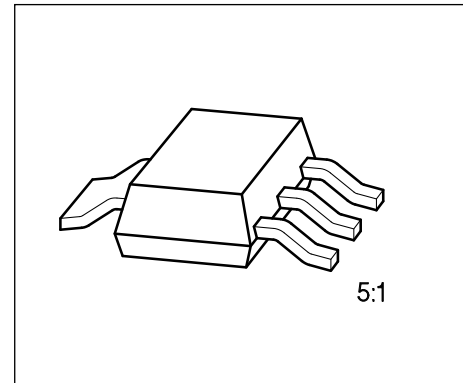

Type	Ordering Code	Tape and Reel Information	Pin Configuration				Marking	Package
			1	2	3	4		
BSP 149	Q67000-S071	E6327: 1000 pcs/reel	G	D	S	D	BSP 149	SOT-223

### Maximum Ratings

Parameter	Symbol	Values	Unit
Drain-source voltage	$V_{DS}$	200	V
Drain-gate voltage, $R_{GS} = 20 \text{ k}\Omega$	$V_{DGR}$	200	
Gate-source voltage	$V_{GS}$	$\pm 14$	
Gate-source peak voltage, aperiodic	$V_{gs}$	$\pm 20$	
Continuous drain current, $T_A = 28 \text{ }^\circ\text{C}$	$I_D$	0.48	A
Pulsed drain current, $T_A = 25 \text{ }^\circ\text{C}$	$I_{D \text{ puls}}$	1.44	
Max. power dissipation, $T_A = 25 \text{ }^\circ\text{C}$	$P_{tot}$	1.8	W
Operating and storage temperature range	$T_j, T_{stg}$	$-55 \dots +150$	$^\circ\text{C}$

Thermal resistance <sup>1)</sup>	chip-ambient	$R_{thJA}$	70	K/W
	chip-soldering point	$R_{thJS}$	10	
DIN humidity category, DIN 40 040	–	–	E	–
IEC climatic category, DIN IEC 68-1	–	–	55/150/56	

<sup>1)</sup> Transistor on epoxy pcb 40 mm × 40 mm × 1.5 mm with 6 cm<sup>2</sup> copper area for drain connection.

## Electrical Characteristics

at  $T_j = 25\text{ °C}$ , unless otherwise specified.

Parameter	Symbol	Values			Unit
		min.	typ.	max.	

### Static Characteristics

Drain-source breakdown voltage $V_{GS} = -3\text{ V}$ , $I_D = 0.25\text{ mA}$	$V_{(BR)DSS}$	200	–	–	V
Gate threshold voltage $V_{DS} = 3\text{ V}$ , $I_D = 1\text{ mA}$	$V_{GS(th)}$	– 1.8	– 1.2	– 0.7	
Drain-source cutoff current $V_{DS} = 200\text{ V}$ , $V_{GS} = -3\text{ V}$ $T_j = 25\text{ °C}$ $T_j = 125\text{ °C}$	$I_{DSS}$	– –	– –	0.2 200	$\mu\text{A}$
Gate-source leakage current $V_{GS} = 20\text{ V}$ , $V_{DS} = 0$	$I_{GSS}$	–	10	100	nA
Drain-source on-resistance $V_{GS} = 0\text{ V}$ , $I_D = 0.03\text{ A}$	$R_{DS(on)}$	–	2.5	3.5	$\Omega$

### Dynamic Characteristics

Forward transconductance $V_{DS} \geq 2 \times I_D \times R_{DS(on)max}$ , $I_D = 0.48\text{ A}$	$g_{fs}$	0.4	0.75	–	S
Input capacitance $V_{GS} = 0$ , $V_{DS} = 25\text{ V}$ , $f = 1\text{ MHz}$	$C_{iss}$	–	500	670	$\mu\text{F}$
Output capacitance $V_{GS} = 0$ , $V_{DS} = 25\text{ V}$ , $f = 1\text{ MHz}$	$C_{oss}$	–	40	60	
Reverse transfer capacitance $V_{GS} = 0$ , $V_{DS} = 25\text{ V}$ , $f = 1\text{ MHz}$	$C_{rss}$	–	12	20	
Turn-on time $t_{on}$ , ( $t_{on} = t_{d(on)} + t_r$ ) $V_{DD} = 30\text{ V}$ , $V_{GS} = -2 \dots +5\text{ V}$ , $R_{GS} = 50\text{ }\Omega$ , $I_D = 0.29\text{ A}$	$t_{d(on)}$	–	7	10	ns
	$t_r$	–	20	30	
Turn-off time $t_{off}$ , ( $t_{off} = t_{d(off)} + t_f$ ) $V_{DD} = 30\text{ V}$ , $V_{GS} = -2 \dots +5\text{ V}$ , $R_{GS} = 50\text{ }\Omega$ , $I_D = 0.29\text{ A}$	$t_{d(off)}$	–	60	80	
	$t_f$	–	50	65	

## Electrical Characteristics (cont'd)

at  $T_j = 25\text{ °C}$ , unless otherwise specified.

Parameter	Symbol	Values			Unit
		min.	typ.	max.	

### Reverse Diode

Continuous reverse drain current $T_A = 25\text{ °C}$	$I_S$	–	–	0.48	A
Pulsed reverse drain current $T_A = 25\text{ °C}$	$I_{SM}$	–	–	1.44	
Diode forward on-voltage $I_F = 0.96\text{ A}$ , $V_{GS} = 0$	$V_{SD}$	–	0.9	1.2	V

$V_{GS(th)}$ Grouping	Symbol	Limit Values		Unit	Test Condition
		min.	max.		
Range of $V_{GS(th)}$	$\Delta V_{GS(th)}$	–	0.15	V	–
Threshold voltage selected in groups <sup>1)</sup> :	$V_{GS(th)}$				$V_{D1} = 0.2\text{ V}$ ; $V_{D2} = 3\text{ V}$ ; $I_D = 1\text{ mA}$
P		– 0.95	– 0.80	V	
R		– 1.08	– 0.93	V	
S		– 1.21	– 1.06	V	
T		– 1.34	– 1.19	V	
U		– 1.47	– 1.32	V	
V		– 1.60	– 1.45	V	
W		– 1.73	– 1.58	V	

1) A specific group cannot be ordered separately.  
Each reel only contains transistors from one group.

### Package Outline

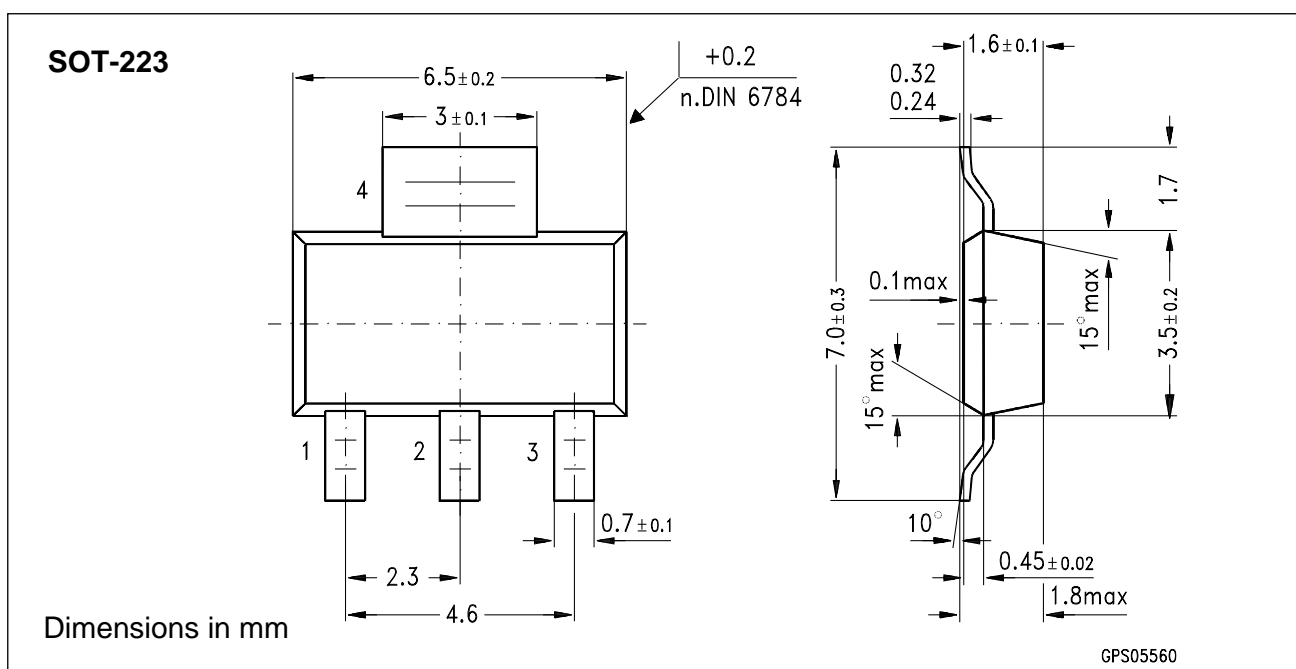

**Characteristics**

at  $T_j = 25\text{ }^\circ\text{C}$ , unless otherwise specified.

**Total power dissipation**  $P_{\text{tot}} = f(T_A)$

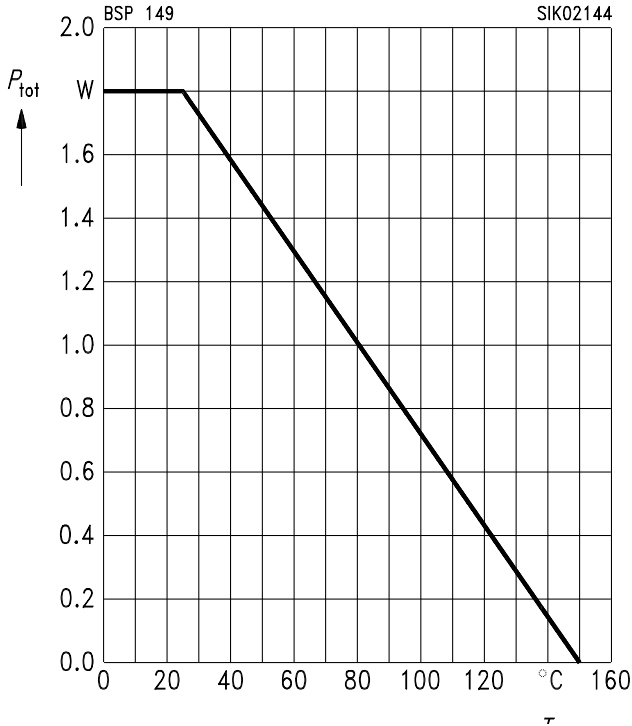

**Safe operating area**  $I_D = f(V_{\text{DS}})$

parameter:  $D = 0.01, T_C = 25\text{ }^\circ\text{C}$

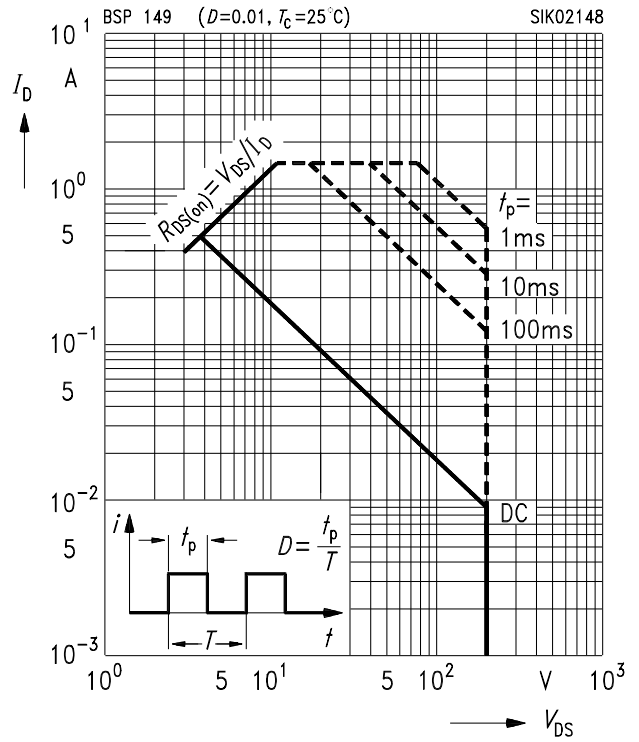

**Typ. output characteristics**  $I_D = f(V_{\text{DS}})$

parameter:  $t_p = 80\text{ }\mu\text{s}$

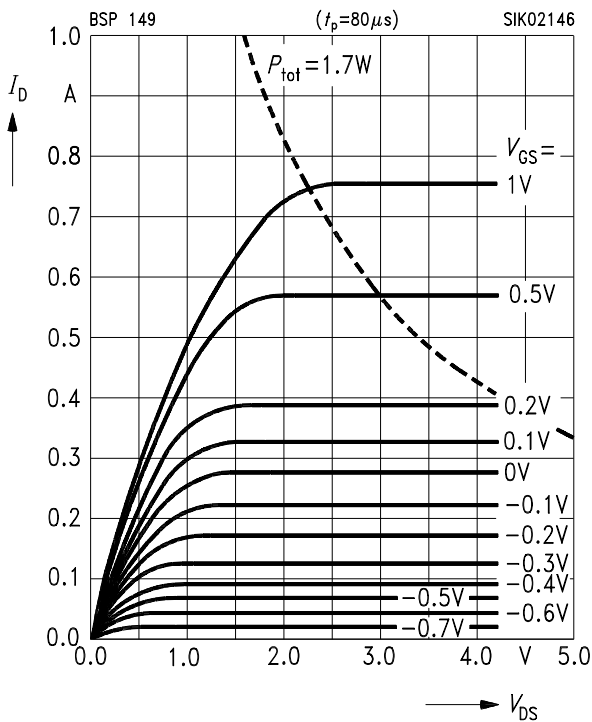

**Typ. drain-source on-resistance**

$R_{\text{DS(on)}} = f(I_D)$

parameter:  $V_{\text{GS}}$

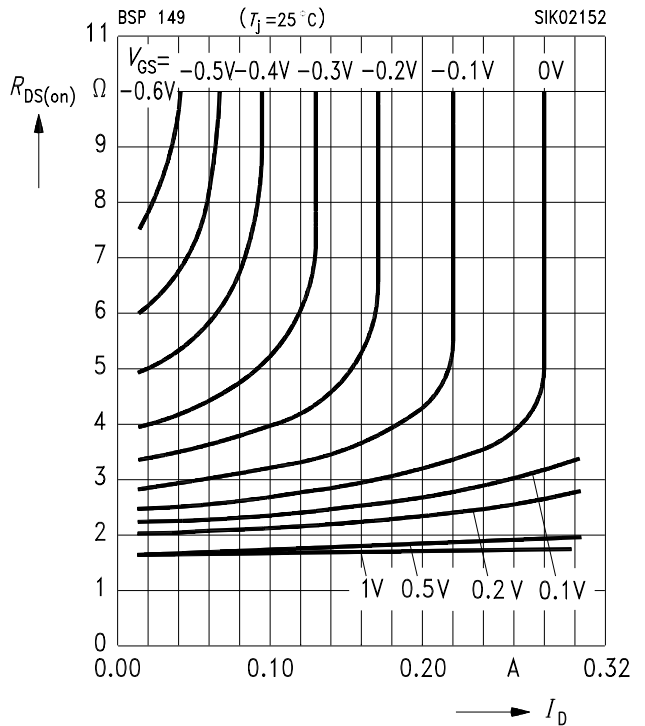

**Typ. transfer characteristics**  $I_D = f(V_{GS})$   
 parameter:  $t_p = 80 \mu s$ ,  $V_{DS} \geq 2 \times I_D \times R_{DS(on)max.}$

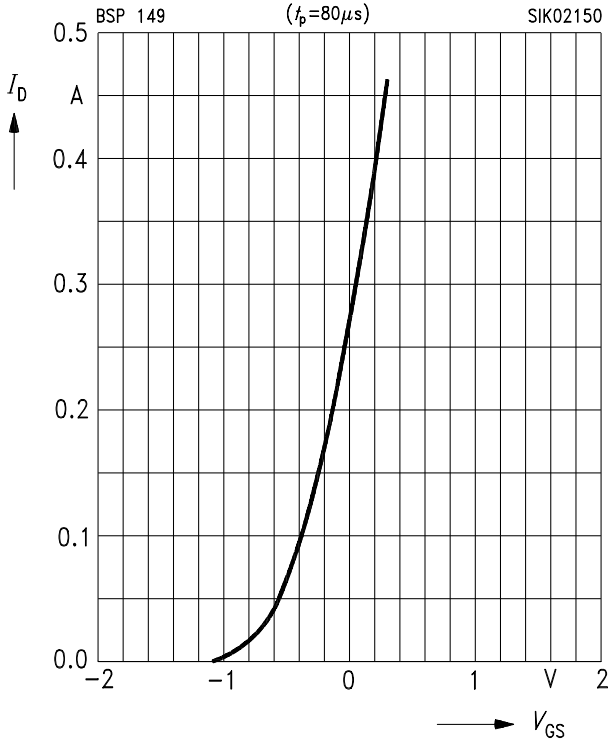

**Typ. forward transconductance**  $g_{fs} = f(I_D)$   
 parameter:  $V_{DS} \geq 2 \times I_D \times R_{DS(on)max.}$ ,  $t_p = 80 \mu s$

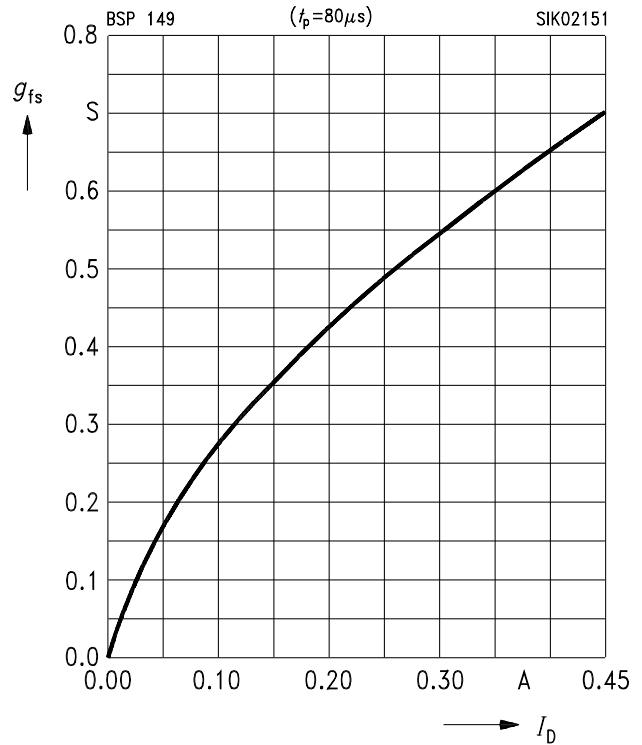

**Drain-source on-resistance**

$R_{DS(on)} = f(T_j)$   
 parameter:  $I_D = 0.03 A$ ,  $V_{GS} = 0 V$ , (spread)

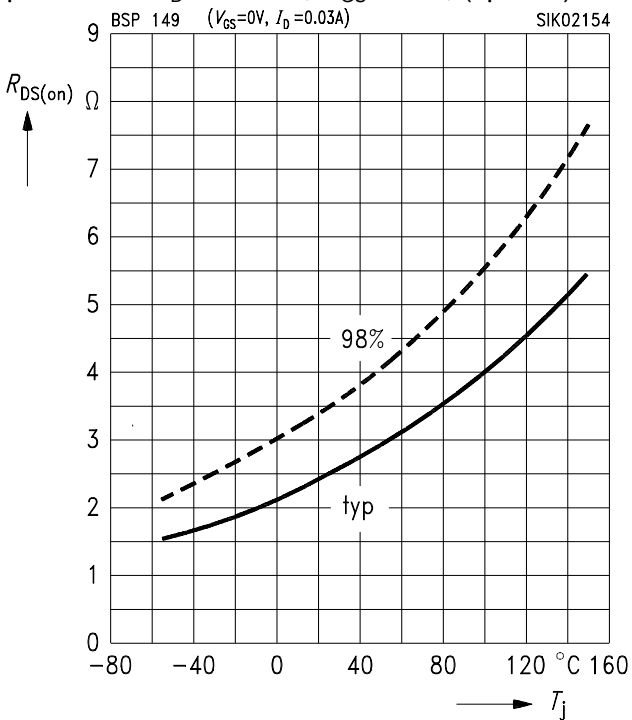

**Typ. capacitances**  $C = f(V_{DS})$

parameter:  $V_{GS} = 0$ ,  $f = 1 MHz$

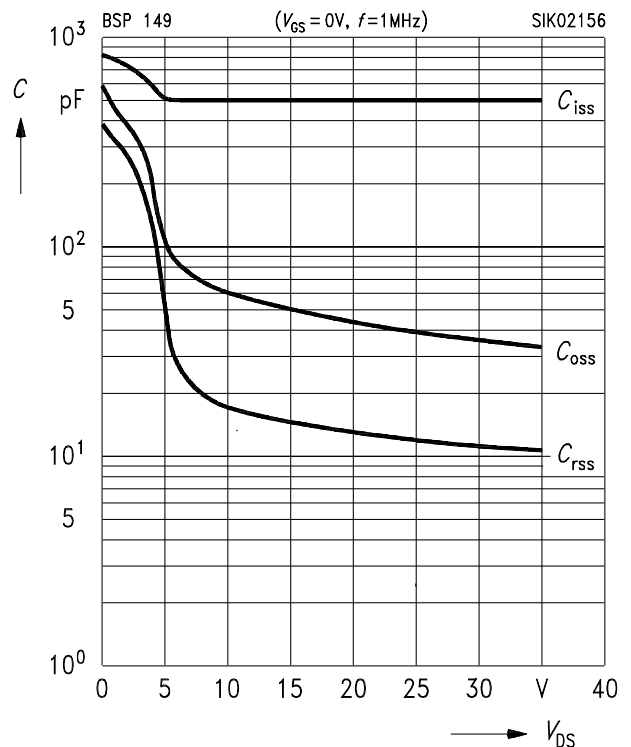

**Gate threshold voltage**  $V_{GS(th)} = f(T_j)$   
 parameter:  $V_{DS} = 3\text{ V}$ ,  $I_D = 1\text{ mA}$ , (spread)

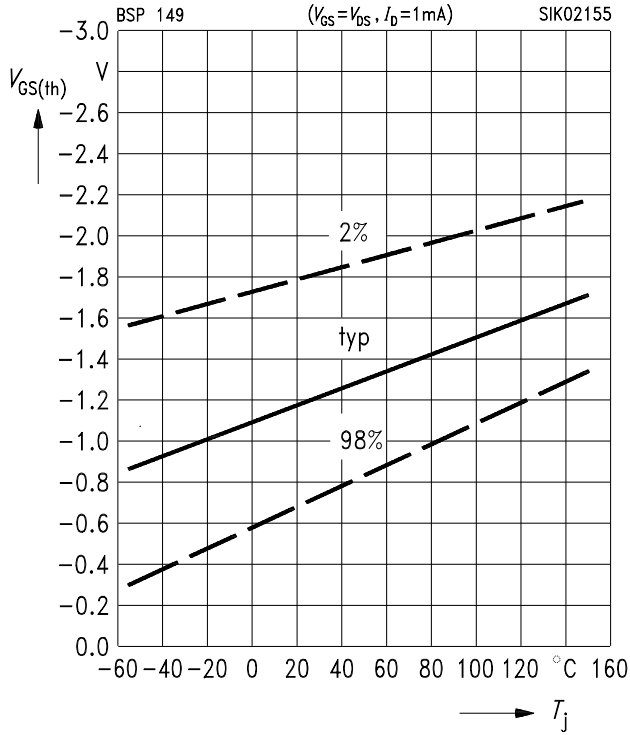

**Forward characteristics of reverse diode**  
 $I_F = f(V_{SD})$   
 parameter:  $t_p = 80\ \mu\text{s}$ ,  $T_j$ , (spread)

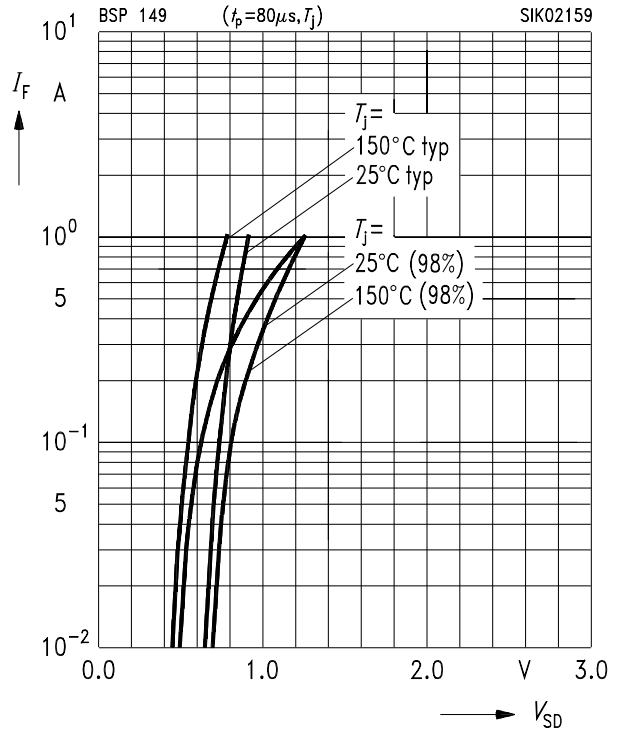

**Drain current**  $I_D = f(T_A)$   
 parameter:  $V_{GS} \geq 3\text{ V}$

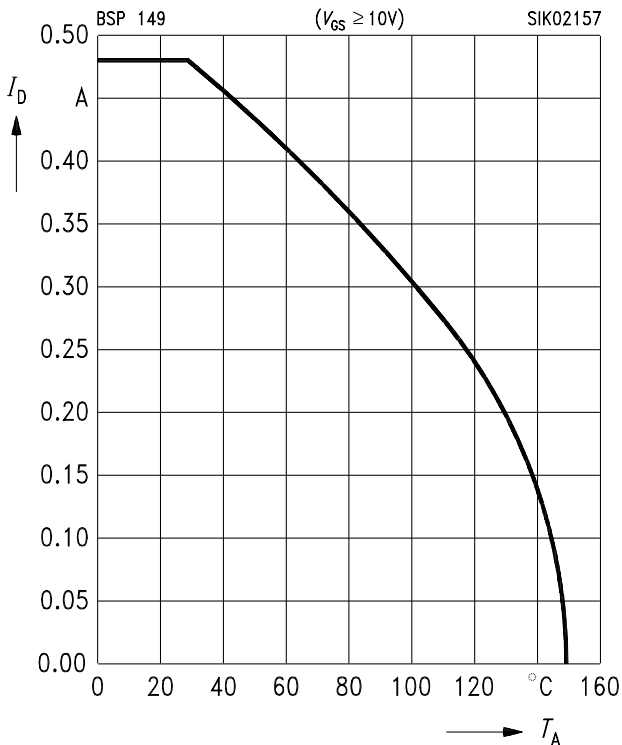

**Safe operating area**  $I_D = f(V_{DS})$   
 parameter:  $D = 0$ ,  $T_c = 25\text{ °C}$

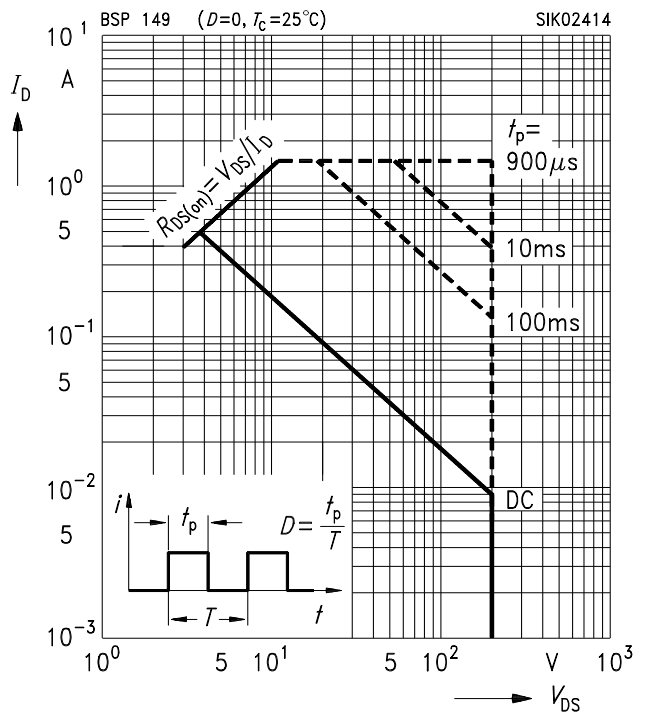

Drain-source breakdown voltage

$$V_{(BR)DSS} = b \times V_{(BR)DSS} (25\text{ }^{\circ}\text{C})$$

