



Micro Commercial Components
 21201 Itasca Street Chatsworth
 CA 91311
 Phone: (818) 701-4933
 Fax: (818) 701-4939

DLSF11 THRU DLSF18

Features

- High Surge Capability
- Low Leakage
- Low Forward Voltage Drop
- High Current Capability
- Super Fast Switching Speed For High Efficiency

1 Amp Glass Passivated Super Fast Recovery Rectifier 50 to 600 Volts

Maximum Ratings

- Operating Temperature: -55°C to +125°C
- Storage Temperature: -55°C to +150°C

MST Catalog Number	Device Marking	Maximum Recurrent Peak Reverse Voltage	Maximum RMS Voltage	Maximum DC Blocking Voltage
DLSF11	---	50V	35V	50V
DLSF12	---	100V	70V	100V
DLSF13	---	150V	105V	150V
DLSF14	---	200V	140V	200V
DLSF15	---	300V	210V	300V
DLSF16	---	400V	280V	400V
DLSF18	---	600V	420V	600V

MELF

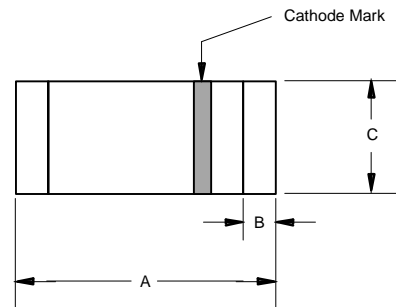

DIMENSIONS

DIM	INCHES		MM		NOTE
	MIN	MAX	MIN	MAX	
A	.190	.205	4.80	5.20	
B	---	.022	---	.55	Nominal
C	.095	.099	2.40	2.50	∅

Electrical Characteristics @ 25°C Unless Otherwise Specified

Average Forward Current	$I_{F(AV)}$	1 A	$T_A = 55^\circ\text{C}$
Peak Forward Surge Current	I_{FSM}	30A	8.3ms, half sine
Maximum Instantaneous Forward Voltage DLSF11-DLSF15 DLSF16-DLSF18	V_F	.975V 1.25V	$I_{FM} = 1.0A$; $T_A = 25^\circ\text{C}$
Maximum DC Reverse Current At Rated DC Blocking Voltage	I_R	5 μ A 50 μ A	$T_A = 25^\circ\text{C}$ $T_A = 150^\circ\text{C}$
Maximum Reverse Recovery Time ¹⁶⁻¹⁸	T_{rr}	35ns 50ns	$I_F=0.5A, I_R=1.0A,$ $I_{rr}=0.25A$
Typical Junction Capacitance DLSF11-DLSF15 DLSF16-DLSF18	C_J	15pF 10pF	Measured at 1.0MHz, $V_R=4.0V$

SUGGESTED SOLDER PAD LAYOUT

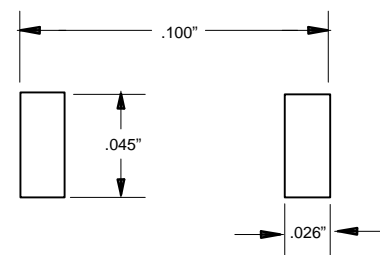

*Pulse Test: Pulse Width 300 μ sec, Duty Cycle 1%

Figure 1
Typical Forward Characteristics

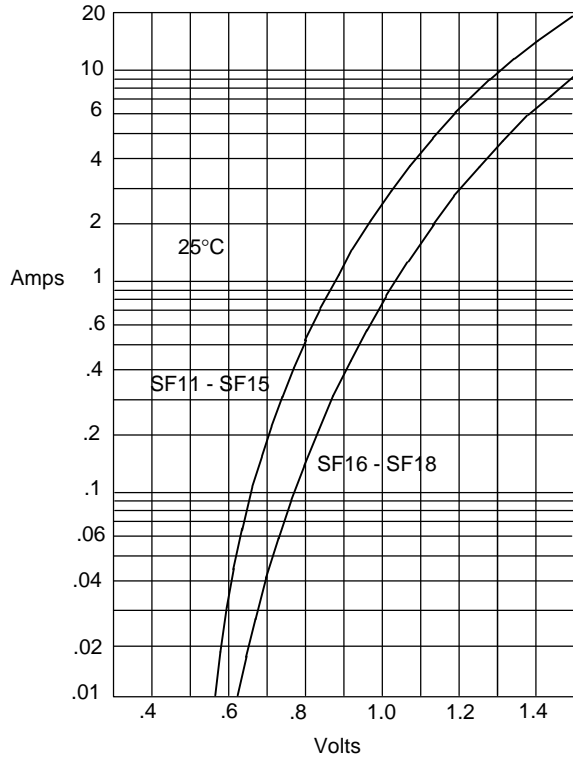

Instantaneous Forward Current - Amperes *versus*
Instantaneous Forward Voltage - Volts

Figure 2
Forward Derating Curve

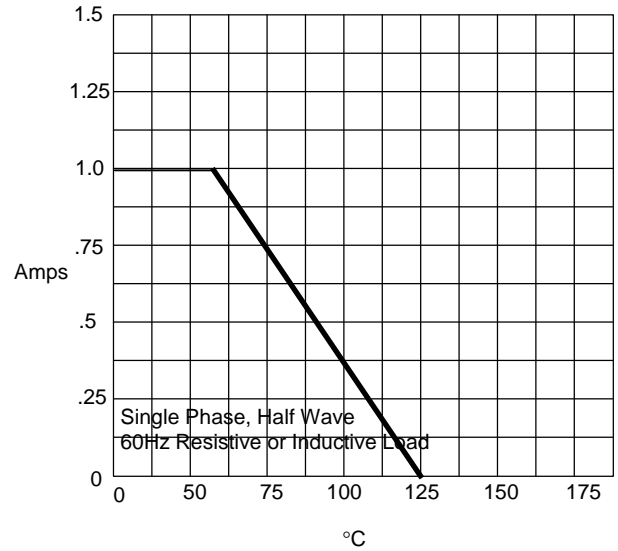

Average Forward Rectified Current - Amperes *versus*
Ambient Temperature - °C

Figure 3
Junction Capacitance

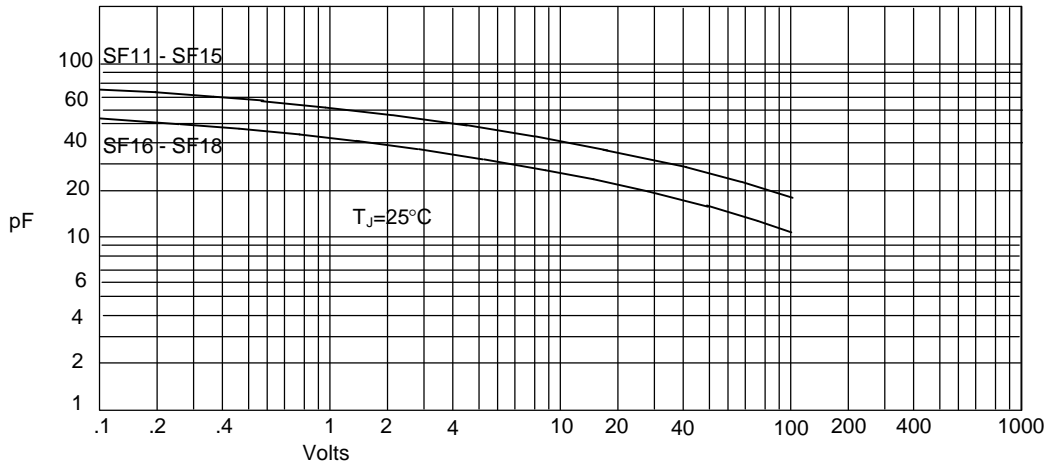

Junction Capacitance - pF *versus*
Reverse Voltage - Volts

DLSF11 thru DLSF18

Figure 4
Typical Reverse Characteristics

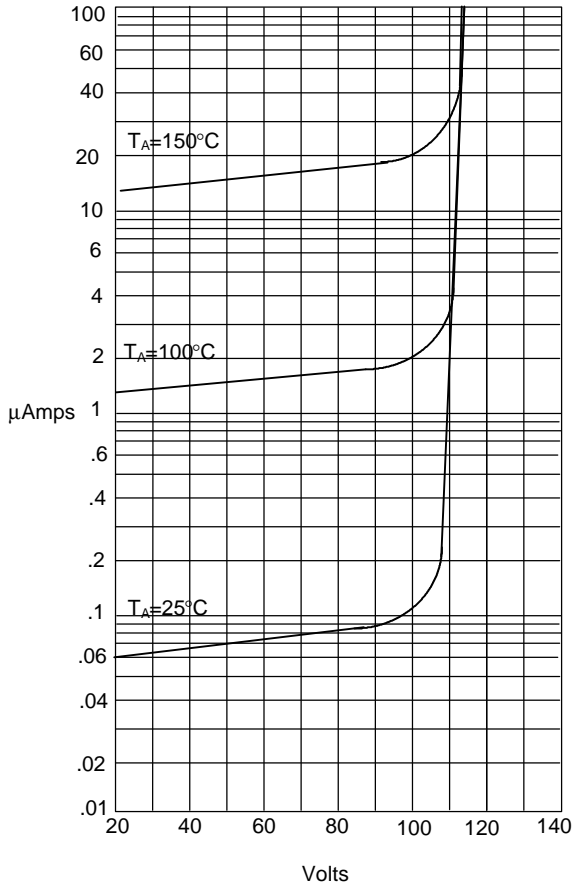

Instantaneous Reverse Leakage Current - MicroAmperes versus
Percent Of Rated Peak Reverse Voltage - Volts

Figure 5
Peak Forward Surge Current

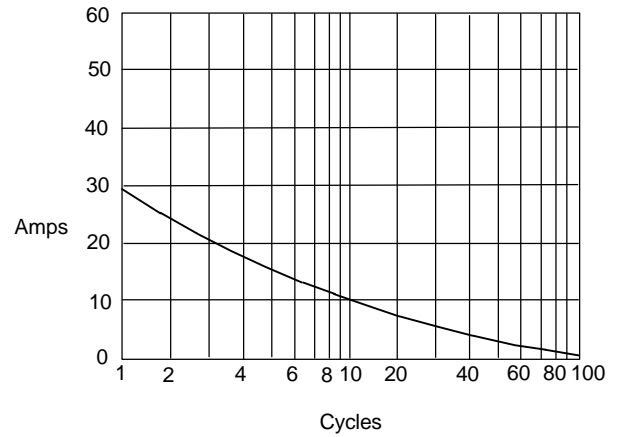

Peak Forward Surge Current - Amperes versus
Number Of Cycles At 60Hz - Cycles

Figure 6
Reverse Recovery Time Characteristic And Test Circuit Diagram

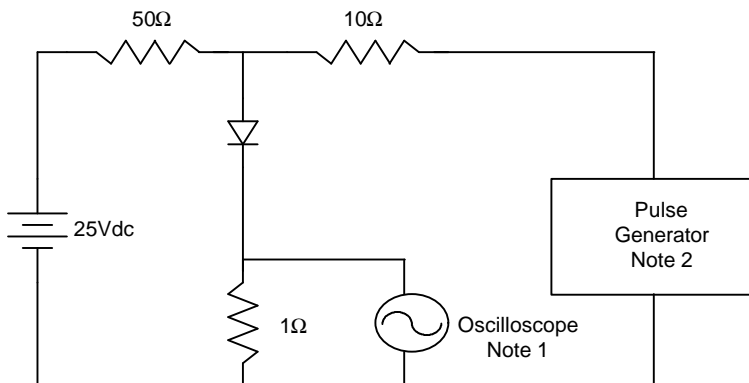

- Notes:
1. Rise Time = 7ns max.
Input impedance = 1 megohm, 22pF
 2. Rise Time = 10ns max.
Source impedance = 50 ohms
 3. Resistors are non-inductive

