

MAXIM

500mA Low-Dropout Linear Regulator in μ MAX

MAX1792

General Description

The MAX1792 low-dropout linear regulator operates from a +2.5V to +5.5V supply and delivers a guaranteed 500mA load current with low 130mV dropout. The high-accuracy ($\pm 1\%$) output voltage is preset at an internally trimmed voltage (see *Selector Guide*) or can be adjusted from 1.25V to 5.0V with an external resistive divider.

An internal PMOS pass transistor allows the low 80 μ A supply current to remain independent of load, making this device ideal for portable battery-operated equipment such as personal digital assistants (PDAs), cellular phones, cordless phones, base stations, and notebook computers.

Other features include an active-low open-drain reset output with a 4ms timeout period that indicates when the output is out of regulation, a 0.1 μ A shutdown mode, short-circuit protection, and thermal shutdown protection. The device is available in a miniature 1.3W, 8-pin power- μ MAX package with a metal pad on the underside of the package.

Applications

Notebook Computers
Cellular and Cordless Telephones
Personal Digital Assistants (PDAs)
Palmtop Computers
Base Stations
USB Hubs
Docking Stations

Features

- ◆ Guaranteed 500mA Output Current
- ◆ Low 130mV Dropout at 500mA
- ◆ Up to $\pm 1\%$ Output Voltage Accuracy
 - Presets at 1.5V, 1.8V, 2.5V, 3.3V, or 5.0V
 - Adjustable from 1.25V to 5.0V
- ◆ Reset Output with 4ms Timeout Period
- ◆ Low 80 μ A Ground Current
- ◆ 0.1 μ A Shutdown Current
- ◆ Thermal Overload Protection
- ◆ Output Current Limit
- ◆ Tiny 1.3W Power- μ MAX Package

Ordering Information

PART*	TEMP RANGE	PIN-PACKAGE
MAX1792EUA_ _	-40°C to +85°C	8 Power- μ MAX

*Insert the desired two-digit suffix (see *Selector Guide*) into the blanks to complete the part number.

Contact factory for other preset output voltages.

Selector Guide

PART AND SUFFIX	V _{OUT}	μ MAX TOP MARK
MAX1792EUA15	1.5V or Adj.	AAAE
MAX1792EUA18	1.8V or Adj.	AAAA
MAX1792EUA25	2.5V or Adj.	AAAB
MAX1792EUA33	3.3V or Adj.	AAAC
MAX1792EUA50	5.0V or Adj.	AAAD

Typical Operating Circuit

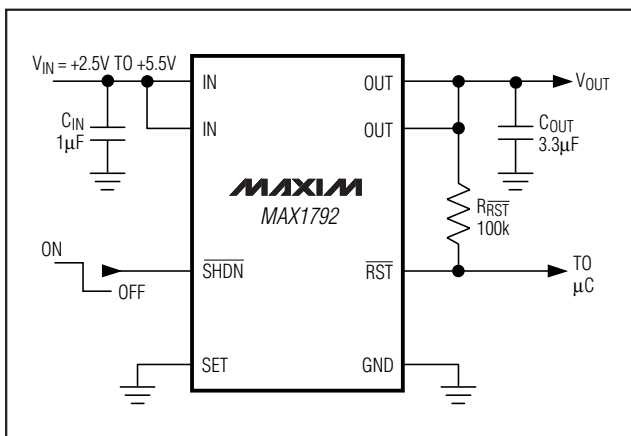

Pin Configuration

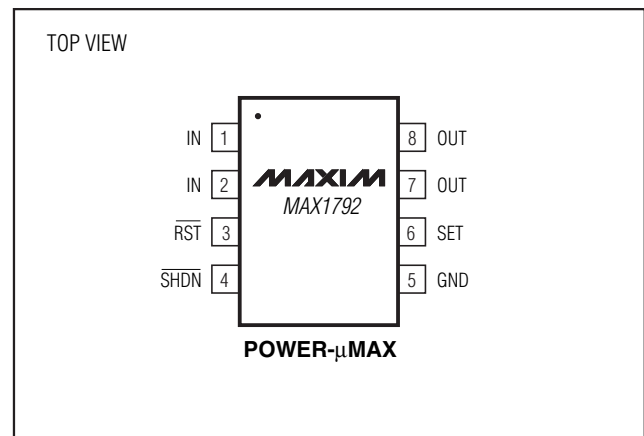

MAXIM

Maxim Integrated Products 1

For price, delivery, and to place orders, please contact Maxim Distribution at 1-888-629-4642, or visit Maxim's website at www.maxim-ic.com.

500mA Low-Dropout Linear Regulator in μ MAX

ABSOLUTE MAXIMUM RATINGS

IN, $\overline{\text{SHDN}}$, $\overline{\text{RST}}$, SET to GND -0.3V to +6V
 OUT to GND -0.3V to ($V_{\text{IN}} + 0.3\text{V}$)
 Output Short-Circuit Duration Indefinite
 Continuous Power Dissipation ($T_{\text{A}} = +70^{\circ}\text{C}$)
 8-Pin Power- μ MAX (derate 17mW/ $^{\circ}\text{C}$ above $+70^{\circ}\text{C}$) 1.3W

Operating Temperature Range -40°C to $+85^{\circ}\text{C}$
 Junction Temperature $+150^{\circ}\text{C}$
 Storage Temperature Range -65°C to $+150^{\circ}\text{C}$
 Lead Temperature (soldering, 10s) $+300^{\circ}\text{C}$

Stresses beyond those listed under "Absolute Maximum Ratings" may cause permanent damage to the device. These are stress ratings only, and functional operation of the device at these or any other conditions beyond those indicated in the operational sections of the specifications is not implied. Exposure to absolute maximum rating conditions for extended periods may affect device reliability.

ELECTRICAL CHARACTERISTICS

($V_{\text{IN}} = V_{\text{OUT(NOM)}} + 500\text{mV}$, or $V_{\text{IN}} = +2.5\text{V}$ (whichever is greater), $\overline{\text{SHDN}} = \text{IN}$, $T_{\text{A}} = 0^{\circ}\text{C}$ to $+85^{\circ}\text{C}$, unless otherwise noted. Typical values are at $T_{\text{A}} = +25^{\circ}\text{C}$.)

PARAMETER	SYMBOL	CONDITIONS	MIN	TYP	MAX	UNITS	
Input Voltage	V_{IN}		2.5		5.5	V	
Input Undervoltage Lockout	V_{UVLO}	Rising, 75mV hysteresis	2.0	2.15	2.3	V	
Output Voltage Accuracy (Preset Mode)	V_{OUT}	$I_{\text{OUT}} = 100\text{mA}$, $T_{\text{A}} = +85^{\circ}\text{C}$				%	
		Preset $V_{\text{OUT}} \geq 2.5\text{V}$	-1		+1		
		Preset $V_{\text{OUT}} < 2.5\text{V}$	-1.5		+1.5	%	
		$I_{\text{OUT}} = 100\text{mA}$, $T_{\text{A}} = 0^{\circ}\text{C}$ to $+85^{\circ}\text{C}$	-2		+2		
		$I_{\text{OUT}} = 1\text{mA}$ to 500mA , $V_{\text{IN}} > V_{\text{OUT}} + 0.5\text{V}$, $T_{\text{A}} = 0^{\circ}\text{C}$ to $+85^{\circ}\text{C}$	-3		+3		
Adjustable Output Voltage Range			1.25		5	V	
SET Voltage Threshold (Adjustable Mode)	V_{SET}	$V_{\text{IN}} = +2.7\text{V}$, V_{OUT} set to 2.0V, $I_{\text{OUT}} = 100\text{mA}$				V	
		$T_{\text{A}} = +85^{\circ}\text{C}$	1.229	1.250	1.271		
		$T_{\text{A}} = 0^{\circ}\text{C}$ to $+85^{\circ}\text{C}$	1.219		1.281		
Maximum Output Current	I_{OUT}	$V_{\text{IN}} \geq 2.7\text{V}$	500			mARMS	
Short-Circuit Current Limit	I_{LIM}	$V_{\text{OUT}} = 0$, $V_{\text{IN}} \geq 2.7\text{V}$	0.55	0.8	1.8	A	
In-Regulation Current Limit		$V_{\text{OUT}} > 96\%$ of nominal value, $V_{\text{IN}} \geq 2.7\text{V}$		1.6		A	
SET Dual Mode™ Threshold			50	100	150	mV	
SET Input Bias Current	I_{SET}	$V_{\text{SET}} = 1.25\text{V}$	-100		+100	nA	
Ground-Pin Current	I_{Q}	$I_{\text{OUT}} = 1\text{mA}$		80	250	μA	
		$I_{\text{OUT}} = 500\text{mA}$		110			
Dropout Voltage (Note 1)	$V_{\text{IN}} - V_{\text{OUT}}$	$I_{\text{OUT}} = 500\text{mA}$	$V_{\text{OUT}} = 5.0\text{V}$		120	225	mV
			$V_{\text{OUT}} = 3.3\text{V}$		130	250	
			$V_{\text{OUT}} = 2.5\text{V}$		210	360	
Line Regulation	ΔV_{LNR}	V_{IN} from ($V_{\text{OUT}} + 100\text{mV}$) to 5.5V, $I_{\text{LOAD}} = 5\text{mA}$	-0.15	0	+0.15	%/V	
Load Regulation	ΔV_{LDR}	$I_{\text{OUT}} = 1\text{mA}$ to 500mA		0.4	1.0	%	
Output Voltage Noise		10Hz to 1MHz, $C_{\text{OUT}} = 3.3\mu\text{F}$ (ESR $< 0.1\Omega$)		115		μVRMS	
SHUTDOWN							
Shutdown Supply Current	I_{OFF}	$\overline{\text{SHDN}} = \text{GND}$, $V_{\text{IN}} = 5.5\text{V}$		0.1	15	μA	
$\overline{\text{SHDN}}$ Input Threshold	V_{IH}	$2.5\text{V} < V_{\text{IN}} < 5.5\text{V}$	1.6			V	
	V_{IL}	$2.5\text{V} < V_{\text{IN}} < 5.5\text{V}$			0.6		
$\overline{\text{SHDN}}$ Input Bias Current		$\overline{\text{SHDN}} = \text{IN}$ or GND		10	100	nA	

Dual Mode is a trademark of Maxim Integrated Products.

500mA Low-Dropout Linear Regulator in μ MAX

MAX1792

ELECTRICAL CHARACTERISTICS (continued)

($V_{IN} = V_{OUT(NOM)} + 500mV$, or $V_{IN} = +2.5V$ (whichever is greater), $\overline{SHDN} = IN$, $T_A = 0^{\circ}C$ to $+85^{\circ}C$, unless otherwise noted. Typical values are at $T_A = +25^{\circ}C$.)

PARAMETER	SYMBOL	CONDITIONS	MIN	TYP	MAX	UNITS
RESET OUTPUT						
Reset Output Low Voltage	V_{OL}	\overline{RST} sinking 1mA		0.01	0.1	V
Operating Voltage Range for Valid Reset		\overline{RST} sinking 100 μ A	1.0		5.5	V
\overline{RST} Output High Leakage Current		$V_{\overline{RST}} = +5.5V$			100	nA
\overline{RST} Threshold		Rising edge, referred to $V_{OUT(NOMINAL)}$	90	93	96	%
\overline{RST} Release Delay	t_{RP}	Rising edge of OUT to rising edge of \overline{RST}	1.5	4.5	8	ms
THERMAL PROTECTION						
Thermal Shutdown Temperature	T_{SHDN}			170		$^{\circ}C$
Thermal Shutdown Hysteresis	ΔT_{SHDN}			20		$^{\circ}C$

ELECTRICAL CHARACTERISTICS

($V_{IN} = V_{OUT(NOM)} + 500mV$, or $V_{IN} = +2.5V$ (whichever is greater), $\overline{SHDN} = IN$, $T_A = -40^{\circ}C$ to $+85^{\circ}C$, unless otherwise noted.) (Note 2)

PARAMETER	SYMBOL	CONDITIONS	MIN	MAX	UNITS	
Input Voltage	V_{IN}		2.5	5.5	V	
Input Undervoltage Lockout	V_{UVLO}	Rising or falling	2.0	2.3	V	
Output Voltage Accuracy (Preset Mode)	V_{OUT}	$I_{OUT} = 100mA$	-2	+2	%	
		$I_{OUT} = 1mA$ to 500mA	-3	+3		
Adjustable Output Voltage Range			1.25	5	V	
SET Voltage Threshold (Adjustable Mode)	V_{SET}	$I_{OUT} = 100mA$	1.212	1.288	V	
Maximum Output Current	I_{OUT}		500		mARMS	
Short-Circuit Current Limit	I_{LIM}	$V_{OUT} = 0$	0.55	1.8	A	
SET Dual Mode Threshold			50	150	mV	
SET Input Bias Current	I_{SET}	$V_{SET} = 1.25V$	-100	+100	nA	
Ground-Pin Current	I_Q	$I_{OUT} = 1mA$		250	μ A	
Dropout Voltage (Note 1)	$V_{IN} - V_{OUT}$	$I_{OUT} = 500mA$	$V_{OUT} = 5.0V$		225	mV
			$V_{OUT} = 3.3V$		250	
			$V_{OUT} = 2.5V$		360	
Line Regulation	ΔV_{LNR}	V_{IN} from $(V_{OUT} + 100mV)$ to 5.5V, $I_{LOAD} = 5mA$	-0.15	+0.15	%/V	
Load Regulation	ΔV_{LDR}	$I_{OUT} = 1mA$ to 500mA		1.0	%	
SHUTDOWN						
Shutdown Supply Current	I_{OFF}	$\overline{SHDN} = GND$, $V_{IN} = +5.5V$		15	μ A	
SHDN Input Threshold	V_{IH}	$2.5V < V_{IN} < 5.5V$	1.6		V	
	V_{IL}	$2.5V < V_{IN} < 5.5V$		0.6		
\overline{SHDN} Input Bias Current	$I_{\overline{SHDN}}$	$\overline{SHDN} = IN$ or GND		100	nA	

500mA Low-Dropout Linear Regulator in μ MAX

ELECTRICAL CHARACTERISTICS (continued)

($V_{IN} = V_{OUT(NOM)} + 500mV$, or $V_{IN} = +2.5V$ (whichever is greater), $\overline{SHDN} = IN$, $T_A = -40^{\circ}C$ to $+85^{\circ}C$, unless otherwise noted.) (Note 2)

PARAMETER	SYMBOL	CONDITIONS	MIN	MAX	UNITS
RESET OUTPUT					
Reset Output Low Voltage	V_{OL}	\overline{RST} sinking 1mA		0.1	V
Operating Voltage Range for Valid Reset		\overline{RST} sinking 100 μ A	1.0	5.5	V
\overline{RST} Output High Leakage Current		$V_{\overline{RST}} = +5.5V$		100	nA
\overline{RST} Threshold		Rising edge, referred to $V_{OUT(NOMINAL)}$	90	96	%
\overline{RST} Release Delay	t_{RP}	Rising edge of OUT to rising edge of \overline{RST}	1.5	8	ms

Note 1: Dropout voltage is defined as $V_{IN} - V_{OUT}$, when V_{OUT} is 100mV below the value of V_{OUT} measured when $V_{IN} = V_{OUT(NOM)} + 0.5V$. Since the minimum input voltage is 2.5V, this specification is only meaningful when $V_{OUT(NOM)} \geq 2.5V$. For $V_{OUT(NOM)}$ between 2.5V and 3.5V, use the following equations: Typical Dropout = $-93mV/V \times V_{OUT(NOM)} + 445mV$; Guaranteed Maximum Dropout = $-137mV/V \times V_{OUT(NOM)} + 704mV$. For $V_{OUT(NOM)} \geq 3.5V$: Typical Dropout = 120mV; Guaranteed Maximum Dropout = 225mV.

Note 2: Specifications to $-40^{\circ}C$ are guaranteed by design, not production tested.

Typical Operating Characteristics

(MAX1792EUA33, $V_{IN} = V_{OUT} + 500mV$, $\overline{SHDN} = IN$, $C_{IN} = 1\mu F$, $C_{OUT} = 3.3\mu F$, $T_A = +25^{\circ}C$, unless otherwise noted.)

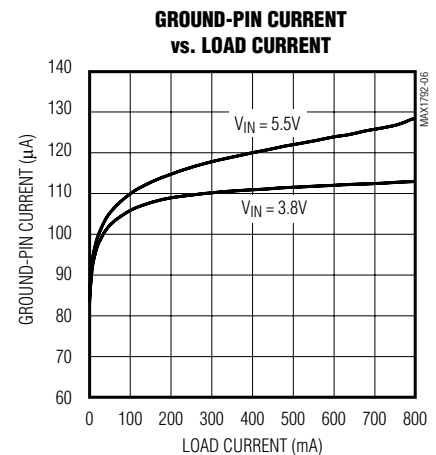
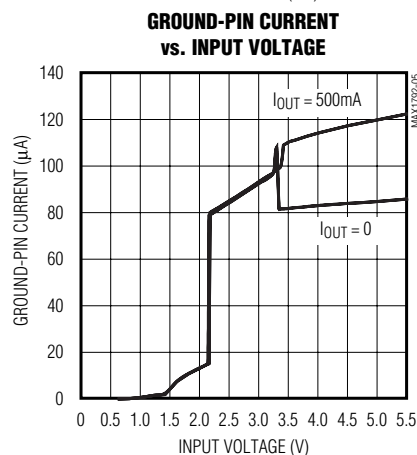
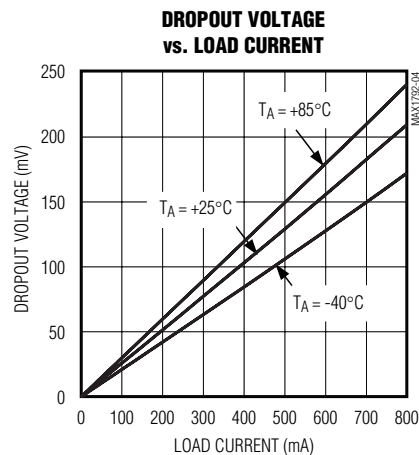
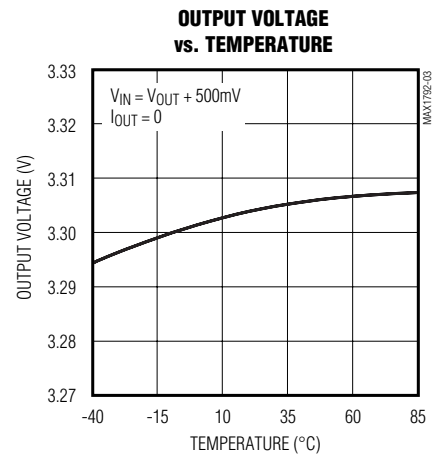
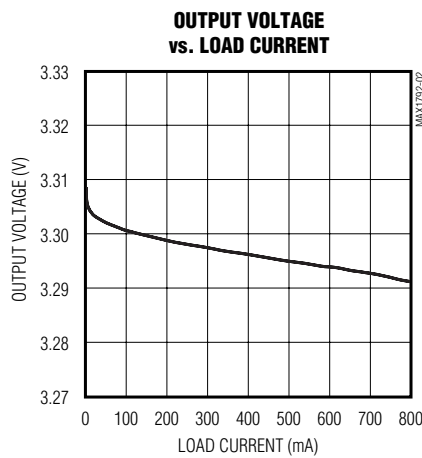
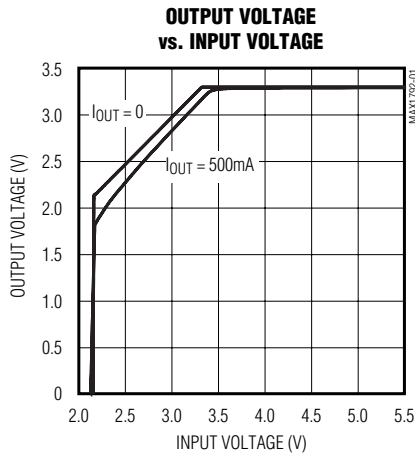

500mA Low-Dropout Linear Regulator in μ MAX

MAX1792

Typical Operating Characteristics (continued)

(MAX1792EUA33, $V_{IN} = V_{OUT} + 500\text{mV}$, $\text{SHDN} = \text{IN}$, $C_{IN} = 1\mu\text{F}$, $C_{OUT} = 3.3\mu\text{F}$, $T_A = +25^\circ\text{C}$, unless otherwise noted.)

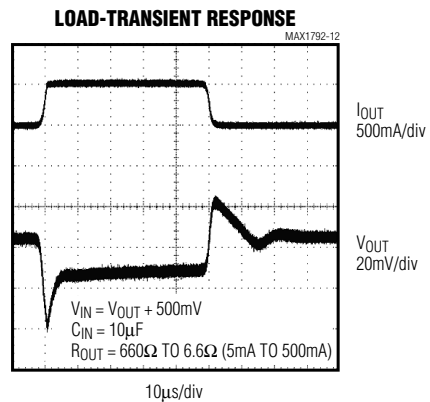
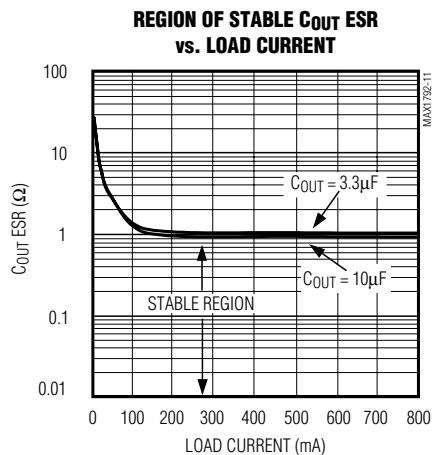
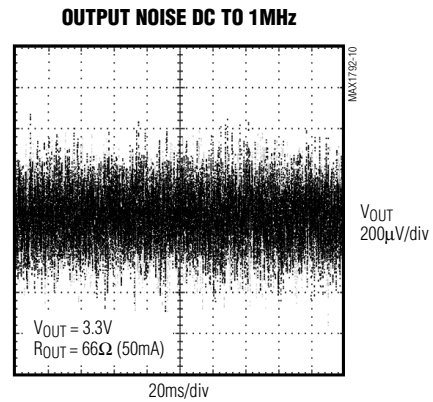
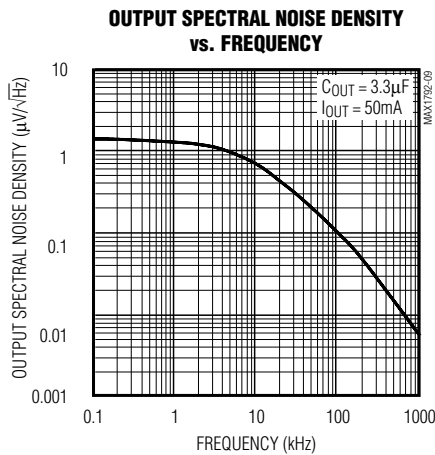
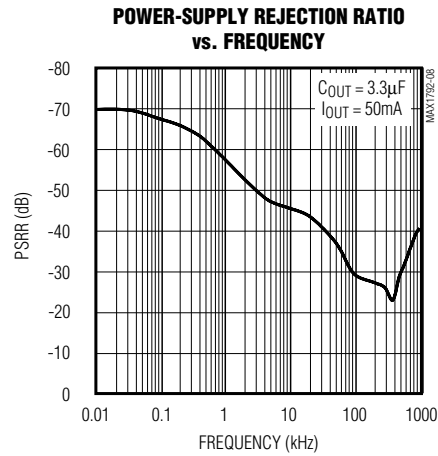
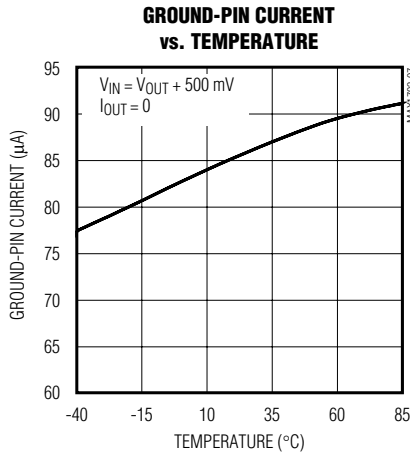

500mA Low-Dropout Linear Regulator in μ MAX

Typical Operating Characteristics (continued)

(MAX1792EUA33, $V_{IN} = V_{OUT} + 500\text{mV}$, $\overline{\text{SHDN}} = \text{IN}$, $C_{IN} = 1\mu\text{F}$, $C_{OUT} = 3.3\mu\text{F}$, $T_A = +25^\circ\text{C}$, unless otherwise noted.)

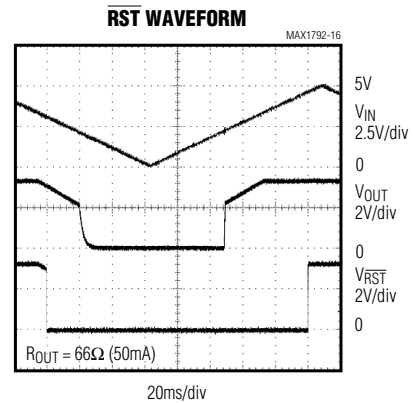
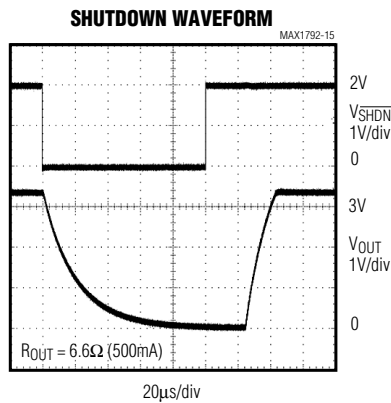
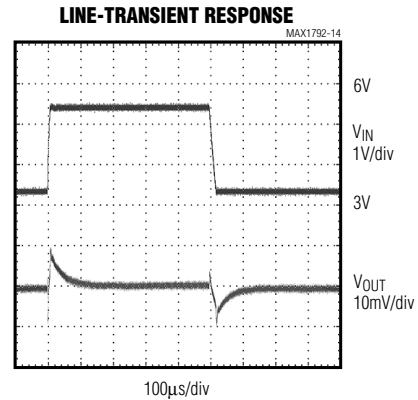
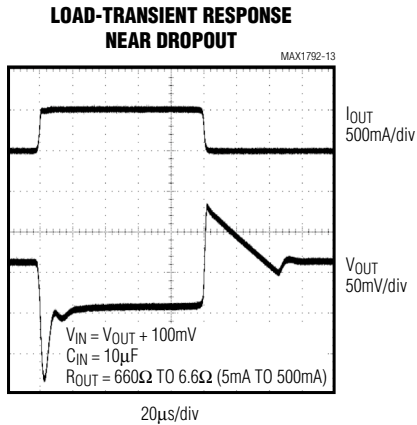

Pin Description

PIN	NAME	FUNCTION
1, 2	IN	Regulator Input. Supply voltage can range from +2.5V to +5.5V. Bypass with a 1 μF capacitor to GND (see <i>Capacitor Selection and Regulator Stability</i>). Connect both input pins together externally.
3	$\overline{\text{RST}}$	Open-Drain Active-Low Reset Output. $\overline{\text{RST}}$ remains low while the output voltage (V_{OUT}) is below the reset threshold and for at least 4ms after V_{OUT} rises above the reset threshold. Connect a 100k Ω pullup resistor to OUT to obtain an output voltage.
4	$\overline{\text{SHDN}}$	Active-Low Shutdown Input. A logic low reduces supply current to 0.1 μA . In shutdown, the $\overline{\text{RST}}$ output is low and OUT is pulled low through an internal 5k Ω resistor. Connect to IN for normal operation.
5	GND	Ground. This pin and the exposed pad also function as a heatsink. Solder both to a large pad or to the circuit-board ground plane to maximize power dissipation.
6	SET	Voltage-Setting Input. Connect to GND for preset output. Connect to a resistive divider between OUT and GND to set the output voltage between 1.25V and 5.0V.
7, 8	OUT	Regulator Output. Sources up to 500mA. Bypass with a 3.3 μF low-ESR capacitor to GND. Use a 4.7 μF capacitor for output voltages below 2V. Connect both output pins together externally.

500mA Low-Dropout Linear Regulator in μ MAX

MAX1792

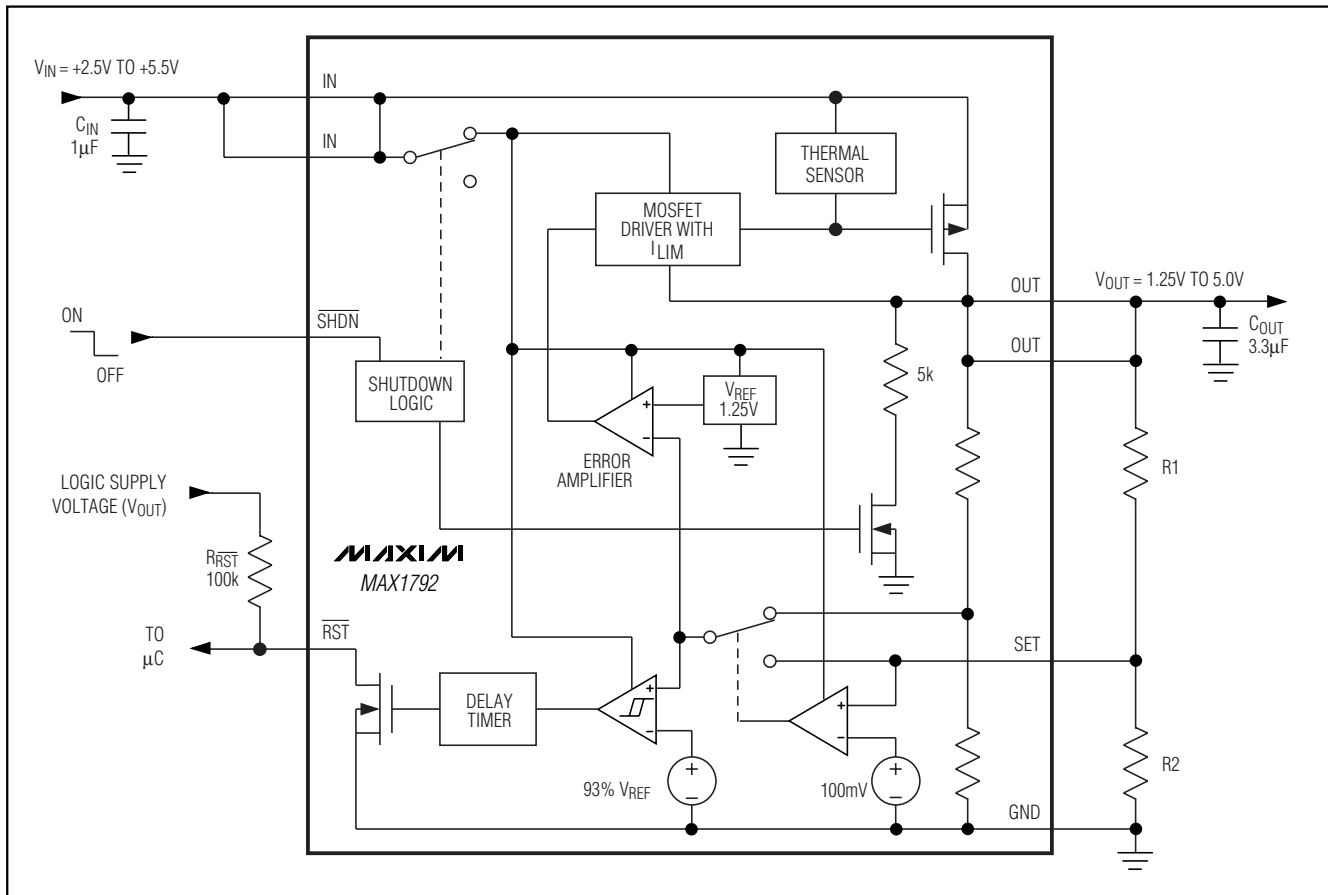

Figure 1. Functional Diagram

Detailed Description

The MAX1792 is a low-dropout, low-quiescent-current linear regulator designed primarily for battery-powered applications. The device supplies loads up to 500mA and is available with preset output voltages. As illustrated in Figure 1, the MAX1792 consists of a 1.25V reference, error amplifier, P-channel pass transistor, and internal feedback voltage-divider.

The 1.25V reference is connected to the error amplifier, which compares this reference with the feedback voltage and amplifies the difference. If the feedback voltage is lower than the reference voltage, the pass-transistor gate is pulled lower, which allows more current to pass to the output and increases the output voltage. If the feedback voltage is too high, the pass-transistor gate is pulled up, allowing less current to pass to the output.

The output voltage is fed back through either an internal resistive divider connected to OUT or an external resistor network connected to SET. The Dual Mode comparator examines V_{SET} and selects the feedback path. If V_{SET} is below 50mV, the internal feedback path is used and the output is regulated to the factory-preset voltage.

Additional blocks include an output current limiter, thermal sensor, and shutdown logic.

Internal P-Channel Pass Transistor

The MAX1792 features a 0.25 Ω P-channel MOSFET pass transistor. Unlike similar designs using PNP pass transistors, P-channel MOSFETs require no base drive, which reduces quiescent current. PNP-based regulators also waste considerable current in dropout when the pass transistor saturates, and use high base-drive currents under large loads.

500mA Low-Dropout Linear Regulator in μ MAX

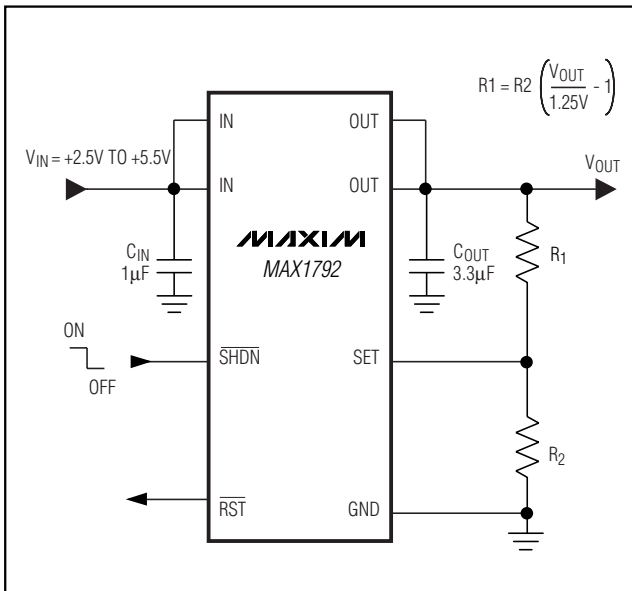

Figure 2. Adjustable Output Using External Feedback Resistors

The MAX1792 does not suffer from these problems and consumes only 110 μ A of quiescent current under heavy loads as well as in dropout.

Output Voltage Selection

The MAX1792's Dual Mode operation allows operation in either a preset voltage mode or an adjustable mode. Connect SET to GND to select the preset output voltage. The two-digit part number suffix identifies the output voltage (see *Selector Guide*). For example, the MAX1792EUA33 has a preset 3.3V output voltage.

The output voltage may also be adjusted by connecting a voltage-divider from OUT to SET (Figure 2). Select R2 in the 25k Ω to 100k Ω range. Calculate R1 with the following equation:

$$R1 = R2 [(V_{OUT} / V_{SET}) - 1]$$

where $V_{SET} = 1.25V$ and V_{OUT} may range from 1.25V to 5.0V.

Shutdown

Pull \overline{SHDN} low to enter shutdown. During shutdown, the output is disconnected from the input and supply current drops to 0.1 μ A. When in shutdown, \overline{RST} pulls low and OUT is discharged through an internal 5k Ω resistor. The capacitance and load at OUT determine the rate at which V_{OUT} decays. SHDN can be pulled as high as +6V, regardless of the input and output voltage.

Reset Output

The reset output (\overline{RST}) pulls low when OUT is less than 93% of the nominal regulation voltage. Once OUT exceeds 93% of the nominal voltage, \overline{RST} goes high impedance after 4ms. \overline{RST} is an open-drain N-channel output. To obtain a voltage output, connect a pullup resistor from \overline{RST} to OUT. A 100k Ω resistor works well for most applications. \overline{RST} can be used as a power-on-reset (POR) signal to a microcontroller (μ C), or drive an external LED to indicate power failure. When the MAX1792 is shut down, \overline{RST} is held low independent of the output voltage. If unused, leave \overline{RST} grounded or unconnected.

Current Limit

The MAX1792 monitors and controls the pass transistor's gate voltage, limiting the output current to 0.8A (typ). This current limit doubles when the output voltage is within 4% of the nominal value to improve performance with large load transients. The output can be shorted to ground for an indefinite period of time without damaging the part.

Thermal Overload Protection

Thermal overload protection limits total power dissipation in the MAX1792. When the junction temperature exceeds $T_J = +170^\circ C$, a thermal sensor turns off the pass transistor, allowing the device to cool. The thermal sensor turns the pass transistor on again after the junction temperature cools by 20 $^\circ C$, resulting in a pulsed output during continuous thermal overload conditions. Thermal overload protection protects the MAX1792 in the event of fault conditions. For continuous operation, do not exceed the absolute maximum junction-temperature rating of $T_J = +150^\circ C$.

Operating Region and Power Dissipation

The MAX1792's maximum power dissipation depends on the thermal resistance of the IC package and circuit board, the temperature difference between the die junction and ambient air, and the rate of air flow. The power dissipated in the device is $P = I_{OUT} \times (V_{IN} - V_{OUT})$. The maximum allowed power dissipation is 1.3W or:

$$P_{MAX} = (T_J(MAX) - T_A) / (\theta_{JC} + \theta_{CA})$$

where $T_J - T_A$ is the temperature difference between the MAX1792 die junction and the surrounding air, θ_{JC} is the thermal resistance from the junction to the case, and θ_{CA} is the thermal resistance from the case through the PC board, copper traces, and other materials to the surrounding air.

The MAX1792 package features an exposed thermal pad on its underside. This pad lowers the thermal resistance of the package by providing a direct heat con-

500mA Low-Dropout Linear Regulator in μ MAX

MAX1792

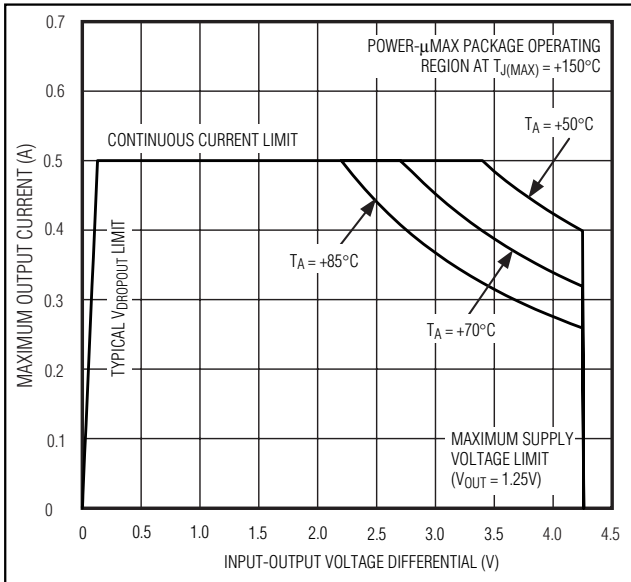

Figure 3. Power Operating Regions: Maximum Output Current vs. Supply Voltage

duction path from the die to the PC board. Additionally, the MAX1792's ground pin (GND) performs the dual function of providing an electrical connection to system ground and channeling heat away. Connect the exposed backside pad and GND to the system ground using a large pad or ground plane, or multiple vias to the ground plane layer.

The MAX1792 delivers up to 0.5A(RMS) and operates with input voltages up to 5.5V, but not simultaneously. High output currents can only be sustained when input-output differential voltages are low, as shown in Figure 3.

Applications Information

Capacitor Selection and Regulator Stability

Capacitors are required at the MAX1792's input and output for stable operation over the full temperature range and with load currents up to 500mA. Connect a 1 μ F capacitor between IN and ground and a 3.3 μ F low equivalent series resistance (ESR) capacitor between OUT and ground. For output voltages less than 2V, use a 4.7 μ F low-ESR output capacitor. The input capacitor (C_{IN}) lowers the source impedance of the input supply. Reduce noise and improve load-transient response, stability, and power-supply rejection by using larger output capacitors such as 10 μ F.

The output capacitor's (C_{OUT}) ESR affects stability and output noise. Use output capacitors with an ESR of 0.1 Ω or less to ensure stability and optimum transient

response. Surface-mount ceramic capacitors have very low ESR and are commonly available in values up to 10 μ F. Connect C_{IN} and C_{OUT} as close to the MAX1792 as possible to minimize the impact of PC board trace inductance.

Noise, PSRR, and Transient Response

The MAX1792 is designed to operate with low dropout voltages and low quiescent currents in battery-powered systems while still maintaining good noise, transient response, and AC rejection. See the *Typical Operating Characteristics* for a plot of Power-Supply Rejection Ratio (PSRR) vs. Frequency. When operating from noisy sources, improved supply-noise rejection and transient response can be achieved by increasing the values of the input and output bypass capacitors and through passive filtering techniques.

The MAX1792 load-transient response graphs (see *Typical Operating Characteristics*) show two components of the output response: a DC shift from the output impedance due to the load current change, and the transient response. A typical transient response for a step change in the load current from 5mA to 500mA is 18mV. Increasing the output capacitor's value and decreasing the ESR attenuates the overshoot.

Input-Output (Dropout) Voltage

A regulator's minimum input-to-output voltage differential (dropout voltage) determines the lowest usable supply voltage. In battery-powered systems, this determines the useful end-of-life battery voltage. Because the MAX1792 uses a P-channel MOSFET pass transistor, its dropout voltage is a function of drain-to-source on-resistance ($R_{\text{DS(ON)}}$) multiplied by the load current (see *Typical Operating Characteristics*):

$$V_{\text{DROPOUT}} = V_{\text{IN}} - V_{\text{OUT}} = R_{\text{DS(ON)}} \times I_{\text{OUT}}$$

The MAX1792 ground current remains below 150 μ A in dropout.

Note: The MAX1792 has an exposed thermal pad on the bottom side of the package.

Chip Information

TRANSISTOR COUNT: 845

500mA Low-Dropout Linear Regulator in μ MAX

Package Information

8LUMAXD EPS

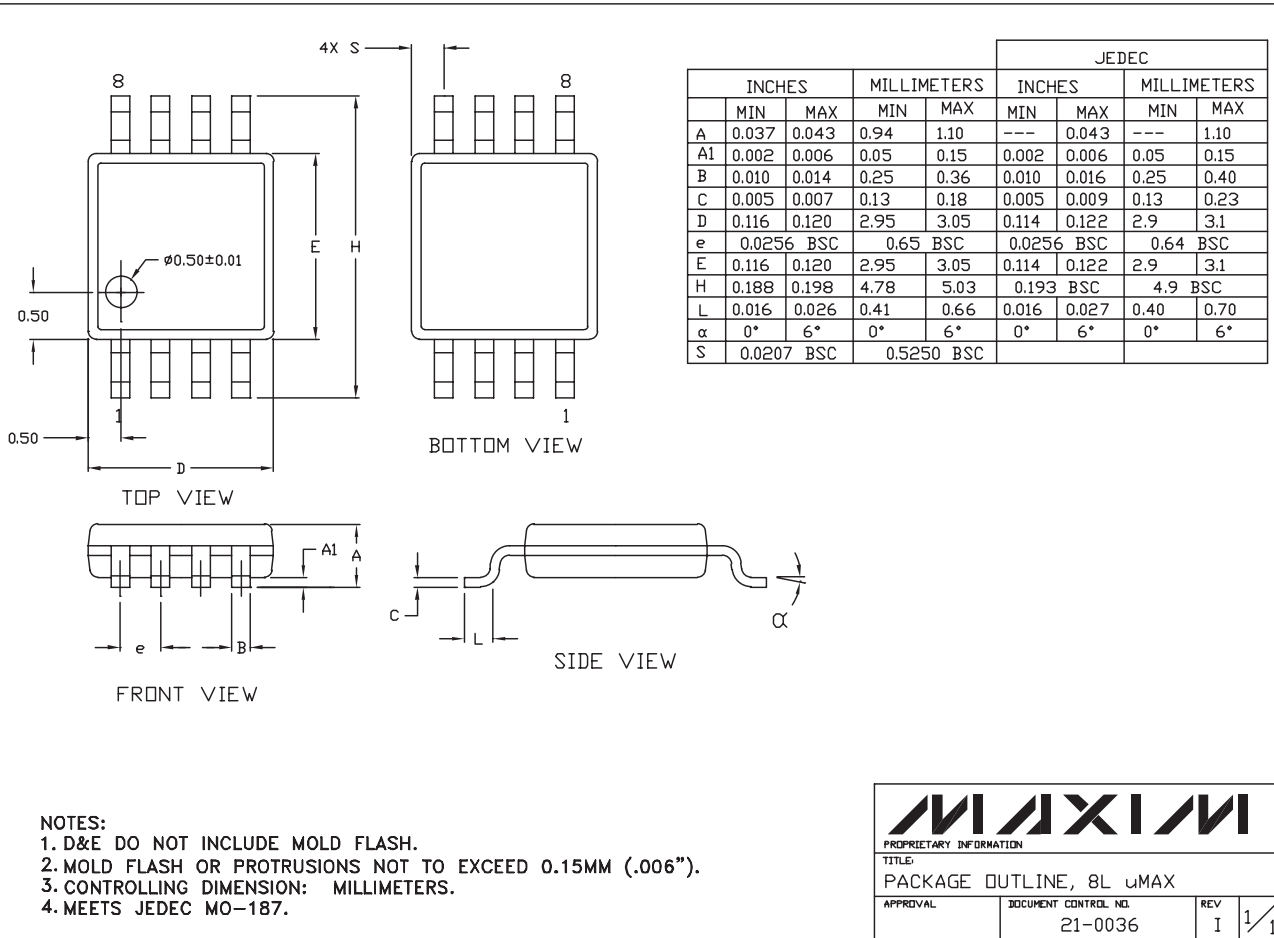

Note: MAX1792 has an exposed thermal pad on the bottom side of the package

Maxim cannot assume responsibility for use of any circuitry other than circuitry entirely embodied in a Maxim product. No circuit patent licenses are implied. Maxim reserves the right to change the circuitry and specifications without notice at any time.

10 **Maxim Integrated Products, 120 San Gabriel Drive, Sunnyvale, CA 94086 408-737-7600**