

LM4860 Boomer® Audio Power Amplifier Series

Series 1W Audio Power Amplifier with Shutdown Mode

General Description

The LM4860 is a bridge-connected audio power amplifier capable of delivering 1W of continuous average power to an 8Ω load with less than 1% (THD+N) over the audio spectrum from a 5V power supply.

Boomer audio power amplifiers were designed specifically to provide high quality output power with a minimal amount of external components using surface mount packaging. Since the LM4860 does not require output coupling capacitors, bootstrap capacitors or snubber networks, it is optimally suited for low-power portable systems.

The LM4860 features an externally controlled, low-power consumption shutdown mode, as well as an internal thermal shutdown protection mechanism. It also includes two headphone control inputs and a headphone sense output for external monitoring.

The unity-gain stable LM4860 can be configured by external gain setting resistors for differential gains of 1 to 10 without the use of external compensation components.

Key Specifications

- THD+N at 1W continuous average

output power into 8Ω: 1% (max)

- Instantaneous peak output power: >2W
- Shutdown current: 0.6 μA (typ)

Features

- No output coupling capacitors, bootstrap capacitors, or snubber circuits are necessary
- Small Outline (SO) power packaging
- Compatible with PC power supplies
- Thermal shutdown protection circuitry
- Unity-gain stable
- External gain configuration capability
- Two headphone control inputs and headphone sensing output

Applications

- Personal computers
- Portable consumer products
- Cellular phones
- Self-powered speakers
- Toys and games

Typical Application

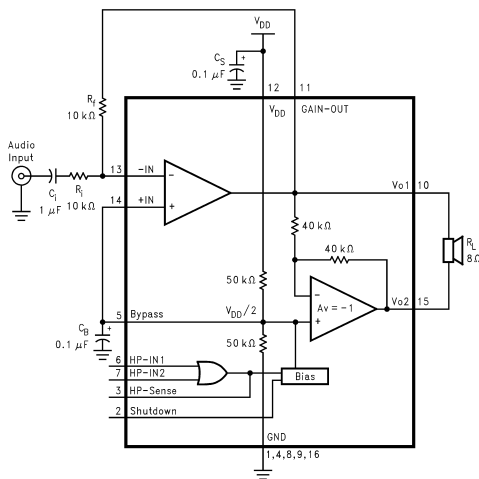
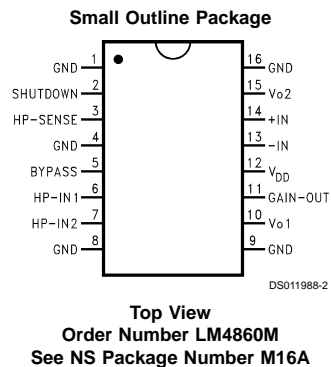

FIGURE 1. Typical Audio Amplifier Application Circuit

Connection Diagram



The Boomer® registered trademark is licensed to National Semiconductor for audio integrated circuits by Rockford Corporation. Patents pending.

Absolute Maximum Ratings (Note 2)

If Military/Aerospace specified devices are required, please contact the National Semiconductor Sales Office/Distributors for availability and specifications.

Supply Voltage	6.0V
Storage Temperature	-65°C to +150°C
Input Voltage	-0.3V to $V_{DD} + 0.3V$
Power Dissipation	Internally limited
ESD Susceptibility (Note 4)	3000V
ESD Susceptibility (Note 5)	250V
Junction Temperature	150°C
Soldering Information	

Small Outline Package

Vapor Phase (60 sec.) 215°C

Infrared (15 sec.) 220°C

See AN-450 "Surface Mounting and their Effects on Product Reliability" for other methods of soldering surface mount devices.

Operating Ratings

Temperature Range

$T_{MIN} \leq T_A \leq T_{MAX}$ -20°C $\leq T_A \leq$ +85°C

Supply Voltage

$2.7V \leq V_{DD} \leq 5.5V$

Electrical Characteristics

(Notes 1, 2) The following specifications apply for $V_{DD} = 5V$, $R_L = 8\Omega$ unless otherwise specified. Limits apply for $T_A = 25^\circ C$.

Symbol	Parameter	Conditions	LM4860		Units (Limits)
			Typical (Note 6)	Limit (Note 7)	
V_{DD}	Supply Voltage			2.7 5.5	V (min) V (max)
I_{DD}	Quiescent Power Supply Current	$V_O = 0V$, $I_O = 0A$ (Note 8)	7.0	15.0	mA (max)
I_{SD}	Shutdown Current	$V_{pin2} = V_{DD}$ (Note 9)	0.6		μA
V_{OS}	Output Offset Voltage	$V_{IN} = 0V$	5.0	50.0	mV (max)
P_O	Output Power	THD+N = 1% (max); $f = 1$ kHz	1.15	1.0	W (min)
THD+N	Total Harmonic Distortion + Noise	$P_O = 1$ Wrms; 20 Hz $\leq f \leq 20$ kHz	0.72		%
PSRR	Power Supply Rejection Ratio	$V_{DD} = 4.9V$ to $5.1V$	65		dB
V_{od}	Output Dropout Voltage	$V_{IN} = 0V$ to $5V$, $V_{od} = (V_{o1} - V_{o2})$	0.6	1.0	V (max)
V_{IH}	HP-IN High Input Voltage	HP-SENSE = $0V$ to $4V$	2.5		V
V_{IL}	HP-IN Low Input Voltage	HP-SENSE = $4V$ to $0V$	2.5		V
V_{OH}	HP-SENSE High Output Voltage	$I_O = 500 \mu A$	2.8	2.5	V (min)
V_{OL}	HP-SENSE Low Output Voltage	$I_O = -500 \mu A$	0.2	0.8	V (max)

Note 1: All voltages are measured with respect to the ground pins, unless otherwise specified.

Note 2: Absolute Maximum Ratings indicate limits beyond which damage to the device may occur. Operating Ratings indicate conditions for which the device is functional, but do not guarantee specific performance limits. Electrical Characteristics state DC and AC electrical specifications under particular test conditions which guarantee specific performance limits. This assumes that the device is within the Operating Ratings. Specifications are not guaranteed for parameters where no limit is given, however, the typical value is a good indication of device performance.

Note 3: The maximum power dissipation must be derated at elevated temperatures and is dictated by T_{JMAX} , θ_{JA} , and the ambient temperature T_A . The maximum allowable power dissipation is $P_{DMAX} = (T_{JMAX} - T_A)/\theta_{JA}$ or the number given in the Absolute Maximum Ratings, whichever is lower. For the LM4860, $T_{JMAX} = +150^\circ C$, and the typical junction-to-ambient thermal resistance, when board mounted, is $100^\circ C/W$.

Note 4: Human body model, 100 pF discharged through a 1.5 k Ω resistor.

Note 5: Machine Model, 200 pF–240 pF discharged through all pins.

Note 6: Typicals are measured at $25^\circ C$ and represent the parametric norm.

Note 7: Limits are guaranteed to National's AOQL (Average Outgoing Quality Level).

Note 8: The quiescent power supply current depends on the offset voltage when a practical load is connected to the amplifier.

Note 9: Shutdown current has a wide distribution. For Power Management sensitive designs, contact your local National Semiconductor Sales Office.

High Gain Application Circuit

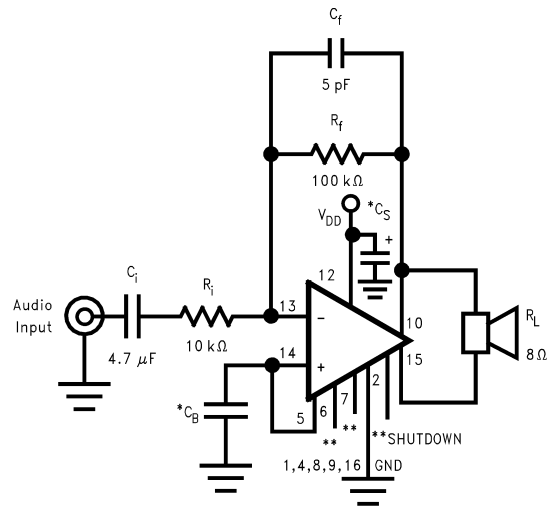

DS011988-3

FIGURE 2. Stereo Amplifier with $A_{VD} = 20$

Single Ended Application Circuit

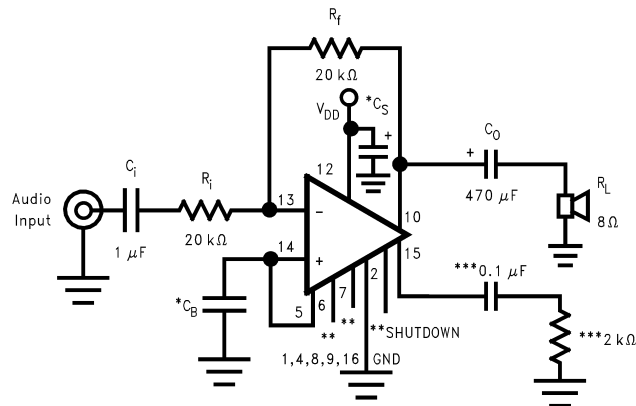

DS011988-4

* C_S and C_B size depend on specific application requirements and constraints. Typical values of C_S and C_B are 0.1 μF .

**Pin 2, 6, or 7 should be connected to V_{DD} to disable the amplifier or to GND to enable the amplifier. These pins should not be left floating.

***These components create a "dummy" load for pin 8 for stability purposes.

FIGURE 3. Single-Ended Amplifier with $A_V = -1$

External Components Description

(Figures 1, 2)

Components	Functional Description
1. R_i	Inverting input resistance which sets the closed-loop gain in conjunction with R_f . This resistor also forms a high pass filter with C_i at $f_c = 1/(2\pi R_i C_i)$.
2. C_i	Input coupling capacitor which blocks DC voltage at the amplifier's input terminals. Also creates a highpass filter with R_i at $f_c = 1/(2\pi R_i C_i)$.
3. R_f	Feedback resistance which sets closed-loop gain in conjunction with R_i .
4. C_S	Supply bypass capacitor which provides power supply filtering. Refer to the Application Information section for proper placement and selection of supply bypass capacitor.

Single Ended Application Circuit (Continued)

External Components Description (Continued)

(Figures 1, 2)

Components	Functional Description
5. C_B	Bypass pin capacitor which provides half supply filtering. Refer to Application Information section for proper placement and selection of bypass capacitor.
6. C_f (Note 10)	Used when a differential gain of over 10 is desired. C_f in conjunction with R_f creates a low-pass filter which bandwidth limits the amplifier and prevents high frequency oscillation bursts. $f_c = 1/(2\pi R_f C_f)$

Note 10: Optional component dependent upon specific design requirements. Refer to the **Application Information** section for more information.

Typical Performance Characteristics

THD+N vs Frequency

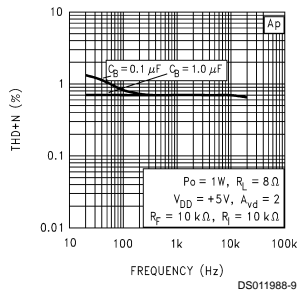

THD+N vs Frequency

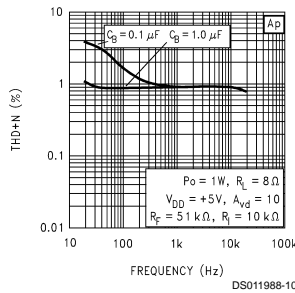

THD+N vs Frequency

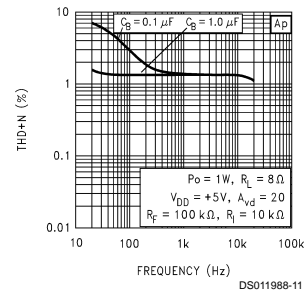

THD+N vs Output Power

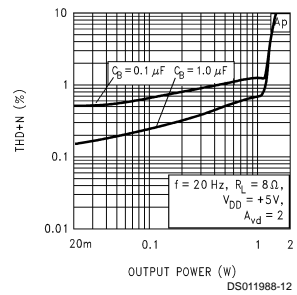

THD+N vs Output Power

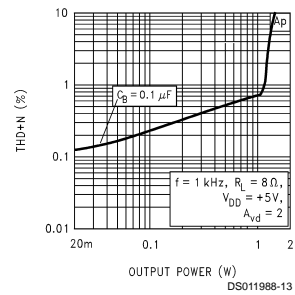

THD+N vs Output Power

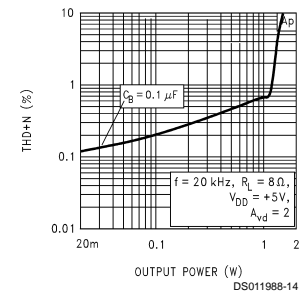

Supply Current vs Time in Shutdown Mode

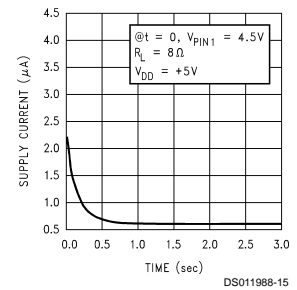

Supply Current vs Supply Voltage

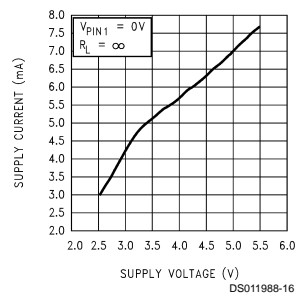

Power Derating Curve

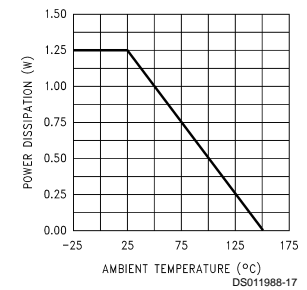

Typical Performance Characteristics (Continued)

LM4860 Noise Floor vs Frequency

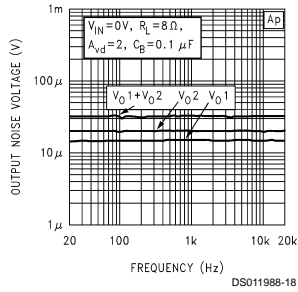

Supply Current Distribution vs Temperature

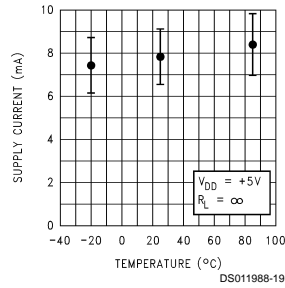

Power Dissipation vs Output Power

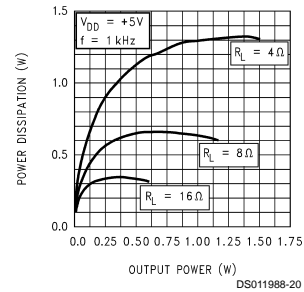

Output Power vs Load Resistance

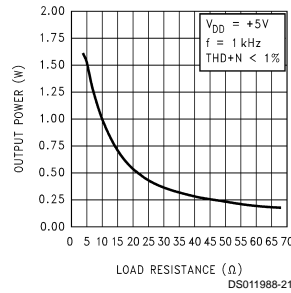

Output Power vs Supply Voltage

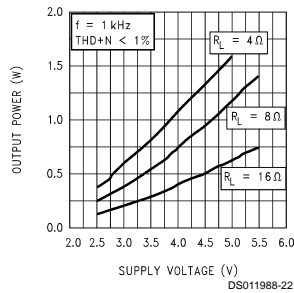

Open Loop Frequency Response

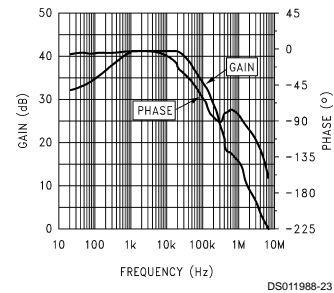

Power Supply Rejection Ratio

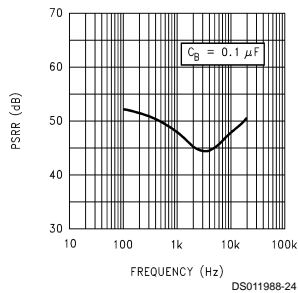

Application Information

BRIDGE CONFIGURATION EXPLANATION

As shown in *Figure 1*, the LM4860 has two operational amplifiers internally, allowing for a few different amplifier configurations. The first amplifier's gain is externally configurable, while the second amplifier is internally fixed in a unity-gain, inverting configuration. The closed-loop gain of the first amplifier is set by selecting the ratio of R_f to R_i while the second amplifier's gain is fixed by the two internal 40 k Ω resistors. *Figure 1* shows that the output of amplifier one serves as the input to amplifier two which results in both am-

plifiers producing signals identical in magnitude, but out of phase 180°. Consequently, the differential gain for the IC is:

$$A_{vd} = 2 * (R_f/R_i)$$

By driving the load differentially through outputs V_{O1} and V_{O2} , an amplifier configuration commonly referred to as "bridged mode" is established. Bridged mode operation is different from the classical single-ended amplifier configuration where one side of its load is connected to ground.

A bridge amplifier design has a few distinct advantages over the single-ended configuration, as it provides differential drive to the load, thus doubling output swing for a specified

Application Information (Continued)

supply voltage. Consequently, four times the output power is possible as compared to a single-ended amplifier under the same conditions. This increase in attainable output power assumes that the amplifier is not current limited or clipped. In order to choose an amplifier's closed-loop gain without causing excessive clipping which will damage high frequency transducers used in loudspeaker systems, please refer to the **Audio Power Amplifier Design** section.

A bridge configuration, such as the one used in Boomer Audio Power Amplifiers, also creates a second advantage over single-ended amplifiers. Since the differential outputs, V_{O1} and V_{O2} , are biased at half-supply, no net DC voltage exists across the load. This eliminates the need for an output coupling capacitor which is required in a single supply, single-ended amplifier configuration. Without an output coupling capacitor in a single supply single-ended amplifier, the half-supply bias across the load would result in both increased internal IC power dissipation and also permanent loudspeaker damage. An output coupling capacitor forms a high pass filter with the load requiring that a large value such as 470 μF be used with an 8 Ω load to preserve low frequency response. This combination does not produce a flat response down to 20 Hz, but does offer a compromise between printed circuit board size and system cost, versus low frequency response.

POWER DISSIPATION

Power dissipation is a major concern when designing a successful amplifier, whether the amplifier is bridged or single-ended. A direct consequence of the increased power delivered to the load by a bridge amplifier is an increase in internal power dissipation. Equation 1 states the maximum power dissipation point for a bridge amplifier operating at a given supply voltage and driving a specified output load.

$$P_{\text{DMAX}} = 4 * (V_{\text{DD}})^2 / (2\pi^2 R_L) \quad (1)$$

Since the LM4860 has two operational amplifiers in one package, the maximum internal power dissipation is 4 times that of a single-ended amplifier. Even with this substantial increase in power dissipation, the LM4860 does not require heatsinking. From Equation 1, assuming a 5V power supply and an 8 Ω load, the maximum power dissipation point is 625 mW. The maximum power dissipation point obtained from Equation 1 must not be greater than the power dissipation that results from Equation 2:

$$P_{\text{DMAX}} = (T_{\text{JMAX}} - T_{\text{A}}) / \theta_{\text{JA}} \quad (2)$$

For the LM4860 surface mount package, $\theta_{\text{JA}} = 100^\circ\text{C/W}$ and $T_{\text{JMAX}} = 150^\circ\text{C}$. Depending on the ambient temperature, T_{A} , of the system surroundings, Equation 2 can be used to find the maximum internal power dissipation supported by the IC packaging. If the result of Equation 1 is greater than that of Equation 2, then either the supply voltage must be decreased or the load impedance increased. For the typical application of a 5V power supply, with an 8 Ω load, the maximum ambient temperature possible without violating the maximum junction temperature is approximately 88 $^\circ\text{C}$, provided that device operation is around the maximum power dissipation point. Power dissipation is a function of output power and thus, if typical operation is not around the maximum power dissipation point, the ambient temperature can be increased. Refer to the **Typical Performance Characteristics** curves for power dissipation information for lower output powers.

POWER SUPPLY BYPASSING

As with any power amplifier, proper supply bypassing is critical for low noise performance and high power supply rejection. The capacitor location on both the bypass and power supply pins should be as close to the device as possible. As displayed in the **Typical Performance Characteristics** section, the effect of a larger half-supply bypass capacitor is improved low frequency THD+N due to increased half-supply stability. Typical applications employ a 5V regulator with 10 μF and a 0.1 μF bypass capacitors which aid in supply stability, but do not eliminate the need for bypassing the supply nodes of the LM4860. The selection of bypass capacitors, especially C_{B} , is thus dependant upon desired low frequency THD+N, system cost, and size constraints.

SHUTDOWN FUNCTION

In order to reduce power consumption while not in use, the LM4860 contains a shutdown pin to externally turn off the amplifier's bias circuitry. The shutdown feature turns the amplifier off when a logic high is placed on the shutdown pin. Upon going into shutdown, the output is immediately disconnected from the speaker. There is a built-in threshold which produces a drop in quiescent current to 500 μA typically. For a 5V power supply, this threshold occurs when 2V–3V is applied to the shutdown pin. A typical quiescent current of 0.6 μA results when the supply voltage is applied to the shutdown pin. In many applications, a microcontroller or microprocessor output is used to control the shutdown circuitry which provides a quick, smooth transition into shutdown. Another solution is to use a single-pole, single-throw switch that when closed, is connected to ground and enables the amplifier. If the switch is open, then a soft pull-up resistor of 47 k Ω will disable the LM4860. There are no soft pull-down resistors inside the LM4860, so a definite shutdown pin voltage must be applied externally, or the internal logic gate will be left floating which could disable the amplifier unexpectedly.

HEADPHONE CONTROL INPUTS

The LM4860 possesses two headphone control inputs that disable the amplifier and reduce I_{DD} to less than 1 mA when either one or both of these inputs have a logic-high voltage placed on their pins.

Unlike the shutdown function, the headphone control function does not provide the level of current conservation that is required for battery powered systems. Since the quiescent current resulting from the headphone control function is 1000 times more than the shutdown function, the residual currents in the device may create a pop at the output when coming out of the headphone control mode. The pop effect may be eliminated by connecting the headphone sensing output to the shutdown pin input as shown in *Figure 4*. This solution will not only eliminate the output pop, but will also utilize the full current conservation of the shutdown function by reducing I_{DD} to 0.6 μA . The amplifier will then be fully shutdown. This configuration also allows the designer to use the control inputs as either two headphone control pins or a headphone control pin and a shutdown pin where the lowest level of current consumption is obtained from either function.

Figure 5 shows the implementation of the LM4860's headphone control function using a single-supply headphone amplifier. The voltage divider of R1 and R2 sets the voltage at the HP-IN1 pin to be approximately 50 mV when there are no headphones plugged into the system. This logic-low voltage at the HP-IN1 pin enables the LM4860 to amplify AC signals. Resistor R3 limits the amount of current flowing out of the HP-IN1 pin when the voltage at that pin goes below

Application Information (Continued)

HIGHER GAIN AUDIO AMPLIFIER

The LM4860 is unity-gain stable and requires no external components besides gain-setting resistors, an input coupling capacitor, and proper supply bypassing in the typical application. However if a closed-loop differential gain of greater than 10 is required, then a feedback capacitor is needed, as shown in *Figure 2*, to bandwidth limit the amplifier. The feedback capacitor creates a low pass filter that eliminates unwanted high frequency oscillations. Care should be taken when calculating the -3 dB frequency in that an incorrect combination of R_f and C_f will cause rolloff before 20 kHz. A typical combination of feedback resistor and capacitor that will not produce audio band high frequency rolloff is $R_f = 100$ k Ω and $C_f = 5$ pF. These components result in a -3 dB point of approximately 320 kHz. Once the differential gain of the amplifier has been calculated, a choice of R_f will result, and C_f can then be calculated from the formula stated in the **External Components Description** section.

VOICE-BAND AUDIO AMPLIFIER

Many applications, such as telephony, only require a voice-band frequency response. Such an application usually requires a flat frequency response from 300 Hz to 3.5 kHz. By adjusting the component values of *Figure 2*, this common application requirement can be implemented. The combination of R_i and C_i form a highpass filter while R_f and C_f form a lowpass filter. Using the typical voice-band frequency range, with a passband differential gain of approximately 100, the following values of R_i , C_i , R_f , and C_f follow from the equations stated in the **External Components Description** section.

$$R_i = 10 \text{ k}\Omega, R_f = 510\text{k}, C_i = 0.22 \mu\text{F}, \text{ and } C_f = 15 \text{ pF}$$

Five times away from a -3 dB point is 0.17 dB down from the flatband response. With this selection of components, the resulting -3 dB points, f_{l-3} and f_{h-3} , are 72 Hz and 20 kHz, respectively, resulting in a flatband frequency response of better than ± 0.25 dB with a rolloff of 6 dB/octave outside of the passband. If a steeper rolloff is required, other common bandpass filtering techniques can be used to achieve higher order filters.

SINGLE-ENDED AUDIO AMPLIFIER

Although the typical application for the LM4860 is a bridged monoaural amp, it can also be used to drive a load single-endedly in applications, such as PC cards, which require that one side of the load is tied to ground. *Figure 3* shows a common single-ended application, where V_{O1} is used to drive the speaker. This output is coupled through a 470 μF capacitor, which blocks the half-supply DC bias that exists in all single-supply amplifier configurations. This capacitor, designated C_O in *Figure 3*, in conjunction with R_L , forms a highpass filter. The -3 dB point of this highpass filter is $1/(2\pi R_L C_O)$, so care should be taken to make sure that the product of R_L and C_O is large enough to pass low frequencies to the load. When driving an 8 Ω load, and if a full audio spectrum reproduction is required, C_O should be at least 470 μF . V_{O2} , the output that is not used, is connected through a 0.1 μF capacitor to a 2 k Ω load to prevent instabil-

ity. While such an instability will not affect the waveform of V_{O1} , it is good design practice to load the second output.

AUDIO POWER AMPLIFIER DESIGN

Design a 500 mW/8 Ω Audio Amplifier

Given:

Power Output: 500 mW_{rms}

Load Impedance: 8 Ω

Input Level: 1 V_{rms}(max)

Input Impedance: 20 k Ω

Bandwidth: 20 Hz-20 kHz ± 0.25 dB

A designer must first determine the needed supply rail to obtain the specified output power. Calculating the required supply rail involves knowing two parameters, V_{opeak} and also the dropout voltage. The latter is typically 0.7V. V_{opeak} can be determined from equation 3.

$$V_{\text{opeak}} = \sqrt{(2 R_L P_O)} \quad (3)$$

For 500 mW of output power into an 8 Ω load, the required V_{opeak} is 2.83V. A minimum supply rail of 3.53V results from adding V_{opeak} and V_{od} . But 3.53V is not a standard voltage that exists in many applications and for this reason, a supply rail of 5V is designated. Extra supply voltage creates dynamic headroom that allows the LM4860 to reproduce peaks in excess of 500 mW without clipping the signal. At this time, the designer must make sure that the power supply choice along with the output impedance does not violate the conditions explained in the **Power Dissipation** section.

Once the power dissipation equations have been addressed, the required differential gain can be determined from Equation 4.

$$A_{\text{vd}} \geq 2 * \sqrt{(P_O R_L)} / (V_{\text{IN}}) = V_{\text{orms}} / V_{\text{inrms}} \quad (4)$$

$$R_f / R_i = A_{\text{vd}} / 2 \quad (5)$$

From equation 4, the minimum A_{vd} is: $A_{\text{vd}} = 2$

Since the desired input impedance was 20 k Ω , and with an A_{vd} of 2, a ratio of 1:1 of R_f to R_i results in an allocation of $R_f = R_i = 20$ k Ω . Since the A_{vd} was less than 10, a feedback capacitor is not needed. The final design step is to address the bandwidth requirements which must be stated as a pair of -3 dB frequency points. Five times away from a -3 dB point is 0.17 dB down from passband response which is better than the required ± 0.25 dB specified. This fact results in a low and high frequency pole of 4 Hz and 100 kHz respectively. As stated in the **External Components** section, R_i in conjunction with C_i create a highpass filter.

$$C_i \geq 1 / (2\pi * 20 \text{ k}\Omega * 4 \text{ Hz}) = 1.98 \mu\text{F}; \text{ use } 2.2 \mu\text{F}.$$

The high frequency pole is determined by the product of the desired high frequency pole, f_{H-3} , and the differential gain, A_{vd} . With a $A_{\text{vd}} = 2$ and $f_{H-3} = 100$ kHz, the resulting GBWP = 100 kHz which is much smaller than the LM4860 GBWP of 7 MHz. This figure displays that if a designer has a need to design an amplifier with a higher differential gain, the LM4860 can still be used without running into bandwidth problems.

Physical Dimensions inches (millimeters) unless otherwise noted

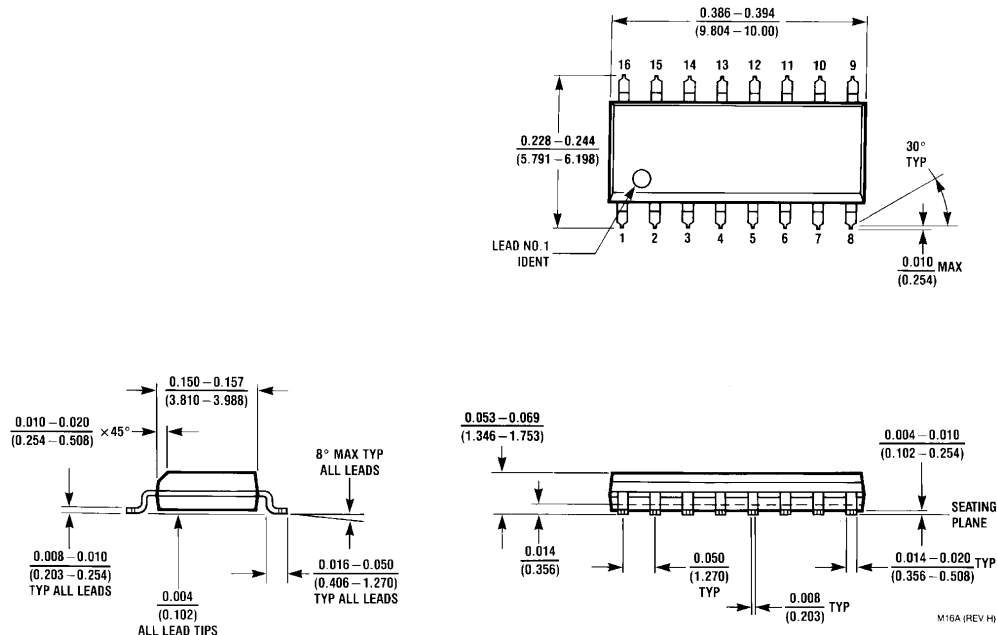

**Small Outline Package (M)
Order Number LM4860M
NS Package Number M16A**

LIFE SUPPORT POLICY

NATIONAL'S PRODUCTS ARE NOT AUTHORIZED FOR USE AS CRITICAL COMPONENTS IN LIFE SUPPORT DEVICES OR SYSTEMS WITHOUT THE EXPRESS WRITTEN APPROVAL OF THE PRESIDENT AND GENERAL COUNSEL OF NATIONAL SEMICONDUCTOR CORPORATION. As used herein:

1. Life support devices or systems are devices or systems which, (a) are intended for surgical implant into the body, or (b) support or sustain life, and whose failure to perform when properly used in accordance with instructions for use provided in the labeling, can be reasonably expected to result in a significant injury to the user.
2. A critical component is any component of a life support device or system whose failure to perform can be reasonably expected to cause the failure of the life support device or system, or to affect its safety or effectiveness.

 <p>National Semiconductor Corporation Americas Tel: 1-800-272-9959 Fax: 1-800-737-7018 Email: support@nsc.com www.national.com</p>	<p>National Semiconductor Europe Fax: +49 (0) 1 80-530 85 86 Email: europe.support@nsc.com Deutsch Tel: +49 (0) 1 80-530 85 85 English Tel: +49 (0) 1 80-532 78 32 Français Tel: +49 (0) 1 80-532 93 58 Italiano Tel: +49 (0) 1 80-534 16 80</p>	<p>National Semiconductor Asia Pacific Customer Response Group Tel: 65-2544466 Fax: 65-2504466 Email: sea.support@nsc.com</p>	<p>National Semiconductor Japan Ltd. Tel: 81-3-5639-7560 Fax: 81-3-5639-7507</p>
--	---	--	---

National does not assume any responsibility for use of any circuitry described, no circuit patent licenses are implied and National reserves the right at any time without notice to change said circuitry and specifications.