

## Series PVY116

Microelectronic Power IC  
HEXFET® Power MOSFET Photovoltaic Relay  
Single-Pole, Normally-Open, 0-40V AC/DC, 250mA

### General Description

The PVY116 Series Photovoltaic Relay is a single-pole, normally-open solid-state relay that can replace dry and Mercury-wetted reed relays in many applications. It utilizes International Rectifier's proprietary HEXFET power MOSFET as the output switch, driven by an integrated circuit photovoltaic generator of novel construction. The output switch is controlled by radiation from a GaAlAs light emitting diode (LED), which is optically isolated from the photovoltaic generator.

The PVY116 is ideally suited for use as matrix relay in low voltage ATE applications and general instrumentation applications involving high frequency test signals. This can be accomplished thanks to the extremely low Figure Of Merit ( $FOM = Coff * Ron$ ), which is the product of the relay's off-state output capacitance and on-state resistance.

The PVY116 is packaged in a 4-pin, molded small outline package (SOP-4) with surface mount (gull wing) terminals. It is available in plastic shipping tubes or on tape-and-reel. Please refer to Part Identification information.

### Applications

- Automated Test Equipment
- Instrumentation
- Data Acquisition

### Features

- Low signal distortion at high frequencies
- Low  $Coff * Ron$  Figure Of Merit
- High off-state resistance
- Bounce-free operation
- 1,500 V<sub>RMS</sub> I/O isolation
- Long operational life
- Solid-State Reliability
- ESD Tolerance 2000V Human Body Model

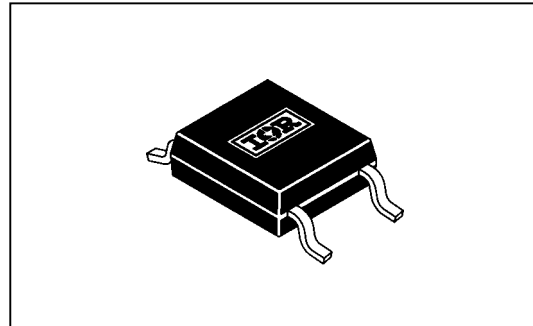

### Part Identification

|          |                              |
|----------|------------------------------|
| PVY116   | surface-mount                |
| PVY116-T | surface-mount, tape-and-reel |

## Series PVY116

International  
IR Rectifier

### Electrical Specifications (-40°C ≤ T<sub>A</sub> ≤ +85°C unless otherwise specified)

| INPUT CHARACTERISTICS  | Units | Min | Typ | Max  |
|--|-------|-----|-----|------|
| Minimum control current (see Figure 1)                                 | mA    | 2.0 | —   | —    |
| Control current for off-state resistance @ T <sub>A</sub> = +25°C      | mA    | —   | —   | 0.2  |
| Control current range (caution: current limit input LED, see Figure 8) | mA    | 2.0 | —   | 20.0 |
| Reverse voltage (1mA max.)   | V     | —   | —   | 7.0  |

| OUTPUT CHARACTERISTICS  | Units  | Min | Typ  | Max |
|---|--------|-----|------|-----|
| Operating voltage range   | V peak | —   | —    | 40  |
| Continuous load current @ 40°C, 5mA control (see Figure 1)  | mA     | —   | —    | 250 |
| Pulsed load current @ 25°C, 5mA control (see Figure 2 and 3)<br>10ms on, 10% duty cycle           | mA     | —   | —    | 420 |
| Off-state leakage @ 32V, 25°C, (see Figure 4)   | nA     | —   | 0.02 | 1.0 |
| On-state resistance @ 5mA control, I <sub>L</sub> =100mA (see Figure 2 and 3)                     | Ω      | —   | 3.8  | 4.4 |
| Output capacitance V <sub>d</sub> =0V, f=1MHz (C <sub>out</sub> , see Figure 7)                   | pF     | —   | 2.4  | 3.0 |
| C * R (R <sub>DDon</sub> x C <sub>out</sub> )   | pF * Ω | —   | 9.1  | —   |
| Turn-on time, 5mA control, 100Ω, 20V (T <sub>on</sub> , see Figure 5)<br>1ms on, 50% duty cycle   | μS     | —   | 110  | 500 |
| Turn-off time, 5mA control, 100Ω, 20V (T <sub>off</sub> , see Figure 5)<br>1ms on, 50% duty cycle | μS     | —   | 100  | 500 |

| GENERAL CHARACTERISTICS   | Units            | Min              | Typ | Max  |
|---|------------------|------------------|-----|------|
| Dielectric strength, Input to Output  | V <sub>RMS</sub> | 1500             | —   | —    |
| Insulation Resistance, Input to Output  | Ω                | 10 <sup>12</sup> | —   | —    |
| C <sub>I-O</sub> (Input to Output Capacitance), V <sub>d</sub> = 0V, f = 1MHz | pF               | —                | 0.8 | —    |
| Max. pin soldering temperature (10 seconds max.)                              | °C               |                  |     | +260 |
| Ambient temperature range:     Operating                                      | °C               | -40              |     | +85  |
| Storage   | °C               | -40              |     | +100 |

International Rectifier does not recommend the use of this product in aerospace, avionics, military or life support applications. Users of this International Rectifier product in such applications assume all risks of such use and indemnify International Rectifier against all damages resulting from such use.

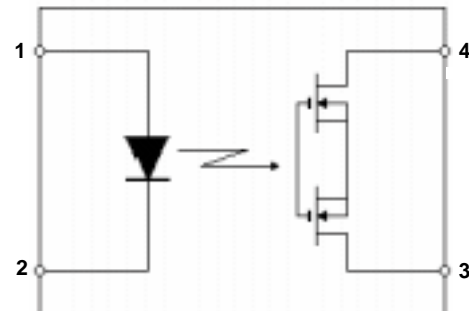

Connection Diagram

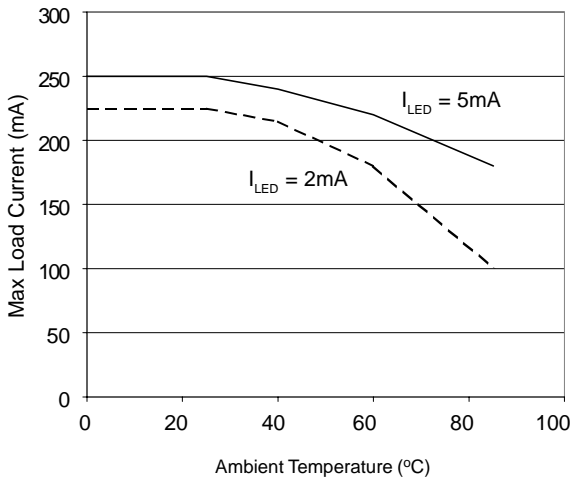

Figure 1. Current Derating Curves

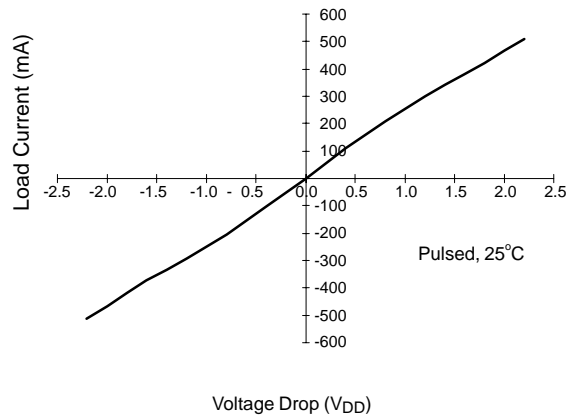

Figure 2. Typical On Characteristics

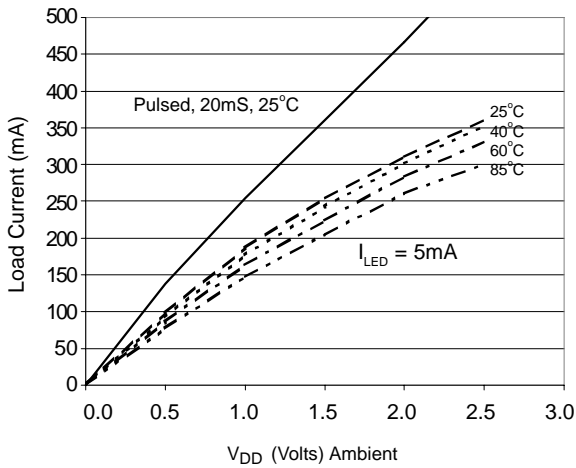

Figure 3. Typical On Characteristics

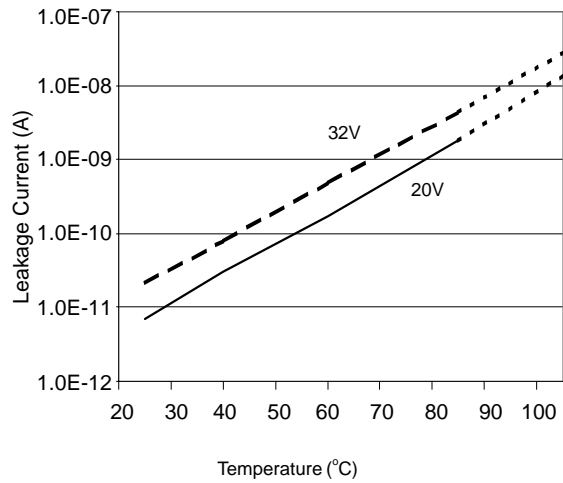

Figure 4. Typical Leakage Characteristics

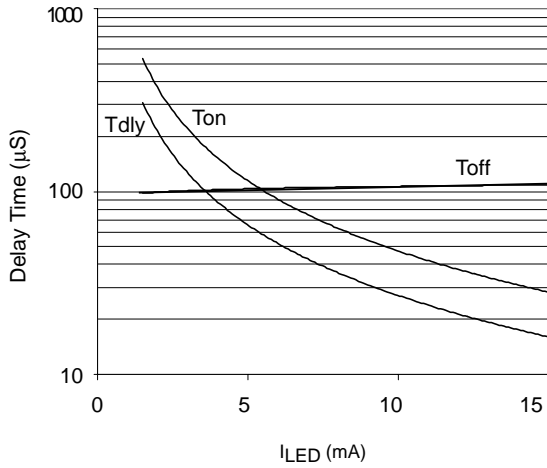

Figure 5. Typical Delay Times

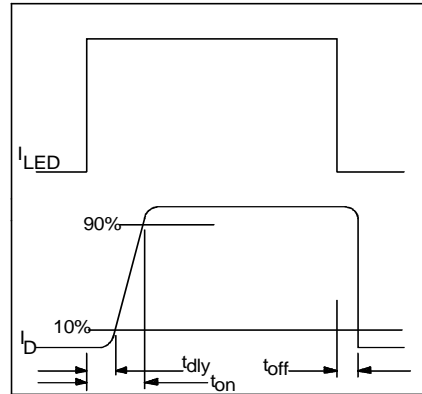

Figure 6. Delay Time Definitions

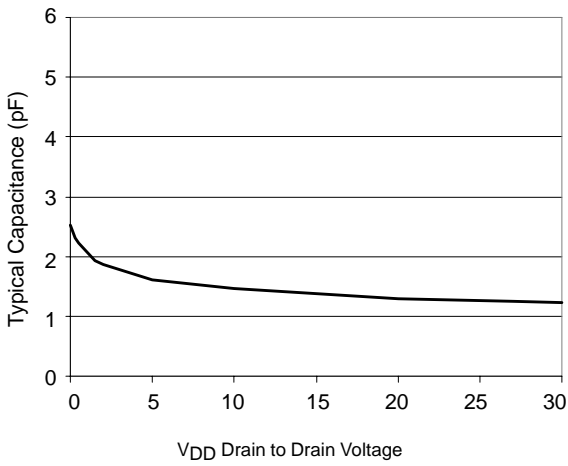

Figure 7. Output Capacitance

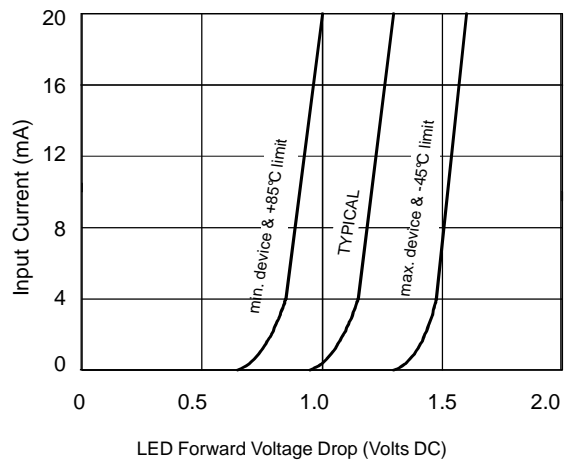

Figure 8. Input Characteristics (Current Controlled)

**Case Outlines - 4 Lead SOP**

