

**FULLY PROTECTED POWER MOSFET SWITCH**

**General Description:**

The IRSF3010 is a three terminal monolithic SMART POWER MOSFET with built in short circuit, over-temperature, ESD and over-voltage protections.

The on chip protection circuit latches off the POWER MOSFET in case the drain current exceeds 14A (typical) or the junction temperature exceeds 165°C (typical) and keeps it off until the input is driven low. The drain to source voltage is actively clamped at 55V (typical), prior to the avalanche of POWER MOSFET, thus improving its performance during turn off with inductive loads.

The input current requirements are very low (300uA) which makes the IRSF3010 compatible with most existing designs based on standard POWER MOSFETs.

**Applications:**

- DC Motor Drive
- Solenoid Driver

**Rating Summary:**

$V_{ds(clamp)}$	<b>50 V</b>
$R_{ds(on)}$	<b>80 mΩ</b>
$I_{ds(sd)}$	<b>11 A</b>
$T_{j(sd)}$	<b>155 °C</b>
$E_{AS}$	<b>400 mJ</b>

**Features:**

- Extremely Rugged for Harsh Operating Environments
- Over Temperature Protection
- Over Current Protection
- Active Drain to Source Clamp
- ESD Protection
- Compatible with standard POWER MOSFET
- Low Operating Input Current
- Monolithic Construction
- Dual set/reset Threshold Input

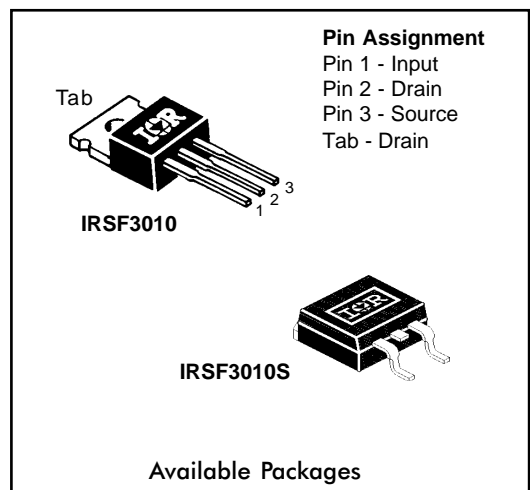
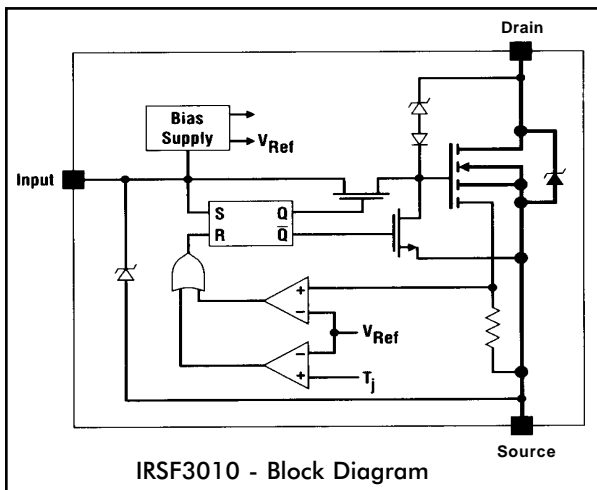

## Absolute Maximum Ratings

Absolute Maximum Ratings indicate sustained limits beyond which damage to the device may occur. ( $T_C = 25^\circ\text{C}$  unless otherwise specified.)

Symbol	Parameter Definition	Min.	Max.	Units	Test Conditions
$V_{ds, \max}$	Continuous Drain to Source Voltage	—	50	V	
$V_{in, \max}$	Continuous Input Voltage	-0.3	10		
$I_{ds}$	Continuous Drain Current	—	self limited		
$P_d$	Power Dissipation	—	40	W	$T_C \leq 25^\circ\text{C}$
	Linear Derating Factor for $T_C > 25^\circ\text{C}$	—	0.33	W/ $^\circ\text{C}$	
EAS	Unclamped Single Pulse Inductive Energy	—	400	mJ	
$V_{esd1}$	Electrostatic Discharge Voltage (Human Body Model) (Machine Model)	—	4000	V	1000pF, 1.5k $\Omega$ 200pF, 0 $\Omega$
$V_{esd2}$		—	1000		
$T_{Jop}$	Junction Temperature	-55	self-limited	$^\circ\text{C}$	
$T_{Stg}$	Storage Temperature	-55	175		
$T_L$	Lead Temperature (Soldering, 10 seconds)	—	300		

## Static Electrical Characteristics

( $T_C = 25^\circ\text{C}$  unless otherwise specified.)

Symbol	Parameter Definition	Min.	Typ.	Max.	Units	Test Conditions
$V_{ds, \text{clamp}}$	Drain to Source Clamp Voltage	50	54	—	V	$I_{ds} = 10\text{mA}$
		—	56	62		$I_{ds} = 11\text{A}, t_p = 700 \mu\text{S}$
$R_{ds(\text{on})}$	Drain to Source On Resistance	—	70	80	m $\Omega$	$V_{in} = 5\text{V}, I_{ds} = 4\text{A}$
		—	85	—		$V_{in} = 4\text{V}, I_{ds} = 4\text{A}$
		—	53	—		$V_{in} = 10\text{V}, I_{ds} = 4\text{A}$
$I_{dss}$	Drain to Source Leakage Current	—	—	10	$\mu\text{A}$	$V_{ds} = 12\text{V}, V_{in} = 0\text{V}$
		—	—	100		$V_{ds} = 50\text{V}, V_{in} = 0\text{V}$
		—	10	250		$V_{ds} = 40\text{V}, V_{in} = 0\text{V}, T_C = 150^\circ\text{C}$
$V_{th}$	Input Threshold Voltage	1.5	2.0	2.5	V	$V_{ds} = 5\text{V}, I_{ds} = 1\text{mA}$
$I_{i, \text{on}}$	Input Supply Current (Normal Operation)	—	0.25	0.6	mA	$V_{in} = 5\text{V}$
		—	0.35	0.85		$V_{in} = 10\text{V}$
$I_{i, \text{off}}$	Input Supply Current (Protection Mode)	—	0.5	1.0		$V_{in} = 5\text{V}$
		—	0.6	1.2		$V_{in} = 10\text{V}$
$V_{in, \text{clamp}}$	Input Clamp Voltage	10	10.8	—	V	$I_{in} = 10\text{mA}$
$V_{sd}$	Body-Drain Diode Forward Drop ②	—	1.2	1.5	V	$I_{ds} = -17\text{A}, R_{in} = 1\text{k}\Omega$

## Thermal Characteristics

Symbol	Parameter Definition	Min.	Typ.	Max.	Units	Test Conditions
$R_{\theta jc}$	Thermal Resistance, Junction to Case	—	3.0	—	$^\circ\text{C/W}$	
$R_{\theta jA}$	Thermal Resistance, Junction to Ambient	—	60	—	$^\circ\text{C/W}$	

## Switching Electrical Characteristics:

( $V_{CC} = 14V$ , Resistive Load  $R_L = 5\Omega$ ,  $T_C = 25^\circ C$ .) Please refer to Figure 15 for switching time definitions.

Symbol	Parameter Definition	Min.	Typ.	Max.	Units	Test Conditions
$t_{don}$	Turn-On Delay time	—	425	650	nS	$V_{in} = 5V$
		—	150	—		$V_{in} = 10V$
$t_r$	Rise Time	—	2000	4000		$V_{in} = 5V$
		—	425	—		$V_{in} = 10V$
$t_{doff}$	Turn-Off Delay time	—	650	1000		$V_{in} = 5V$
		—	850	—		$V_{in} = 10V$
$t_f$	Fall Time	—	500	800		$V_{in} = 5V$
		—	450	—		$V_{in} = 10V$

## Protection Characteristics:

( $T_C = 25^\circ C$  unless otherwise specified.)

Symbol	Parameter Definition	Min.	Typ.	Max.	Units	Test Conditions
$I_{ds(sd)}$	Over-Current Shutdown Threshold	11	14	17	A	$V_{in} = 5V$
$T_j(sd)$	Over Temperature Shutdown Threshold	155	165	—	$^\circ C$	$V_{in} = 5V$ , $I_{ds} = 2A$
$V_{protect}$	Minimum Input Voltage for Over-temp fxn.	—	3	—	V	
$t_{resp}$	Over Current Response Time	—	2	—	$\mu S$	See figure 16 for definition
$t_{blank}$	Over Current Blanking Time	—	3	—		See figure 16 for definition
$I_{peak}$	Peak Short Circuit Current	—	20	—	A	See figure 16 for definition
$V_{reset}$	Protection Reset Voltage	—	1.3	—	V	
$t_{reset}$	Protection Reset Time	—	7	—	$\mu S$	See figure 17 for definition
$t_{Tresp}$	OverTemperature Response Time	—	12	—		See figure 18 for definition

## Temperature Coefficients of Electrical Characteristics:

(Please see Figures 3 through 14 for more data on thermal characteristics of other electrical parameters.)

Symbol	Parameter Definition	Min.	Typ.	Max.	Units	Test Conditions
$V_{ds,clamp}$	Temperature Coefficient of Drain to Source Clamp Voltage	—	18.2	—	mV/ $^\circ C$	$I_{ds} = 10mA$
$V_{th}$	Temperature Coefficient of Input Threshold Voltage	—	-3.2	—		$V_{ds} = 5V$ , $I_{ds} = 1mA$
$V_{in,clamp}$	Temperature Coefficient of Input Clamp Voltage	—	7.0	—		$I_{in} = 10mA$
$I_{ds(sd)}$	Temperature Coefficient of Over-Current Shutdown Threshold	—	-21.5	—	mA/ $^\circ C$	$V_{in} = 5V$

### Notes:

- EAS is tested with a constant current source of 11A applied for 700 $\mu S$  with  $V_{in} = 0V$  and starting  $T_j = 25^\circ C$ .
- Input current must be limited to less than 5mA with a 1k $\Omega$  resistor in series with the input when the Body-Drain Diode is forward biased.

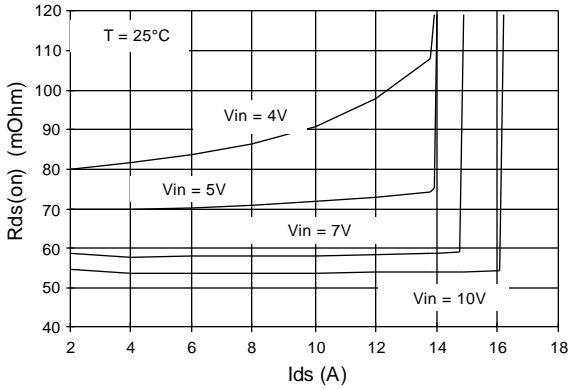

**Fig. 3 - On Resistance vs Drain to Source Current**

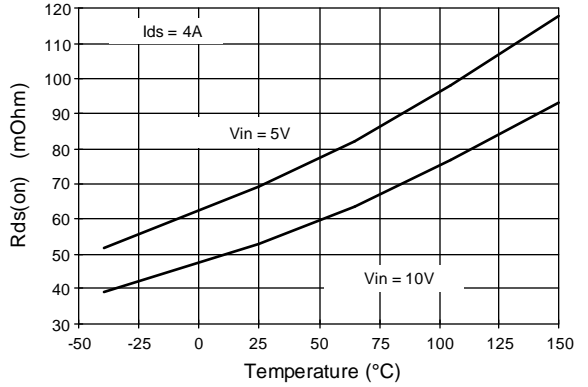

**Fig. 4 - On Resistance vs. Temperature**

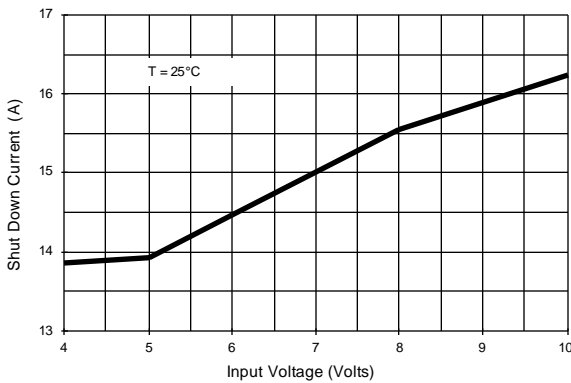

**Fig. 5 - Over-current Shutdown Threshold vs Input Voltage**

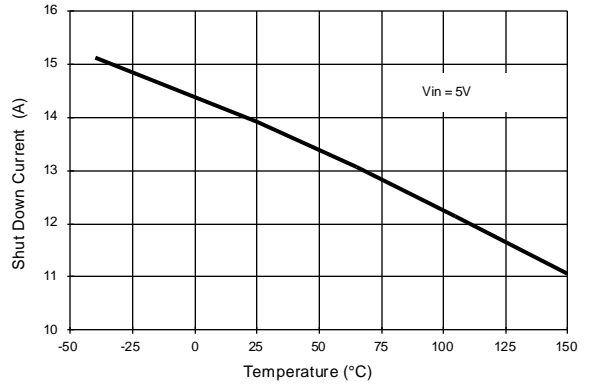

**Fig. 6 - Over-current Shutdown Threshold vs Temperature**

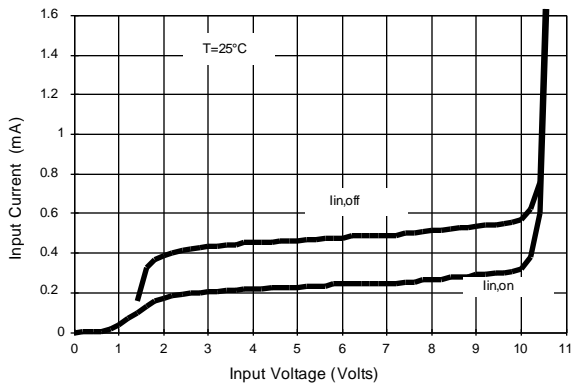

**Figure 7 - Input Current vs. Input Voltage**

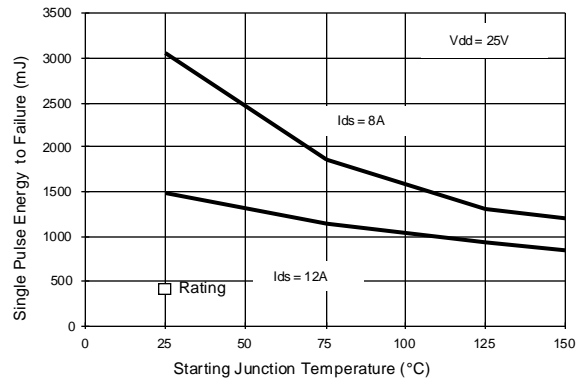

**Fig. 8 - Unclamped Single Pulse Inductive Energy to Failure vs Starting Junction Temperature**

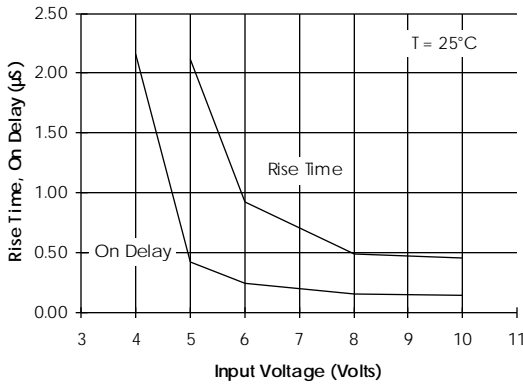

Fig. 9 - Turn on characteristics vs Input Voltage

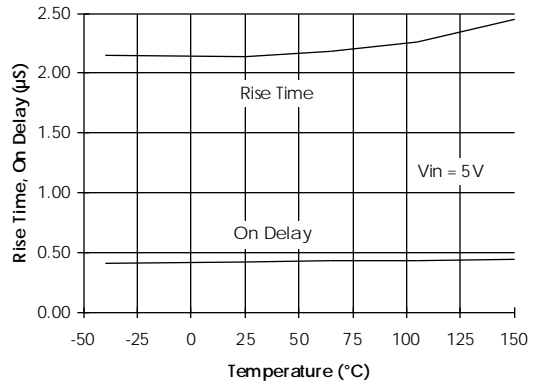

Fig. 10 - Turn on characteristics vs Temperature

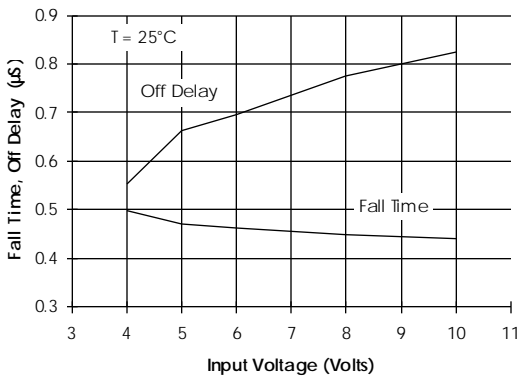

Fig. 11 - Turn off characteristics vs Input Voltage

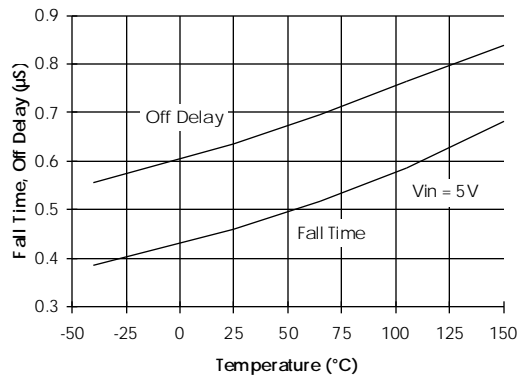

Fig. 12 - Turn off characteristics vs Temperature

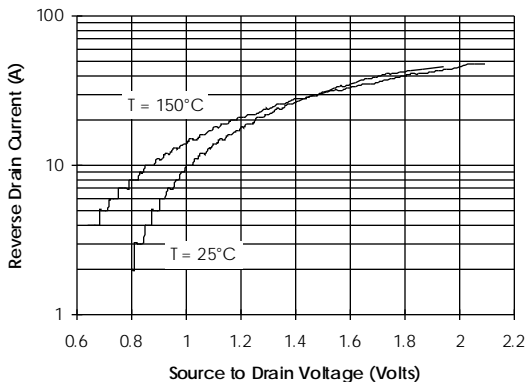

Fig. 13 - Source-Drain Diode Forward Voltage

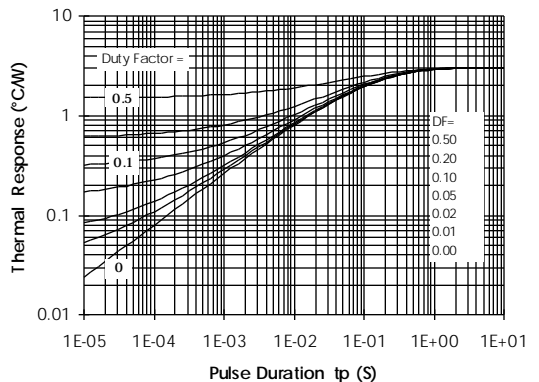

Fig. 14 - Transient Thermal Impedance, Junction to Case

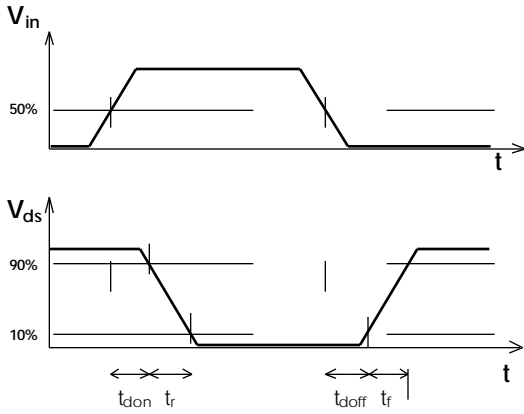

Fig. 15 - Definition of Switching times.

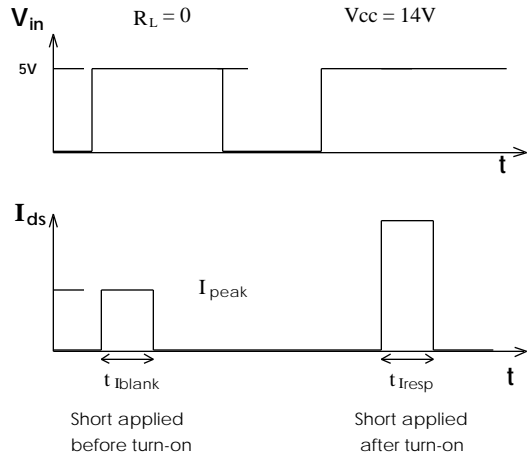

Fig. 16 - Definition of  $I_{peak}$ ,  $t_{blank}$ ,  $t_{resp}$

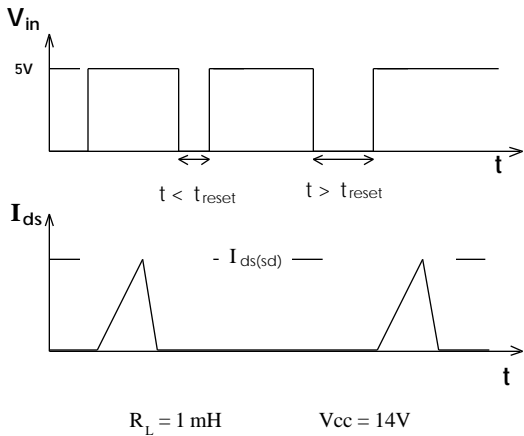

Fig. 17 - Definition of  $t_{reset}$

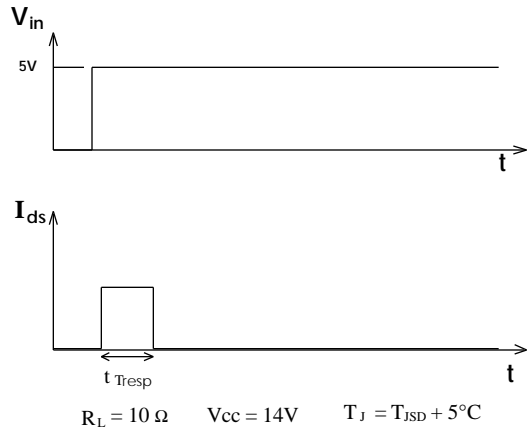
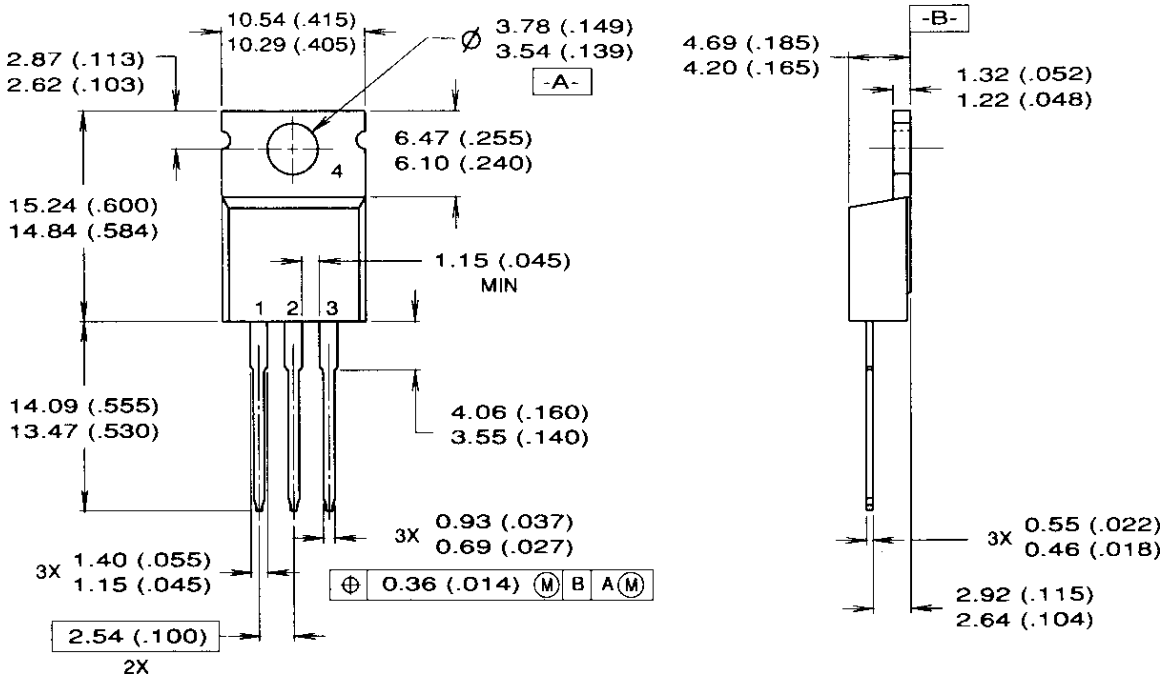

Fig. 18 - Definition of  $t_{Tresp}$

**Case Outline — TO-220AB (IRSF3010)**



**NOTES:**

1. Dimensioning and tolerancing per ANSI Y14.5M, 1982
2. Controlling dimension: INCH
3. Dimensions shown are in millimeters (inches)
4. Conforms to JEDEC outline TO-251AA
- ⑤ Dimension does not include solder dip. Solder dip max. +0.16 (.006)

**LEAD ASSIGNMENTS**

1. Gate
2. Drain
3. Source
4. Drain

## Case Outline — SMD-220 (IRSF3010S)

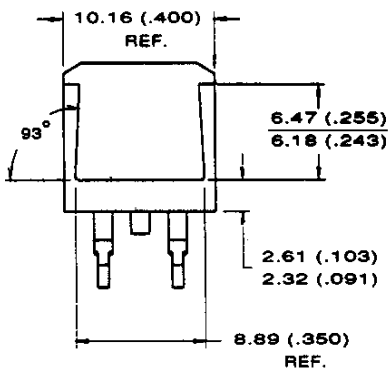
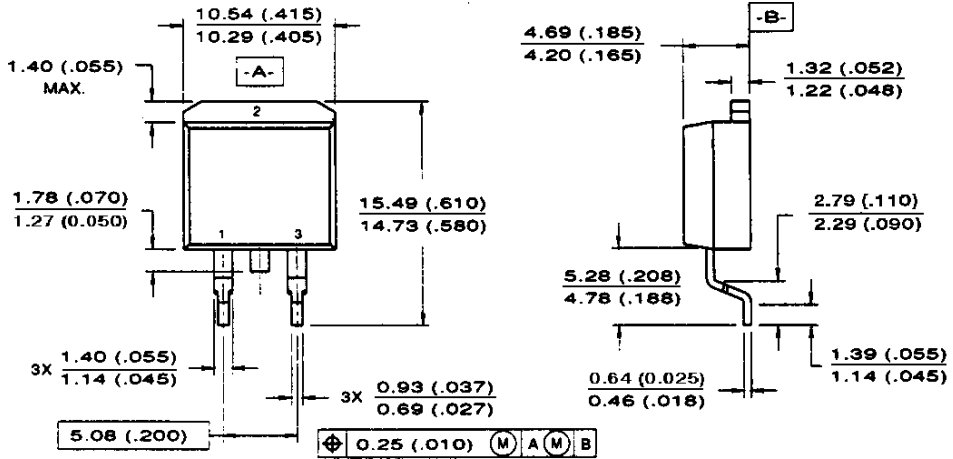

### MINIMUM RECOMMENDED FOOTPRINT

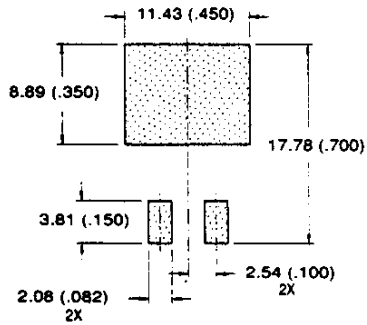



Tape and Reel — SMD-220 (IRSF3010S)

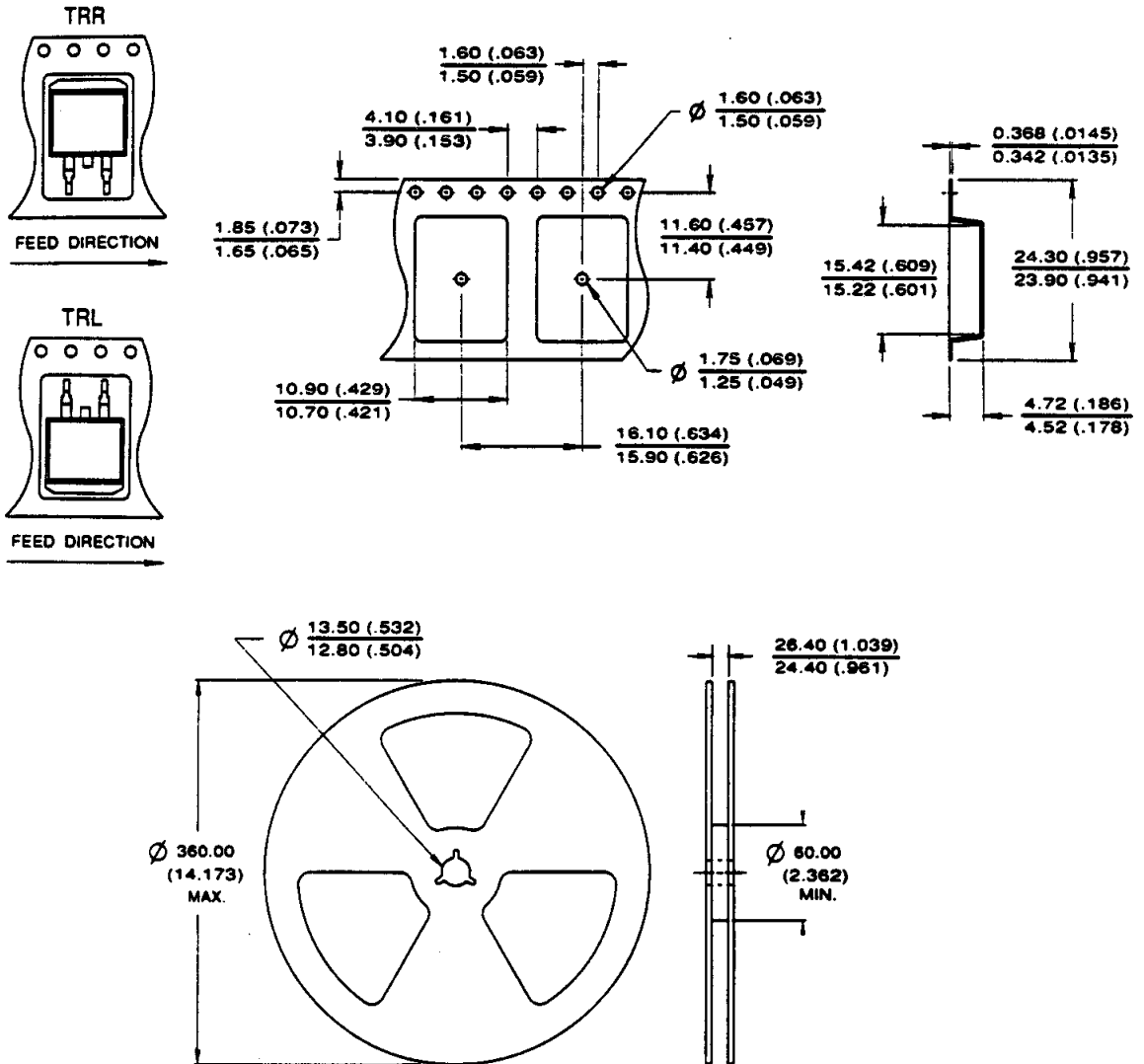

## Application Information

### Introduction

Protected monolithic POWER MOSFETs offer simple, cost effective solutions in applications where extreme operating conditions can occur. The margin between the operating conditions and the absolute maximum values can be narrowed resulting in better utilization of the device and lower cost. ESD protection also reduces the off-circuit failures during handling and assembly.

### General Description

The IRSF3010 is a fully protected monolithic N-channel, logic level POWER MOSFET with 80mΩ (max) on-resistance. The built-in protections include over-current, over-temperature, ESD and active over-voltage protections.

The over-current and over-temperature protection makes the IRSF3010 indestructible at any load conditions in switching or in linear applications. The built-in ESD protection minimizes the risk of ESD damage when the device is off-circuit. The IRSF3010 is fully characterized for avalanche operation and can be used for fast de-energization of inductive loads.

The IRSF3010 Intelligent Power Switch that is available in the TO220 package offers an easy upgrade from non-protected devices.

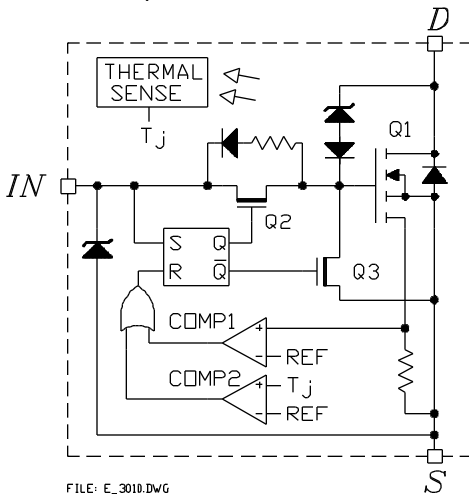

FILE: E\_3010.DWG

**Fig.20 Block Diagram**

### Block Diagram

The zener diode between the input and the source (see figure 20) provides the ESD protection for the input and also limits the applicable voltage to the input to 10V.

The R-S flip-flop memorizes the occurrence of an error condition and controls the Q2 and Q3 switches. The flip-flop can be cleared by holding the input low for the specified minimum duration.

COMP1 and COMP2 comparators are used to compare the over-current and over-temperature signals with the built-in reference. Either comparator can reset the fault flip-flop and turn Q1 off. During fault condition, Q2 disconnects gate of Q1 from the input, Q3 shorts the gate and source of Q1, resulting in rapid turn-off of Q1. The zener diode between the gate and drain of Q1 turns Q1 on, when the drain to source voltage exceeds 55V.

### Switching Characteristics

In the IRSF3010 the control logic and the protection circuits are powered from the input pin. When positive voltage appears at the input pin the R-S flip-flop turns Q2 on and connects the gate of the main device to the input.

The turn-on speed is limited by the channel resistance of Q2 and the gate charge requirements of Q1. The typical switching waveforms at 5V input voltage are shown in figure 21. Using higher input voltage will improve the turn-on time but it does not affect the turn-off switching speed.

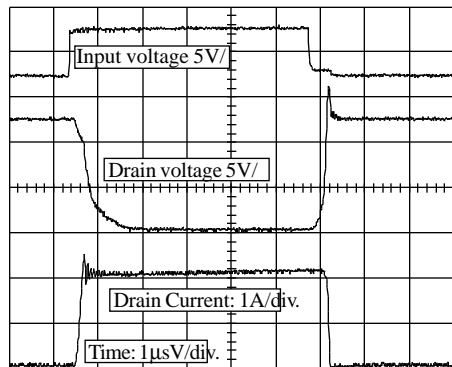

**Fig.21 Waveforms switching clamped inductive load using 5V input voltage**

The typical waveforms at 7V input voltage are shown in figure 22. In typical switching applications, below 40kHz, the difference in switching losses between the IRSF3010 and the same size standard MOSFET is negligible.

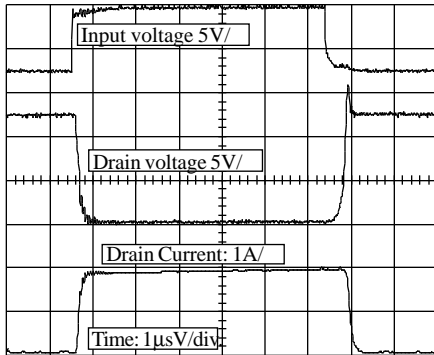

**Fig. 22** Switching waveforms with 7V Input voltage

### Over-current Protection

When the drain current exceeds the preset limit the protection circuit resets the internal flip-flop and turns Q1 off. The normal operation can be restored by holding the input voltage below the specified threshold level (approx. 1.3V) for the specified minimum  $t_{reset}$  time.

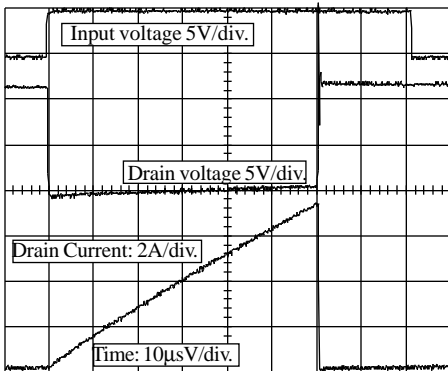
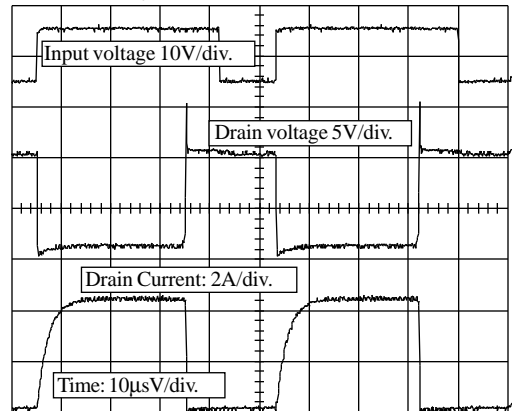

**Fig. 23** Waveforms at over-current shut-down

The typical waveforms at over-current shut-down are shown in figure 23. After turn-on the current in the inductor at the drain starts ramping up. At about 15A the over-current protection shuts down the device.

### Over-temperature Protection

Figure 24 illustrates the operation of the over-temperature protection. The IRSF3010 switches a 1Ω resistive load to a 12V power supply. When the thermal balance is established the junction temperature is limited on pulse by pulse basis.



**Fig. 24** Over-temperature shut-down

### Over-voltage Protection

When the drain to source voltage exceeds 55V the zener diode between gate and drain turns the IRSF3010 on, before the breakdown voltage of the drain-source diode is reached. This greatly enhances the energy the device can withstand safely during turn-off of inductive loads compared to avalanche breakdown. Thus the device can be used for fast de-energization of inductive loads. The absorbed energy is limited only by the maximum junction temperature.