

# Technische Information / Technical Information

IGBT-Module  
IGBT-Modules

## FP75R12KE3

eupec

### Elektrische Eigenschaften / Electrical properties

#### Höchstzulässige Werte / Maximum rated values

##### Diode Gleichrichter/ Diode Rectifier

Periodische Rückw. Spitzensperrspannung repetitive peak reverse voltage	$T_{vj} = 25^{\circ}\text{C}$	$V_{RRM}$	1600	V
Gleichrichter Ausgang Grenzeffektivstrom maximum RMS current at Rectifier output	$T_C = 80^{\circ}\text{C}$	$I_{RMSmax}$	115	A
Durchlaßstrom Grenzeffektivwert proChip Forward current RMS maximum per Chip	$T_C = 80^{\circ}\text{C}$	$I_{FRMSM}$	80	A
Stoßstrom Grenzwert surge forward current	$t_p = 10\text{ ms}, T_{vj} = 25^{\circ}\text{C}$ $t_p = 10\text{ ms}, T_{vj} = 150^{\circ}\text{C}$	$I_{FSM}$	500	A
			400	A
Grenzlastintegral $I^2t$ - value	$t_p = 10\text{ ms}, T_{vj} = 25^{\circ}\text{C}$ $t_p = 10\text{ ms}, T_{vj} = 150^{\circ}\text{C}$	$I^2t$	1250	$\text{A}^2\text{s}$
			800	$\text{A}^2\text{s}$

##### Transistor Wechselrichter/ Transistor Inverter

Kollektor-Emitter-Sperrspannung collector-emitter voltage	$T_{vj} = 25^{\circ}\text{C}$	$V_{CES}$	1200	V
Kollektor-Dauergleichstrom DC-collector current	$T_C = 80^{\circ}\text{C}$ $T_C = 25^{\circ}\text{C}$	$I_{C,nom.}$ $I_C$	75	A
			105	A
Periodischer Kollektor Spitzenstrom repetitive peak collector current	$t_p = 1\text{ ms}, T_C = 80^{\circ}\text{C}$	$I_{CRM}$	150	A
Gesamt-Verlustleistung total power dissipation	$T_C = 25^{\circ}\text{C}$	$P_{tot}$	350	W
Gate-Emitter-Spitzenspannung gate-emitter peak voltage		$V_{GES}$	+/- 20V	V

##### Diode Wechselrichter/ Diode Inverter

Dauergleichstrom DC forward current		$I_F$	75	A
Periodischer Spitzenstrom repetitive peak forw. current	$t_p = 1\text{ ms}$	$I_{FRM}$	150	A
Grenzlastintegral $I^2t$ - value	$V_R = 0\text{V}, t_p = 10\text{ms}, T_{vj} = 125^{\circ}\text{C}$	$I^2t$	1.190	$\text{A}^2\text{s}$

##### Transistor Brems-Chopper/ Transistor Brake-Chopper

Kollektor-Emitter-Sperrspannung collector-emitter voltage	$T_{vj} = 25^{\circ}\text{C}$	$V_{CES}$	1200	V
Kollektor-Dauergleichstrom DC-collector current	$T_C = 80^{\circ}\text{C}$ $T_C = 25^{\circ}\text{C}$	$I_{C,nom.}$ $I_C$	40	A
			55	A
Periodischer Kollektor Spitzenstrom repetitive peak collector current	$t_p = 1\text{ ms}, T_C = 80^{\circ}\text{C}$	$I_{CRM}$	80	A
Gesamt-Verlustleistung total power dissipation	$T_C = 25^{\circ}\text{C}$	$P_{tot}$	200	W
Gate-Emitter-Spitzenspannung gate-emitter peak voltage		$V_{GES}$	+/- 20V	V

##### Diode Brems-Chopper/ Diode Brake-Chopper

Dauergleichstrom DC forward current		$I_F$	25	A
Periodischer Spitzenstrom repetitive peak forw. current	$t_p = 1\text{ ms}$	$I_{FRM}$	50	A

prepared by: Andreas Schulz	date of publication:23.04.2002
approved by: Robert Severin	revision: 2

# Technische Information / Technical Information

eupec

IGBT-Module  
IGBT-Modules

## FP75R12KE3

### Modul Isolation/ Module Isolation

Isolations-Prüfspannung insulation test voltage	RMS, f = 50 Hz, t = 1 min. NTC connected to Baseplate	V <sub>ISOL</sub>	2,5	kV
--	--	-------------------	-----	----

### Elektrische Eigenschaften / Electrical properties

#### Charakteristische Werte / Characteristic values

##### Diode Gleichrichter/ Diode Rectifier

			min.	typ.	max.	
Durchlaßspannung forward voltage	T <sub>vj</sub> = 150°C, I <sub>F</sub> = 75 A	V <sub>F</sub>	-	1,15	-	V
Schleusenspannung threshold voltage	T <sub>vj</sub> = 150°C	V <sub>(TO)</sub>	-	-	0,8	V
Ersatzwiderstand slope resistance	T <sub>vj</sub> = 150°C	r <sub>T</sub>	-	-	6,5	mΩ
Sperrstrom reverse current	T <sub>vj</sub> = 150°C, V <sub>R</sub> = 1600 V	I <sub>R</sub>	-	3	-	mA
Modul Leitungswiderstand, Anschlüsse-Chip lead resistance, terminals-chip	T <sub>C</sub> = 25°C	R <sub>AA+CC</sub>	-	4	-	mΩ

##### Transistor Wechselrichter/ Transistor Inverter

			min.	typ.	max.	
Kollektor-Emitter Sättigungsspannung collector-emitter saturation voltage	V <sub>GE</sub> = 15V, T <sub>vj</sub> = 25°C, I <sub>C</sub> = 75 A	V <sub>CE sat</sub>	-	1,7	2,15	V
	V <sub>GE</sub> = 15V, T <sub>vj</sub> = 125°C, I <sub>C</sub> = 75 A		-	2	-	V
Gate-Schwellenspannung gate threshold voltage	V <sub>CE</sub> = V <sub>GE</sub> , T <sub>vj</sub> = 25°C, I <sub>C</sub> = 3,0 mA	V <sub>GE(TO)</sub>	5,0	5,8	6,5	V
Eingangskapazität input capacitance	f = 1MHz, T <sub>vj</sub> = 25°C V <sub>CE</sub> = 25 V, V <sub>GE</sub> = 0 V	C <sub>ies</sub>	-	5,3	-	nF
Kollektor-Emitter Reststrom collector-emitter cut off current	V <sub>GE</sub> = 0V, T <sub>vj</sub> = 25°C, V <sub>CE</sub> = 1200 V	I <sub>CES</sub>	-	-	5	mA
Gate-Emitter Reststrom gate-emitter leakage current	V <sub>CE</sub> = 0V, V <sub>GE</sub> = 20V, T <sub>vj</sub> = 25°C	I <sub>GES</sub>	-	-	400	nA
Einschaltverzögerungszeit (ind. Last) turn on delay time (inductive load)	I <sub>C</sub> = I <sub>Nenn</sub> , V <sub>CC</sub> = 600 V	t <sub>d,on</sub>	-	260	-	ns
	V <sub>GE</sub> = ±15V, T <sub>vj</sub> = 25°C, R <sub>G</sub> = 5 Ohm					
	V <sub>GE</sub> = ±15V, T <sub>vj</sub> = 125°C, R <sub>G</sub> = 5 Ohm					
Anstiegszeit (induktive Last) rise time (inductive load)	I <sub>C</sub> = I <sub>Nenn</sub> , V <sub>CC</sub> = 600 V	t <sub>r</sub>	-	30	-	ns
	V <sub>GE</sub> = ±15V, T <sub>vj</sub> = 25°C, R <sub>G</sub> = 5 Ohm					
	V <sub>GE</sub> = ±15V, T <sub>vj</sub> = 125°C, R <sub>G</sub> = 5 Ohm					
Abschaltverzögerungszeit (ind. Last) turn off delay time (inductive load)	I <sub>C</sub> = I <sub>Nenn</sub> , V <sub>CC</sub> = 600 V	t <sub>d,off</sub>	-	420	-	ns
	V <sub>GE</sub> = ±15V, T <sub>vj</sub> = 25°C, R <sub>G</sub> = 5 Ohm					
	V <sub>GE</sub> = ±15V, T <sub>vj</sub> = 125°C, R <sub>G</sub> = 5 Ohm					
Fallzeit (induktive Last) fall time (inductive load)	I <sub>C</sub> = I <sub>Nenn</sub> , V <sub>CC</sub> = 600 V	t <sub>f</sub>	-	65	-	ns
	V <sub>GE</sub> = ±15V, T <sub>vj</sub> = 25°C, R <sub>G</sub> = 5 Ohm					
	V <sub>GE</sub> = ±15V, T <sub>vj</sub> = 125°C, R <sub>G</sub> = 5 Ohm					
Einschaltverlustenergie pro Puls turn-on energy loss per pulse	I <sub>C</sub> = I <sub>Nenn</sub> , V <sub>CC</sub> = 600 V	E <sub>on</sub>	-	9,4	-	mWs
	V <sub>GE</sub> = ±15V, T <sub>vj</sub> = 125°C, R <sub>G</sub> = 5 Ohm Lσ = 45 nH					
Abschaltverlustenergie pro Puls turn-off energy loss per pulse	I <sub>C</sub> = I <sub>Nenn</sub> , V <sub>CC</sub> = 600 V	E <sub>off</sub>	-	9,4	-	mWs
	V <sub>GE</sub> = ±15V, T <sub>vj</sub> = 125°C, R <sub>G</sub> = 5 Ohm Lσ = 45 nH					
Kurzschlußverhalten SC Data	t <sub>p</sub> ≤ 10μs, V <sub>GE</sub> ≤ 15V, R <sub>G</sub> = 5 Ohm T <sub>vj</sub> ≤ 125°C, V <sub>CC</sub> = 720 V	I <sub>SC</sub>	-	300	-	A

**Elektrische Eigenschaften / Electrical properties**

**Charakteristische Werte / Characteristic values**

		min.	typ.	max.		
Modulinduktivität stray inductance module		$L_{\sigma CE}$	-	-	60	nH
Modul Leitungswiderstand, Anschlüsse-Chip lead resistance, terminals-chip	$T_C = 25^\circ C$	$R_{CC+EE}$	-	7	-	m $\Omega$
<b>Diode Wechselrichter/ Diode Inverter</b>			<b>min.</b>	<b>typ.</b>	<b>max.</b>	
Durchlaßspannung forward voltage	$V_{GE} = 0V, T_{vj} = 25^\circ C, I_F = 75 A$ $V_{GE} = 0V, T_{vj} = 125^\circ C, I_F = 75 A$	$V_F$	-	1,65	2,15	V
Rückstromspitze peak reverse recovery current	$I_F = I_{Nenn}, -di_F/dt = 2000 A/\mu s$ $V_{GE} = -10V, T_{vj} = 25^\circ C, V_R = 600 V$ $V_{GE} = -10V, T_{vj} = 125^\circ C, V_R = 600 V$	$I_{RM}$	-	80	-	A
Sperrverzögerungsladung recovered charge	$I_F = I_{Nenn}, -di_F/dt = 2000 A/\mu s$ $V_{GE} = -10V, T_{vj} = 25^\circ C, V_R = 600 V$ $V_{GE} = -10V, T_{vj} = 125^\circ C, V_R = 600 V$	$Q_r$	-	9,3	-	$\mu As$
Abschaltenergie pro Puls reverse recovery energy	$I_F = I_{Nenn}, -di_F/dt = 2000 A/\mu s$ $V_{GE} = -10V, T_{vj} = 25^\circ C, V_R = 600 V$ $V_{GE} = -10V, T_{vj} = 125^\circ C, V_R = 600 V$	$E_{rec}$	-	3,2	-	mWs
<b>Transistor Brems-Chopper/ Transistor Brake-Chopper</b>			<b>min.</b>	<b>typ.</b>	<b>max.</b>	
Kollektor-Emitter Sättigungsspannung collector-emitter saturation voltage	$V_{GE} = 15V, T_{vj} = 25^\circ C, I_C = 40 A$ $V_{GE} = 15V, T_{vj} = 125^\circ C, I_C = 40 A$	$V_{CE sat}$	-	1,8	2,3	V
Gate-Schwellenspannung gate threshold voltage	$V_{CE} = V_{GE}, T_{vj} = 25^\circ C, I_C = 1,5 mA$	$V_{GE(TO)}$	5,0	5,8	6,5	V
Eingangskapazität input capacitance	$f = 1MHz, T_{vj} = 25^\circ C$ $V_{CE} = 25 V, V_{GE} = 0 V$	$C_{ies}$	-	2,5	-	nF
Kollektor-Emitter Reststrom collector-emitter cut off current	$V_{GE} = 0V, T_{vj} = 25^\circ C, V_{CE} = 1200 V$	$I_{CES}$	-	5,0	500	mA
Gate-Emitter Reststrom gate-emitter leakage current	$V_{CE} = 0V, V_{GE} = 20V, T_{vj} = 25^\circ C$	$I_{GES}$	-	-	400	nA
Schaltverluste und -bedingungen Switching losses and conditions	siehe Wechselrichter in Dbl FP40R12KE3 see inverter in datasheet FP40R12KE3					
<b>Diode Brems-Chopper/ Diode Brake-Chopper</b>			<b>min.</b>	<b>typ.</b>	<b>max.</b>	
Durchlaßspannung forward voltage	$T_{vj} = 25^\circ C, I_F = 40 A$ $T_{vj} = 125^\circ C, I_F = 40 A$	$V_F$	-	1,95	2,5	V
Schaltverluste und -bedingungen Switching losses and conditions	siehe Wechselrichter in Dbl FP25R12KE3 see inverter in datasheet FP25R12KE3					
<b>NTC-Widerstand/ NTC-Thermistor</b>			<b>min.</b>	<b>typ.</b>	<b>max.</b>	
Nennwiderstand rated resistance	$T_C = 25^\circ C$	$R_{25}$	-	5	-	k $\Omega$
Abweichung von $R_{100}$ deviation of $R_{100}$	$T_C = 100^\circ C, R_{100} = 493 \Omega$	$\Delta R/R$	-5		5	%
Verlustleistung power dissipation	$T_C = 25^\circ C$	$P_{25}$			20	mW
B-Wert B-value	$R_2 = R_1 \exp [B(1/T_2 - 1/T_1)]$	$B_{25/50}$		3375		K

**Thermische Eigenschaften / Thermal properties**

		min.	typ.	max.		
Innerer Wärmewiderstand thermal resistance, junction to case	Glechr. Diode/ Rectif. Diode	$R_{thJC}$	-	-	0,65	K/W
	Trans. Wechsr./ Trans. Inverter		-	-	0,35	K/W
	Diode Wechsr./ Diode Inverter		-	-	0,58	K/W
	Trans. Bremse/ Trans. Brake		-	-	0,6	K/W
	Diode Bremse/ Diode Brake		-	-	1,2	K/W
Übergangs-Wärmewiderstand thermal resistance, case to heatsink	Glechr. Diode/ Rectif. Diode	$R_{thCK}$	-	0,04	-	K/W
	Trans. Wechsr./ Trans. Inverter		-	0,02	-	K/W
	Diode Wechsr./ Diode Inverter		-	0,04	-	K/W
Höchstzulässige Sperrschichttemperatur maximum junction temperature		$T_{vj}$	-	-	150	°C
Betriebstemperatur operation temperature		$T_{op}$	-40	-	125	°C
Lagertemperatur storage temperature		$T_{stg}$	-40	-	125	°C

**Mechanische Eigenschaften / Mechanical properties**

Innere Isolation internal insulation				$Al_2O_3$	
CTI comperative tracking index				225	
Anzugsdrehmoment f. mech. Befestigung mounting torque	Schraube M 5 screw M 5	M	3	-	6 Nm
Gewicht weight		G		300	g
Luftstrecke clearance	Pin-Erde Pin-GND			7,5	mm
Kriechstrecke creeping distance	Pin-Erde Pin-GND			10	mm

**Transiente Thermische Eigenschaften / Transient Thermal properties**

	IGBT-Wechselrichter IGBT-Inverter		Diode-Wechselrichter Diode-Inverter	
	$r_i$ [K/W]	$\tau_i$ [s]	$r_i$ [K/W]	$\tau_i$ [s]
1	3,949E-02	2,345E-03	5,906E-02	3,333E-03
2	6,139E-02	2,820E-01	3,815E-01	3,429E-02
3	1,580E-01	2,820E-02	1,099E-01	1,294E-01
4	8,884E-02	1,128E-01	3,480E-02	7,662E-01

# FP75R12KE3

**Ausgangskennlinienfeld Wechselr. (typisch)**

**$I_C = f(V_{CE})$**

**Output characteristic Inverter (typical)**

**$V_{GE} = 15\text{ V}$**

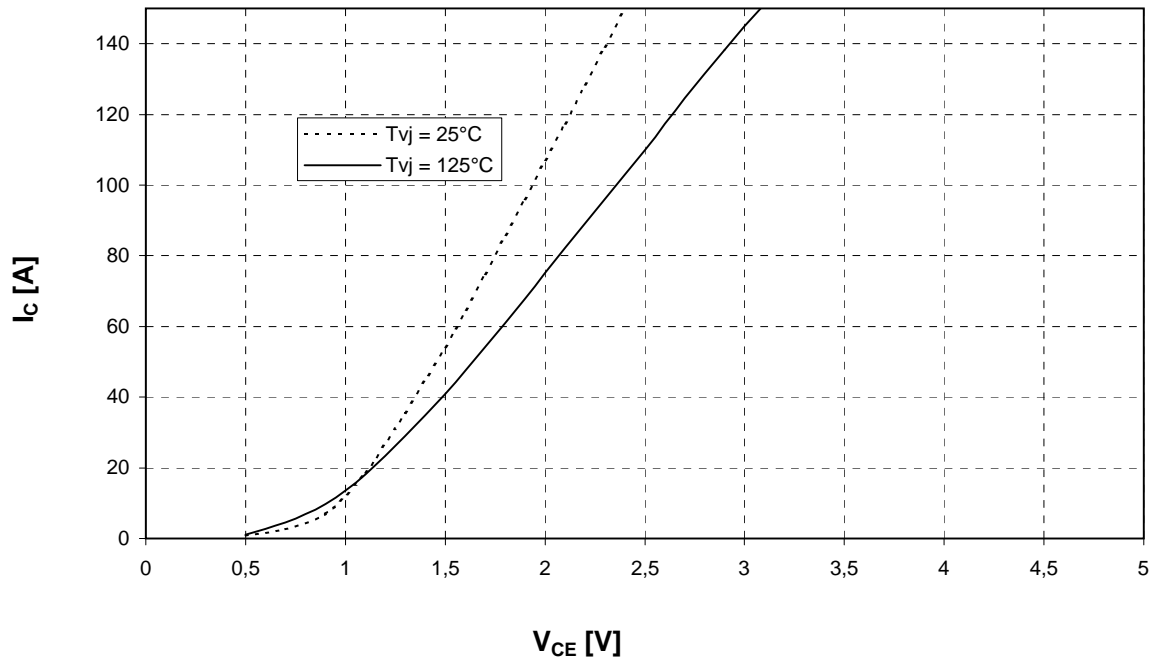

**Ausgangskennlinienfeld Wechselr. (typisch)**

**$I_C = f(V_{CE})$**

**Output characteristic Inverter (typical)**

**$T_{vj} = 125^\circ\text{C}$**

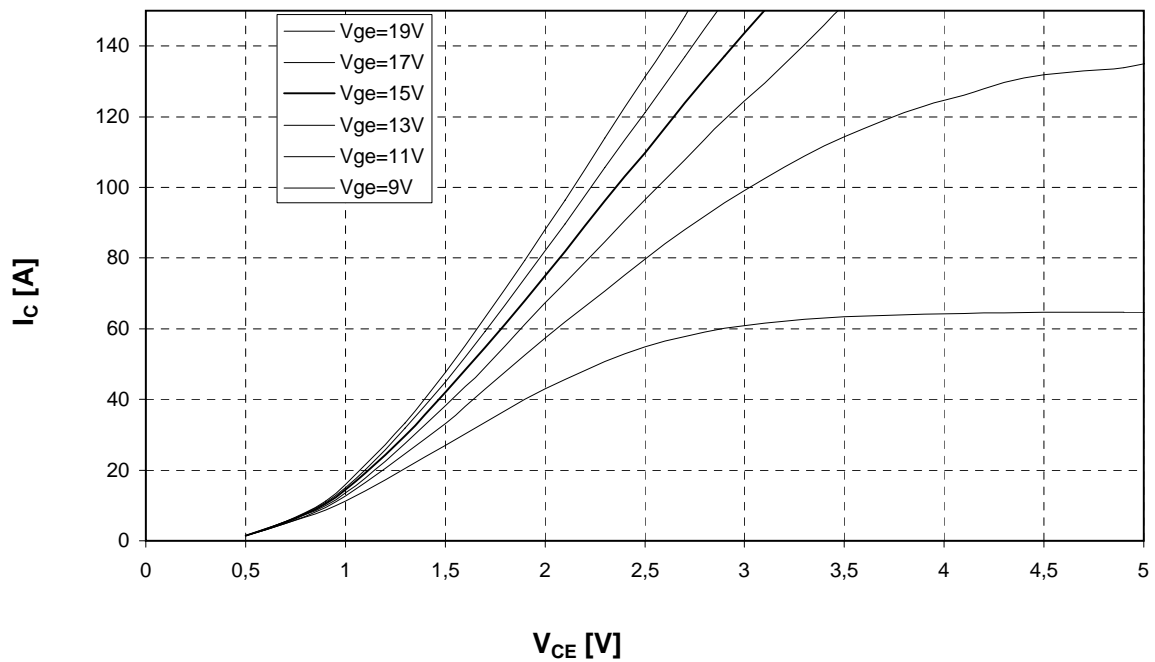

Übertragungscharakteristik Wechselr. (typisch)

$I_C = f(V_{GE})$

Transfer characteristic Inverter (typical)

$V_{CE} = 20\text{ V}$

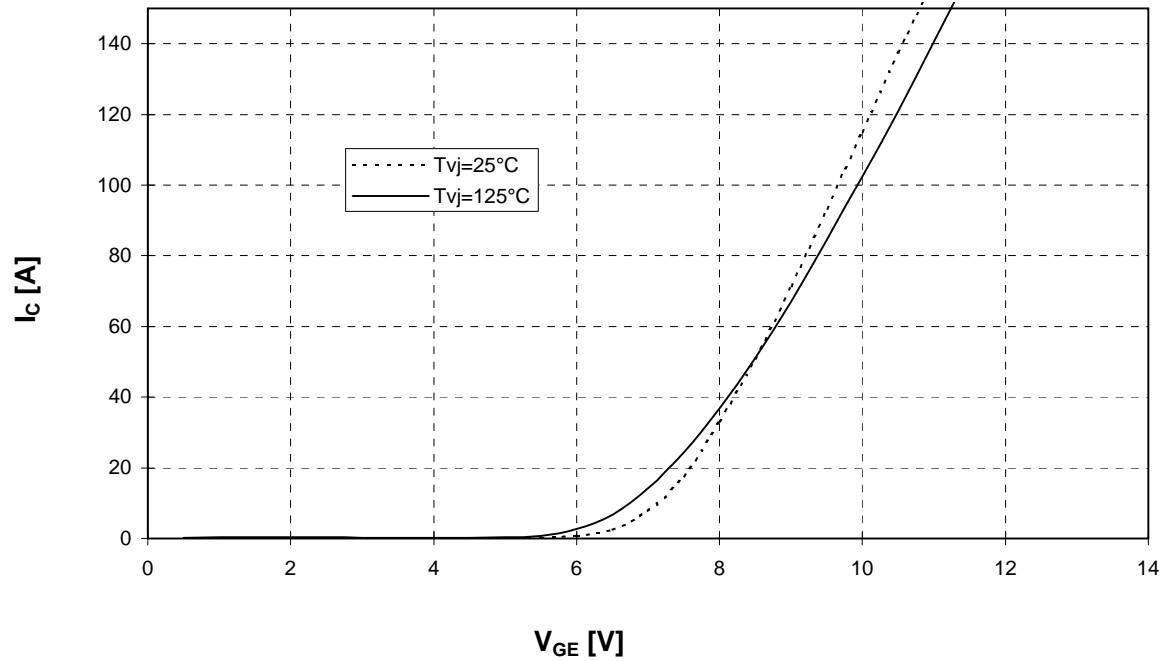

Durchlaßkennlinie der Freilaufdiode Wechselr. (typisch)

$I_F = f(V_F)$

Forward characteristic of FWD Inverter (typical)

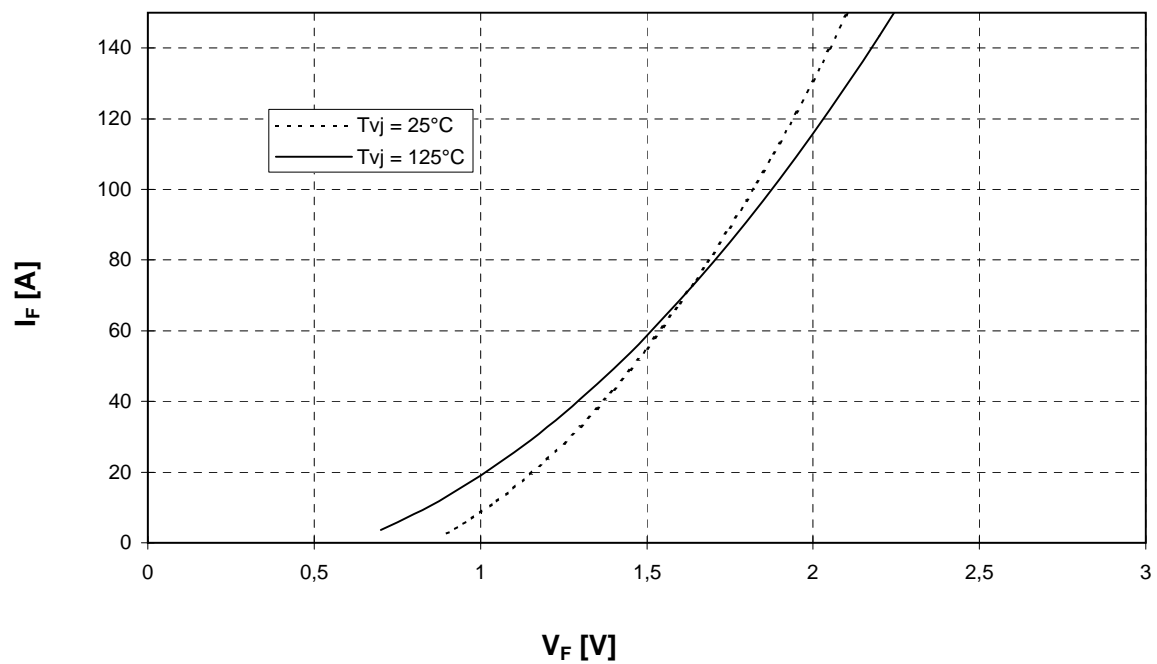

Schaltverluste Wechselr. (typisch)  $E_{on} = f(I_C), E_{off} = f(I_C), E_{rec} = f(I_C)$   $V_{CC} = 600\text{ V}$   
 Switching losses Inverter (typical)  $T_j = 125^\circ\text{C}, V_{GE} = \pm 15\text{ V}, R_{Gon} = R_{Goff} = 4,7\text{ Ohm}$

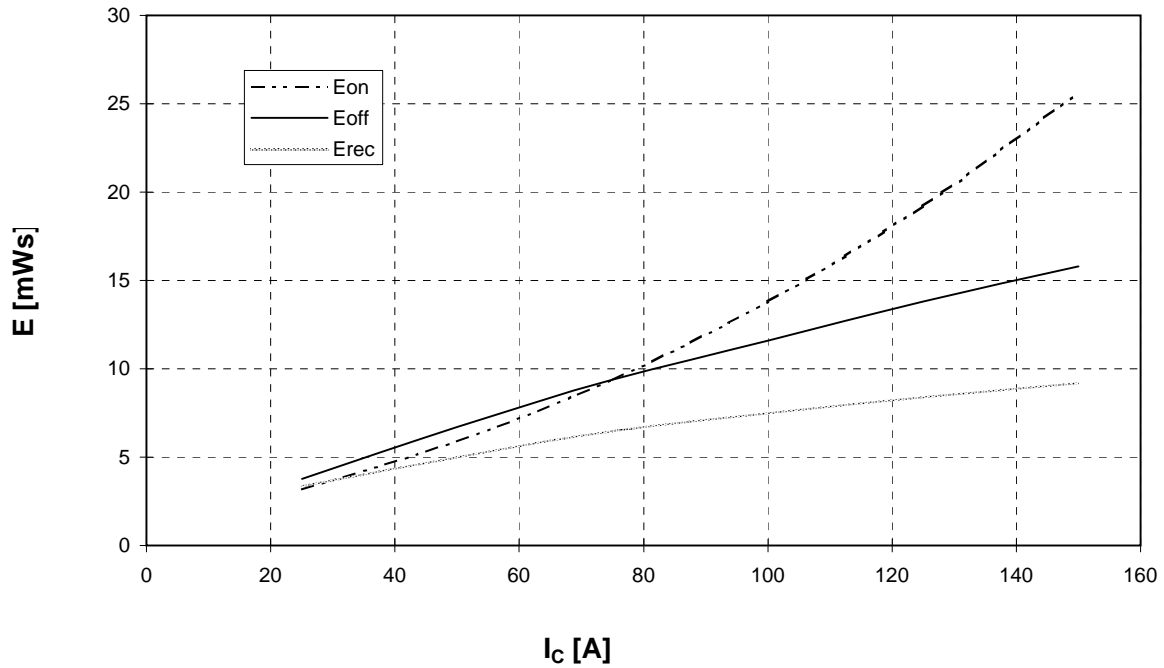

Schaltverluste Wechselr. (typisch)  $E_{on} = f(R_G), E_{off} = f(R_G), E_{rec} = f(R_G)$   
 Switching losses Inverter (typical)  $T_j = 125^\circ\text{C}, V_{GE} = \pm 15\text{ V}, I_C = I_{nenn}, V_{CC} = 600\text{ V}$

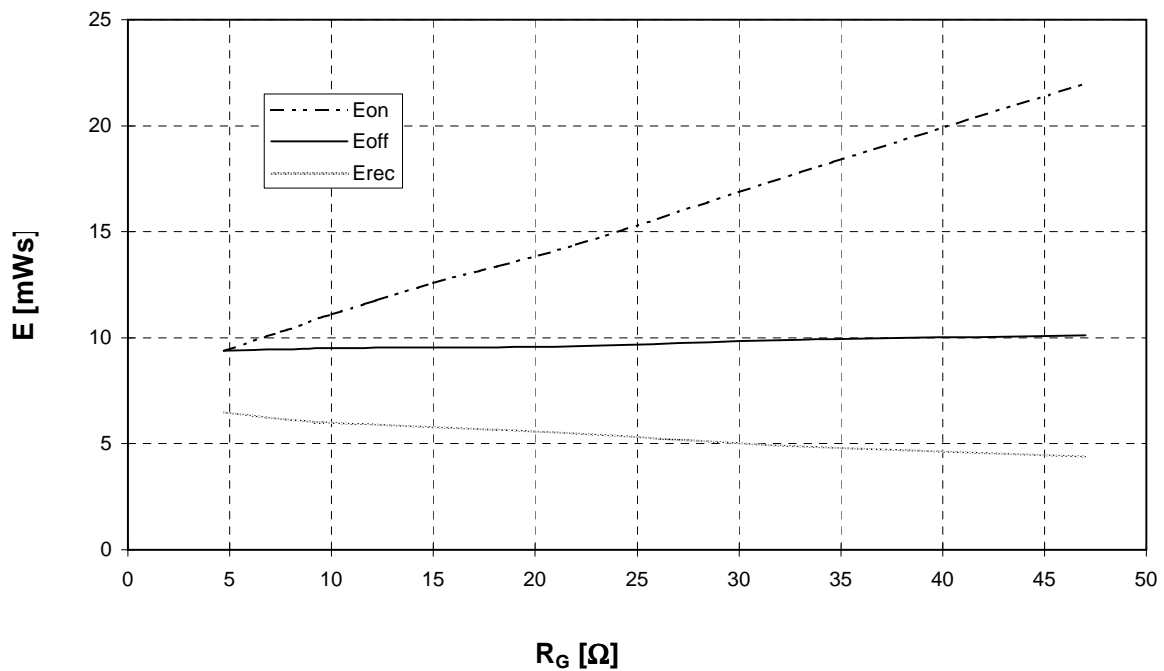

**Transienter Wärmewiderstand Wechselr.  
Transient thermal impedance Inverter**

$Z_{thJC} = f(t)$

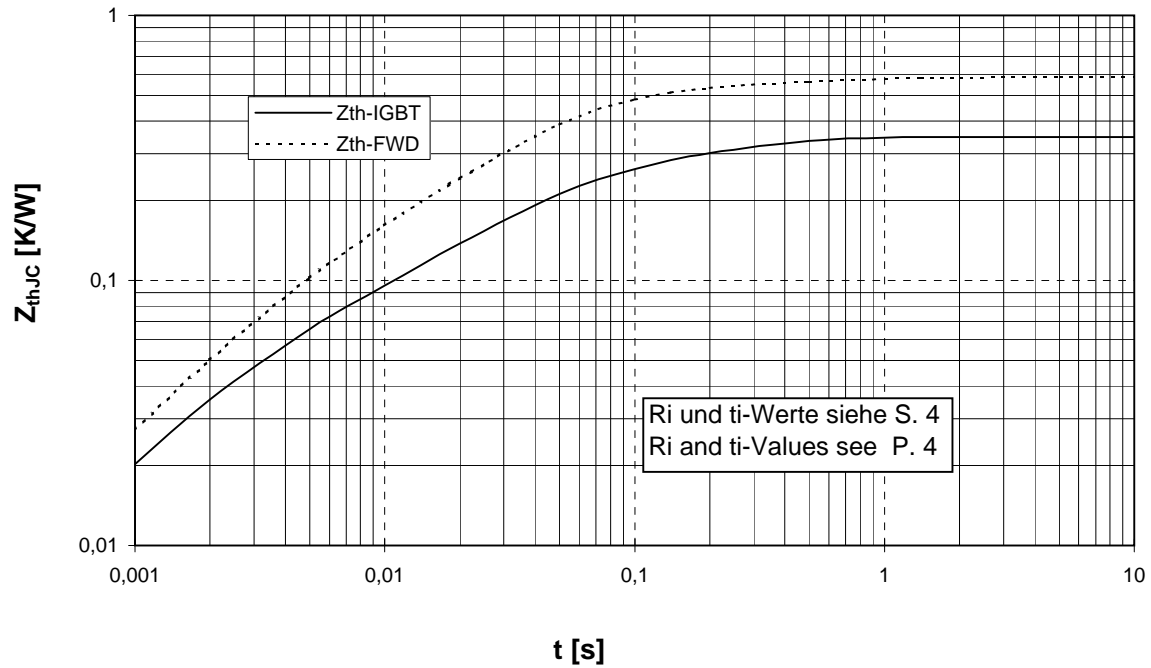

**Sicherer Arbeitsbereich IGBT-Wechselr. (RBSOA)  
Reverse bias safe operating area (RBSOA)**

$V_{GE} = 15V, T_j = 125^\circ C$

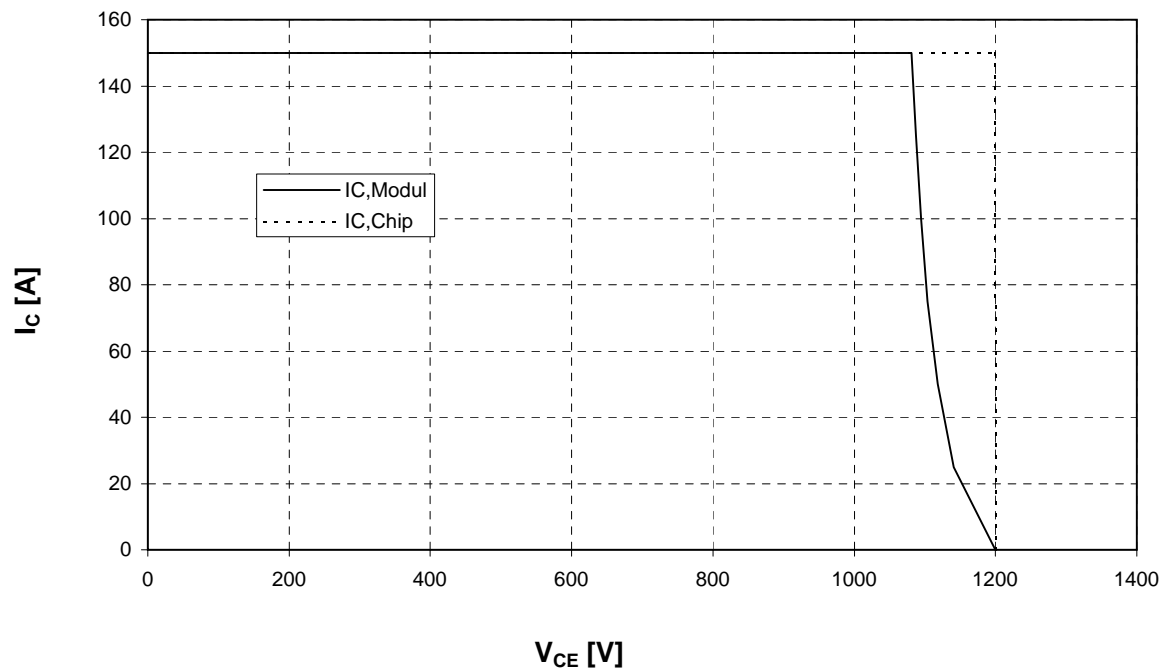



Ausgangskennlinienfeld Brems-Chopper-IGBT (typisch)

$I_C = f(V_{CE})$

Output characteristic brake-chopper-IGBT (typical)

$V_{GE} = 15 \text{ V}$

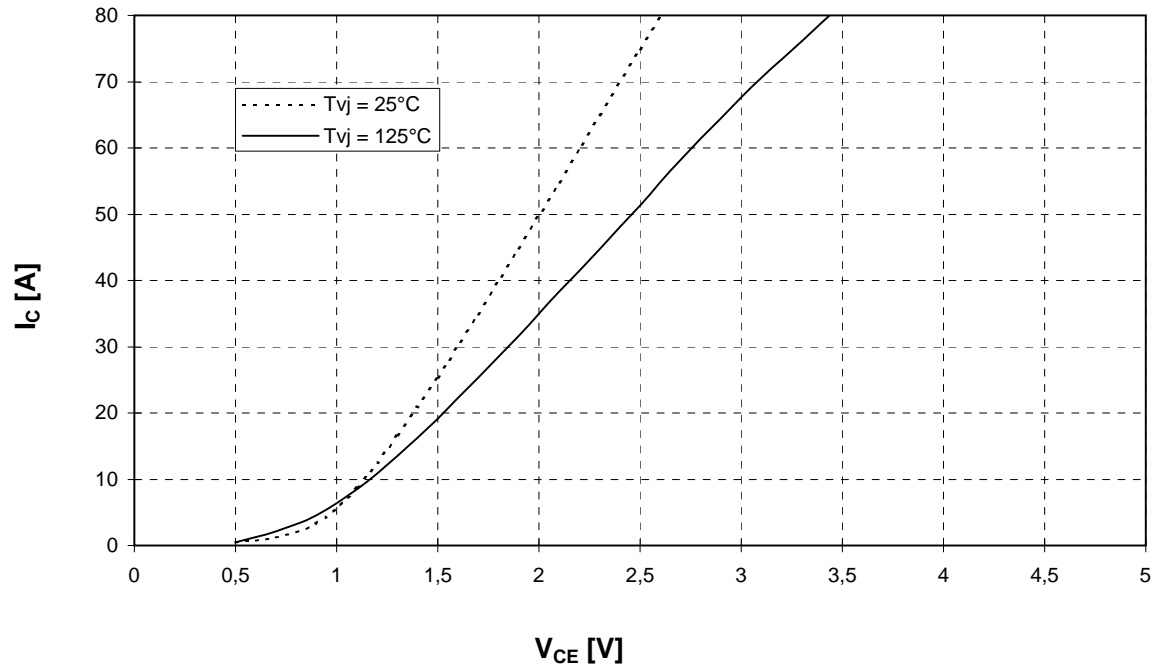

Durchlaßkennlinie der Brems-Chopper-Diode (typisch)  $I_F = f(V_F)$

Forward characteristic of brake-chopper-FWD (typical)

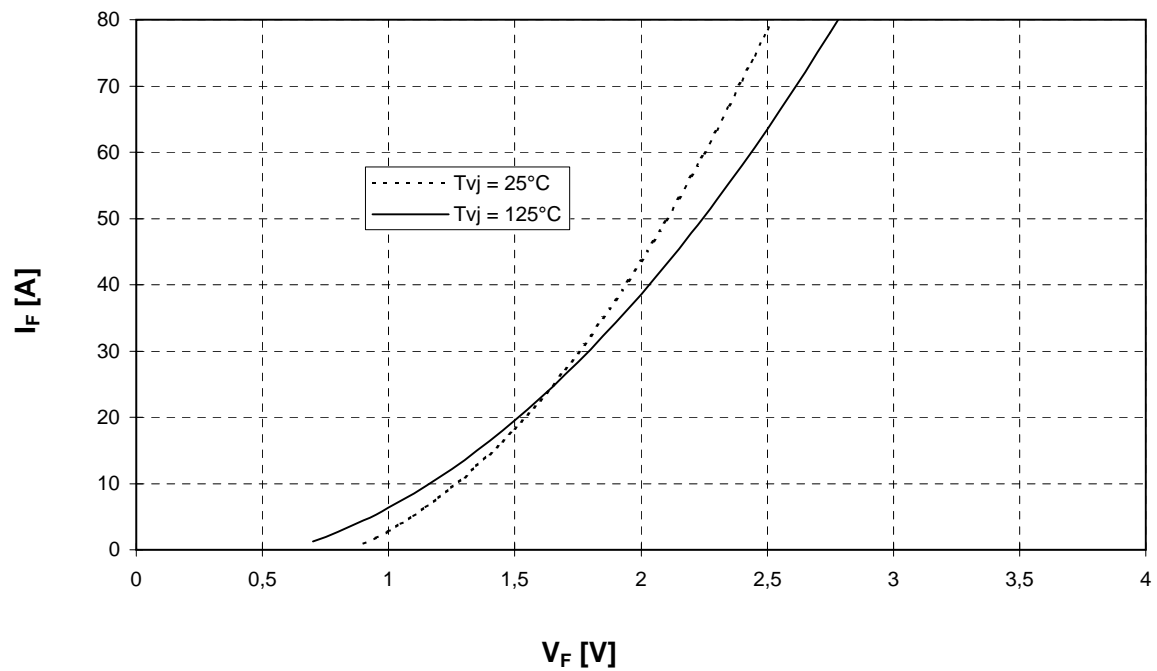

# FP75R12KE3

**Durchlaßkennlinie der Gleichrichterdiode (typisch)  $I_F = f(V_F)$**   
**Forward characteristic of Rectifier Diode (typical)**

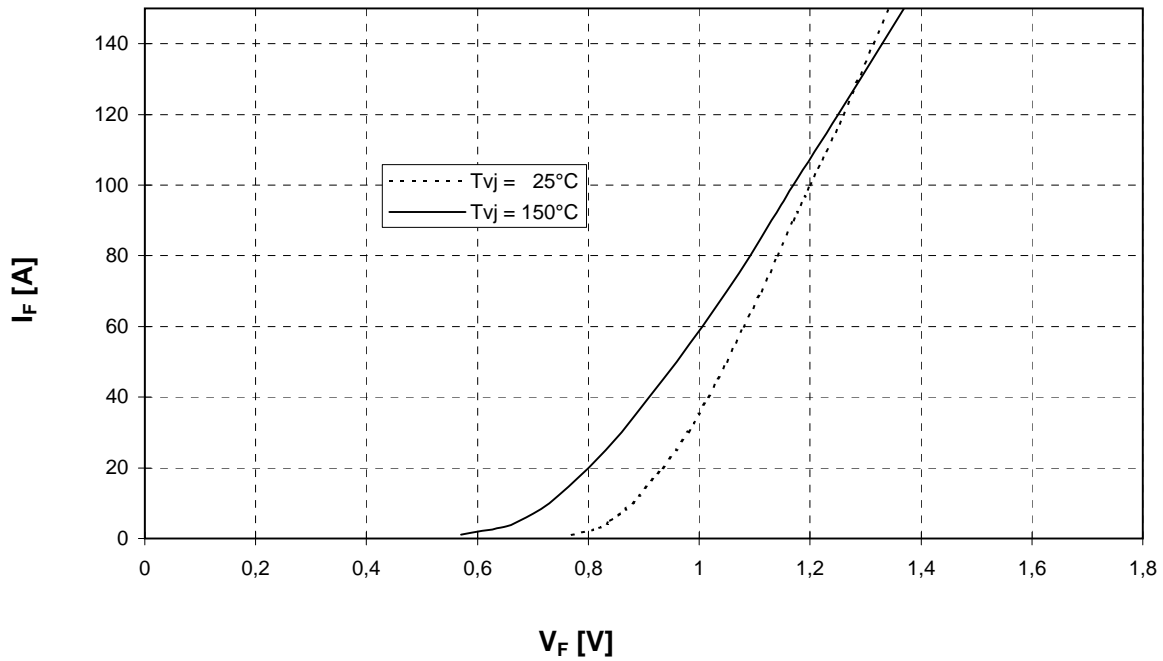

**NTC- Temperaturkennlinie (typisch)  $R = f(T)$**   
**NTC- temperature characteristic (typical)**

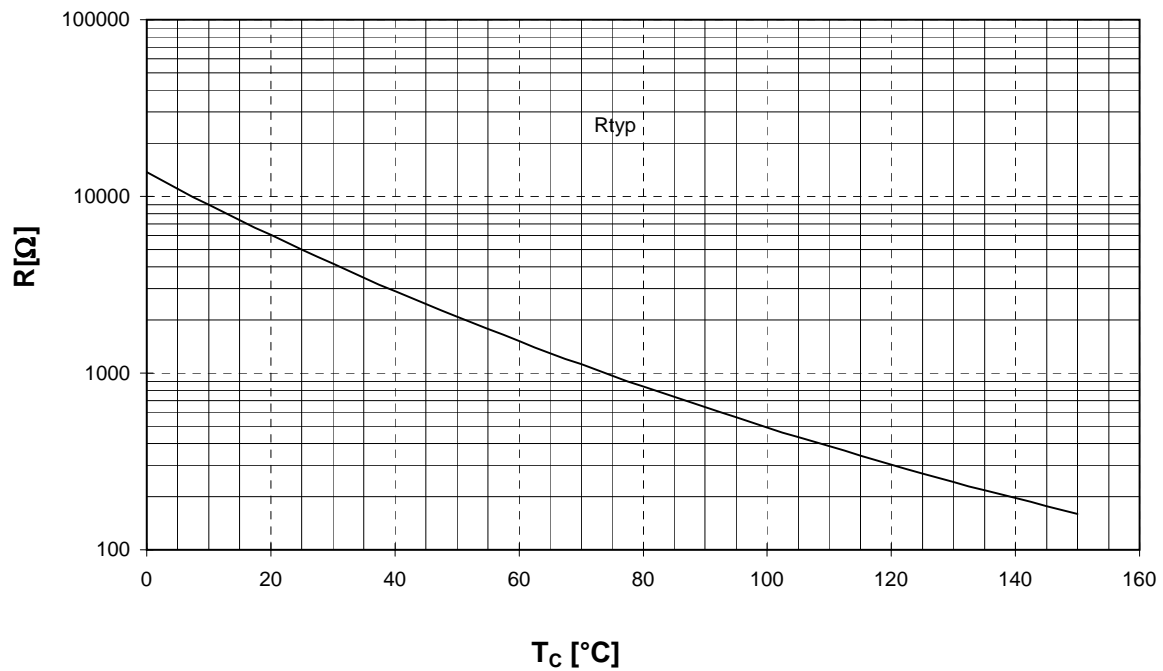

Schaltplan/ Circuit diagram

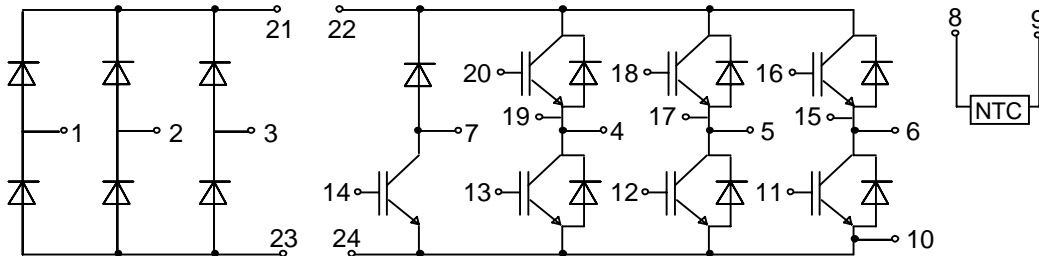

Gehäuseabmessungen/ Package outlines

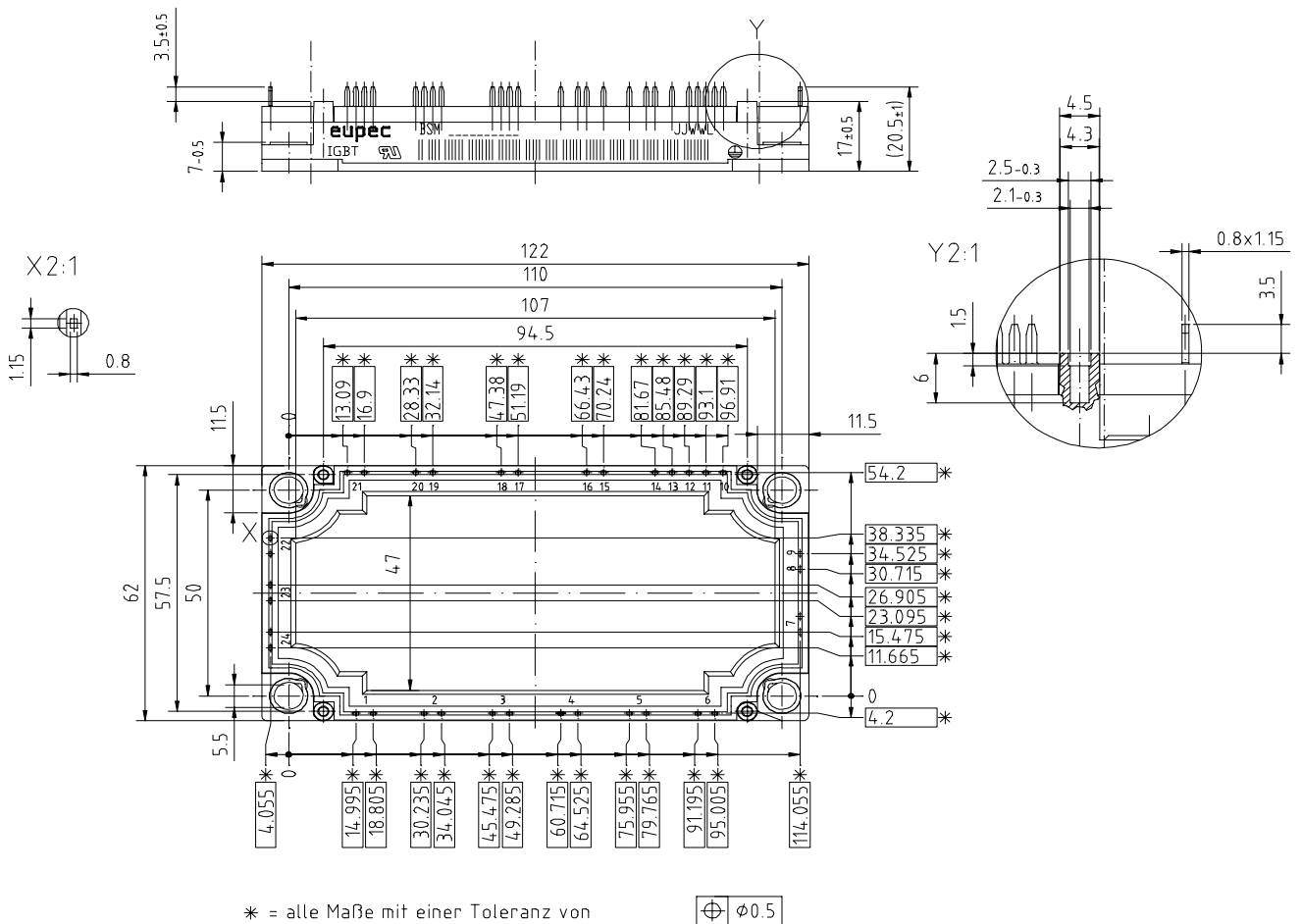

Mit dieser technischen Information werden Halbleiterbauelemente spezifiziert, jedoch keine Eigenschaften zugesichert. Sie gilt in Verbindung mit den zugehörigen Technischen Erläuterungen.

This technical information specifies semiconductor devices but promises no characteristics. It is valid in combination with the belonging technical notes.