

SANYO

No.938B

2SC3042

NPN Triple Diffused Planar Silicon Transistor
FOR SWITCHING REGULATORS

Features

- . High breakdown voltage ($V_{CBO} \geq 500V$)
- . Fast switching speed.
- . Wide ASO.

Absolute Maximum Ratings at $T_a=25^\circ C$

Parameter	Symbol	Value	unit
Collector-to-Base Voltage	V_{CBO}	500	V
Collector-to-Emitter Voltage	V_{CEO}	400	V
Emitter-to-Base Voltage	V_{EBO}	7	V
Collector Current	I_C	12	A
Peak Collector Current	i_{cp}	25	A
PW \leq 300 μ s, Duty Cycle \leq 10%			
Base Current	I_B	4	A
Collector Dissipation	P_C	2.5	W
$T_c=25^\circ C$			
Junction Temperature	T_j	100	$^\circ C$
Storage Temperature	T_{stg}	150	$^\circ C$
		-55 to +150	$^\circ C$

Electrical Characteristics at $T_a=25^\circ C$

Parameter	Symbol	Test Conditions	min	typ	max	unit
Collector Cutoff Current	I_{CBO}	$V_{CB}=400V, I_E=0$			10	μA
Emitter Cutoff Current	I_{EBO}	$V_{EB}=5V, I_C=0$			10	μA
DC Current Gain	$h_{FE}(1)$	$V_{CE}=5V, I_C=1.6A$	15*		50*	
	$h_{FE}(2)$	$V_{CE}=5V, I_C=8A$	8			
C-E Saturation Voltage	$V_{CE(sat)}$	$I_C=8A, I_B=1.6A$			1.0	V
B-E Saturation Voltage	$V_{BE(sat)}$	$I_C=8A, I_B=1.6A$			1.5	V
Gain-Bandwidth Product	f_T	$V_{CE}=10V, I_C=1.6A$		20		MHz
Output Capacitance	c_{ob}	$V_{CB}=10V, f=1MHz$		160		pF
C-B Breakdown Voltage	$V_{(BR)CBO}$	$I_C=1mA, I_E=0$	500			V
C-E Breakdown Voltage	$V_{(BR)CEO}$	$I_C=10mA, R_{BE}=\infty$	400			V
E-B Breakdown Voltage	$V_{(BR)EBO}$	$I_E=1mA, I_C=0$	7			V
C-E Sustain Voltage	$V_{CEO(sus)}$	$I_C=12A, I_B=2.4A, L=50\mu H$	400			V
C-E Sustain Voltage	$V_{CEX(sus)}$	$I_C=12A, I_{B1}=2.4A, L=200\mu H,$ $I_{B2}=-2.4A, \text{clamped}$	400			V
C-E Sustain Voltage	$V_{CEX(sus)}$	$I_C=3A, I_{B1}=0.6A, L=200\mu H,$ $I_{B2}=-0.6A, \text{clamped}$	450			V

*: The $h_{FE}(1)$ of the 2SC3042 is classified as follows. When specifying the $h_{FE}(1)$ rank, specify two ranks or more in principle.

15 L 30	20 M 40	30 N 50
---------	---------	---------

Continued on next page.

Package Dimensions 2022
(unit:mm)

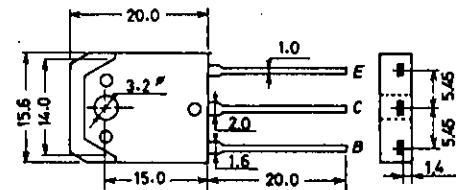

E: Emitter
C: Collector
B: Base

Continued from preceding page.

			min	typ	max	unit
Turn-ON Time	t_{on}	$I_C=10A, I_{B1}=2A, I_{B2}=-2A,$ $R_L=20ohms, V_{CC}=200V$			1.0	μs
Storage Time	t_{stg}	" "			2.5	μs
Fall Time	t_f	" "			1.0	μs

Switching Time Test Circuit

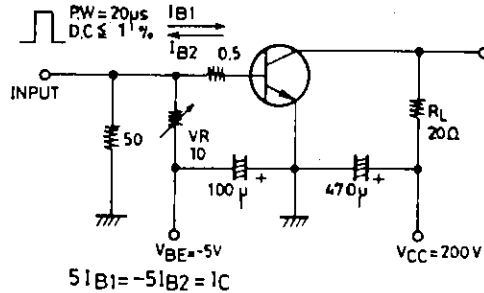

Unit (Resistance : Ω , Capacitance : F)

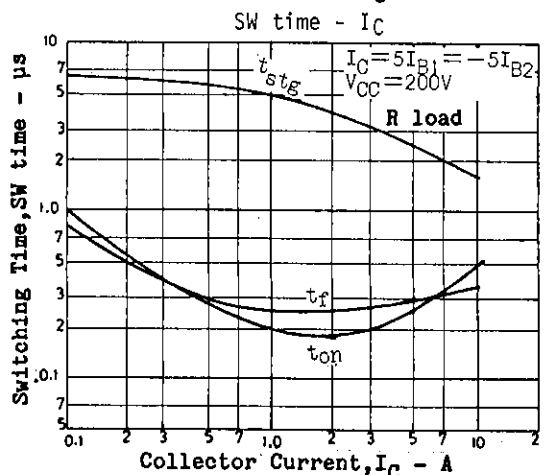
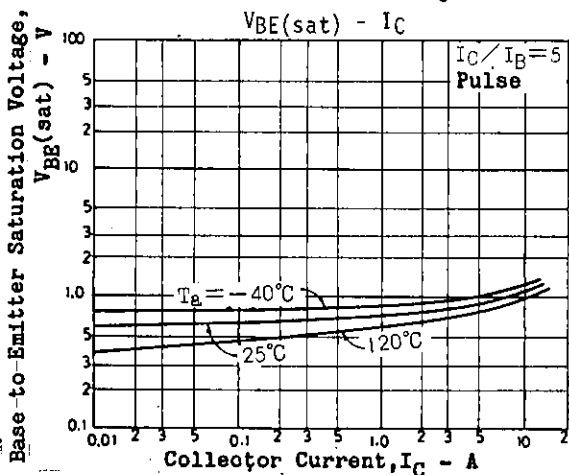
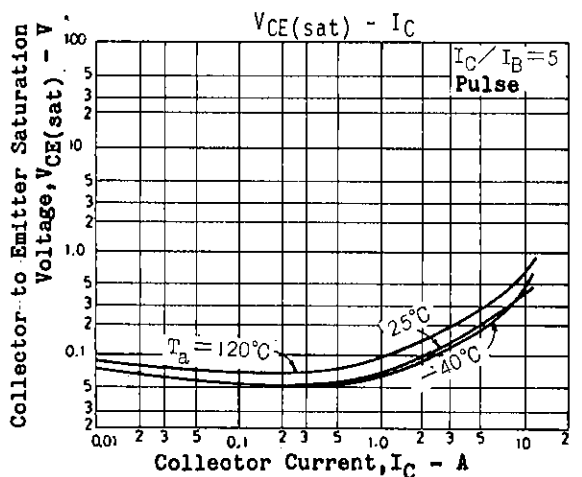
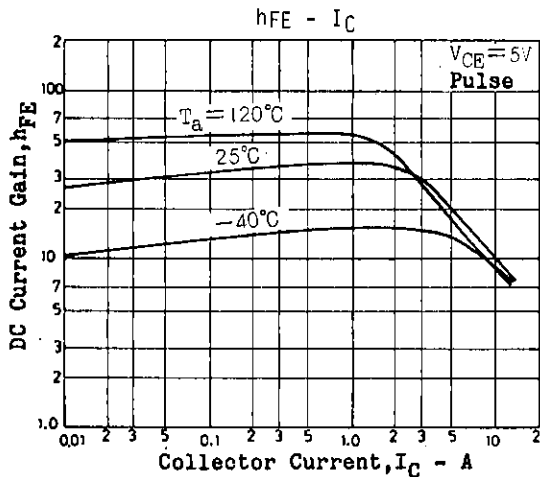
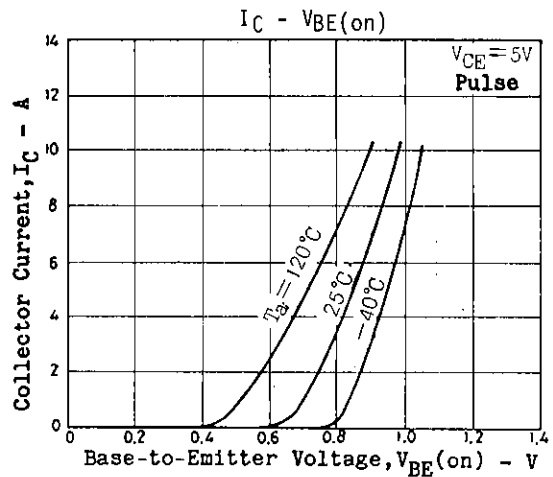
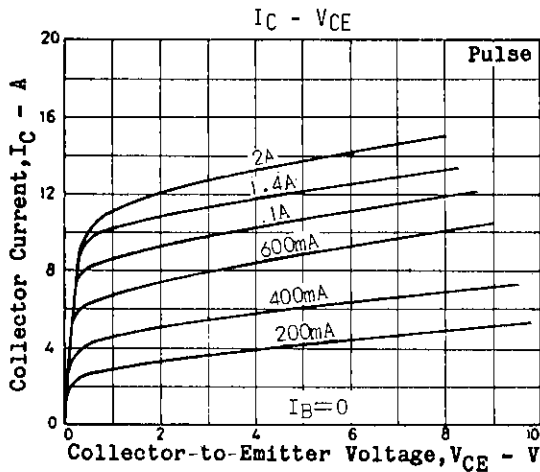

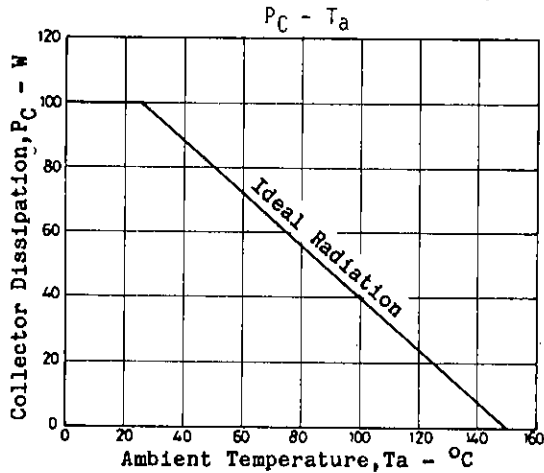
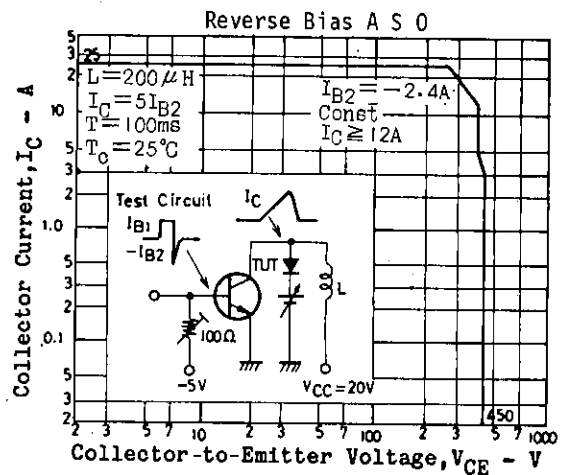
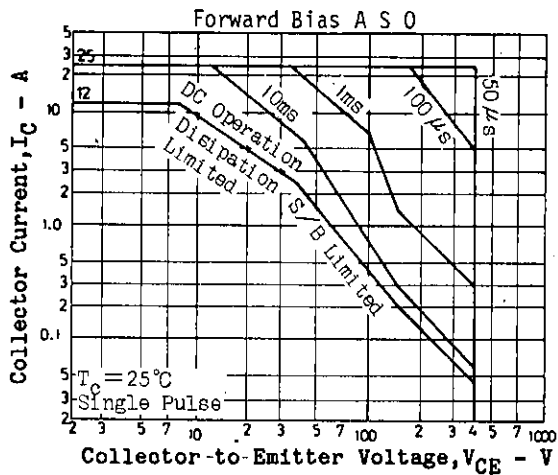

- No products described or contained herein are intended for use in surgical implants, life-support systems, aerospace equipment, nuclear power control systems, vehicles, disaster/crime-prevention equipment and the like, the failure of which may directly or indirectly cause injury, death or property loss.
- Anyone purchasing any products described or contained herein for an above-mentioned use shall:
 - ① Accept full responsibility and indemnify and defend SANYO ELECTRIC CO., LTD., its affiliates, subsidiaries and distributors and all their officers and employees, jointly and severally, against any and all claims and litigation and all damages, cost and expenses associated with such use;
 - ② Not impose any responsibility for any fault or negligence which may be cited in any such claim or litigation on SANYO ELECTRIC CO., LTD., its affiliates, subsidiaries and distributors or any of their officers and employees jointly or severally.
- Information (including circuit diagrams and circuit parameters) herein is for example only; it is not guaranteed for volume production. SANYO believes information herein is accurate and reliable, but no guarantees are made or implied regarding its use or any infringements of intellectual property rights or other rights of third parties.