

# IRF3415S/L

HEXFET® Power MOSFET

- Advanced Process Technology
- Surface Mount (IRF3415S)
- Low-profile through-hole (IRF3415L)
- 175°C Operating Temperature
- Fast Switching
- Fully Avalanche Rated



$V_{DS} = 150V$
$R_{DS(on)} = 0.042\Omega$
$I_D = 43A$

## Description

Fifth Generation HEXFETs from International Rectifier utilize advanced processing techniques to achieve extremely low on-resistance per silicon area. This benefit, combined with the fast switching speed and ruggedized device design that HEXFET Power MOSFETs are well known for, provides the designer with an extremely efficient and reliable device for use in a wide variety of applications.

The D<sup>2</sup>Pak is a surface mount power package capable of accommodating die sizes up to HEX-4. It provides the highest power capability and the lowest possible on-resistance in any existing surface mount package. The D<sup>2</sup>Pak is suitable for high current applications because of its low internal connection resistance and can dissipate up to 2.0W in a typical surface mount application.

The through-hole version (IRF3415L) is available for low-profile applications.



## Absolute Maximum Ratings

	Parameter	Max.	Units
$I_D @ T_C = 25^\circ C$	Continuous Drain Current, $V_{GS} @ 10V$ ⑤	43	A
$I_D @ T_C = 100^\circ C$	Continuous Drain Current, $V_{GS} @ 10V$ ⑤	30	
$I_{DM}$	Pulsed Drain Current ①⑤	150	
$P_D @ T_A = 25^\circ C$	Power Dissipation	3.8	W
$P_D @ T_C = 25^\circ C$	Power Dissipation	200	W
	Linear Derating Factor	1.3	W/°C
$V_{GS}$	Gate-to-Source Voltage	$\pm 20$	V
$E_{AS}$	Single Pulse Avalanche Energy②⑤	590	mJ
$I_{AR}$	Avalanche Current①	22	A
$E_{AR}$	Repetitive Avalanche Energy①	20	mJ
dv/dt	Peak Diode Recovery dv/dt ③⑤	5.0	V/ns
$T_J$	Operating Junction and	-55 to + 175	°C
$T_{STG}$	Storage Temperature Range		
	Soldering Temperature, for 10 seconds	300 (1.6mm from case )	

## Thermal Resistance

	Parameter	Typ.	Max.	Units
$R_{\theta JC}$	Junction-to-Case	—	0.75	°C/W
$R_{\theta JA}$	Junction-to-Ambient ( PCB Mounted, steady-state)**	—	40	

## Electrical Characteristics @ $T_J = 25^\circ\text{C}$ (unless otherwise specified)

	Parameter	Min.	Typ.	Max.	Units	Conditions
$V_{(BR)DSS}$	Drain-to-Source Breakdown Voltage	150	—	—	V	$V_{GS} = 0V, I_D = 250\mu A$
$\Delta V_{(BR)DSS}/\Delta T_J$	Breakdown Voltage Temp. Coefficient	—	0.17	—	$V/^\circ\text{C}$	Reference to $25^\circ\text{C}$ , $I_D = 1\text{mA}$ ⑤
$R_{DS(on)}$	Static Drain-to-Source On-Resistance	—	—	0.042	$\Omega$	$V_{GS} = 10V, I_D = 22A$ ④
$V_{GS(th)}$	Gate Threshold Voltage	2.0	—	4.0	V	$V_{DS} = V_{GS}, I_D = 250\mu A$
$g_{fs}$	Forward Transconductance	19	—	—	S	$V_{DS} = 50V, I_D = 22A$ ⑤
$I_{DSS}$	Drain-to-Source Leakage Current	—	—	25	$\mu A$	$V_{DS} = 150V, V_{GS} = 0V$
		—	—	250		$V_{DS} = 120V, V_{GS} = 0V, T_J = 150^\circ\text{C}$
$I_{GSS}$	Gate-to-Source Forward Leakage	—	—	100	nA	$V_{GS} = 20V$
	Gate-to-Source Reverse Leakage	—	—	-100		$V_{GS} = -20V$
$Q_g$	Total Gate Charge	—	—	200	nC	$I_D = 22A$
$Q_{gs}$	Gate-to-Source Charge	—	—	17		$V_{DS} = 120V$
$Q_{gd}$	Gate-to-Drain ("Miller") Charge	—	—	98		$V_{GS} = 10V$ , See Fig. 6 and 13 ④⑤
$t_{d(on)}$	Turn-On Delay Time	—	12	—	ns	$V_{DD} = 75V$
$t_r$	Rise Time	—	55	—		$I_D = 22A$
$t_{d(off)}$	Turn-Off Delay Time	—	71	—		$R_G = 2.5\Omega$
$t_f$	Fall Time	—	69	—		$R_D = 3.3\Omega$ , See Fig. 10 ④⑤
$L_S$	Internal Source Inductance	—	7.5	—	nH	Between lead, and center of die contact
$C_{iss}$	Input Capacitance	—	2400	—	pF	$V_{GS} = 0V$
$C_{oss}$	Output Capacitance	—	640	—		$V_{DS} = 25V$
$C_{rss}$	Reverse Transfer Capacitance	—	340	—		$f = 1.0\text{MHz}$ , See Fig. 5⑤

## Source-Drain Ratings and Characteristics

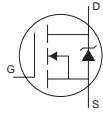
	Parameter	Min.	Typ.	Max.	Units	Conditions
$I_S$	Continuous Source Current (Body Diode)	—	—	43	A	MOSFET symbol showing the integral reverse p-n junction diode. 
$I_{SM}$	Pulsed Source Current (Body Diode) ①⑤	—	—	150		
$V_{SD}$	Diode Forward Voltage	—	—	1.3	V	$T_J = 25^\circ\text{C}, I_S = 22A, V_{GS} = 0V$ ④
$t_{rr}$	Reverse Recovery Time	—	260	390	ns	$T_J = 25^\circ\text{C}, I_F = 22A$
$Q_{rr}$	Reverse Recovery Charge	—	2.2	3.3	$\mu\text{C}$	$di/dt = 100A/\mu\text{s}$ ④⑤
$t_{on}$	Forward Turn-On Time	Intrinsic turn-on time is negligible (turn-on is dominated by $L_S + L_D$ )				

### Notes:

① Repetitive rating; pulse width limited by max. junction temperature. ( See fig. 11 )

④ Pulse width  $\leq 300\mu\text{s}$ ; duty cycle  $\leq 2\%$ .

② Starting  $T_J = 25^\circ\text{C}$ ,  $L = 2.4\text{mH}$   
 $R_G = 25\Omega$ ,  $I_{AS} = 22A$ . (See Figure 12)

⑤ Uses IRF3415 data and test conditions

③  $I_{SD} \leq 22A$ ,  $di/dt \leq 820A/\mu\text{s}$ ,  $V_{DD} \leq V_{(BR)DSS}$ ,  
 $T_J \leq 175^\circ\text{C}$

\*\* When mounted on 1" square PCB ( FR-4 or G-10 Material ).

For recommended soldering techniques refer to application note #AN-994.

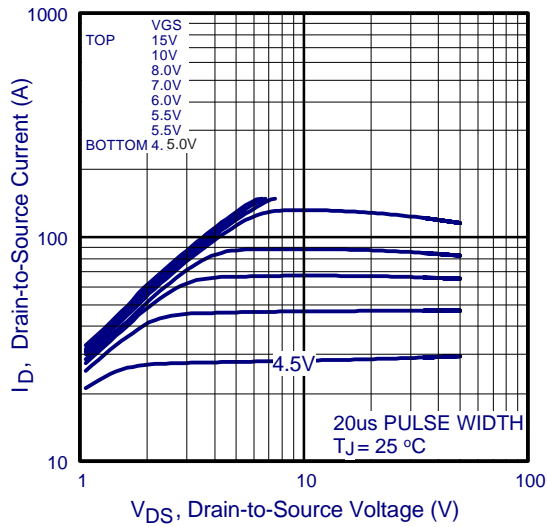

**Fig 1.** Typical Output Characteristics

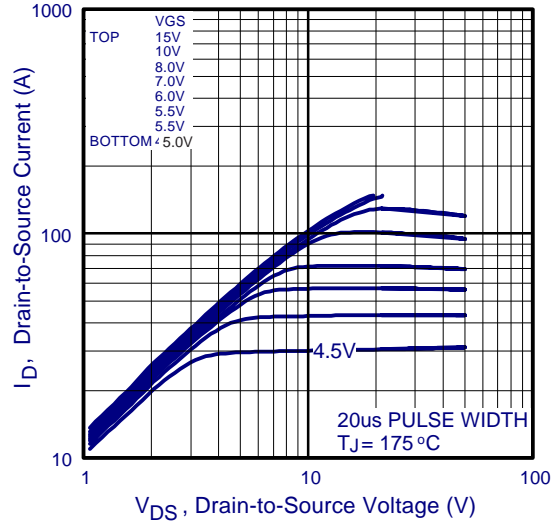

**Fig 2.** Typical Output Characteristics

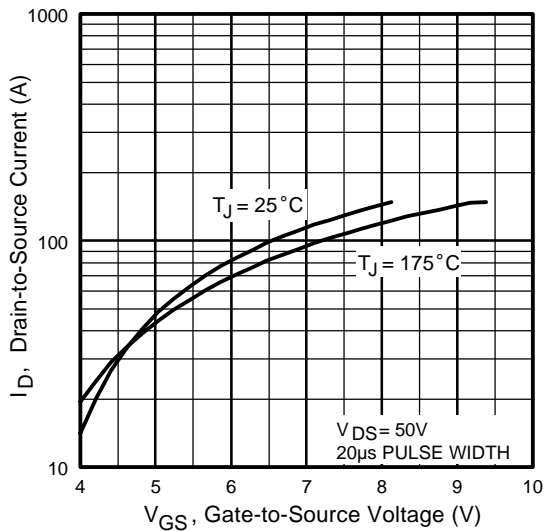

**Fig 3.** Typical Transfer Characteristics

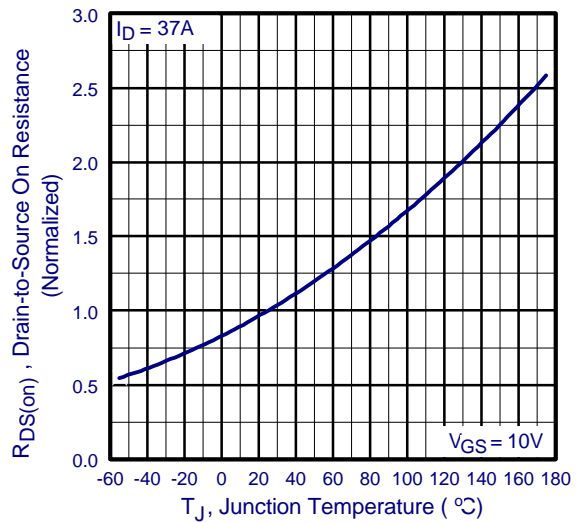

**Fig 4.** Normalized On-Resistance Vs. Temperature

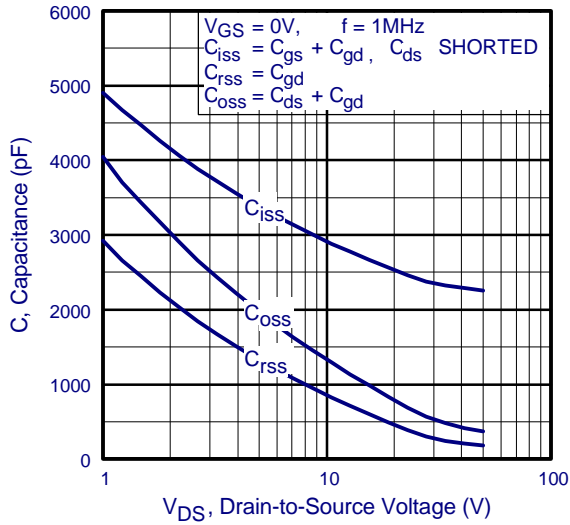

**Fig 5.** Typical Capacitance Vs. Drain-to-Source Voltage

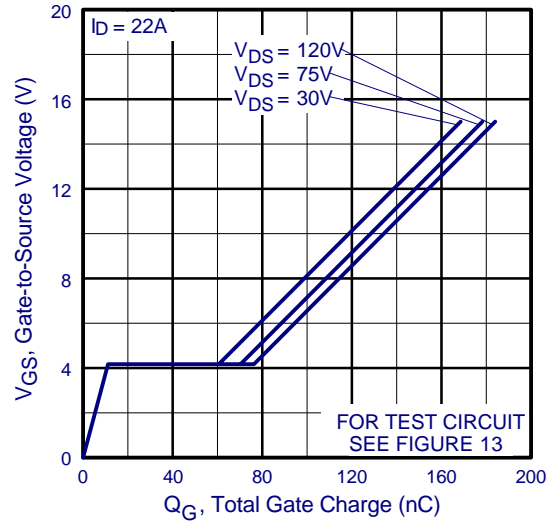

**Fig 6.** Typical Gate Charge Vs. Gate-to-Source Voltage

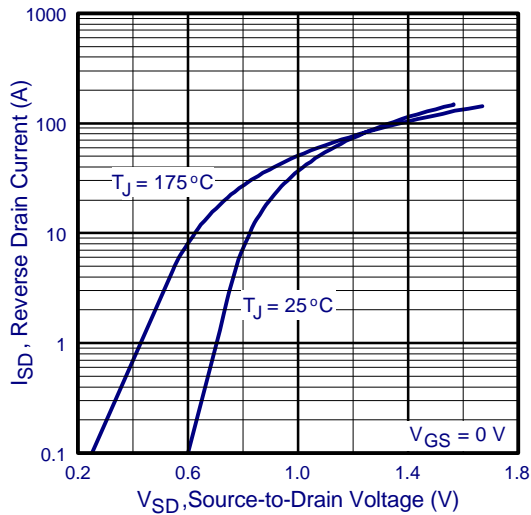

**Fig 7.** Typical Source-Drain Diode Forward Voltage

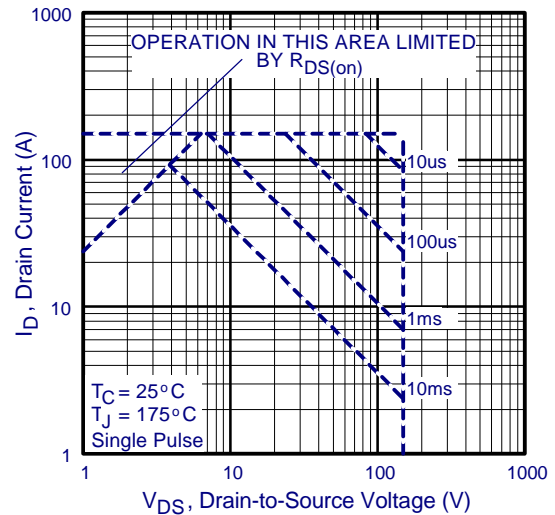

**Fig 8.** Maximum Safe Operating Area

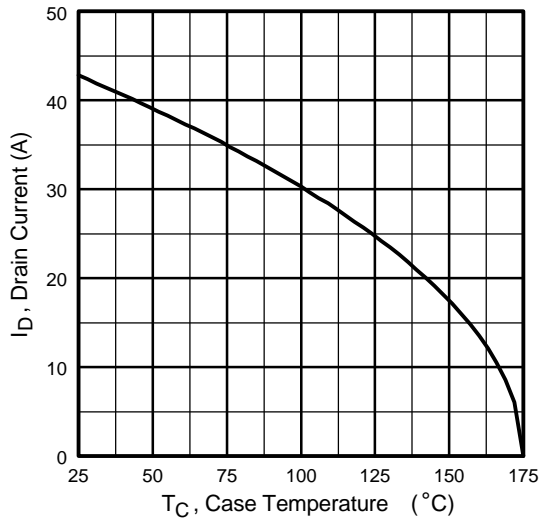

**Fig 9.** Maximum Drain Current Vs. Case Temperature

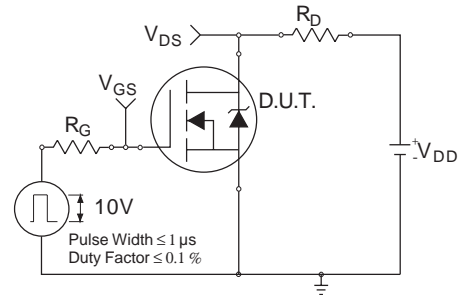

**Fig 10a.** Switching Time Test Circuit

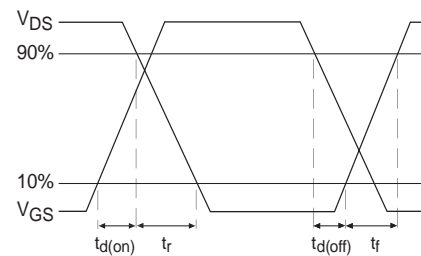

**Fig 10b.** Switching Time Waveforms

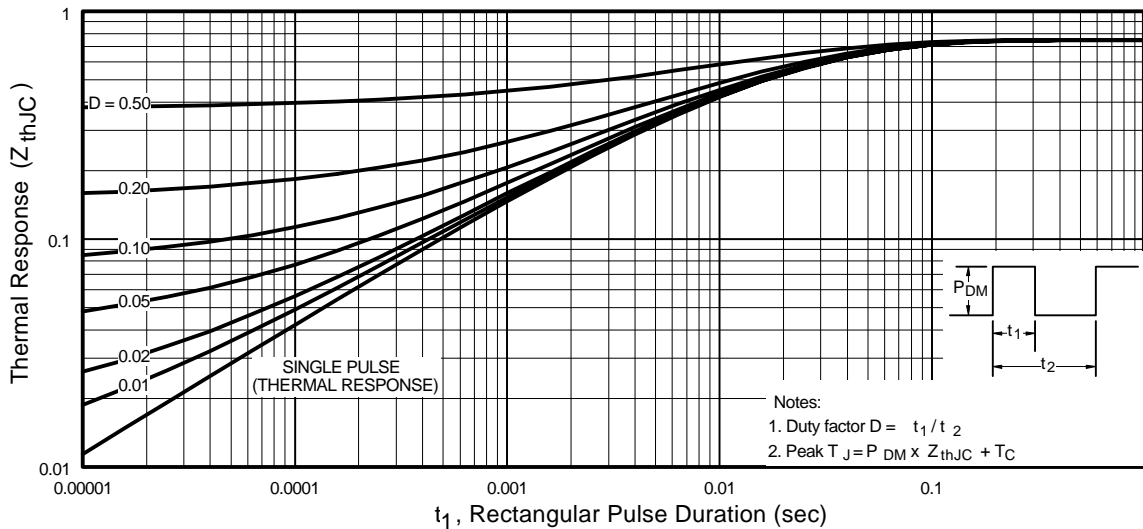

**Fig 11.** Maximum Effective Transient Thermal Impedance, Junction-to-Case

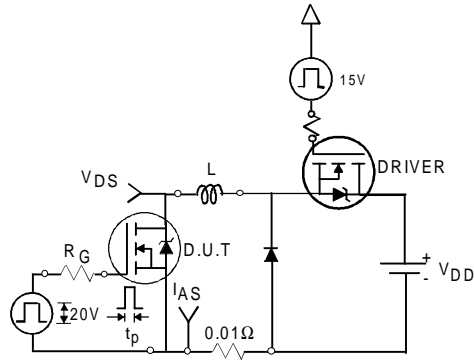

**Fig 12a.** Unclamped Inductive Test Circuit

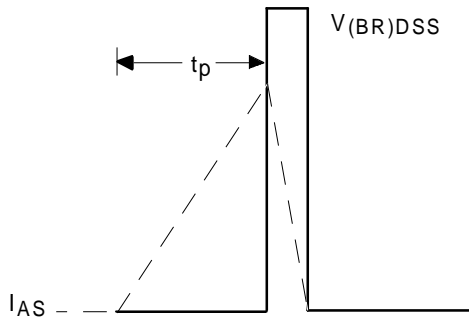

**Fig 12b.** Unclamped Inductive Waveforms

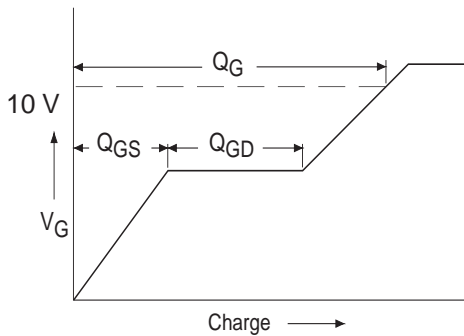

**Fig 13a.** Basic Gate Charge Waveform

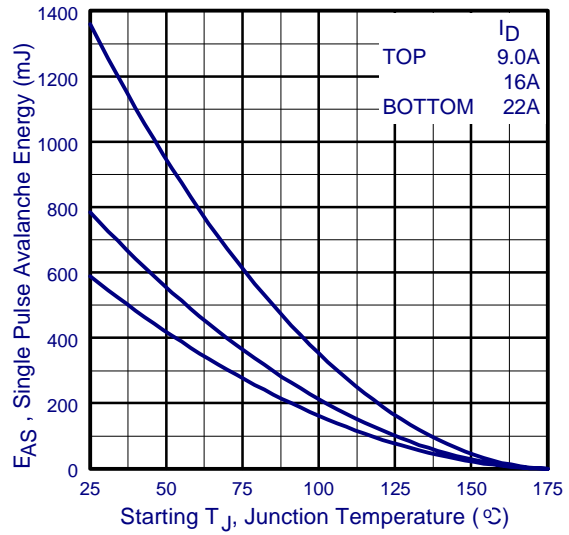

**Fig 12c.** Maximum Avalanche Energy Vs. Drain Current

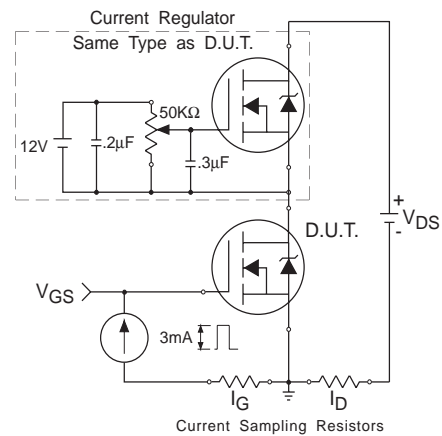

**Fig 13b.** Gate Charge Test Circuit

## Peak Diode Recovery dv/dt Test Circuit



\*  $V_{GS} = 5V$  for Logic Level Devices

**Fig 14.** For N-Channel HEXFETS

# IRF3415S/L

## D<sup>2</sup>Pak Package Outline

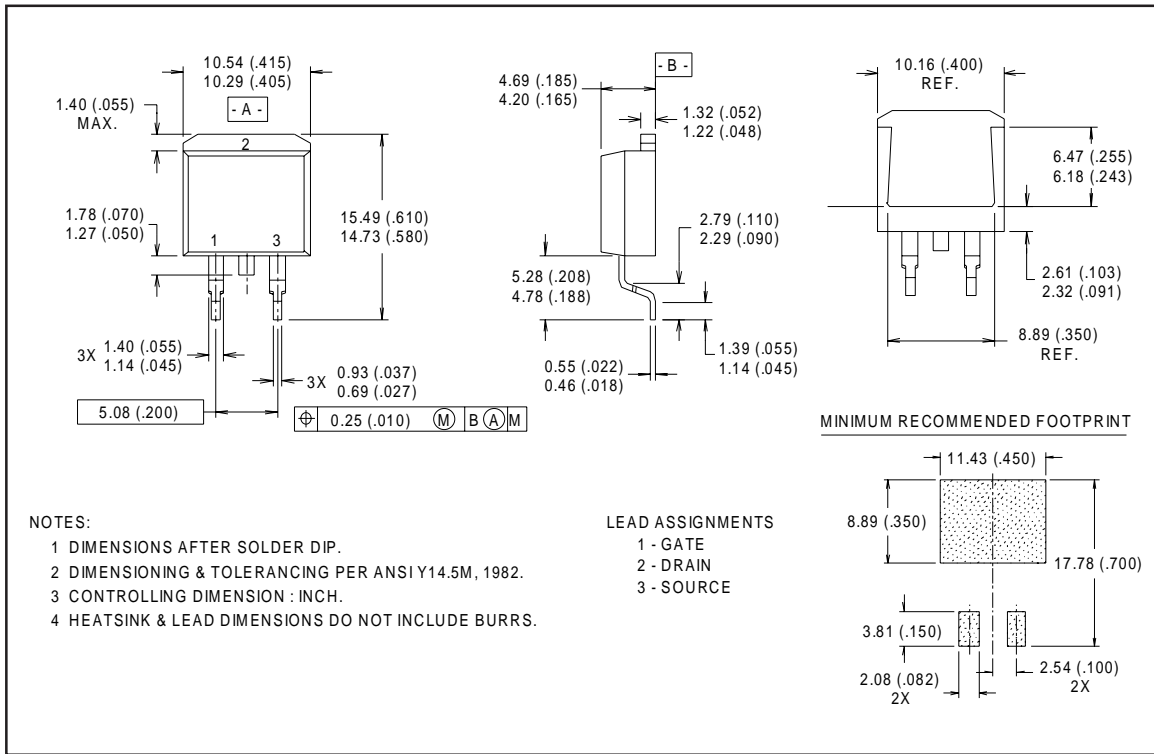

## Part Marking Information

### D<sup>2</sup>Pak

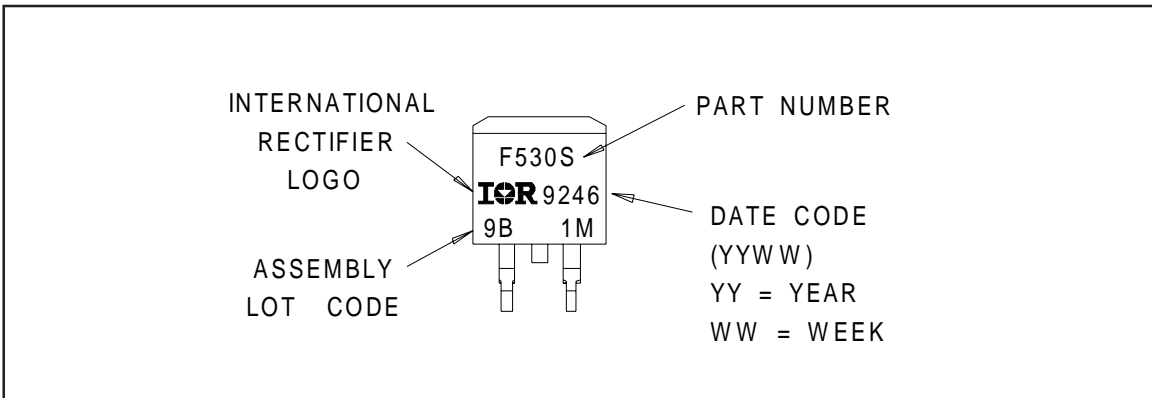



## Package Outline

### TO-262 Outline



## Part Marking Information

### TO-262

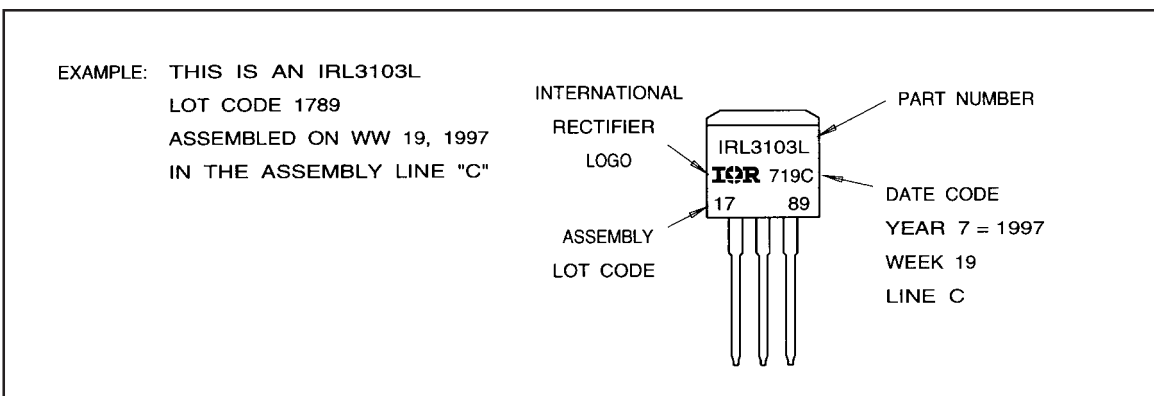

# IRF3415S/L

International  
**IR** Rectifier

## Tape & Reel Information

D<sup>2</sup>Pak

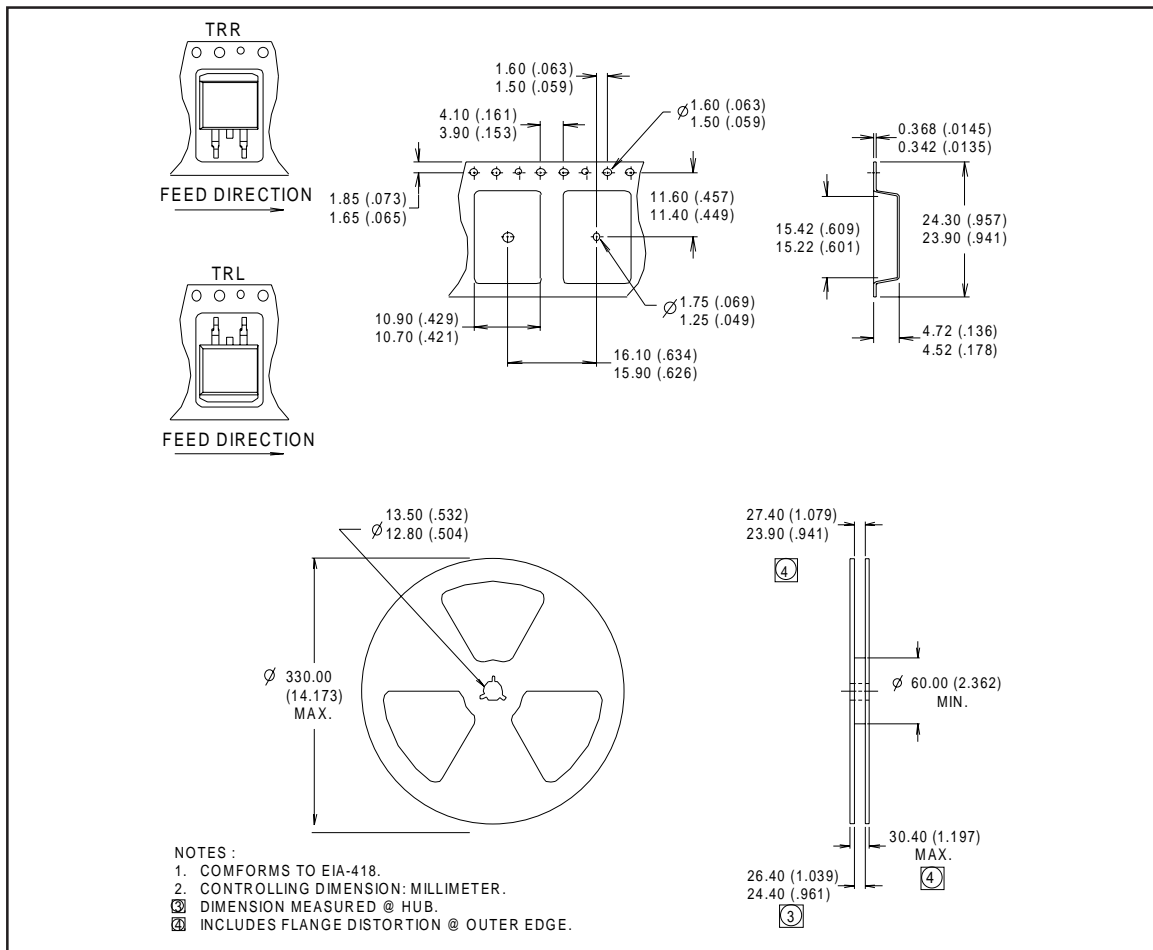

International  
**IR** Rectifier

**WORLD HEADQUARTERS:** 233 Kansas St., El Segundo, California 90245, Tel: (310) 322 3331  
**EUROPEAN HEADQUARTERS:** Hurst Green, Oxted, Surrey RH8 9BB, UK Tel: ++ 44 1883 732020

**IR CANADA:** 7321 Victoria Park Ave., Suite 201, Markham, Ontario L3R 2Z8, Tel: (905) 475 1897

**IR GERMANY:** Saalburgstrasse 157, 61350 Bad Homburg Tel: ++ 49 6172 96590

**IR ITALY:** Via Liguria 49, 10071 Borgaro, Torino Tel: ++ 39 11 451 0111

**IR FAR EAST:** K&H Bldg., 2F, 30-4 Nishi-Ikebukuro 3-Chome, Toshima-Ku, Tokyo Japan 171 Tel: 81 3 3983 0086

**IR SOUTHEAST ASIA:** 315 Outram Road, #10-02 Tan Boon Liat Building, Singapore 0316 Tel: 65 221 8371

<http://www.irf.com/> Data and specifications subject to change without notice. 5/98