

# International IOR Rectifier

## HFA04TB60S

HEXFRED™

Ultrafast, Soft Recovery Diode

### Features

- Ultrafast Recovery
- Ultrasoft Recovery
- Very Low  $I_{RRM}$
- Very Low  $Q_{rr}$
- Specified at Operating Conditions

### Benefits

- Reduced RFI and EMI
- Reduced Power Loss in Diode and Switching Transistor
- Higher Frequency Operation
- Reduced Snubbing
- Reduced Parts Count

### Description

International Rectifier's HFA04TB60S is a state of the art ultra fast recovery diode. Employing the latest in epitaxial construction and advanced processing techniques it features a superb combination of characteristics which result in performance which is unsurpassed by any rectifier previously available. With basic ratings of 600 volts and 8 amps per Leg continuous current, the HFA04TB60S is especially well suited for use as the companion diode for IGBTs and MOSFETs. In addition to ultra fast recovery time, the HEXFRED product line features extremely low values of peak recovery current ( $I_{RRM}$ ) and does not exhibit any tendency to "snap-off" during the  $t_b$  portion of recovery. The HEXFRED features combine to offer designers a rectifier with lower noise and significantly lower switching losses in both the diode and the switching transistor. These HEXFRED advantages can help to significantly reduce snubbing, component count and heatsink sizes. The HEXFRED HFA04TB60S is ideally suited for applications in power supplies and power conversion systems (such as inverters), motor drives, and many other similar applications where high speed, high efficiency is needed.

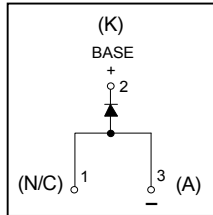

$$V_R = 600V$$

$$V_F = 1.8V$$

$$Q_{rr}^* = 40nC$$

$$di_{(rec)M}/dt^* = 280A/\mu s$$

\* 125°C

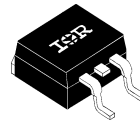

**D<sup>2</sup> Pak**

### Absolute Maximum Ratings

	Parameter	Max.	Units
$V_R$	Cathode-to-Anode Voltage	600	V
$I_F @ T_C = 100^\circ C$	Continuous Forward Current	4.0	A
$I_{FSM}$	Single Pulse Forward Current	25	
$I_{FRM}$	Maximum Repetitive Forward Current	16	
$P_D @ T_C = 25^\circ C$	Maximum Power Dissipation	25	W
$P_D @ T_C = 100^\circ C$	Maximum Power Dissipation	10	
$T_J$	Operating Junction and	-55 to +150	°C
$T_{STG}$	Storage Temperature Range		

# HFA04TB60S

Bulletin PD-20614 rev. A 12/00

International  

## Electrical Characteristics @ $T_J = 25^\circ\text{C}$ (unless otherwise specified)

	Parameter	Min.	Typ.	Max.	Units	Test Conditions
$V_{BR}$	Cathode Anode Breakdown Voltage	600	—	—	V	$I_R = 100\mu\text{A}$
$V_{FM}$	Max Forward Voltage	—	1.5	1.8	V	$I_F = 4.0\text{A}$
		—	1.8	2.2		$I_F = 8.0\text{A}$ See Fig. 1
		—	1.4	1.7		$I_F = 4.0\text{A}, T_J = 125^\circ\text{C}$
$I_{RM}$	Max Reverse Leakage Current	—	0.17	3.0	$\mu\text{A}$	$V_R = V_R$ Rated See Fig. 2
		—	44	300		$T_J = 125^\circ\text{C}, V_R = 0.8 \times V_R$ Rated
$C_T$	Junction Capacitance	—	4.0	8.0	pF	$V_R = 200\text{V}$ See Fig. 3
$L_S$	Series Inductance	—	8.0	—	nH	Measured lead to lead 5mm from package body

## Dynamic Recovery Characteristics @ $T_J = 25^\circ\text{C}$ (unless otherwise specified)

	Parameter	Min.	Typ.	Max.	Units	Test Conditions
$t_{rr}$	Reverse Recovery Time	—	17	—	ns	$I_F = 1.0\text{A}, di/dt = 200\text{A}/\mu\text{s}, V_R = 30\text{V}$ $T_J = 25^\circ\text{C}$
$t_{rr1}$	See Fig. 5 & 6	—	28	42		
$t_{rr2}$		—	38	57		
$I_{RRM1}$	Peak Recovery Current	—	2.9	5.2	A	$T_J = 25^\circ\text{C}$ $T_J = 125^\circ\text{C}$
		—	3.7	6.7		
$I_{RRM2}$	Reverse Recovery Charge	—	40	60	nC	$T_J = 25^\circ\text{C}$ $T_J = 125^\circ\text{C}$
$Q_{rr1}$	See Fig. 7	—	70	105		
$dI_{(rec)M}/dt1$	Peak Rate of Fall of Recovery Current	—	280	—	A/ $\mu\text{s}$	$T_J = 25^\circ\text{C}$ $T_J = 125^\circ\text{C}$
$dI_{(rec)M}/dt2$	During $t_b$ See Fig. 8	—	235	—		

## Thermal - Mechanical Characteristics

	Parameter	Min.	Typ.	Max.	Units
$T_{lead}$ ①	Lead Temperature	—	—	300	$^\circ\text{C}$
$R_{thJC}$	Thermal Resistance, Junction to Case	—	—	5.0	K/W
$R_{thJA}$ ②	Thermal Resistance, Junction to Ambient	—	—	80	
Wt	Weight	—	2.0	—	g
		—	0.07	—	(oz)

① 0.063 in. from Case (1.6mm) for 10 sec

② Typical Socket Mount

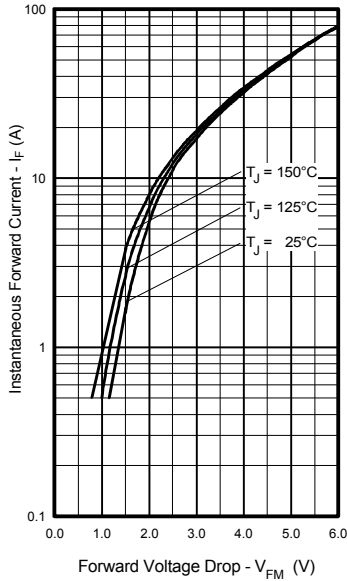

**Fig. 1** - Maximum Forward Voltage Drop vs. Instantaneous Forward Current,

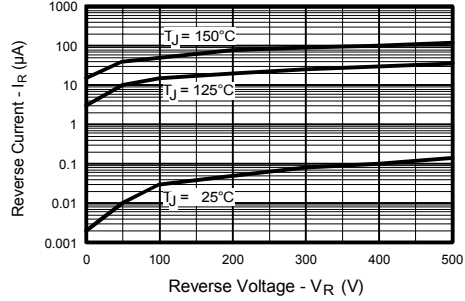

**Fig. 2** - Typical Reverse Current vs. Reverse Voltage

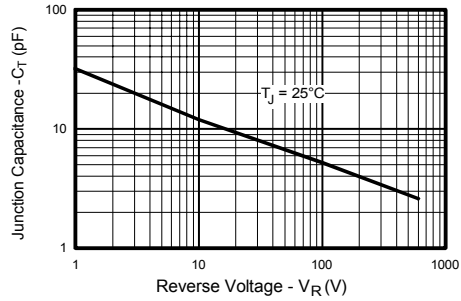

**Fig. 3** - Typical Junction Capacitance vs. Reverse Voltage

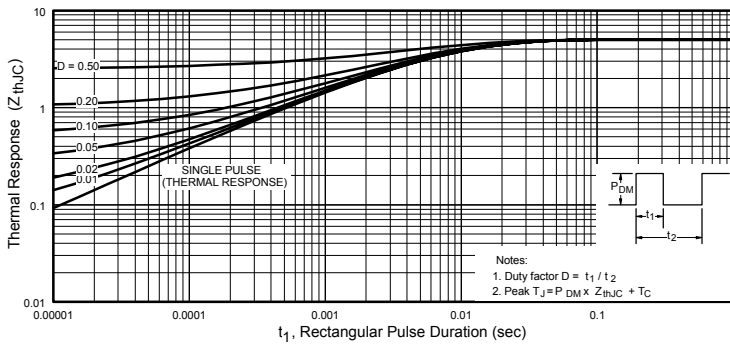

**Fig. 4** - Maximum Thermal Impedance  $Z_{thJC}$  Characteristics

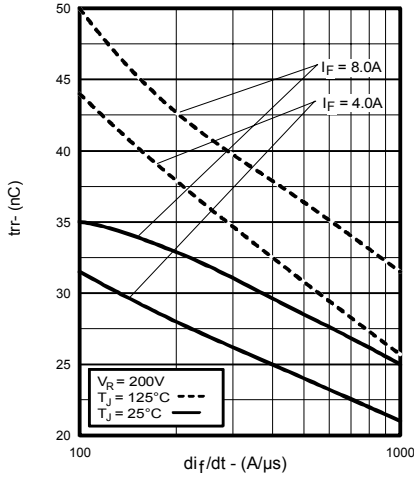

**Fig. 5 - Typical Reverse Recovery vs.  $di_f/dt$**

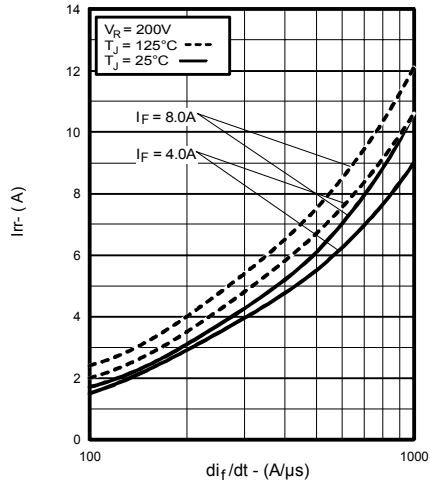

**Fig. 6 - Typical Recovery Current vs.  $di_f/dt$**

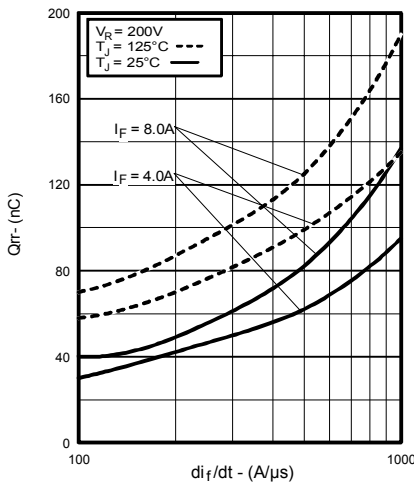

**Fig. 7 - Typical Stored Charge vs.  $di_f/dt$**

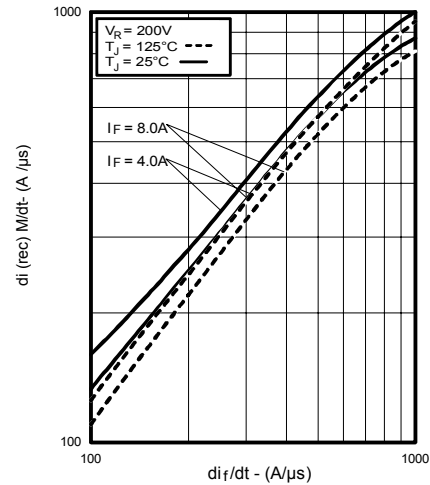

**Fig. 8 - Typical  $di_{(rec)}M/dt$  vs.  $di_f/dt$ ,**

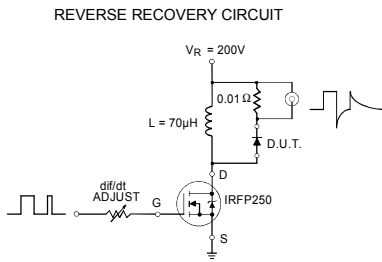

**Fig. 9 - Reverse Recovery Parameter Test Circuit**

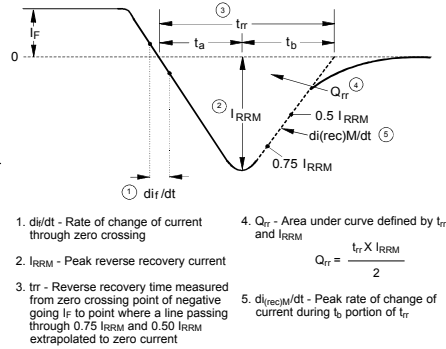

**Fig. 10 - Reverse Recovery Waveform and Definitions**

# HFA04TB60S

Bulletin PD-20614 rev. A 12/00

International  
**IGR** Rectifier

## Outline Table

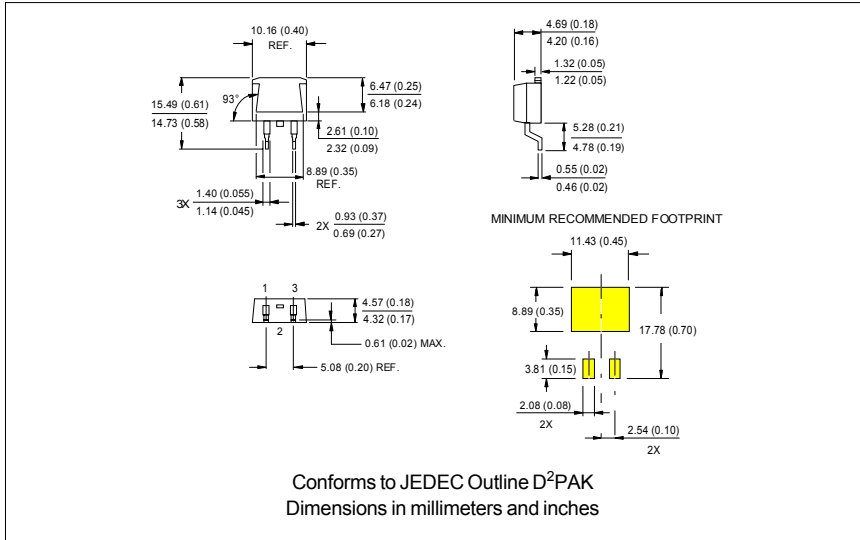

## Part Marking Information

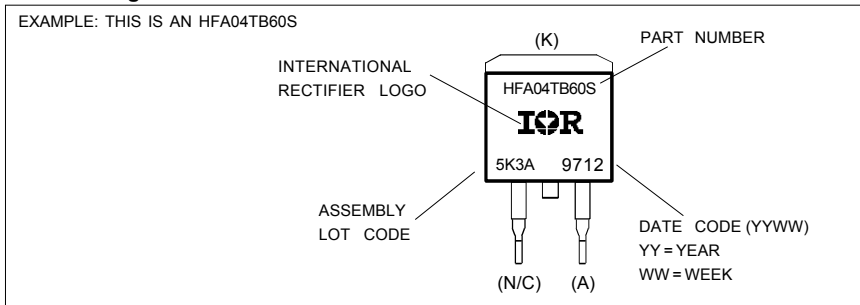

## Tape & Reel Information

