

NPN SILICON EPITAXIAL TRANSISTOR
POWER MINI MOLD

DESCRIPTION

The 2SC3357 is an NPN silicon epitaxial transistor designed for low noise amplifier at VHF, UHF and CATV band.

It has large dynamic range and good current characteristic.

FEATURES

- Low Noise and High Gain
 NF = 1.1 dB TYP., $G_a = 8.0$ dB TYP. @ $V_{CE} = 10$ V,
 $I_C = 7$ mA, $f = 1.0$ GHz
 NF = 1.8 dB TYP., $G_a = 9.0$ dB TYP. @ $V_{CE} = 10$ V,
 $I_C = 40$ mA, $f = 1.0$ GHz
- Large P_T in Small Package
 P_T : 2 W with $16 \text{ cm}^2 \times 0.7$ mm Ceramic Substrate.

ABSOLUTE MAXIMUM RATINGS ($T_A = 25^\circ\text{C}$)

Collector to Base Voltage	V_{CBO}	20	V
Collector to Emitter Voltage	V_{CEO}	12	V
Emitter to Base Voltage	V_{EBO}	3.0	V
Collector Current	I_C	100	mA
Total Power Dissipation	P_T^*	1.2	W
Thermal Resistance	$R_{th(j-a)}^*$	62.5	$^\circ\text{C/W}$
Junction Temperature	T_j	150	$^\circ\text{C}$
Storage Temperature	T_{stg}	-65 to +150	$^\circ\text{C}$

* mounted on $16 \text{ cm}^2 \times 0.7$ mm Ceramic Substrate

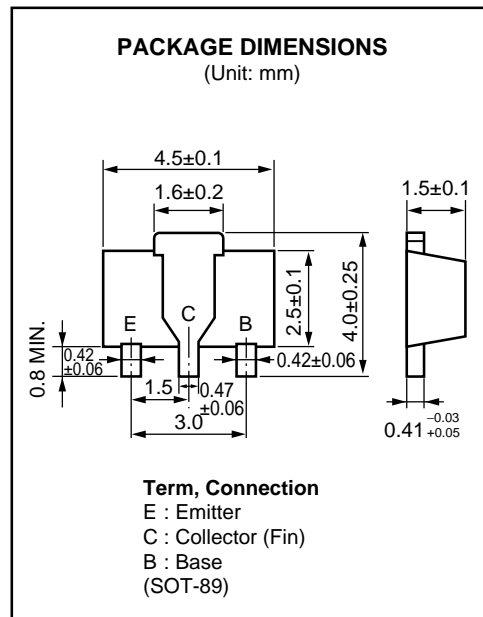

ELECTRICAL CHARACTERISTICS (T_A = 25 °C)

CHARACTERISTIC	SYMBOL	MIN.	TYP.	MAX.	UNIT	TEST CONDITIONS
Collector Cutoff Current	I _{CB0}			1.0	μA	V _{CB} = 10 V, I _E = 0
Emitter Cutoff Current	I _{EB0}			1.0	μA	V _{EB} = 1.0 V, I _C = 0
DC Current Gain	h _{FE} *	50	120	300		V _{CE} = 10 V, I _C = 20 mA
Gain Bandwidth Product	f _T		6.5		GHz	V _{CE} = 10 V, I _C = 20 mA
Feed-Back Capacitance	C _{re} **		0.65	1.0	pF	V _{CB} = 10 V, I _E = 0, f = 1.0 MHz
Insertion Power Gain	S _{21e} ²		9		dB	V _{CE} = 10 V, I _C = 20 mA, f = 1.0 GHz
Noise Figure	NF		1.1		dB	V _{CE} = 10 V, I _C = 7 mA, f = 1.0 GHz
Noise Figure	NF		1.8	3.0	dB	V _{CE} = 10 V, I _C = 40 mA, f = 1.0 GHz

* Pulse Measurement PW ≤ 350 μs, Duty Cycle ≤ 2 %

** The emitter terminal and the case shall be connected to the guard terminal of the three-terminal capacitance bridge.

h_{FE} Classification

Class	RH	RF	RE
Marking	RH	RF	RE
h _{FE}	50 to 100	80 to 160	125 to 250

TYPICAL CHARACTERISTICS (T_A = 25 °C)

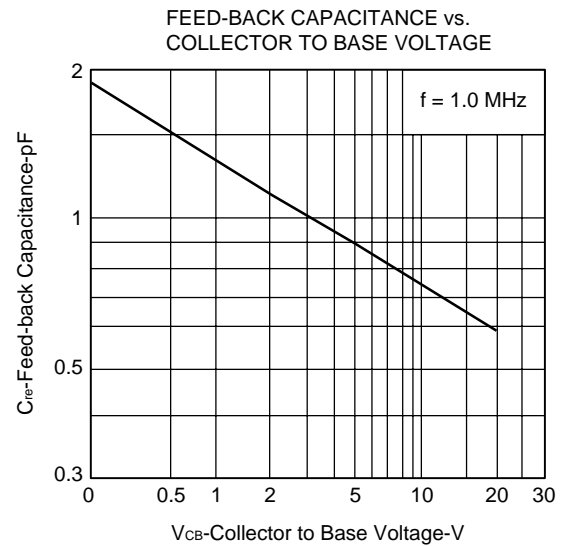
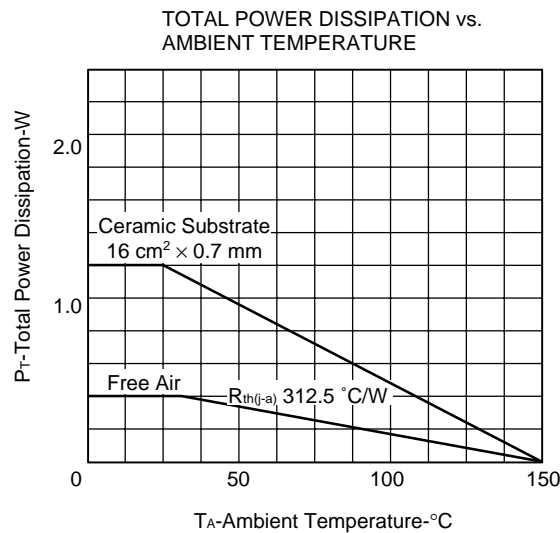

DC CURRENT GAIN vs. COLLECTOR CURRENT

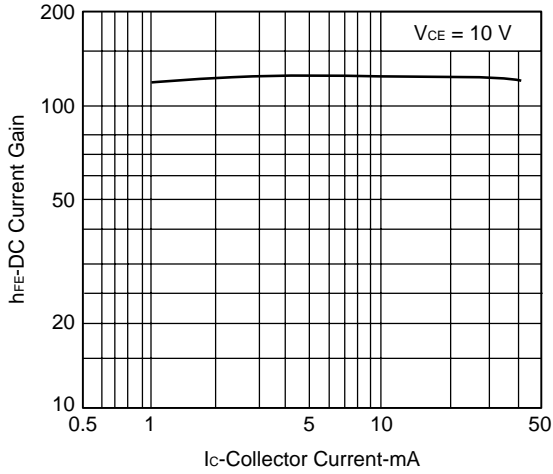

INSERTION GAIN vs. COLLECTOR CURRENT

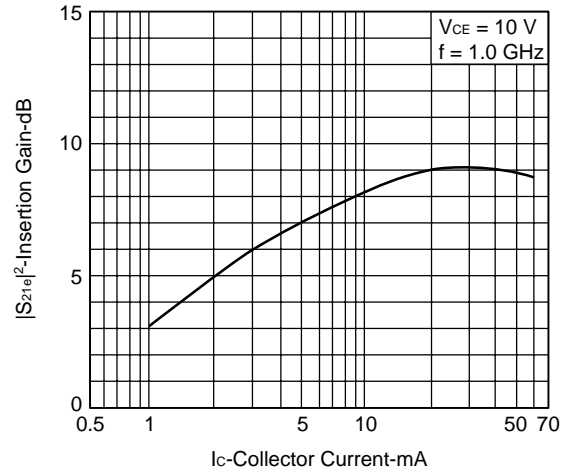

GAIN BANDWIDTH PROUDCT vs. COLLECTOR CURRENT

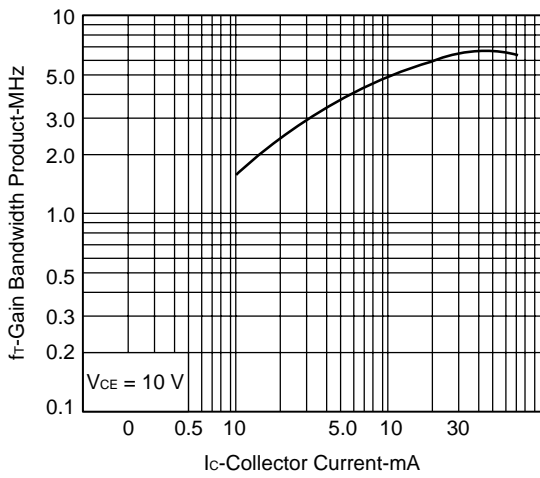

INSERTION GAIN, MAXIMUM GAIN vs. FREQUENCY

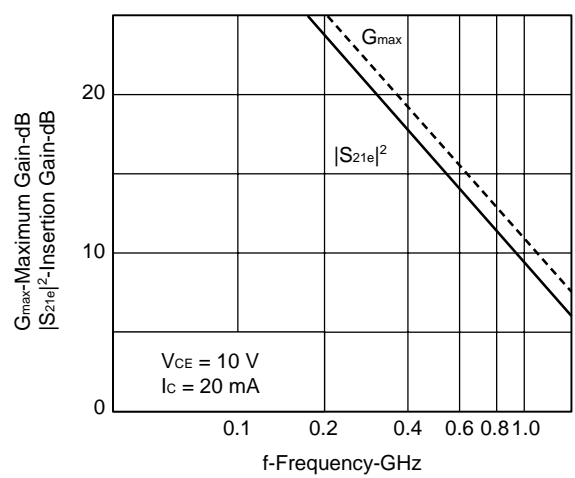

NOISE FIGURE vs. COLLECTOR CURRENT

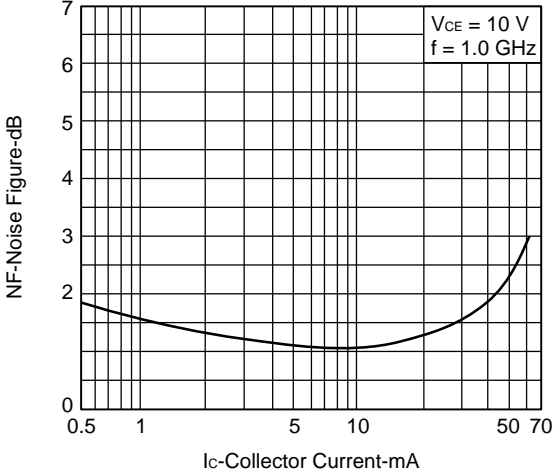

INTERMODULATION DISTORTION vs. COLLECTOR CURRENT

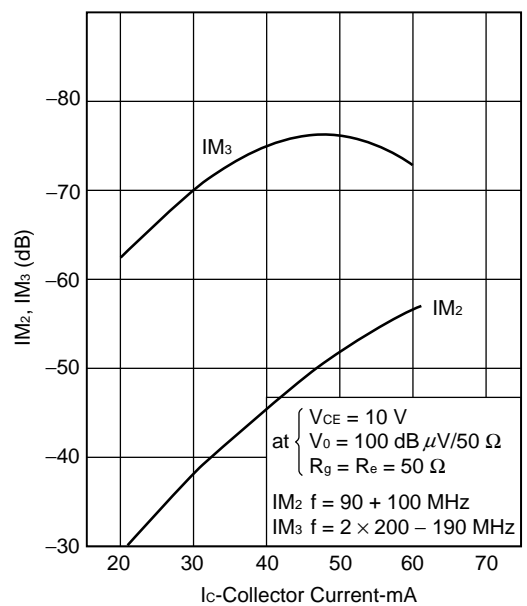

S-PARAMETER

$V_{CE} = 10\text{ V}$, $I_c = 40\text{ mA}$, $Z_o = 50\ \Omega$

f (MHz)	$ S_{11} $	$\angle S_{11}$	$ S_{21} $	$\angle S_{21}$	$ S_{12} $	$\angle S_{12}$	$ S_{22} $	$\angle S_{22}$
200	0.196	-94.4	13.023	102.4	0.043	74.5	0.444	-21.1
400	0.103	-118.3	6.852	89.2	0.081	77.4	0.398	-25.3
600	0.056	-131.1	4.632	78.3	0.118	77.5	0.399	-26.9
800	0.024	-43.7	3.527	75.9	0.152	78.0	0.414	-28.9
1000	0.008	-2.0	2.854	68.7	0.188	78.4	0.440	-33.5
1200	0.039	13.1	2.421	65.7	0.218	75.7	0.461	-33.3
1400	0.072	11.8	2.118	59.0	0.255	71.7	0.479	-36.3
1600	0.102	9.6	1.887	57.1	0.278	73.1	0.499	-35.5
1800	0.129	8.6	1.681	52.5	0.308	71.3	0.515	-38.8
2000	0.151	9.8	1.579	51.4	0.339	71.8	0.537	-35.9

$V_{CE} = 10\text{ V}$, $I_c = 20\text{ mA}$, $Z_o = 50\ \Omega$

f (MHz)	$ S_{11} $	$\angle S_{11}$	$ S_{21} $	$\angle S_{21}$	$ S_{12} $	$\angle S_{12}$	$ S_{22} $	$\angle S_{22}$
200	0.130	-109.2	13.430	98.1	0.042	79.0	0.403	-22.1
400	0.073	-134.1	6.930	87.2	0.081	80.6	0.382	-24.7
600	0.037	-146.6	4.690	79.4	0.119	79.4	0.392	-25.6
800	0.010	177.1	3.560	75.2	0.154	79.7	0.412	-27.1
1000	0.024	23.7	2.878	68.2	0.191	76.5	0.440	-31.9
1200	0.056	17.2	2.439	65.4	0.220	76.8	0.463	-32.3
1400	0.093	13.8	2.133	59.0	0.257	72.9	0.483	-35.7
1600	0.124	12.0	1.898	57.3	0.280	74.0	0.504	-35.3
1800	0.151	11.0	1.693	52.9	0.311	72.4	0.519	-38.4
2000	0.174	13.4	1.591	52.0	0.341	72.8	0.542	-36.3

S_{11e}, S_{22e}-FREQUENCY
 CONDITION V_{CE} = 10 V

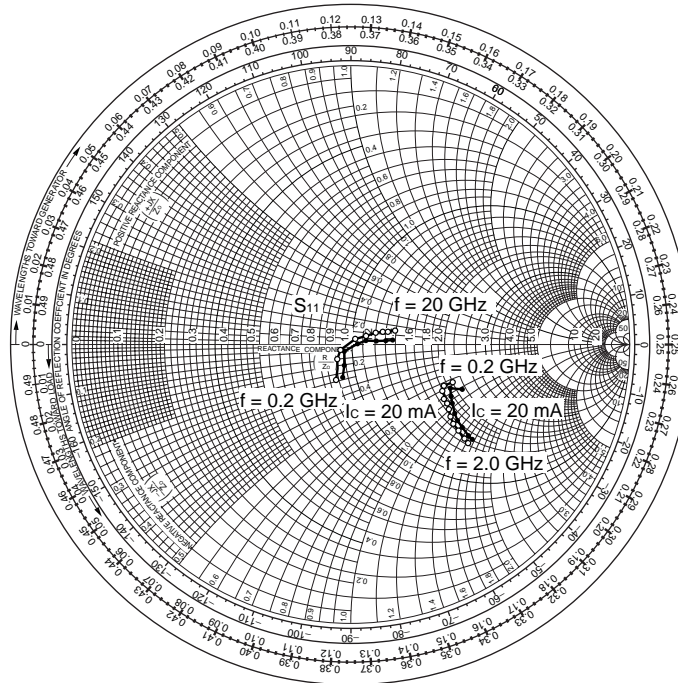

S_{21e}-FREQUENCY
 CONDITION V_{CE} = 10 V
 I_C = 20 mA

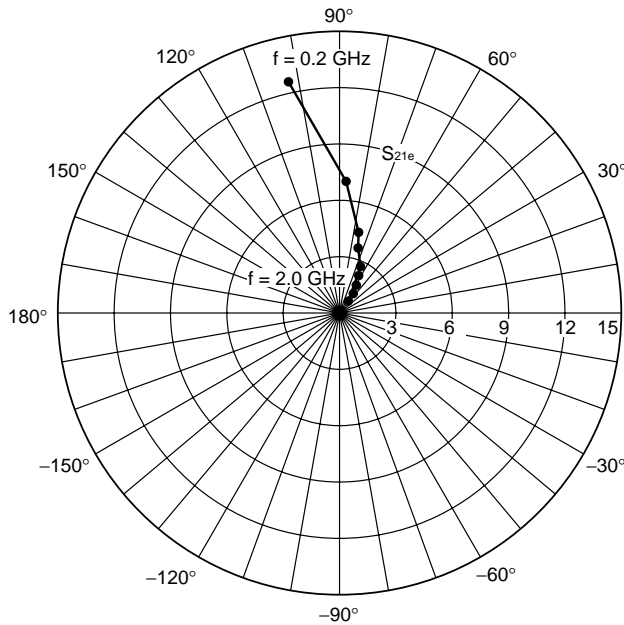

S_{12e}-FREQUENCY
 CONDITION V_{CE} = 10 V
 I_C = 20 mA

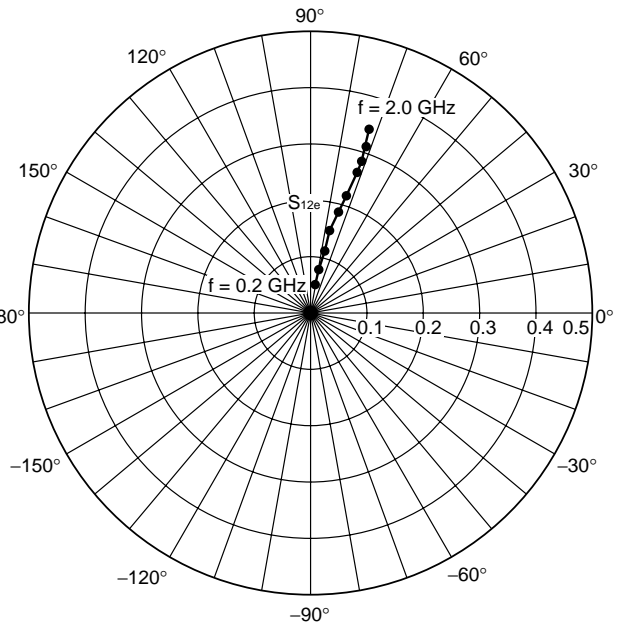

[MEMO]

[MEMO]

No part of this document may be copied or reproduced in any form or by any means without the prior written consent of NEC Corporation. NEC Corporation assumes no responsibility for any errors which may appear in this document.

NEC Corporation does not assume any liability for infringement of patents, copyrights or other intellectual property rights of third parties by or arising from use of a device described herein or any other liability arising from use of such device. No license, either express, implied or otherwise, is granted under any patents, copyrights or other intellectual property rights of NEC Corporation or others.

While NEC Corporation has been making continuous effort to enhance the reliability of its semiconductor devices, the possibility of defects cannot be eliminated entirely. To minimize risks of damage or injury to persons or property arising from a defect in an NEC semiconductor device, customers must incorporate sufficient safety measures in its design, such as redundancy, fire-containment, and anti-failure features.

NEC devices are classified into the following three quality grades:

"Standard", "Special", and "Specific". The Specific quality grade applies only to devices developed based on a customer designated "quality assurance program" for a specific application. The recommended applications of a device depend on its quality grade, as indicated below. Customers must check the quality grade of each device before using it in a particular application.

Standard: Computers, office equipment, communications equipment, test and measurement equipment, audio and visual equipment, home electronic appliances, machine tools, personal electronic equipment and industrial robots

Special: Transportation equipment (automobiles, trains, ships, etc.), traffic control systems, anti-disaster systems, anti-crime systems, safety equipment and medical equipment (not specifically designed for life support)

Specific: Aircrafts, aerospace equipment, submersible repeaters, nuclear reactor control systems, life support systems or medical equipment for life support, etc.

The quality grade of NEC devices is "Standard" unless otherwise specified in NEC's Data Sheets or Data Books. If customers intend to use NEC devices for applications other than those specified for Standard quality grade, they should contact an NEC sales representative in advance.

Anti-radioactive design is not implemented in this product.