

## NPN Silicon Transistors With High Reverse Voltage

**BF 420**  
**BF 422**

- High breakdown voltage
- Low collector-emitter saturation voltage
- Low capacitance
- Complementary types: BF 421, BF 423 (PNP)

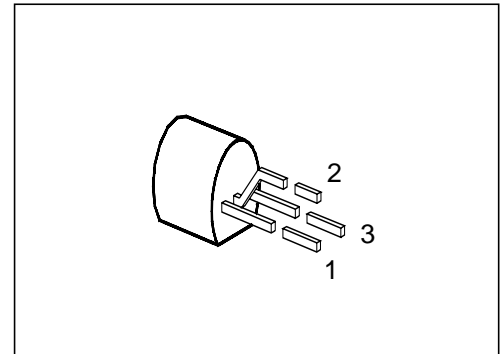

Type	Marking	Ordering Code	Pin Configuration			Package <sup>1)</sup>
			1	2	3	
BF 420 BF 422	–	Q62702-F531 Q62702-F495	E	C	B	TO-92

### Maximum Ratings

Parameter	Symbol	Values		Unit
		BF 420	BF 422	
Collector-emitter voltage	$V_{CE0}$	–	250	V
Collector-emitter voltage $R_{BE} = 2.7 \text{ k}$	$V_{CER}$	300	–	
Collector-base voltage	$V_{CB0}$	300	250	
Emitter-base voltage	$V_{EB0}$	5		
Collector current	$I_C$	50		mA
Peak base current	$I_{BM}$	100		
Total power dissipation, $T_C = 88 \text{ °C}$	$P_{tot}$	830		mW
Junction temperature	$T_j$	150		
Storage temperature range	$T_{stg}$	– 65 ... + 150		

### Thermal Resistance

Junction - ambient	$R_{th \text{ JA}}$	$\leq 150$	K/W
Junction - case <sup>2)</sup>	$R_{th \text{ JC}}$	$\leq 75$	

<sup>1)</sup> For detailed information see chapter Package Outlines.

<sup>2)</sup> Mounted on Al heat sink 15 mm × 25 mm × 0.5 mm.

## Electrical Characteristics

at  $T_A = 25\text{ °C}$ , unless otherwise specified.

Parameter	Symbol	Values			Unit
		min.	typ.	max.	

### DC characteristics

Collector-emitter breakdown voltage $I_C = 1\text{ mA}$ BF 422	$V_{(BR)CE0}$	250	–	–	V
Collector-emitter breakdown voltage $I_C = 10\text{ }\mu\text{A}$ , $R_{BE} = 2.7\text{ k}$ BF 420	$V_{(BR)CER}$	300	–	–	
Collector-base breakdown voltage $I_C = 10\text{ }\mu\text{A}$ BF 420 BF 422	$V_{(BR)CB0}$	300 250	– –	– –	
Emitter-base breakdown voltage, $I_E = 10\text{ }\mu\text{A}$	$V_{(BR)EB0}$	5	–	–	
Collector cutoff current $V_{CB} = 200\text{ V}$	$I_{CB0}$	–	–	10	nA
Collector cutoff current $V_{CE} = 200\text{ V}$ , $R_{BE} = 2.7\text{ k}$ <sup>1)</sup> , $T_A = 150\text{ °C}$	$I_{CER}$	–	–	10	$\mu\text{A}$
Emitter cutoff current, $V_{EB} = 5\text{ V}$	$I_{EB0}$	–	–	10	
DC current gain $I_C = 100\text{ }\mu\text{A}$ , $V_{CE} = 20\text{ V}$ $I_C = 25\text{ mA}$ , $V_{CE} = 20\text{ V}$	$h_{FE}$	15 50	– –	– –	–
Collector-emitter saturation voltage <sup>1)</sup> $I_C = 25\text{ mA}$ , $T_j = 150\text{ °C}$	$V_{CEsatRF}$	–	–	20	V

### AC characteristics

Transition frequency $I_C = 10\text{ mA}$ , $V_{CE} = 10\text{ V}$ , $f = 20\text{ MHz}$	$f_t$	–	100	–	MHz
Output capacitance $V_{CB} = 30\text{ V}$ , $f = 1\text{ MHz}$	$C_{obo}$	–	0.8	–	pF

<sup>1)</sup> Pulse test:  $t \leq 300\text{ }\mu\text{s}$ ,  $D \leq 2\%$ .

**Total power dissipation  $P_{tot} = f(T_A; T_C)$**

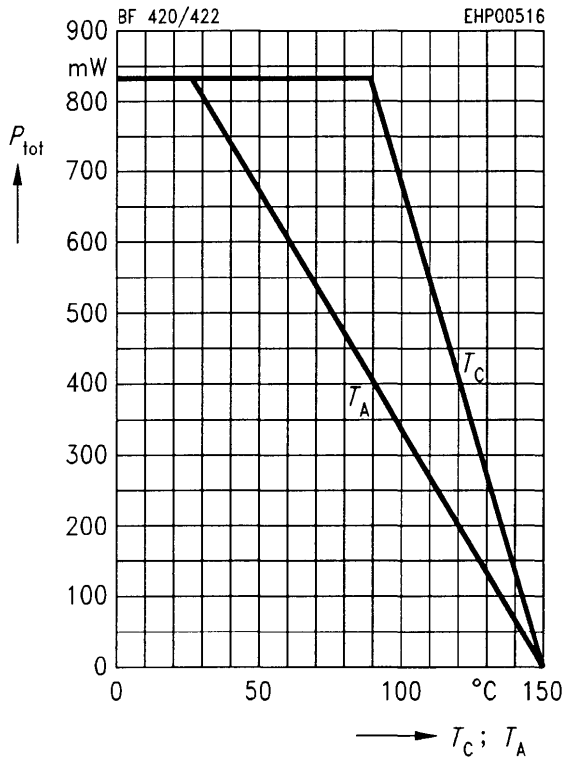

**Collector cutoff current  $I_{CB0} = f(T_A)$   
 $V_{CB} = 200$  V**

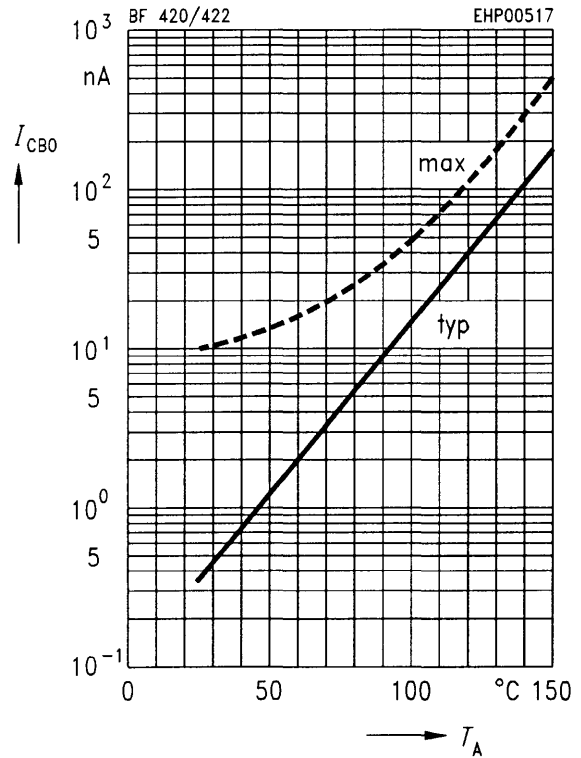

**Permissible pulse load  $R_{thJA} = f(t_p)$**

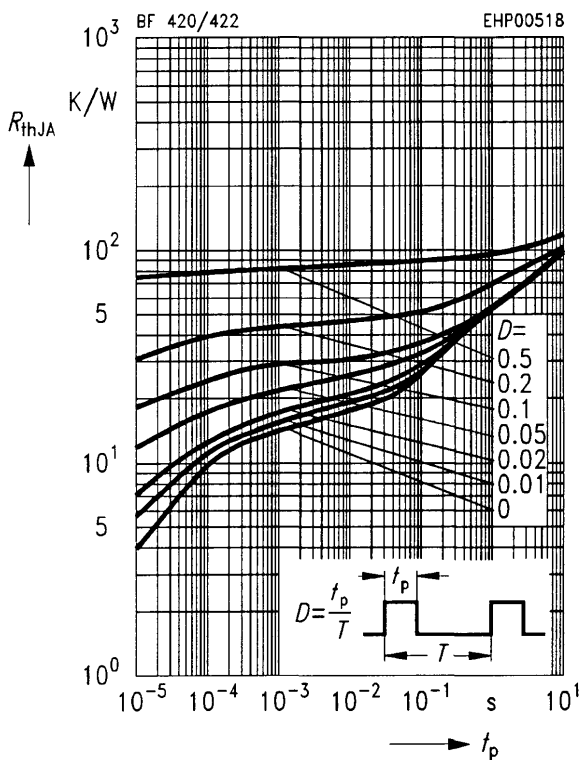

**Collector current  $I_C = f(V_{BE})$   
 $V_{CE} = 20$  V,  $T_A = 25$  °C**

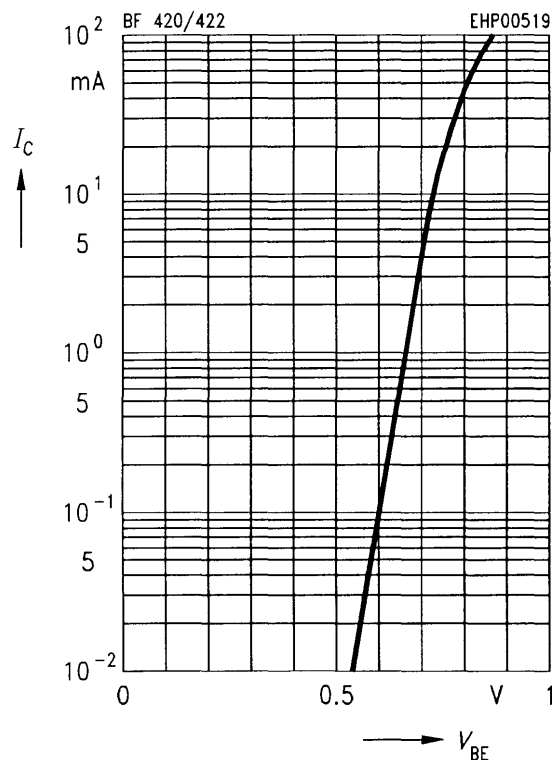

**DC current gain  $h_{FE} = f(I_C)$**

$V_{CE} = 20 \text{ V}, T_A = 25 \text{ }^\circ\text{C}$

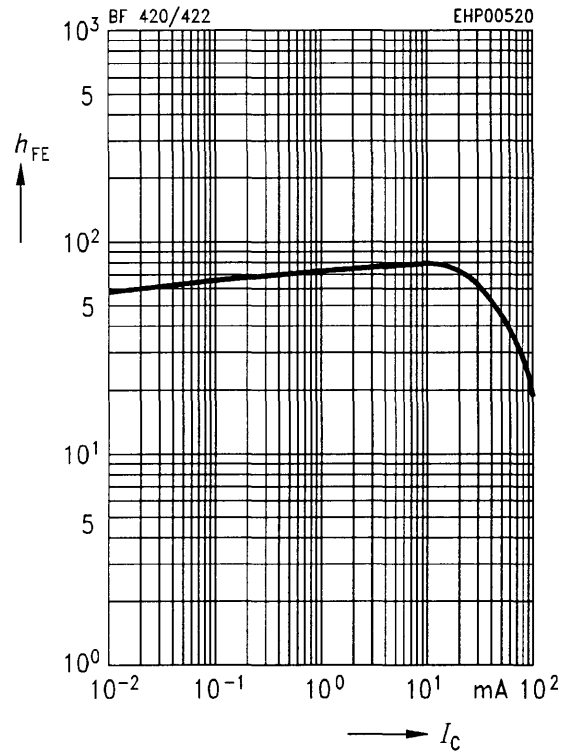

**Transition frequency  $f_T = f(I_C)$**

$V_{CE} = 10 \text{ V}, f = 20 \text{ MHz}$

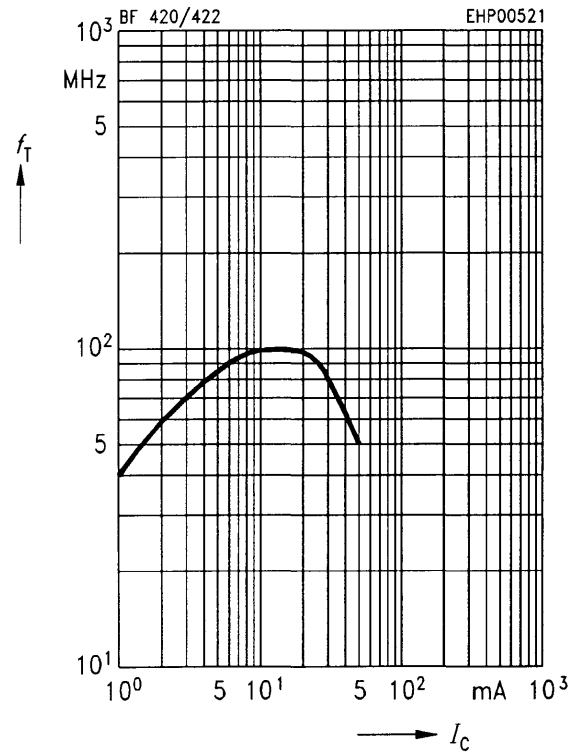

**Output capacitance  $C_{obo} = f(V_{CB})$**

$I_C = 0, f = 1 \text{ MHz}$

