

4N25X, 4N26X, 4N27X, 4N28X
4N25, 4N26, 4N27, 4N28



**OPTICALLY COUPLED
ISOLATOR
PHOTOTRANSISTOR OUTPUT**

APPROVALS

- UL recognised, File No. E91231
- 'X' SPECIFICATION APPROVALS
 - VDE 0884 in 3 available lead form :-
 - STD
 - G form
 - SMD approved to CECC 00802
 - Certified to EN60950 by the following Test Bodies :-
 - Nemko - Certificate No. P01102464
 - Fimko - Certificate No. FI18166
 - Semko - Reference No. 0202037/01-22
 - Demko - Certificate No. 311158-01
 - BSI approved - Certificate No. 8001

DESCRIPTION

The 4N25, 4N26, 4N27, 4N28 series of optically coupled isolators consist of infrared light emitting diode and NPN silicon photo transistor in a standard 6 pin dual in line plastic package.

FEATURES

- Options :-
 - 10mm lead spread - add G after part no.
 - Surface mount - add SM after part no.
 - Tape&reel - add SMT&R after part no.
- High Isolation Voltage (5.3kV_{RMS}, 7.5kV_{PK})
- All electrical parameters 100% tested
- Custom electrical selections available

APPLICATIONS

- DC motor controllers
- Industrial systems controllers
- Measuring instruments
- Signal transmission between systems of different potentials and impedances

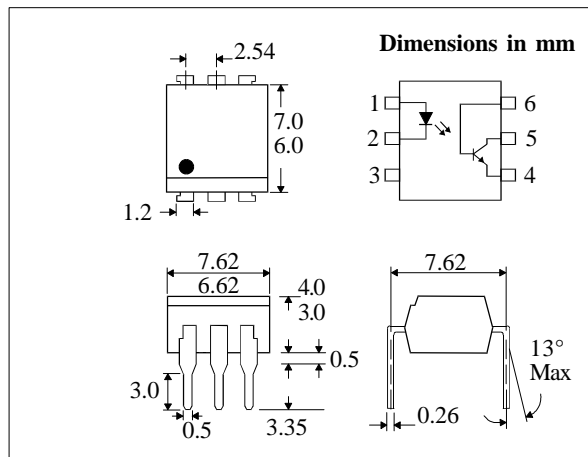
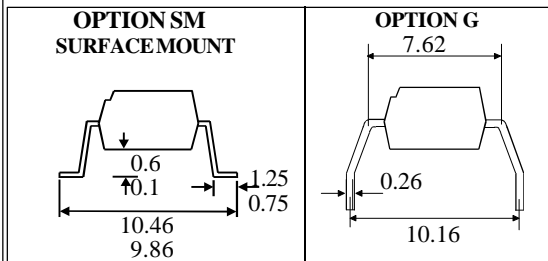

**ABSOLUTE MAXIMUM RATINGS
(25°C unless otherwise specified)**

Storage Temperature	-55°C to + 150°C
Operating Temperature	-55°C to + 100°C
Lead Soldering Temperature (1/16 inch (1.6mm) from case for 10 secs)	260°C

INPUT DIODE

Forward Current	60mA
Reverse Voltage	6V
Power Dissipation	105mW

OUTPUT TRANSISTOR

Collector-emitter Voltage BV_{CEO}	30V
Collector-base Voltage BV_{CBO}	70V
Emitter-collector Voltage BV_{ECO}	6V
Power Dissipation	160mW

POWER DISSIPATION

Total Power Dissipation	200mW
(derate linearly 2.67mW/°C above 25°C)	

ISOCOMCOMPONENTSLTD
Unit 25B, Park View Road West,
Park View Industrial Estate, Brenda Road
Hartlepool, TS25 1YD England Tel: (01429)863609
Fax: (01429) 863581 e-mail sales@isocom.co.uk
http://www.isocom.com

ISOCOM INC
1024 S. Greenville Ave, Suite 240,
Allen, TX 75002 USA
Tel: (214)495-0755 Fax: (214)495-0901
e-mail info@isocom.com
http://www.isocom.com

ELECTRICAL CHARACTERISTICS ($T_A = 25^\circ\text{C}$ Unless otherwise noted)

PARAMETER		MIN	TYP	MAX	UNITS	TEST CONDITION
Input	Forward Voltage (V_F)		1.2	1.5	V	$I_F = 10\text{mA}$
	Reverse Current (I_R)			10	μA	$V_R = 6\text{V}$
Output	Collector-emitter Breakdown (BV_{CEO}) (Note 2)	30			V	$I_C = 1\text{mA}$
	Collector-base Breakdown (BV_{CBO})	70			V	$I_C = 100\mu\text{A}$
	Emitter-collector Breakdown (BV_{ECO})	6			V	$I_E = 100\mu\text{A}$
	Collector-emitter Dark Current (I_{CEO})			50	nA	$V_{CE} = 10\text{V}$
	Collector-base Dark Current (I_{CBO})			20	nA	$V_{CE} = 10\text{V}$
Coupled	Current Transfer Ratio (CTR) 4N25, 4N26	20			%	$10\text{mA } I_F, 10\text{V } V_{CE}$
	4N27, 4N28	10			%	$10\text{mA } I_F, 10\text{V } V_{CE}$
	Collector-emitter Saturation Voltage $V_{CE(SAT)}$			0.5	V	$50\text{mA } I_F, 2\text{mA } I_C$
	Input to Output Isolation Voltage V_{ISO}	5300			V_{RMS}	See note 1
		7500			V_{PK}	See note 1
	Input-output Isolation Resistance R_{ISO}	5×10^{10}			Ω	$V_{IO} = 500\text{V}$ (note 1)
	Turn-on Time t_{on}		4		μs	$V_{CC} = 10\text{V},$ $I_F = 10\text{mA}, R_L = 100\Omega$ (FIG 1)
Turn-off Time t_{off}		3		μs		
Output Rise Time t_r		2		μs		
Output Fall Time t_f		2		μs		

Note 1 Measured with input leads shorted together and output leads shorted together.

Note 2 Special Selections are available on request. Please consult the factory.

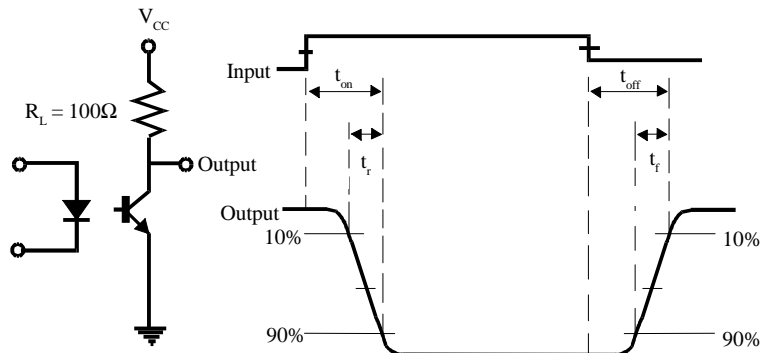
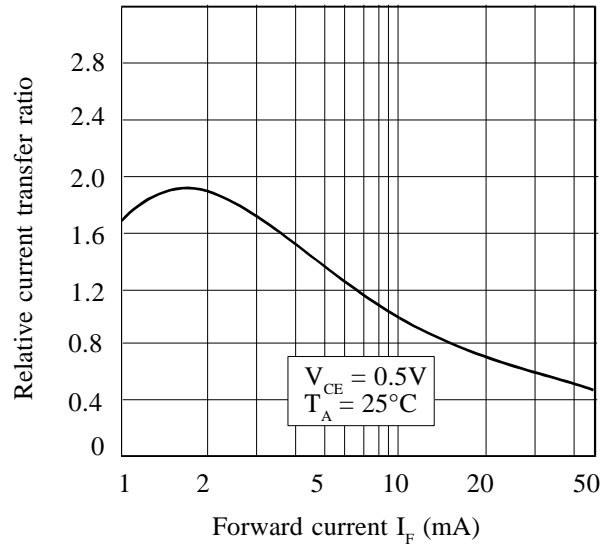

FIG 1

Collector Power Dissipation vs. Ambient Temperature



Relative Current Transfer Ratio vs. Forward Current



Forward Current vs. Ambient Temperature

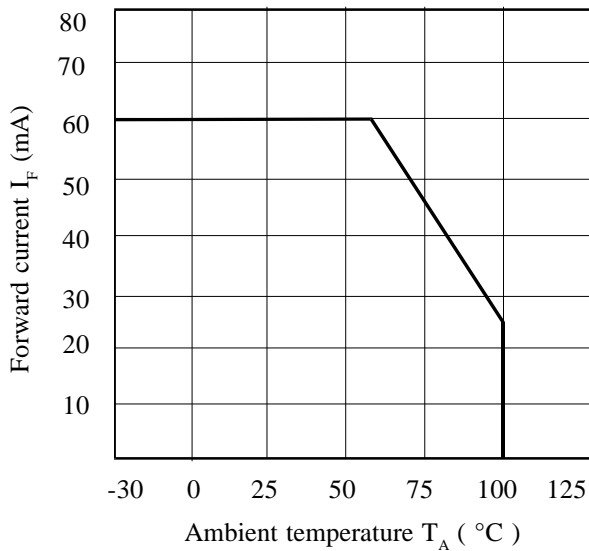

Relative Current Transfer Ratio vs. Forward Current

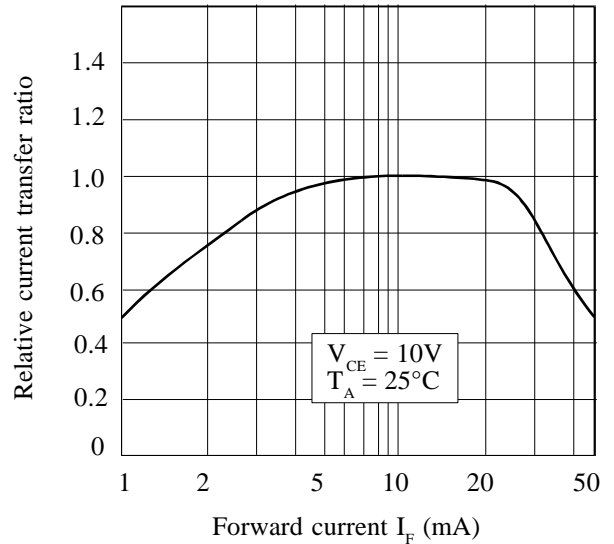

Relative Current Transfer Ratio vs. Ambient Temperature

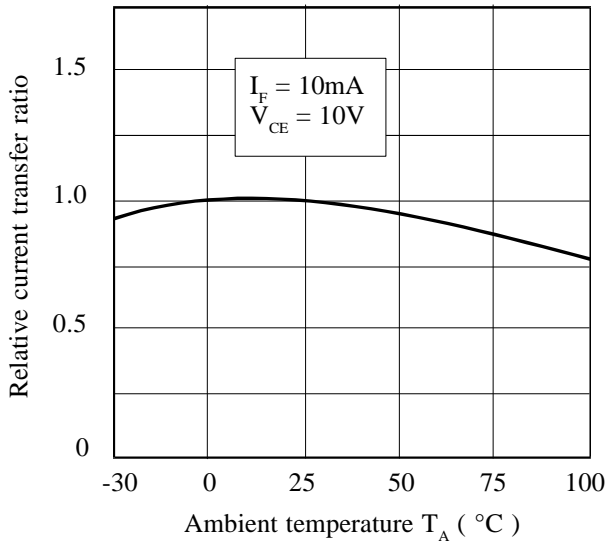

Collector-emitter Saturation Voltage vs. Ambient Temperature

